



# MANNED SUBMERSIBLES



Office of the Oceanographer of the Navy

2269





MBL/WHOI

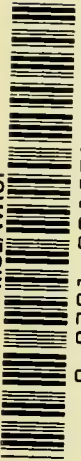

0 0301 0085791 8



Woods Hole Oceanographic Institution

Data Library  
Reference Collection

6  
B  
P

# **MANNED SUBMERSIBLES**

**BY**

**R. Frank Busby**

**OFFICE OF THE OCEANOGRAPHER  
OF THE NAVY**

**1976**

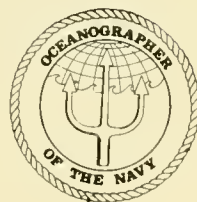



## **ROBERT PALMER BRADLEY**

September 3, 1930—November 28, 1973

Had I the chance to peel away the years and once again decide which path to follow, it would be towards the sea. I would do this for two reasons: Because it is a most intriguing subject and the most intriguing people are met on and under its surface. Bob Bradley was, what I can only call, a delight and a rare privilege to know. He possessed a sharp, sly sense of humor, a pioneer's sense of adventure and displayed a scholar's interest in the oceans. Naval aviator, commercial diver, submersible pilot and graduate in marine biology are not credentials one would expect from a son of the prairies. But in a quiet, certain, almost casual manner, Bob dealt as easily with the deep oceans as he would have the wheatfields of his native Kansas. He was quick to befriend, perhaps too quick, for the waters he felt he knew and understood claimed his life at 219 feet in Douglas Channel, British Columbia. I miss him; so do the other friends he left. In a very real sense, an earlier pioneer of the deep oceans, William Beebe, described our loss.

"When the last individual of a race of living things breathes no more, another heaven and another earth must pass before such a one can be again."

R. Frank Busby  
Arlington, Virginia  
January, 1975

# FOREWORD

History records evidence of insatiable human curiosity about our world. But it was a more urgent need than curiosity which tempted early man to look beneath the surface of the sea and test his limits of endurance. He went in search of natural treasure to augment his hard-won food supply and for naturally occurring materials that were useful in a primitive, comfortless routine of living. Limits were quickly reached in his invasion of the ocean depths, and all that lay beyond was called mysterious, remaining unapproachable without some form of protection against hostilities destructive to the fragile vehicle of human life.

Twentieth century technology has cleared the pathway for safe passage through those deep sea hostilities for an invasion of the marine environment unparalleled in history. A growing host of varied undersea vehicles is entering the ocean's depths in missions of science, engineering and exploration for industrial opportunity, as well as for the satisfaction of simple curiosity.

The U.S. Navy is required, by the responsibilities of its mission, to operate throughout the entire ocean environment. Those responsibilities, in turn, impose requirements for knowledge about our operational environment and technology that will operate there, effectively. In order to gain knowledge of the deep ocean and its influences upon naval operations, we have to go there. One way to go there is to send tools which function as extensions of man's senses and work capabilities. But, even though modern technology is helping us to develop increasingly refined instrumentation and methods for perceiving the nature of the ocean depths, there are observations and conclusions which cannot be achieved without the benefit of man's highly developed sensory capabilities operating in the immediate vicinity of investigation and work areas.

It is the manned submersible which offers us the opportunity to be on the scene and perform tasks in a relatively comfortable and secure environment at ocean depths or locations which would otherwise be destructive to human life. The Navy has developed a small family of manned submersibles to investigate the deep ocean and to perform various kinds of work included in the Navy's mission. We are also interested to know what others have done in the development of manned submersibles, because each effort in the field is helpful in solving problems of how to work most effectively in the deep ocean environment.

Our Nation . . . indeed, the whole world . . . has demonstrated renewed interest in developing the technology and the methods necessary to begin harvesting natural resources from the sea, in quantity. Amateurs as well as professionals are at work to design and build vehicles of one kind or another which will permit useful work in the ocean. Progress toward those goals is assisted by sharing both successes and failures in development efforts. The problems of reaching those goals are based on the difficulties of creating technology that works in the deep ocean. But the problems are basically the same no matter what kind of work is contemplated so a sharing of them and their solutions works to speed progress for all.

Because of escalating interest in what is required to accomplish useful work in the ocean environment, questions are being asked about manned submersibles: How do they work? Are there laws that govern their construction and employment? What are they capable of doing? If they are involved in an emergency what can be done to assist them? What are their limitations and their capabilities? Mr. Busby has compiled a comprehensive review of the development and operation of manned submersibles, providing the marine scientist, engineer and surveyor . . . as well as the uninitiated explorer of the ocean depths . . . with many answers to questions about these unique vehicles.

It is the Navy's intent to encourage a wider and more productive exchange of information concerning the requirements for performing useful work in the deep ocean and information about recorded achievements in design and operation of manned submersibles. Mr. Busby's efforts in collecting and presenting the information within the following pages have contributed greatly to such exchanges among present day and future participants in ocean programs that we all hope will some day deliver, to a waiting world, a realization of the age-old promise of resources from the sea.

**Rear Admiral J. Edward Snyder,  
USN**

**Oceanographer of the Navy**



# ACKNOWLEDGEMENTS

My sincerest appreciation is extended to CAPT Edward Clausner, Jr., USN (Ret.), formerly of the Navy Material Command, who found the time to listen to my pleas for support and, subsequently, provided the resources to fund this effort. He reviewed several of its chapters, opened many doors to information and, finally, still manages a smile after one and one-half years of near-continual pestering.

Secondly, my thanks and appreciation are tendered to CAPT Jack Boller, USN (Ret.), now Executive Secretary of the Marine Board of the National Academy of Engineering. CAPT Boller's support and advice were instrumental in seeing this work reach fruition.

I am indebted to Rear Admiral J. Edward Snyder, Jr., USN, Oceanographer of the Navy. His kindness and hospitality in providing me with working space and office facilities, during my tenure with CAPT Clausner, was boundless. I am further indebted to Admiral Snyder for allowing me to use the name of his office in the many requests to private and government institutions for information.

Although he was not directly involved with the preparation or funding of this work, Mr. John Perry, President and founder of Perry Submarine Builders, has contributed to its content since 1965. Through his gracious hospitality, the Perry staff, their submersibles and shops, have been my practical primer for almost a decade. In the course of this education, Mr. Perry kindly and indulgently stood by while I stumbled through the frustrating process of finding out what wouldn't work underwater and managed to keep a straight face while I attached the latest in undersea navigation devices: A bicycle wheel, to his *PC-3B*. In the course of such neophyte shenanigans, Mr. Perry has persevered through some difficult times to place manned submersibles in the category of practical and useful "work" boats, rather than expensive engineering toys.

Some 4,000 miles to the northwest of the Perry shops is the firm of International Hydrodynamics Ltd. (HYCO), founded by three commercial divers, Mack Thompson, Al Trice and Don Sorte, of Vancouver, B.C. Likewise, these three opened their shops and files to me and provided any and all information on their *PISCES* class submersible. In particular, I would like to express my appreciation to Mack Thompson, a practical, imaginative, ingenious, submersible designer and manufacturer who responded to every request of mine and made the time available for me to participate in dives on the *PISCES III*. The hospitality of the HYCO staff made every visit to Canada a rewarding and memorable occasion.

Now, my reviewers, E. W. Seabrook Hull, as my editor, reviewed this manuscript and restructured the narration to the English language and the reasoning to that of a relative sanity. Mr. Lloyd Wilson of the Naval Oceanographic Office took on the laborious chore of reviewing the first proof print. With patience and skill he corrected the hundreds of inconsistencies and spelling errors while imposing a sense of discipline to an exceptionally rambling narration. The following people kindly and most thoroughly reviewed individual chapters for technical accuracy: CAPT R. K. R. Worthington, USN, (Ret.), the *DEEP QUEST*

Submersible System Operations Officer; Mr. Jamie Farriss, Office of the Oceanographer of the Navy; Messrs. Larry Shumaker, and William O. Rainnie, Jr., WHOI; Mr. William Greenert, Naval Material Command; Messrs. Ronald Proventure, William Louis, and Gary North, Naval Ship Engineering Center; Mr. John Purcell, Naval Ship Systems Command; Dr. R. C. Bornmann, CAPT, USN, Bureau of Medicine and Surgery; Mr. Martin Fagot, U.S. Naval Oceanographic Office; Mr. Matthew J. Letich, American Bureau of Shipping; LCDR Ian Cruickshank and LT Richard Peyzer, U.S.C.G., and Mr. F. D. "Don" Barnett, Perry Submarine Builders.

I am particularly indebted to John Purcell and Don Barnett. In the face of numerous and frequent requests for data, photographs, advice and explanations, time and again did Mr. Purcell produce precisely what I needed or led me to individuals who could and did. Drawing on Mr. Barnett's wide range of experience with *TRIESTE I*, the *STAR* vehicles, *ALUMINAUT* and the Perry vehicles, I received an education in the operating and design philosophies of both private and government submersible activities.

A host of individuals provided information and photographs of their submersible design and construction; specifically the following were most helpful and patient in dealing with my many requests: Douglas N. Privitt, General Oceanographics; Terry Thompson, T. Thompson Ltd.; Donald Morcombe, Horton Maritime Exploration, Ltd.; Donald B. Bline, Westinghouse Ocean Research Laboratory; Donald Saner, Lockheed Missiles and Space Corp.; Robert McGratten, Electric Boat Div., Gen. Dyn. Corp.; A. Pete Ianuzzi, Naval Facilities Engineering Command; William C. W. Haines, All Ocean Industries Corp.; CAPT Edward E. Hennifen, Officer of the Chief of Naval Operations; CDR Robert F. Nevin, USN and Joseph R. Vadus, Manned Undersea Technology Program, NOAA; Dr. Andres Rechnitzer, Office of the Oceanographer of the Navy; Roger Cook, Operations Officer, *JOHNSON SEA LINK*; Paul Dostal, Alvin, Texas; John La Cerda and Mike Witt, Perry Submarine Builders; Donald Johnson, Naval Ship Systems Command; Thomas Horton, Living Sea Corp.; Robert Watts, Naval Undersea Research and Development Center; Burtis L. Dickman, Auburn, Ind.; C. Richards Vincent, Houston, Texas and D. W. Murphy, Hawaii Lab., Naval Undersea Center.

The majority of illustrations were reproduced from various transactions of the Marine Technology Society's annual meetings; in this regard I would like to express my appreciation to the Society and Mr. Robert Niblock, its former Executive Director, for granting permission to reproduce its material.

Information on non-U.S. submersibles was mainly obtained by writing one or several individuals from various countries who found the time and patience to answer another of the many "please tell me all you can about" letters that owners and operators of submersibles receive. My gratitude and appreciation is extended to the Kenneth R. Haigh, Admiralty Experimental Diving Unit and G. S. Henson, Vickers Ltd. Shipbuilding Group of the United Kingdom; LCDR Rod Smith and LT Paul LeGallis of the Canadian Armed Forces; Dr. Alexander Witte and J. Haas, Bruker-Physik AG Karlsruhe, Federal Republic of West Germany; Dr. Jacques Piccard, Lausanne, Switzerland; LCDR Masataka, Nozaki, Japanese Maritime Self Defense Force and Dr. Tamio Ashino, Japan Ship's Machinery Development Association.

Finally, we enter the trenches, which, in this case is manned by typists, illustrators, and photographers. My appreciation is extended to Mr. Dick Moody of the Office of the Oceanographer of the Navy, who waded through the morass of governmental contracting to somehow see all the illustrations through to timely and accurate completion. Mr. Carl Mueller, also of the Oceanographer's Office, performed all photographic reproductions and processing and still exchanges hellos after my countless changes of mind, format and requests for processing. Mrs. Becky Murray, another OCEANAV employee, had the questionable honor of typing the final drafts of this manuscript and did much to impose a degree of consistency and order to a most incorrigible subject.

The photographs which appear with NAVOCEANO (Naval Oceanographic Office) credits were taken by members of its Deep Vehicles Branch which functioned from 1966 through 1970. During this period, in which I was the nominal head of the Branch, its members contributed not only photographs, but a wide variety of practical expertise and critical observations from which I drew heavily to display my "expertise." Specifically, I am grateful to Roger Merrifield, Joe Pollio, Mike Costin, Larry Hawkins, Pete Bockman, Tim Janaitis, LeRoy Freeman and Dick Young for their years of patience and enthusiasm while I fumbled through the alleged role of "Leader."

My final thanks and gratitude are to Miss. Jean Michaud, my anchorman. Typing the first hand-written chapter as a favor, her involvement grew to providing all subsequent typing and the necessary nagging to keep the work going when the task seemed unending. Her help, encouragement and loyalty were direct contributors to its timely completion.



# TABLE OF CONTENTS

	Dedication	
	Foreword	
	Acknowledgements	
1.	INTRODUCTION	1
	Manned Submersible Defined	5
	A Field in Flux	5
	Vehicle Status	6
	Terminology and Units	7
	General and Specific Publications of Interest	8
	Soviet Bloc Submersibles	10
	The "Manned" Aspect of Submersibles	10
2.	DESIGN AND OPERATIONAL CONSIDERATIONS	13
	Environmental Constraints	14
	Vehicle Performance Requirements	16
	Human Considerations	18
	Emergency Procedures	19
	Support Requirements	19
	The <i>DEEP QUEST</i> Submersible System	20
3.	CONTEMPORARY SUBMERSIBLE DEVELOPMENT	31
	Bathysphere to Bathyscaph	32
	Pre- and Post- <i>THRESHER</i>	42
	Oceanographic Climate of the Mid-Sixties	48
	Vehicles for Any Occasion	51
	A More Conservative Approach—The 1970's	64
4.	MANNER SUBMERSIBLES: 1948-1974	75
	Dimensional/Performance Terms	76
	Component/Sub-System Terms	76
	Submersibles Described	86-240
5.	PRESSURE HULLS AND EXOSTRUCTURES	241
	Pressure Hulls	241
	Shapes	241
	Materials	247
	Fabrication	250
	Hull Penetrations	255
	External Structures	263
	Exostructures	263
	Fairings	265
	Pressure Testing	266
	Pressure Test Facilities	270
	Pressure Hull Measurements and Tests	271
	Corrosion and Its Control	275
6.	BALLASTING AND TRIM SYSTEMS	279
	Weight and Volume Estimates	279
	Compressed Air and Deballasting	282
	Ballasting Systems	285
	Trim Systems	301
7.	POWER AND ITS DISTRIBUTION	309
	Manual Power	309
	Pneumatic Power	310
	Electric Power	310

	Batteries .....	319
	Fuel Cells .....	331
	Nuclear Power .....	334
	Cable-To-Surface .....	334
	Diesel-Electric .....	336
	Power Distribution .....	338
	Penetrators .....	338
	Connectors .....	345
	Cables .....	351
	Junction Boxes .....	355
	Interference .....	361
8.	MANEUVERABILITY AND CONTROL .....	369
	Propulsion .....	371
	Maneuvering .....	381
	Motors .....	388
	Drag Forces .....	392
	Propulsion Power Requirements .....	395
	Control Devices .....	397
9.	LIFE SUPPORT AND HABITABILITY .....	409
	Life Support .....	409
	Replenishment .....	412
	Removal .....	419
	Control .....	428
	Monitoring .....	430
	Philosophical Approach .....	437
	<b>K-250</b> .....	438
	<b>BEN FRANKLIN</b> .....	438
	Habitability .....	449
	Psychological Aspects .....	463
10.	OPERATIONAL EQUIPMENT, NAVIGATION, MANIPULATORS .....	467
	Equipment .....	467
	Environmental .....	468
	Depth .....	481
	Speed .....	487
	Pitch/Roll .....	488
	Communications .....	488
	Navigation .....	494
	Surface Tracking .....	496
	Submerged Navigation .....	503
	Homing .....	512
	Manipulators .....	519
	Power .....	523
	Design/capabilities .....	525
	Claws .....	531
	Control .....	531
11.	SCIENTIFIC AND WORK EQUIPMENT .....	537
	Constraints on Submersible Instruments .....	538
	Survey Instruments .....	544
	Research Instruments .....	556
	Engineering/Inspection/Salvage .....	557
12.	SEA AND SHORE SUPPORT .....	577
	Transportation .....	577

Support Platforms .....	581
Launch/Retrieval Methods .....	592
In Use .....	596
Conceptual .....	606
Lift Hooks .....	615
Towing .....	616
Personnel and Shore Facilities .....	617
13. CERTIFICATION, CLASSIFICATION, REQUIREMENTS .....	623
Potential Hazards .....	626
System Hazards .....	626
Material and Sub-System Failures .....	626
Instrument Failures .....	627
Operator Failures .....	627
Launch/Retrieval Failures .....	628
Environmental Hazards .....	630
Natural .....	630
Man-Made .....	632
U.S. Navy Certification .....	636
Material Adequacy .....	637
Operator Competency .....	642
Operational Safety .....	644
American Bureau of Shipping Classification .....	644
U.S. Coast Guard Requirements .....	646
Search and Rescue Responsibility .....	647
MARSAP .....	647
Insurance .....	648
14. EMERGENCY DEVICES AND PROCEDURES .....	651
Emergency Avoidance Systems .....	651
Emergency Corrective Systems (Submerged) .....	659
Emergency Systems (Surfaced) .....	670
Devices to Assist Underwater Rescue .....	675
15. EMERGENCY INCIDENTS AND THE POTENTIAL FOR RESCUE .....	685
Incidents .....	686
Rescue Potential—underwater transfer .....	695
<b>DEEP SUBMERGENCE RESCUE VEHICLES</b> .....	695 & 698
Submarine Rescue Chamber .....	695 & 699
Rescue Potential—Retrieval .....	700
Ambient Divers .....	700
Manned Submersibles .....	703
Unmanned Vehicles .....	703
Time-Late .....	706
<b>PISCES III</b> Incident .....	707
APPENDICES:	
I Conversion Factors .....	713
II Submersible Vehicle Safety Act .....	724
III <b>SEA OTTER</b> Pre- and Post-Dive Checklist .....	730
GLOSSARY OF ACRONYMS AND TERMS .....	733
CORPORATE INDEX .....	738
SUBJECT INDEX .....	741
ADDENDUM .....	763







# I

## INTRODUCTION

Some four centuries before the birth of Christ, Aristotle wrote of small "diving bells" used by sponge divers who regularly worked at depths of 75 to 100 feet. The bells were inverted bowls weighted down by stones. The divers would stick their heads in them to replenish their air without surfacing. The air in the bells, in turn, was resupplied by weighted skins filled with air and lowered from the surface.

In 1620 A. D. a Dutchman, Cornelius van Drebel, is said to have constructed a submersible under contract to King James I of England. It was operated by 12 rowers, with leather sleeves waterproofing the oar-ports. Cans containing some "secret substance" (soda lime?) were opened periodically to pu-

rify the air. It is said that the craft navigated the Thames River at depths of 12 to 15 feet for several hours.

In 1707 Dr. Edmund Halley (of Halley's Comet fame) built a diving bell with a limited "lock-out" capability. It had glass ports above to light the inside of the bell, provisions for replenishing its air and crude, umbilically-supplied diving helmets which permitted divers to walk around outside—so long as they didn't lower their heads below the water level in the bell!

In the late 1770's Connecticut Yankee Dr. David Bushnell built and operated a small wooden submarine designed to attach mines to and blow up British warships. After several abortive attempts, *TURTLE*, as the ve-

hicle was named, did account for one enemy schooner.

In the early 1800's Robert Fulton (inventor of the steamship) built two iron-framed, copper-skinned submarines, *NAUTILUS* and *MUTE*. The former carried out successful military tests against moored targets for both France's Napoleon Bonaparte and the British. Neither craft was ever used operationally, however.

The first "modern" submersible—it could be argued—was Simon Lake's *ARGONAUT FIRST*, a small clumsy-looking vehicle launched shortly before 1890. Made of wooden planks and waterproofed with pitch, it was powered by a gasoline engine snorkeled to the surface through a buoy-supported flexible hose, and it boasted blowable ballast tanks—the first submarine to do so. In addition, it sported powered wheels and a bottom hatch that could be opened—after the interior was pressurized to ambient—to permit the hand recovery of bottom samples, including oysters.

These are just a few examples of the long history and the nature of man's early technological efforts to function effectively within the ocean environment. While Simon Lake in the first part of the 20th Century did develop a submersible salvage system, including submersible barges, and managed to recover a cargo of anthracite coal from the bottom of Long Island Sound, the manned submersible was not to emerge as a diverse and functional means of accomplishing useful underwater work for over half a century, which brings us to where this work commences.

In 1965 a delegation from the U.S. Naval Oceanographic Office journeyed to Lantana, Florida to evaluate John Perry's *CUBMARINE* as an undersea surveyor.

The "evaluation," to say the least, was cursory and strongly resembled a used car purchase. The team (headed by the author) gazed astutely at the tiny, yellow craft from various angles, rapped its steel hull for toughness, caressed its sides for smoothness and sat inside to see if they fit. A few hours later the team leader had the opportunity to dive in the (now pronounced) "sound" vehicle for an operational evaluation. The result was

predictable: One could see out of it, the seats were hard and there wasn't much room. But, what else could the amateur do? Had it been possible, we probably would have taken a bite out of it.

Since the mid-sixties hundreds of scientific and technical articles have appeared describing the design and materials of what are now called manned submersibles. Several books have been published that relate the activities of specific vehicles. As a result, the industrious student can—with patience and a comprehensive library—become quite familiar with the history, jargon, design and operations of submersibles and need not feel like a technological ignoramus on his first encounter.

Unfortunately, as the new student soon learns, there is no single point of reference from which to begin an education. The information is available, but it is so scattered that merely accumulating an adequate bibliography is a chore, and in the course of assembling this data, the field itself is moving at so rapid a pace that most vehicle descriptions are in error within a short time of their publication.

Adding to the consternation is the jargon; many of the terms used to describe manned submersibles, such as "trim," "blow," "vent," came directly from military submarines, but "viewports," "mechanical arms," "claws" and other terms are unique to the submersibles. Indeed "manned submersible" is not used with consistency. "Undersea Vehicles," "Deep Research Vehicles," "Deep Submergence Vehicles," "Mini-Subs," "Submersible Vessels," even "Submarinos" are synonymous. So the quest for an introduction, even a nodding acquaintance, may be detoured by jargon alone.

On the other hand there are the participants of the field; though not blocked by jargon, they have no ready access to the technological advancements or even the current progress in their own field. There is a wide variety of technical and semi-technical journals wherein bits and pieces of experience in, and advice on, submersible operations and the results of tests or evaluation of components can be found, but the time it takes to review the literature (even if it could all be found in one place) is prohibitive.

Then, there is the student of maritime history who will find excellent documentation of the early bathyscaphs and two or three accounts of the later vehicles but little at all on the techniques and design in the field at large. Reference is made later in this chapter to documentation within the field of deep submergence. It is sufficient to note that in terms of documentation the full-scale, peaceful invasion of the ocean in the last score of years was and remains almost invisible.

This is not to infer that the manned submersible is merely a historical curiosity. Documenting the ways of deep submergence benefits not only the historian but potential users and designers as well. If one is to use a present capability or improve it and at the same time avoid reinventing the wheel, it is obvious that one must know the stage to which it has advanced. In manned submersibles the "state-of-the-art" is most difficult to measure. For every question there are almost as many answers as there are submersibles. One might ask, "of what are they built?" The answer is steel, aluminum, plastic, glass and wood. "How deep can they dive?" From 150 to 36,000 feet. "How long can they stay under?" From 6 hours to 6 weeks. In short, to find the state-of-the-art, one must look at the overall field. Where one vehicle is lacking, another is not and where one cannot perform a particular task as well as another, it might very well outperform its rival in a different job. Canvassing the entire field to define each vehicle's capabilities entails a world-wide search, which few have the time or funds to pursue.

It is to help solve these problems that this book is written. It is an examination, analysis and synthesis of the last 26 years during which over 100 deep- and shallow-diving submersibles have been constructed and operated in many parts of the world. Within the past year (1973-1974) utilization and construction have literally skyrocketed following a 3-year period during which submersibles were, in fact, becoming historical curiosities.

At this point in time it would seem appropriate, therefore, to see where we've been, how well we've done and where we are.

The future of manned submersibles is not

discussed beyond a description of vehicles now under construction or about to be built. Not that the future looks dim; on the contrary, it looks fantastic. But it looked fantastic once before and then fell on its face. Predicting or even speculating on the course of future events in this area is a difficult proposition. For example, while gathering data for this book, a visit was made to Perry Submarine Builders in March 1973. At that time the Perry company had just released a good number of its employees and was retrenching owing to lack of business. The future, for Perry at least, looked rather bleak. On a subsequent visit in April 1974, the Perry workshops were a beehive of activity, and negotiations were underway to relocate and construct facilities that could handle the incredible volume of new business.

So, predictions on the future will be left to the more courageous. Also omitted is any effort to predict the application of new materials, components, instruments or power supplies. What has been and is being done in manned submersibles constitutes the primary subject matter of this work.

As one could anticipate, there are some shades of gray, and they color vehicles whose construction was started (*e.g.*, **ARGYRO-NETE**, **DEEPSTAR 20000**) but halted before completion. Such vehicles are included because they are a part of history and represent the thoughts of various deep submergence participants at that time. So, in the engineer's jargon, credentials to this book are simply that steel has been cut.

There are other benefits to be gained in looking backwards, if we look to the periphery as well; the periphery being the activities or operational methods of others and their approach to submersible diving. In this respect the subject of safety and emergency devices comes to mind. Chapter 14 relates at some length the devices and equipment carried on individual submersibles to avoid and to respond to emergencies. This listing is not presented with the inferred message that the submersible operator "must" have all of these provisions if he is to operate safely. It is given instead, as something to be considered. A requirement for distress rockets, radio homing beacons and the like may be overreacting for the submersible working in



1. Operator/observer



2. Pressure hull



3. Life support/controls



4. Exostructure



5. Ballast and trim

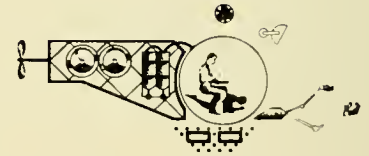

6. Propulsion/batteries



7. Fairings/sail

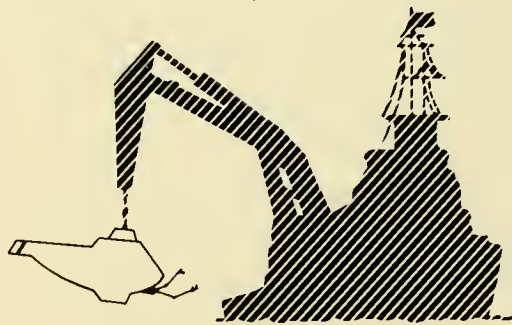

Fig. 1.1 Submersible components

a dam or Lake Geneva, but if the same vehicle moves its operations to the open sea they then warrant consideration.

Likewise, there are the different approaches to ballasting, maneuvering, life support and launch/retrieval. By reviewing the many different means to the same ends, the operator may find an idea or a different arrangement to increase the capabilities and/or performance of his vehicle.

There are, unfortunately, many stumbling blocks in trying to categorize and force order on such a free-wheeling, dynamic and widespread activity. In some cases the subject refuses to be pigeon-holed, terms must be introduced which are arbitrary, modifications to the vehicle make near-current descriptions inaccurate, and many loose ends are left. To deal with these problems, this chapter is devoted to alerting the reader to the nature of such pitfalls, omissions and inconsistencies. Other subjects will be discussed which, by their rebellious nature, are only satisfied with a separate discussion or by constant reiteration.

## Manned Submersible Defined

To limit the scope of this book the following defines a manned submersible: A manned, non-combatant craft capable of independent operation on and under the water's surface which has its own propulsion power and a means of direct viewing for the occupants who are embarked within a dry atmosphere.

This definition precludes underwater habitats which have no independent means of propulsion, swimmer delivery vehicles which are not "dry" and diver support or delivery chambers which are tethered to the surface. By definition the tethered vehicles **KUROSHIO II**, **GUPPY** and **OPSUB** should not be included, but here is another gray area. **KUROSHIO II** and its predecessor **KUROSHIO I** have been a part of submersible history since 1960; to omit them would serve no particular purpose and would deny their significant role in undersea exploration. Having made this exception, **GUPPY** and **OPSUB** must be included by default.

Throughout these pages reference is made to the "Submersible System;" this system includes not only the submersible, but a ship or surface craft to support it and an appara-

tus for putting it in and taking it out of the water. Attention is drawn to Figure 1.1 wherein the submersible system is graphically portrayed beginning with its most basic component: The human. The importance of this "system" concept is dealt with in Chapters 2 and 12.

## A Field in Flux

In a certain sense this section should be entitled "An Apology" because its message is to warn the reader that the vehicle descriptions in Chapter 4 are, to varying degrees, inaccurate. There are two primary reasons for these inaccuracies: 1) Many of the vehicles are no longer in existence and both the participants and the records often are unavailable for authenticating what data is available, and 2) the dynamics of the submersible industry. The first reason needs little else in the way of explanation, but the second requires some elaboration.

Submersibles, like any other capital equipment, can change owners, and a new owner may change not only its design, but its name as well. For example, the 1970 Perry-built **PC-9** (a Perry designation number) was originally christened **SURVEY SUB I** by its owners Brown and Root. In 1973, Taylor Diving Services acquired the vehicle and renamed it **TS-1**. Another Perry vehicle **PS-2** was built in 1972 by Perry Submarine Builders for Access of Toronto and was later christened **TUDLIK**. In about 1973 the vehicle was transferred back to Perry in Florida and reverted back to **PS-2**. In 1974 it was purchased by Sub Sea Oil Services of Milan; its name has not yet changed, but this may soon happen. Arctic Marine's **SEA OTTER** was originally **PAULO I** and belonged to Anautics Inc. of San Diego. In 1971 it was purchased by Candive of Vancouver, B.C. and subsequently leased on a long-term basis to Arctic Marine which renamed it **SEA OTTER**, while upgrading its operating depth from 600 to 1,500 feet. In some instances the same owner may retain the vehicle, but it dives under a variety of aliases. For example Cousteau's **DIVING SAUCER** is, to the French reader, **LA SOUCOUBE PLONGEANTE** (this name was also used at times in the U.S.), and in the course of its history it was occasionally called **DENICE** (after Cousteau's wife), **DS-2** and **SP-300**. In 1970 the same vehicle was

upgraded in depth from 300 to 350 meters and became *SP-350*.

Such name changes have occurred with a number of vehicles, and produce a quandary concerning which one to use and what it is now. Strictly for convenience, the names used herein are the ones with which the author is most familiar. The other aliases are given under "Remarks" in the individual listings in Chapter 4.

A change of owners generally produces a change in the vehicle. Mention was made of increasing the operating depth of *SP-350* and *SEA OTTER*. This is only one source of error in any set of "current" descriptions. The original *SURVEY SUB 1* or *TS-1* had port and starboard vertical thrusters mounted amidships, the "new" *TS-1* has shock absorbers where the vertical thrusters once were (they are now fore and aft). It also has increased life support duration, a different lift padeye, and an expanded suite of operating and surveying equipment. This is only one of many examples where the vehicle has changed by virtue of a new owner, new tasks or different operating philosophies. In regards to changing operating philosophies, the first five or six Perry vehicles used Baralyme as a carbon dioxide scrubbing chemical. Now Perry uses lithium hydroxide and has replaced the Baralyme in some other earlier vehicles with lithium hydroxide. In some cases almost the only thing remaining from the original vehicle is the pressure hull. *AUGUSTE PICCARD*, for example, is described herein as it was when first constructed. It is presently undergoing extensive modification for open-ocean surveying and except for the pressure hull and propulsion, will bear little resemblance to the original.

In other instances inaccuracies are introduced by virtue of changes occurring from the vehicle-as-constructed to the vehicle-as-operated; those changes can be substantial. The operating and design details of *DEEP QUEST* in Chapter 2 were originally obtained from a 1968 description of the vehicle. Mr. R. K. R. Worthington, *DEEP QUEST*'s Operations Manager, kindly reviewed this chapter and made numerous and critical changes to reflect *DEEP QUEST* as it now operates. Where a particular submersible has always operated for the same organization and under the same

individual, such changes have been relatively easy to identify. But, when it has changed hands or the principals involved in its operations and readiness have been replaced (as is the case with the military submersibles), it is a research project in itself to ascertain the many modifications which have taken place on merely one vehicle.

In short, the descriptions and operating details of the submersibles herein reflect them at some time in their life—though every effort has been made to be as up-to-date as possible. Dimensional characteristics, such as length, height and width, weights, operating equipment, safety devices, propulsion arrangements and other features are all subject to change which, except for those vehicles no longer operating, is probably continuous. For a first approximation the descriptions are valid, but if precise details are desired, one should contact either the current operator or operating manager. In the course of the U.S. Naval Oceanographic Office's submersible leasing program, it was quickly revealed (sometimes with chagrin) that the marketing arms of large corporations were quite often ignorant of changes to the vehicle which the operators performed.

## Vehicle Status

It would seem to be a relatively simple task to state what a vehicle's status is—*i.e.*, it is either operational or not operational. But, in reality, a vehicle's status may be quite difficult to define accurately. *ALUMINAUT* is a typical example. It is now in storage in Florida and has not dived since 1969. This does not mean, however, that it cannot or will not dive again. If a sufficiently profitable contract were to appear for *ALUMINAUT*, its owners probably would take it out of storage and put it to work. *PC-3B* or *TECHDIVER* is another example; it hasn't dived for a number of years, but again, under the right financial climate, it undoubtedly could be induced to operate. Some of the shallow vehicles, such as the *NAUTILETTE* series, only dive in the summer months when the weather on the Great Lakes is amiable; in the winter they are in storage. A few vehicles are on display in museums or parks, others have been cannibalized to a point where they are now in bits and pieces and scattered in backyards. So, in some cases

it is quite easy to place them in either the operating or non-operating category. Those vehicles not clearly in either category are classed as inactive. Specifically, the following definitions are used in this work:

**Operational:** Submersibles which have been reported diving in 1974, including vehicles which are undergoing test and evaluation and those which are undergoing modifications preparatory to diving.

**Inactive:** Submersibles which, within a 2- or 3-month period or less, can be made operational. **ALUMINAUT, GUPPY, OPSUB, TECHDIVER** are examples of this category.

**Non-Operational:** Submersibles that are incapable of operating without major refitting.

## Terminology and Units

A number of the terms herein will probably send the traditional submariner into a deep depression. With over a half century of tradition behind him, the military submariner has a ready-made field of jargon which quite appropriately applies to the military submarine. But, there is no traditional submersible and the jargon which has grown around this field comes from the aeronautical engineer, the scuba diver, the machinist, the scientist, the hobbyist and from the traditionalist himself. This variety is not surprising: With virtually all submersibles having been built and now being operated by the non-traditionalist, there is no uniformity in the terms used. This has not been a handicap to anyone in the field and is not likely to become one in the future. Indeed, as far as tradition is concerned, the operation of a manned submersible literally violates every tradition of the submarine service. Where bottoming or grounding a fleet submarine is to be avoided in all but dire emergencies, it is expected of submersibles. Where every attempt is made to keep a submarine's lines hydrodynamically clean, there is absolutely no desire or need to do so in submersibles where speed is of little importance. A "long dive" in submersibles is 12 or so hours, to the nuclear submariner this would hardly classify as a dive. Then again, launch-

ing and retrieving a fleet submarine between dives is not only unthinkable, it is virtually impossible. So while the traditionalist might blanch, most of the jargon he will find distasteful is that which is in more or less common usage. A few examples might be in order.

In some cases the term "brow" appears, this is not a typographical error, some vehicles (**DEEPSTAR 4000**) have a brow which overhangs the forward viewport; it is synonymous with bow but with a specific kind of bow.

"Trim" is the means used by a submersible to either transfer weight or rearrange displacement forward or aft to incline the submersible's bow up or down. Trim in a submarine refers to arranging ballast such that the submarine is buoyantly stable at a particular depth. Occasionally the term "pitch" is synonymous with trim in submersibles.

"Exostructure" herein refers to the structural framework external to the hull which supports the batteries, propulsion units and other components. Surrounding the exostructure may be a "fairing" which smooths out the envelope of the exostructure. Some manufacturers refer to the exostructure as the "framework" and fairings as the "skin."

The term "operator" refers to the individual who controls the movements of the submersible and it is synonymous with "pilot." Initially the term pilot was used and was quite descriptive, but in the late sixties the U.S. Navy introduced the term operator when it invoked certification for the operator(s), *i.e.*, pilots, of submersibles. As long as the term operator has remained within the military it served the purpose, but in the private sector a submersible can be and quite frequently is owned by one company, operated by another and piloted by an employee of the operating company. The dilemma, therefore, is apparent when one speaks of the operator of the submersible, is it the firm or the individual? When this confusion looms, the term pilot is used to distinguish the individual from the firm.

Many other terms are used which are generally explained within the text, but the best appreciation for the diversity from vehicle-to-vehicle can be gained by noting the different names given to components on the schematics in Chapter 4. The names given to various submersible components are those used by the owners or operators. While it might be taxo-

nomically satisfying to relabel these components with the same terms, one might find it difficult to communicate with the owner whose vehicle has been redesignated.

Finally, we arrive at units of measure or, more precisely, the metric system versus the English system. Quite evident is the fact that nothing has been done herein to advance the metric system. Recognizing the practicality of it over the English system, the conversion of the many values from the latter into the former represents a job of considerable magnitude and leads to strange dimensions. A 6-foot-diameter pressure hull would become one of 1.83 meters and still not be an exact measurement. So to simplify matters, where the original data are in meters, it is so reported, and where feet and inches are used, they are given. And, as a final apology, a table to convert the various units is included in Appendix I.

## General and Specific Publications of Interest

Throughout the text reference is made to a variety of books, articles and reports dealing with specific design aspects or operations of submersibles. For the reader who might be interested in only one vehicle or particular components of submersibles, the following books or reports, though referenced later, are noted:

### General Listings and Descriptions of Manned Submersibles

Terry, R. D. 1966 *The Deep Submersible*. Western Periodicals Co., North Hollywood, Calif., 456 pp.

Shenton, E. H. 1972 *Diving for Science*. W. W. Norton & Co., New York (describes the major components of submersibles in non-technical terms)

Penzias, W. and Goodman, M. W. 1973 *Man Beneath the Sea*. Wiley & Sons, New York (a recent listing which contains much technical information, but leans toward the technical aspects of ambient diving)

### Specific Submersible Diving History and Design

Beebe, W. 1934 *Half Mile Down*. Harcourt, Brace & Co., New York (construction and diving history of the bathysphere)

Piccard, A. 1954 *In Balloon and Bathy-*

*scaphe*. Cassell & Co. Ltd., London (**FNRS-2** and **TRIESTE 1**)

Houot, G. S. and Wilhm, P. H. 1955 **2,000 Fathoms Down**. E. P. Dutton & Co., New York (**FNRS-3**)

Cousteau, J. Y. 1956 *The Living Sea*. Harper & Row, New York (early history of **SP-350**)

Piccard, J. and Dietz, R. S. 1960 *Seven Miles Down*. G. P. Putnam's Sons, New York (**TRIESTE 1** and the events leading to its record dive)

Shenton, E. H. 1968 *Exploring the Ocean Depths*, W. W. Norton & Co., New York (Scientific diving of **SP-350**)

Piccard, J. 1971 *The Sun Beneath the Sea*. Charles Scribner's Sons, New York (**AUGUSTE PICCARD, BEN FRANKLIN**, and the Gulf Stream Drift Mission)

Link, M. C. 1973 *Windows in the Sea*. Smithsonian Institution Press (**DEEP DIVER, JOHNSON-SEA-LINK**, and other undersea activities of Mr. Edwin Link)

The Woods Hole Oceanographic Institution beginning in 1960 issued yearly reports on the design, construction, operations and modifications to **ALVIN**. The first 2 years deal with **ALUMINAUT**, which at that time was a cooperative venture between the Navy and Reynolds International, but from 1963 on through 1970 they deal only with **ALVIN**. These reports are entitled Deep Submergence Research and each covers a calendar year during the above period. Unfortunately they are not widely disseminated, but are available at WHOI and may be found in university libraries where oceanographic courses are offered. Careful reading of these is literally a course in deep submergence components and the painful progress of making a manned submersible a useful scientific tool. One of the main deficiencies with most reports describing modifications to submersibles is that the author tells what has been changed but not why it was changed or what was the problem. The WHOI reports, on the other hand, provide all such details, and they explain each change in detail: Why each change was made, what the component or system was lacking and how the new approach is intended to improve the vehicle, its support platform and its launch/retrieval system. They constitute, in substance, a technological stroll through deep submer-



gence problems and developments of the sixties.

Another series of reports, also not readily available, are the handbooks issued by the U.S. Navy's Deep Ocean Technology (DOT) Program. Recognizing the severe problems in various electrical and mechanical components in manned deep submersibles, the Navy began this program in the late sixties, and the results are profitable reading for both present and future submersible operators and designers. The various components investigated can be seen in the list below. Each handbook summarizes the problems with available components, solutions to some problems and recommendations for surmounting others. The reports are limited in distribution to those who have a legitimate need for such data, and requests should be addressed to:

Defense Documentation Center  
Cameron Station  
Alexandria, VA. 22314

As of 1974 the following handbooks have been issued which pertain to manned submersibles.

***Handbook of Electric Cable Technology for Deep Ocean Applications.*** NSRDL (A), 6-54/70, Nov. 1970. AD 877-774.

***Rotary Shaft-Seal Selection Handbook for Pressure Equalized, Deep Ocean Equipment.*** NSRDC(A), 7-753, Oct. 1971. AD 889-330(L).

***Handbook of Vehicle Electric Penetrators, Connectors and Harnesses for Deep Ocean Applications.*** NAVSEC, July 1971. AD 888-281.

***Handbook of Fluids and Lubricants for Deep Ocean Applications.*** NSRDC(A) MAT-LAB 360, Rev. 1972. AD 893-990.

***Handbook of Fluid Filled, Depth/Pressure Compensating Systems for Deep Ocean Applications.*** NSRDV(A) 27-8, April 1972. AD 894-795.

***Handbook of Electrical and Electronic Circuit-Interrupting and Protective Devices for Deep Ocean Applications.*** NSRDC(A), 6-67, Nov. 1971. AD 889-829.

***Handbook of Underwater Imaging System Design.*** NUC TP 303, July 1972. AD 904-472(L).

#### Submersible Work and Instruments

Excluding the DOT handbooks, all of the publications listed above contain accounts of

various work performed by the particular submersibles. Additionally, the references in Chapter 11 relate specific work accomplishments by a variety of submersibles. Noteworthy, is reference (1) of Chapter 11, which summarized all of the published scientific accounts of submersible work through 1970. A popularized version of submersibles and their accomplishments is contained in:

Soule, G. 1968 *Undersea Frontiers*.

Rand McNally & Company, New York

The references in Chapter 11 also describe, to varying degrees, the instruments used to perform certain tasks. The best single reference for work tools is Winget's report (ref. 6, Chap. 11) which not only describes a wide array of work tools, but also provides the manufacturer's name and address for each component used in each device described. This report can only be described as a goldmine for the builder or designer of submersible work equipment.

Since the seventies most of the literature describing submersible work is relatively sparse. Perhaps because the work is no longer mainly scientific and may be considered proprietary information by the user. Virtually all recent accounts merely describe the job as pipeline inspection, cable burial, or the like, with details of the why, how and performance of the vehicle and tools omitted. Likewise, are accounts of submersible scientific endeavors sparse regarding performance of vehicles and instruments. Reports of the National Oceanic and Atmospheric Administration's Manned Undersea Science and Technology Program relate what work was done, why and, when possible, its scientific implications, but nothing regarding the performance, problems or solutions is included. Such omissions, though clearly a prerogative of the user, are unfortunate, because identifying and making known the problem areas of submersibles is the only means of providing direction or goals to the designer of future vehicles.

#### Soviet Bloc Submersibles

Conspicuous by its absence is any discussion of Soviet Bloc submersible design. The reason is quite simple: There is no easy way

to authenticate what information is available. Mr. Lee Boylan of Informatics Inc., Rockville, Maryland summarized Soviet-bloc submersible development in a 1969 monograph for the Marine Technology Society Journal (v. 3, n. 2) and updated this report in 1972 in the same Journal (v. 6, n. 5). Mr. Boylan's original work was based on 206 articles and reports from the Soviet Union and elsewhere. It is most comprehensive, but Boylan himself admits that his 45-year history does not comprise the entire Soviet Bloc inventory. There are a few other articles which serve to reinforce Boylan's tabulation, but the picture is still confusing.

From those details that are available, Soviet submersible development and use have been primarily aimed at fisheries investigations. In 1957 the Soviets converted a fleet-type submarine into the fisheries research vehicle *SEVERYANKA*. Seven research cruises were conducted by this vehicle during the next few years. Then it appears to have been decommissioned in the early sixties.

At present, Russia, according to Boylan, has or has had four submersibles which followed *SEVERYANKA*; these are: The 6,562-ft *SEVER 2*, the 810-ft *GVIDON*, the 984-ft *TINRO 1*, and the *DOREA* for which no operating depth is stated. International Hydrodynamics of Canada is constructing a *PISCES*-class submersible (6,500-ft depth) and the lock-out vehicle *ARIES* (1,200-ft depth) for the Soviet Union for delivery sometime in 1974.

Admittedly, this is making very short shrift of Soviet Bloc undersea efforts. Although they seem quite active in habitats and swimmer delivery (wet) vehicles, there is little information available on the actual submersible field. A report by V. S. Yastrebov, Head of the Laboratory of Underwater Research Technique, Academy of Sciences, USSR, tends to confirm that there is really very little to report in Soviet submersible activities. Yastrebov's report (presented at the Brighton Oceanology International Conference, 1972) compares the efficiency of divers and underwater devices. He speaks of an unmanned Soviet bottom crawler, *CRAB*, and of manipulator experiments at the Academy of Sciences, but every example of sub-

mersible performance he cites is of a U.S. vehicle. Furthermore, of 14 references in Yastrebov's report, 11 are from U.S. sources. In another paper given at the Brighton Conference, V. G. Azhazha of the Central Research Institute of Fisheries Information and Economics analyzed the efficiency of submersibles in fishery investigations. Here again, except for a brief mention of *SEVERYANKA*, all of the submersibles mentioned are U.S., English or Canadian. One is left to conclude, therefore, that Soviet-bloc at-sea submersible experience is quite limited, of a confidential nature, or both.

### The "Manned" Aspect of Submersibles

The most significant omission of submersible components in the following chapters is the human component. The Deep Submersible Pilots Association and the Navy's Submarine Development Group One have defined the minimal requirements for an operator or pilot. Chapter 12, herein, tabulates the number and types of operating and support personnel for selected vehicles. Unfortunately, all of these fall quite short in actually defining the nature and qualities of the people who keep the system running efficiently and safely. Indeed, if one were to list the desirable attributes of a submersible crewman—and the crew includes support as well as operating personnel—the final product would seem unattainable.

First, for the most part submersibles work far out at sea or in other isolated places where public admiration is not the rule. Secondly, photographers, press agents and media representatives are generally unaware of submersible activities until there is an emergency, and these are quite rare. Thirdly, working at sea is arduous, frustrating, continuous and, in the submersible business, calls for the skills of a seaman, an engineer, a diver and a master mariner. The point is that the personnel must be highly-skilled, dedicated individuals who are willing to spend a good portion of their life on a pitching, rolling, benevolent prison. The pay is not fantastic and residuals for television advertisements are unknown. One hundred percent successful missions are rare, and frustrating compromise is generally the rule.

So one might ask, where do you find such people and what do you offer? Quite frankly (and somewhat mysteriously), they find you and surmounting the challenge seems to be reward in itself. Commonality of backgrounds, such as education, technical training and the like, is not readily apparent. Most however, have spent a major portion of their adult life working with the sea, either in the Navy or with commercial enterprises. Many, through various channels, simply drift into the submersible area, others specifically seek out the field. In either case, all have a capacity for hard work and seem to possess an unusually wide-ranging knowledge of seamanship, diving, electronics and other skills related to submersibles. Admittedly it would be quite helpful to state the desirable background characteristics to look for in a submersible operator and the support crew, but, in the author's experience, all are quite individualistic and, like submersibles themselves, defy categorization. Yet each seems to have a particular skill that contributes to a successful operation.

In this respect, an incident comes to mind of a lost current meter array retrieved by *ALUMINAUT* in 1967 off St. Croix, Virgin Islands. *ALUMINAUT*, at that time, was the ultimate in deep submergence technology, it represented the best efforts of the best scientific and engineering expertise industry and academia could offer. In the course of re-

trieval it dived, made the necessary hookup and performed perfectly. The final step, however, was to reel the retrieving line onto the support ship. To complicate matters, when the array line began appearing at the surface it was a snarled and tangled mass of nylon rope, wire and current meters. At this point the knot-tying and load-handling talents of an ex-navy bosun, Mr. Doug Farrow, were required for several hours to successfully bring the spaghetti-like mess aboard.

The "manned" component, therefore, requires skills which range from those traceable to the Phoenicians to those developed in the space age. Man's ancestors, it is said, left the ocean in primordial times; since recorded history it is evident that he has tried, with some success, to return. In earlier days it was in wood and leather diving bells and suits; now it is in steel and plastic shells. Whatever the means, it has always been man; never machines, against the sea. The instruments, be they submersibles, submarines, towed devices or whatever, are inanimate, inert and functionless without the intervention of a human being. Regardless of its duration, if the return to the sea is to be successful, an arsenal of human talents must be drawn from the pages of ancient and recent history. The knot tier, the navigator, the mariner, the engineer and the theoretical scientist all share equal responsibilities and all can be found somewhere in the successful submersible system.





# 2

## DESIGN AND OPERATIONAL CONSIDERATIONS

To accomplish its passenger-carrying and work functions economically, a submersible must be transportable, easily maintainable, and amenable to launch/retrieval from a rolling vessel. A review of the submersibles in Chapter 4 reveals the varied approaches to these requirements. No matter what the approach, there are laws of physics and human biology which all successful vehicles must obey. There are also logistical and operational considerations which, because of their importance, are an integral part of the submersible diving system; these are its support platform, and its launch/retrieval apparatus.

Five categories have been defined and include the design and operational factors with

which the successful submersible operator must contend; these categories are:

- Environmental Constraints
- Vehicle Performance
- Human Considerations
- Emergency Procedures
- Support Requirements

The factors within these categories are drawn from the history of submersible operations and deal with the submersible system instead of the submersible as an independent operator. Inclusion of support requirements may seem outside the scope of submersible diving principles; but submersibles are not military submarines, and none routinely operates in the open sea without surface support and, in the final analysis, shore support.

# ENVIRONMENTAL CONSTRAINTS

## Pressure

A fundamental consideration in the design of any vehicle transporting man or equipment underwater is pressure. Pressure may be resisted, as it is by the submersible's pressure hull, or it may be compensated, as is the case with many battery packs, propulsion motors, etc. Once the submersible's operating depth has been established, the pressure at that depth will determine the dimensional and compositional characteristics of the vehicle and its components.

Pressure in the ocean is a function of depth, and for routine oceanographic calculations the 33-foot depth is equal to about 1 atmosphere (14.7 psi). To moderate depths, say to several thousand feet, seawater may be considered incompressible and the following expression is used:

$$p = p_a + wh$$

where  $p$  is pressure in pounds per square inch (psi),  $p_a$  is atmospheric pressure (psi),  $w$  is a 1.0-ft head of standard salt water equal to a pressure of 0.4447 psi and  $h$  is depth in feet; then

$$p = 14.7 + 0.444h \text{ psi}$$

At greater depths, the compressibility of water must be considered and, to obtain a more accurate value, the density of seawater may be taken as varying linearly from 64 pcf at the surface to 66.6 pcf at 30,000 feet (Fig. 2.1). Neglecting atmospheric pressure, the pressure at depth  $h$  then is approximately

$$p = 0.444h + 0.3\left(\frac{h}{1,000}\right)^2 \text{ psi (ref. 1)}$$

Hence, at 6,000 feet, the pressure on the surface of a body is 2,674.8 psi acting normal to every exposed surface.

## Seawater Conductivity

Various devices in submersibles, *e.g.*, motors, batteries, pumps, are immersed in a protective liquid which serves as an ambient pressure compensator and an insulator against loss of power to seawater. The intrinsic dielectric conductivity of seawater is approximately 4 mhos/m (milliohms/meter) or 4,000 times greater than that of fresh water;

and, it increases with temperature, salinity, frequency of the propagating wave and pressure (1). A common cause of failure in electrical systems is contamination of the compensating/insulating fluid by seawater, where as little as 0.1 percent contamination reduces the resistivity of some fluids below recommended limits (3). Various forms of corrosion (pit, crevice, stress, layer, etc.) attack metals in seawater. Protective coatings and/or sacrificial anodes should be considered in the initial design stage.

## Temperature

The temperature of seawater (Fig. 2.1) has, among others, two important effects on submersible diving: 1) The occupants must deal with extremes of temperature caused mainly by loss or gain of heat through the pressure hull; and 2) the pressure hull material must be capable of retaining its desirable characteristics (crack arrest) under cold temperatures encountered above and below the surface.

## Light

Sunlight has been observed to penetrate the ocean to depths as great as 2,300 feet (4), but usable sunlight for detailed external viewing generally terminates at 1,000 feet even under the very best of conditions. Consequently, the submersible user must rely on artificial light sources for external illumination. Because of the lateral and vertical variability of light transmission properties and the frequent blinding effects of backscatter throughout the oceans, lighting for each diving mission is approached on a case-by-case basis.

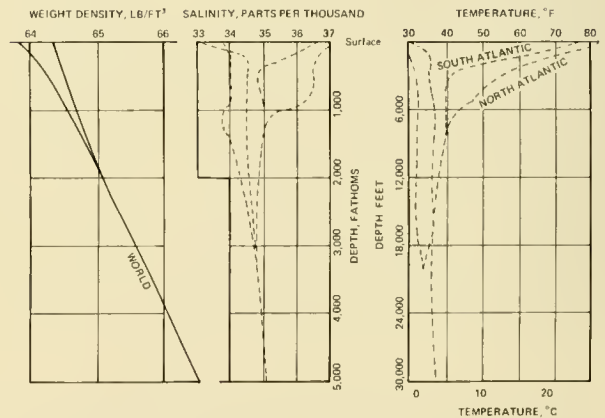

Fig. 2.1 Seawater density, salinity, and temperature as function of ocean depth. [From Ref. (2)]

## Currents

Currents in the ocean and contiguous waters range in horizontal speeds from less than 0.05 knot (Pacific deep water) to 15.5 knots (Skjerstadt Fjord, Norway), and they fluctuate rapidly both spatially and temporally (5). Where currents are strong, the submersible must be able to maintain control and headway to conduct its task and maneuver safely.

## Density

Since seawater density varies not only with depth (Fig. 2.1), but with temperature and salinity as well, vehicle buoyancy calculations must be based on the specific diving location. In some instances, underwater discharge of fresh or brackish water near the bottom has caused significant loss of positive buoyancy on a submersible working close to the bottom (6).

## Acoustics

Light and radio waves attenuate rapidly in the ocean. Depending on the frequency of the signal and oceanographic conditions, sound waves may travel for thousands of miles. Sound, therefore, is used for communications between ship and submersible, for tracking of the submersible from the surface and for a variety of data collection instruments. The velocity of sound in seawater varies from about 4,775 to 5,150 feet/second and increases with increasing temperature, salinity and pressure (5). If sound is traveling vertically downward, the effect of refraction (bending) is relatively slight; as the beam direction approaches the horizontal, refraction may become quite great. The usual situation (Fig. 2.2) is for sound speed to decrease initially with depth as the temperature decreases; hence, the upper part of the sound beam travels faster than the lower part and a shadow zone, into which the sound beam does not penetrate, is left near the surface. Such refraction may occur at any depth in the ocean; its effects can control the ranges from which a submersible can be tracked from its surface support and still maintain voice contact.

## Sea State

The operational limits of submersibles' launch/retrieval devices are determined by wave height (the vertical distance from wave trough to crest) and period (the time interval

between successive crests passing a stationary point); the condition is generally termed Sea State, and its boundaries are presented in Table 2.1. Sea state, as defined in the accompanying table, is misleading as a measure of the ability of a launch/retrieval apparatus, for it does not take into account wave period. For example, launch/retrieval may be ruled out in low sea states if the period is on the order of 8 to 10 seconds; but, if the period is doubled or greater, the frequency of the wave crest's passage is less and time may be sufficient to complete the hook-up of lift lines between successive crests. One must be aware that the sea surface is rarely calm and is in a constant state of change. If a submersible system is to

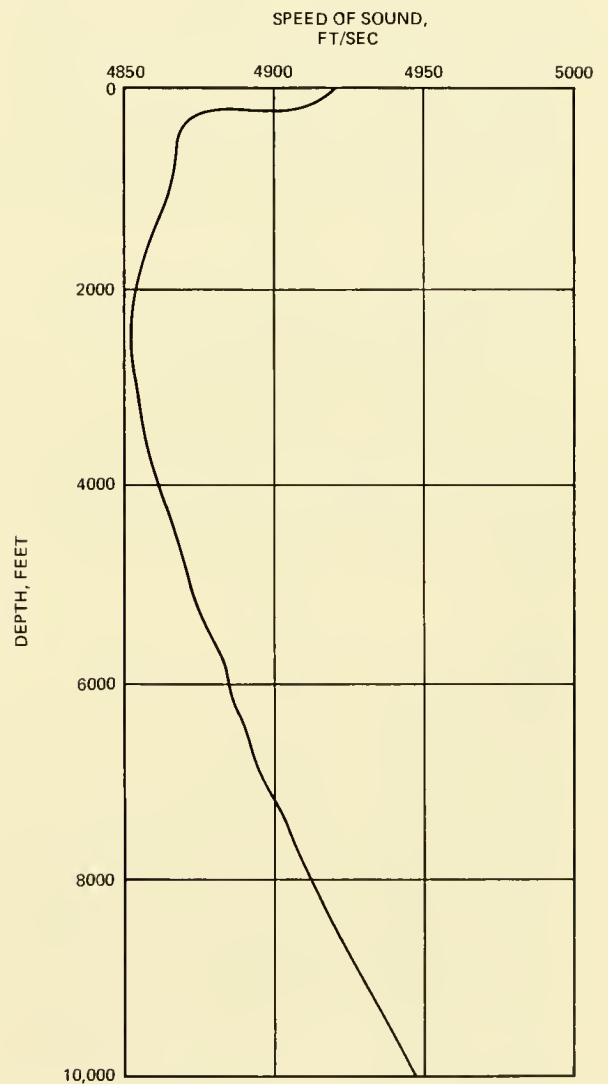

Fig. 2.2 Typical variation of speed of sound with depth in the ocean.

be economically practicable, the ability to deploy and recover the vehicle safely under average weather conditions is just as important as pressure hull integrity.

### **Bottom Conditions**

The ocean floor ranges in composition from soft, fine muds to hard rock cliffs; a submersible can be expected to operate within these ranges. During operations requiring a vehicle to transit near the bottom, search missions for example, the pilot generally prefers to "fly" just off the bottom, a few pounds negatively buoyant. This procedure makes vertical control of the submersible much easier. Over a rough, hard bottom, rugged skegs or other devices (wheels, skids) are used to protect the pressure hull and other components. On a soft bottom the submersible may accumulate sediment, the weight of which can become great enough to restrain the vehicle from surfacing. *ALUMINAUT*, for example, accumulated approximately 4,000 pounds of sediment in this manner during an operation off the coast of Spain.

## **VEHICLE PERFORMANCE REQUIREMENTS**

No one submersible is designed to perform all the underwater tasks that may arise, but there is a commonality of vehicle performance requirements which may be found by analyzing past dives; these requirements are listed below.

### **Viewing**

Some means for external viewing is required. Viewports (windows) provide the easiest and most reliable solution, but their location and quantity are arbitrary and frequently dictated by other characteristics of the hull configuration. Acrylic plastic pressure hulls are available which can provide panoramic viewing. Television cameras are an adjunct to direct viewing and, with low light level amplification, may provide greater range and resolution. Optical viewing systems, *e.g.*, periscope-type, have also been employed.

### **Buoyancy**

Archimedes' principle defines the magni-

tude of upward buoyant force: *any object immersed in a fluid is buoyed up by a force equal to the weight of the fluid displaced.* Three states of submersible buoyancy are desired: Positive, negative and neutral. Displacement volume (D) determines the buoyant force, and buoyancy is expressed by the ratio  $W/D$ , *i.e.*, weight of vehicle (W) to weight of displaced water. Buoyancy regulation under different vehicle load and water density conditions requires variable ballast systems which may include one or more of the following: Water ballast tanks, steel shot, gasoline filled tanks, or interconnected hard and soft containers.

### **Trim**

To correct unequal weight distribution along the longitudinal axis which might cause the vehicle to have an up or down angle from the horizontal, or to intentionally obtain such an up or down angle for the dive mission, a trim system is required. This system, through a variety of methods, acts to transfer weight or ballast forward or aft.

### **Stability**

Stability is that property of a body that causes it, when disturbed from a condition of equilibrium, to develop forces that tend to restore it to its original condition. Equilibrium is a state of balance between opposing forces which may exist in three states: Stable, neutral, and unstable. For example, if when an angle is put on a ship forces are set up which act to reduce the angle, the ship is stable. Neutral equilibrium exists when a body remains in its displaced position after a force that displaced it is removed; unstable equilibrium exists when a body continues movement after a slight displacement. Stability in a submersible is intimately related to center of buoyancy and center of gravity. The center of buoyancy is the geometric center of volume of the displaced water. The center of gravity is the effective center of mass. These two centers are indicated as B and G, respectively, in Figure 2.3a. When a floating body is in stable equilibrium, its center of buoyancy and center of gravity are in the same vertical line. Another term which must be introduced to understand stability is metacenter, which is the point of intersec-



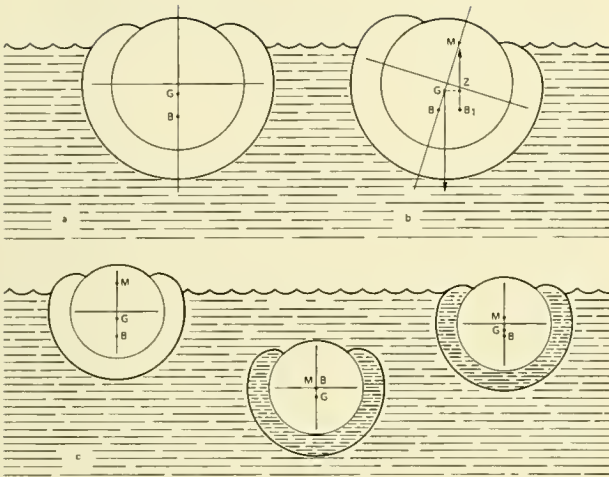

Fig 2.3 Change of center of buoyancy metacenter during submergence.

tion of a vertical line through the center of buoyancy of a body floating upright and a vertical line through the new center of buoyancy when it is inclined a small amount as indicated by the letter M in Figure 2.3b.

When a surfaced submersible is tipped as shown in Figure 2.3b, the center of buoyancy moves from B to B1 because the volume of displaced water at the left of G has been decreased while the volume of displaced water to the right is increased. The center of buoyancy, being at the center of gravity of the displaced water, moves to point B1 and a vertical line through this point passes G and intersects the original vertical at M. The distance GM is known as the metacentric height. This illustrates a fundamental law of stability. When M is above G, the metacentric height is positive and the vessel is stable because a moment arm, GZ, has been set up which tends to return the vessel to its original position. It is obvious that if M is located below G, the moment arm would tend to increase the inclination. In this case, the metacentric height is negative and the vessel is unstable.

When on the surface, a submarine presents much the same problem in stability as a surface ship. However, differences are apparent as may be seen in the diagrams in Figure 2.3c, where the three points B, G, and M, though in the same relative positions, are much closer together than is the case with surface ships.

As noted above, when a ship on the surface heels over, there is a shift in the position of the buoyancy center because of the volume shape change below the waterline. In the case of a submerged submarine, no such change takes place because all the volume of the submarine is below the surface of the water. Thus, for submerged stability, the center of gravity must be below the center of buoyancy.

During the process of going from the surfaced condition to the submerged condition, the center of gravity of the submarine, G, remains fixed slightly below the centerline of the boat while B and M approach each other. At complete submergence, G is below B, and M and B are at a common point. These changes are shown diagrammatically in Figure 2.3c.

As the ballast tanks fill, the displacement becomes less with the consequent rising of B and lowering of M. There is a point during submergence when B coincides with G. Due to the configuration of the upper part of the hull, B would only move a short distance from G if a list were taken at this point. In this condition, the stability is least; and the time spent at this low-righting stage must be minimal. When the ballast tanks are fully flooded, B rises to the normal center of buoyancy of the pressure hull, and stability is attained with G below B.

To keep the center of gravity low, batteries and other heavy items are carried as low as possible where they have the greatest effects on stability. Submersible transverse metacentric heights (submerged) are quite small and range from 3 to 12 inches.

## Power

Electric power is compatible with all propulsion, lighting, hotel, and virtually all instrument requirements and is the exclusive ultimate power source in all deep submersibles. Long duration power can be supplied from the surface through a cable, but at the expense of maneuverability; conversely, maneuverability is retained using self-contained batteries, with a corresponding limitation in operating time. Two power options predominate in shallow (less than 1,000-ft) submersibles: Manual and electric. Transfer of manual power through the pressure hull

can be by direct mechanical linkage (limited to shallow depths owing to compression on the hull with consequent size reduction of thru-hull penetrations) or by hydraulics.

### **Maneuverability**

The requirements for maneuverability vary considerably in speed and degree, but generally the vehicle is expected to be capable of controlled movement in the vertical and horizontal. For many if not all missions, the vehicle must be able to "hover" (dynamically or statically) at a given depth or distance above the bottom.

### **External Attachments**

For maximum mission adaptability, the vehicle should have external attachment points for installation of various instruments or devices to conduct undersea tasks. Since few, if any, of these instruments are standard in weight, size, shape, or mode of operation, a degree of flexibility in such attachment points is desirable. In the probable event that such devices will require electrical power and/or control, provisions must be made to furnish spare electrical connectors and thru-hull penetrators.

### **Lock-out/Lock-in**

If the submersible is designed for transporting and supporting divers, provisions must be made for ballasting the vehicle when they leave (to restrain it from ascending) and deballasting when they return. Hatches and viewports in the diver's compartment must be double-acting to resist not only external pressures, but internal pressures as well. Communications must be arranged between the diving compartment and the unpressurized part of the pressure hull; and, when surfaced, a means of providing food or medical aid must be incorporated in the design if decompression is required. Whereas the egress/ingress hatch will be on the keel of the submersible, and the vehicle might be bottomed during diver operations, space between the hatch and bottom must be sufficient to allow easy access to the hatch. Consideration must likewise be given to personnel transfer to a decompression chamber.

### **Weight and Size**

The submersible's dry-weight (in air) and

physical dimensions will govern the methods of launch and retrieval as well as the size of its support ship and the methods available to it for land and air transport.

### **Payload**

There are no minimum or maximum payload standards, and they range from less than 100 pounds to several tons. The larger the payload requirements, the larger the vehicle size and, correspondingly, the greater the necessary support efforts become, with resultant lowered mobility. Trade-offs are possible whereby a non-essential manipulator, for example, might be replaced with another instrument or a lock-out chamber replaced with a different module for a particular dive. Distribution of payload weight and balance must be considered to assure that vehicle trim and control are not jeopardized.

## **HUMAN CONSIDERATIONS**

### **Respiration**

Oxygen must be supplied, and carbon dioxide must be removed for the duration (6-12 hr) of a normal dive and for an extended period in the event of an emergency. Monitoring devices must be included to maintain proper levels and to check for the presence of contaminants. In the event of diver support, storage and supply of air or mixed gas (*e.g.*, helium/oxygen) must be accommodated.

### **Temperature/Humidity**

In shallow tropical dives, temperatures (°F) and relative humidity (%) reach into the 90's; with depth, or in the high latitudes, the temperature can fall into the 40's with a corresponding humidity decrease. Both these extremes bear heavily on human performance and must be dealt with successfully. Deep diving in the tropics can combine both extremes and includes condensation on the interior walls of the hull with consequent drippage; this can be detrimental to equipment as well as to human occupants.

### **Food/Water**

Normal and emergency food and water rations must be carried; limited power or the possibility of its entire loss restricts the type of food and preparation possible.

## **Waste Management**

Means must be provided to accommodate metabolic wastes and to treat and store such wastes for the duration of the dive.

## **Fatigue**

The internal arrangements for pilot and passenger(s) must be such that the efficiency of both is not decreased by uncomfortable or awkward layout of instruments and controls. Similarly, long periods at the viewports can be extremely taxing and detrimental to the mission if pilot or observer is forced into awkward positions to view or work.

# **EMERGENCY PROCEDURES**

## **Entanglement**

To minimize the fouling potential with foreign objects such as wreckage, cables, or ropes, submersibles should have smooth, streamlined exterior surfaces and objects extending beyond the fairing should be kept to a minimum. When possible, objects that offer a potential for fouling should be jettisonable.

## **Power Loss**

In the event of a complete electrical power loss, the vehicle should have mechanical means of surfacing either by jettisoning components, dropping extra ballast or blowing water ballast. An emergency power supply to operate critical emergency components should be considered.

## **Fire and Noxious Gasses**

Emergency breathing apparatus and fire extinguishers within the pressure hull are required in the event of fire and release of noxious or toxic gasses. Nonflammable wiring insulation should be used for all power cables and control wiring. Only insulation, paint, plastics, and other materials free of detrimental outgassing should be used inside manned spaces.

## **Deballasting Loss**

A number of vehicles contain backup deballasting procedures in the event that the normal deballasting does not function or is insufficient. These include jettisoning of batteries, instruments, manipulators, or trim liquids (mercury). Where depth allows, many

vehicles may be flooded by ambient seawater or pressurized by compressed air to open the hatch for emergency exit. In a few cases, the entire positively buoyant pressure hull can be manually released from the remainder of the vehicle, whence it will freefloat to the surface.

## **Tracking Loss**

Owing to inaccuracies in tracking procedures or accidental loss of acoustic contact, a submersible may surface out of contact with its support ship and be completely on its own. Emergency signaling devices and radios are required. Some vehicles have such low freeboard that to open the hatch in anything higher than sea state 1 could swamp the pressure hull. In this case, emergency flares might be impossible to employ, and if a long period of time must be spent with the hatch closed awaiting outside assistance, the endurance of the emergency life support system to sustain the passengers could be exceeded. The color of the submersible might also be critical to visual sighting. A white submersible, with only 1 or 2 feet of its conning tower or sail protruding above the surface and posed against a background of whitecaps, is extremely difficult to see. Furthermore, radar may be ineffective owing to the sail being masked by sea return.

# **SUPPORT REQUIREMENTS**

## **Transportation**

Weight and size are the factors controlling a submersible's transport and, hence, mobility. Land, sea and air transportation are possible; but, for some vehicles, this means dismantling major components. Deployment at the site of embarkation requires lift and possible rail facilities not available at many ports.

## **Support Platform**

There are few, if any, occasions when a submersible will not require a support platform. At the very least, this platform will be required to tow the vehicle to the dive site and track it while submerged. In open-sea operations, the platform will act to maintain the vehicle, house its support and scientific crew, and perform work tasks in conjunction

with the submersible. Proper selection of such a platform is critical to the effectiveness of the submersible system.

### Launch/Retrieval Apparatus

Unless the submersible is too large for launch/retrieval at sea, an apparatus is required to deploy and retrieve it after each dive. Four basic methods may be utilized. One is a device to attach to and lift the vehicle out of the water, such as a crane. The second involves deballasting a submersible platform onto which the submersible is maneuvered. Third is the mechanical hoisting of an elevator platform attached to a surface vessel. A fourth approach involves the mother submarine concept in which the submersible is launched or retrieved and transported by a completely submerged platform. In the event of external repairs or maintenance to the submersible, the mother submarine may be required to surface.

### Tracking and Navigation

While the submersible is submerged, a method of tracking from the support platform is required to locate it, to clear the area for surfacing, and to join with the vehicle after the dive. If the mission requires knowing precisely where the submersible was, such as surveying, a method of geodetic positioning is necessary. This might be served through the tracking system if the support platform maintains a running log of its own and the submersible's relative position, or it may be an *in situ* navigation network by which the vehicle itself maintains a real-time display and record of its underwater position.

## THE DEEP QUEST SUBMERSIBLE SYSTEM

To demonstrate one manufacturer's approach to meeting the constraints and re-



Fig. 2.4 a) The submersible system DEEP QUEST (LMSC); b) Schematic of DEEP QUEST as designed with potential diver lockout compartment and transfer bell. (LMSC)

quirements of submersible diving, Lockheed Missiles and Space Corporation's **DEEP QUEST** system will be examined (Fig. 2.4a). **DEEP QUEST** is not necessarily the most successful approach, but its 8,000-ft operational depth capability and support systems confront and offer solutions to the majority of problems encountered. (The following data was attained from refs. 7 through 11.)

## ENVIRONMENTAL CONSTRAINTS

### Pressure

The manned compartment (pressure hull of **DEEP QUEST**) consists of two intersecting spheres welded together with a 20-inch-diameter opening between the two and a 20-inch-diameter opening (hatch) atop the aft sphere. The spheres are 7 feet in outside diameter (OD), 0.895 inch thick, and are composed of 18 percent nickel, 200-KSI-grade

maraging steel. A weldment of four hemi-heads and interconnecting "Y" rings form the basic structure. A collapse depth of 13,000 feet (5,772 psi) provides a safety factor of 1.6 at its operating depth of 8,000 feet (3,554 psi). **DEEP QUEST** has been designed to incorporate a diver lock-out compartment and a transfer bell as shown in Figure 2.4b, but these are not affixed to the submersible at present.

### Seawater (Corrosion Protection)

To protect the fairings and foundations, piping, variable ballast tanks, high pressure air tanks, and electrical inverter/controllers, a multi-coat polyurethane Laminar X-500 finish has been applied. The pressure hull is isolated from contact with the aluminum outer hull by mounting it on rubber pads and clamping it down with a phenolic collar. It is further protected by a mild steel anode system. Whenever possible, dissimilar metals are electrically isolated by non-conductive

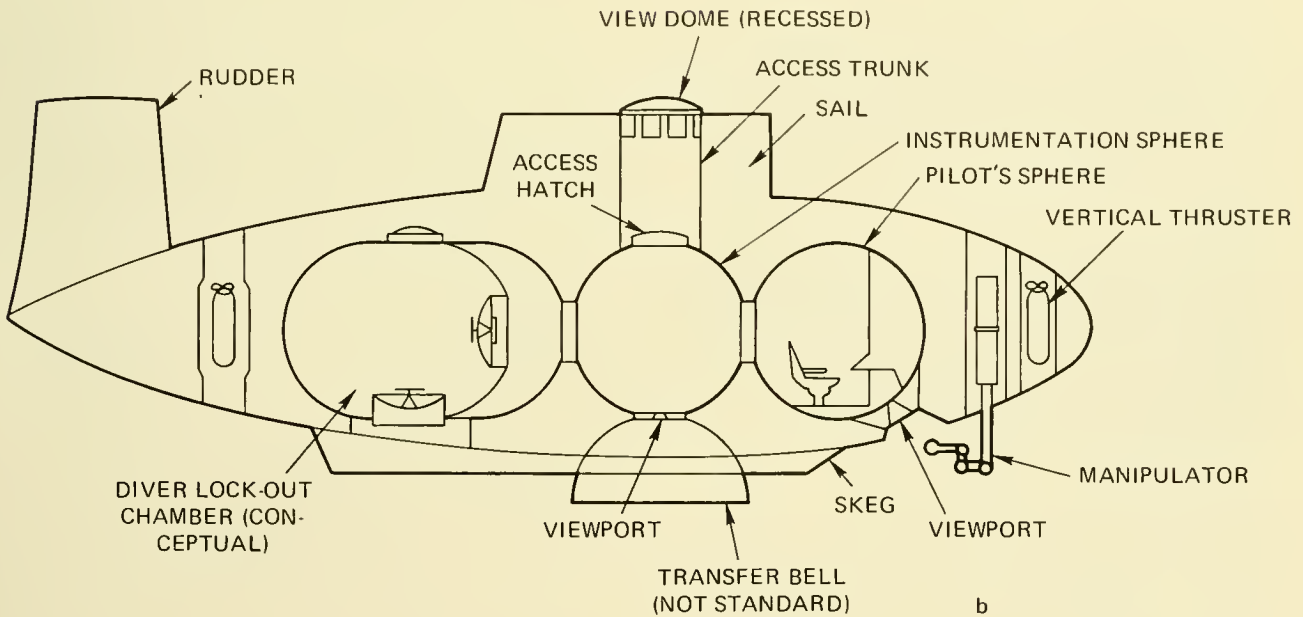

Fig. 2.4 b) Schematic of DEEP QUEST as designed with potential diver lock-out compartment and transfer bell. (LMSC)

mountings. Small zone anodes are utilized freely to protect against electrolysis.

### Temperature

To control the pressure hull's internal temperature there are two temperature sensors in each of the two spheres which activate an electrical damping system to apportion air through three heat exchangers. Excess heat (from personnel and operation of electrical equipment) is conducted through the hull wall. Electrically powered heater strips supply additional heat if that produced by equipment operation is insufficient. Toughness (crack arrest) of the pressure hull's maraging steel was improved by careful modification of the chemical composition of the steel.

### Light

To provide external lighting at depth, *DEEP QUEST* has nine fixed lights ranging in power from 500 to 2,500 watts; these may be individually controlled. On each of the two television pan and tilt mechanisms is a 500-watt flood light for trainable illumination.

### Currents

To counter adverse currents, in addition to maneuvering, *DEEP QUEST* may employ two 7.5-hp, stern-mounted axial thrusters and one 7.5-hp lateral water-jet bow thruster.

### Density

A steel shot (1,900 lb dry weight) releasable ballast system is used to adjust for minor seawater density changes. *DEEP QUEST* normally operates submerged in a slightly heavy (negative buoyancy) condition, taking advantage of her lifting body outer hull configuration and vertical thrusters.

### Acoustics

To minimize the effects of sound refraction, the submersible's support ship *TRANSQUEST* attempts to maintain a position nearly above *DEEP QUEST* during the dive. Two 27-kHz acoustic pingers are affixed to the submersible; one is omnidirectional and one is vertically oriented by a parabolic reflector. A directional hydrophone antenna on *TRANSQUEST* provides the relative bearing to *DEEP QUEST* and a modification to the submersible's underwater telephone (UQC)

provides range information on a digital read-out.

### Sea State

*TRANSQUEST*'s launch/retrieval system (see Chap. 12), a hydraulically-powered elevator platform mounted in the open-sternwell, is marginally effective at sea state 4 in short period waves, optimizing at longer period swells.

### Bottom Conditions

*DEEP QUEST*'s outer hull is streamlined and rugged. Two skids on the bottom of the vehicle protect it against damage and hold it high enough off the bottom to inhibit the possibility of accidentally taking aboard sediment. Object avoidance/search sonar provides for full-scale range indications from 15 to 1,500 yards.

## VEHICLE PERFORMANCE

### Viewing

For direct viewing, *DEEP QUEST* incorporates two viewports; one in the forward hull looks down and forward; one in the aft hull looks directly down through a hatch located on the bottom of the aft hull. The aft viewport is equipped with an optical remote viewing system incorporating an external "fish-eye" lens. Augmenting the viewports are two (port/starboard) pan- and tilt-mounted TV cameras; one bow-mounted TV camera, and one sail-mounted, 360-degree-vision, periscope-scanning, TV camera, and a fifth camera mounted as desired to observe a particular area or equipment for the specific dive.

### Buoyancy

Four ballasting/buoyancy components are incorporated in *DEEP QUEST* (Fig. 2.5): 1) A Main Ballast System, consisting of two forward and two after tanks (port/starboard), provides 12 percent reserve buoyancy on the surface and is blown free of water by compressed air; 2) a Shot Ballast System, consisting of 1,900 pounds (wet) of steel shot in two cylindrical hoppers mounted outboard in the longitudinal C.G. plane provides "fail safe" ballast which is electromagnetically held and dropped in the event of a total power loss or metered out as desired; 3)

34,000 pounds of syntactic foam (36-pcf ave. density) neutralizes negative buoyancy of fixed structure and equipment; and 4) movable lead ballast (26-lb bricks), up to 3,000 pounds, provides the means of adjusting trim and weight as calculated prior to each dive.

### Trim

The longitudinal moment (trim) of *DEEP QUEST* can be changed 30 degrees up or down during the dive by pumping oil from one to another of two, 18-inch-diameter, pressure-compensated, spherical tanks located fore and aft; each tank is initially half filled with 720 pounds of mercury which are separated from the oil by a rubber diaphragm and forced forward or aft by the pumped oil. A further refinement on *DEEP QUEST* is a port/starboard list tank system which

changes the roll or transverse moment ( $\pm 10$  degrees) of the vehicle in a fashion similar to the trim system.

### Stability

The surfaced metacentric height (GM) of *DEEP QUEST* is 12 inches; the submerged metacentric height (BG) is 3 inches. The short BG requires that careful consideration be given to attachment location and weight of additional equipment.

### Power

Main power is supplied by two, 120-VDC, pressure-compensated, lead-acid batteries supplying a total of 230 kWh which enable the vehicle to cruise at a speed of 2 knots for 18 hours. For scientific or other work instruments the following is available:

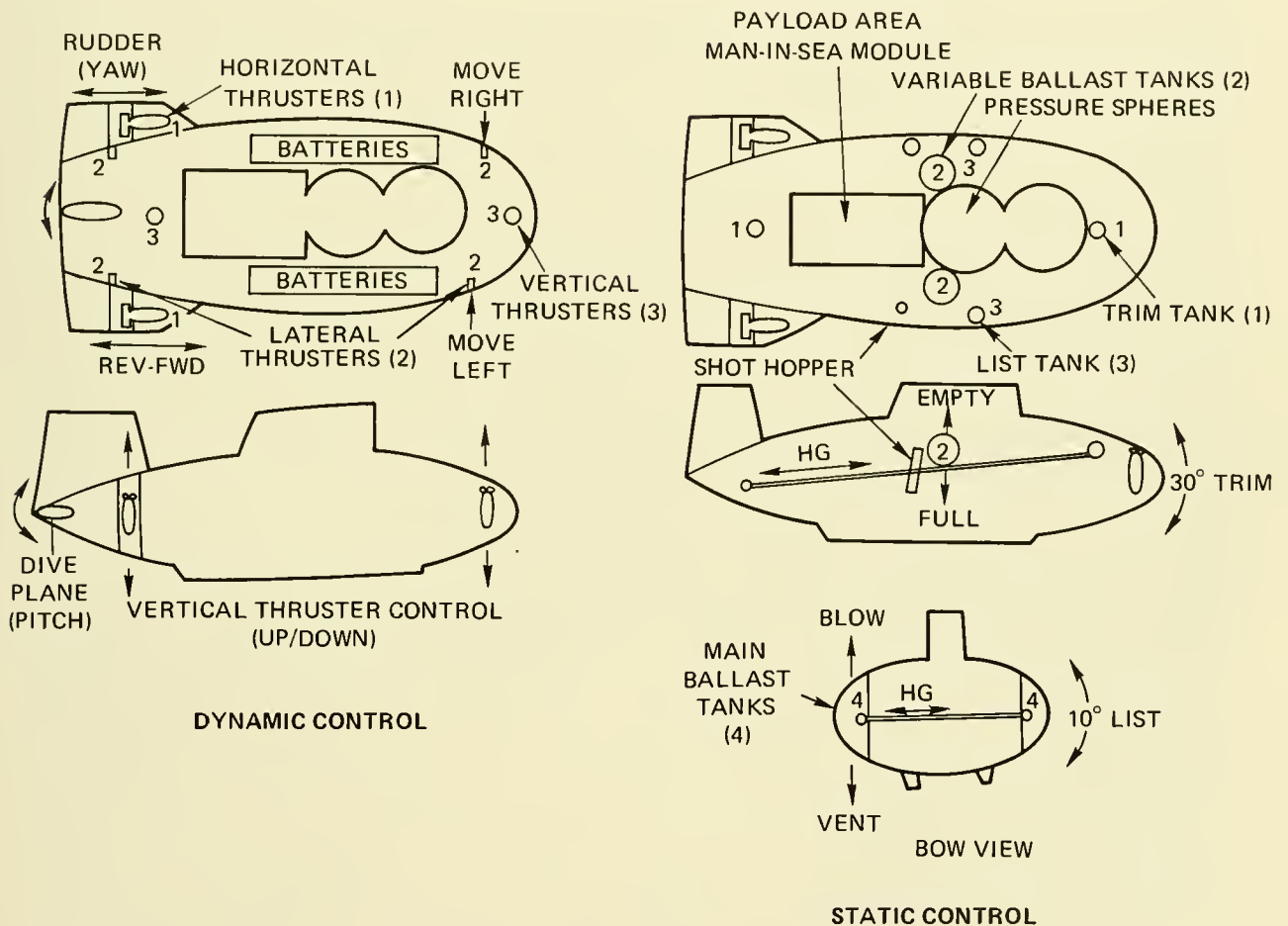

Fig. 2.5 DEEP QUEST's dynamic and static maneuvering ability.

120 VDC (nominal)

29 VDC  $\pm$  2%

115 VAC rms  $\pm$  2.5 V, 60 Hz, single phase

115 VAC rms  $\pm$  2%, 400 Hz, single phase

Two independent 28-VDC, silver-zinc batteries within the pressure hull provide 3.6 kWh of emergency power.

### Maneuverability

The axial, vertical, and lateral propulsive units, as described in Figure 2.5, in conjunction with stern planes and a rudder, provide five degrees of freedom (pitch, roll, heave, yaw, surge) and a dynamic maneuvering capability through the speed range of 0 to 3.5 knots. Static roll and pitch rotational moments are applied by weight transfer in the trim and list systems. An automatic pilot (course, speed and pitch angle) and an auto-

matic depth control are additional control adjuncts.

### External Attachments

**DEEP QUEST** offers several areas for attachment of instruments, and a jettisonable, steel framework or "brow" may be attached on the bow to carry a variety of instruments including a 700-pound coring device or a 1,500-pound reel of line. Aft of the pressure hull is an enclosed area within the fairing of approximately 385 cubic feet; this area may be used to accommodate instruments or tools of widely varying dimensions and weights. In the event that these areas are not desirable or usable, it is possible to attach instruments to the top of the vehicle by bolting down "Unistrut" configurations as desired (Fig. 2.6). Within the after pressure sphere two 19-

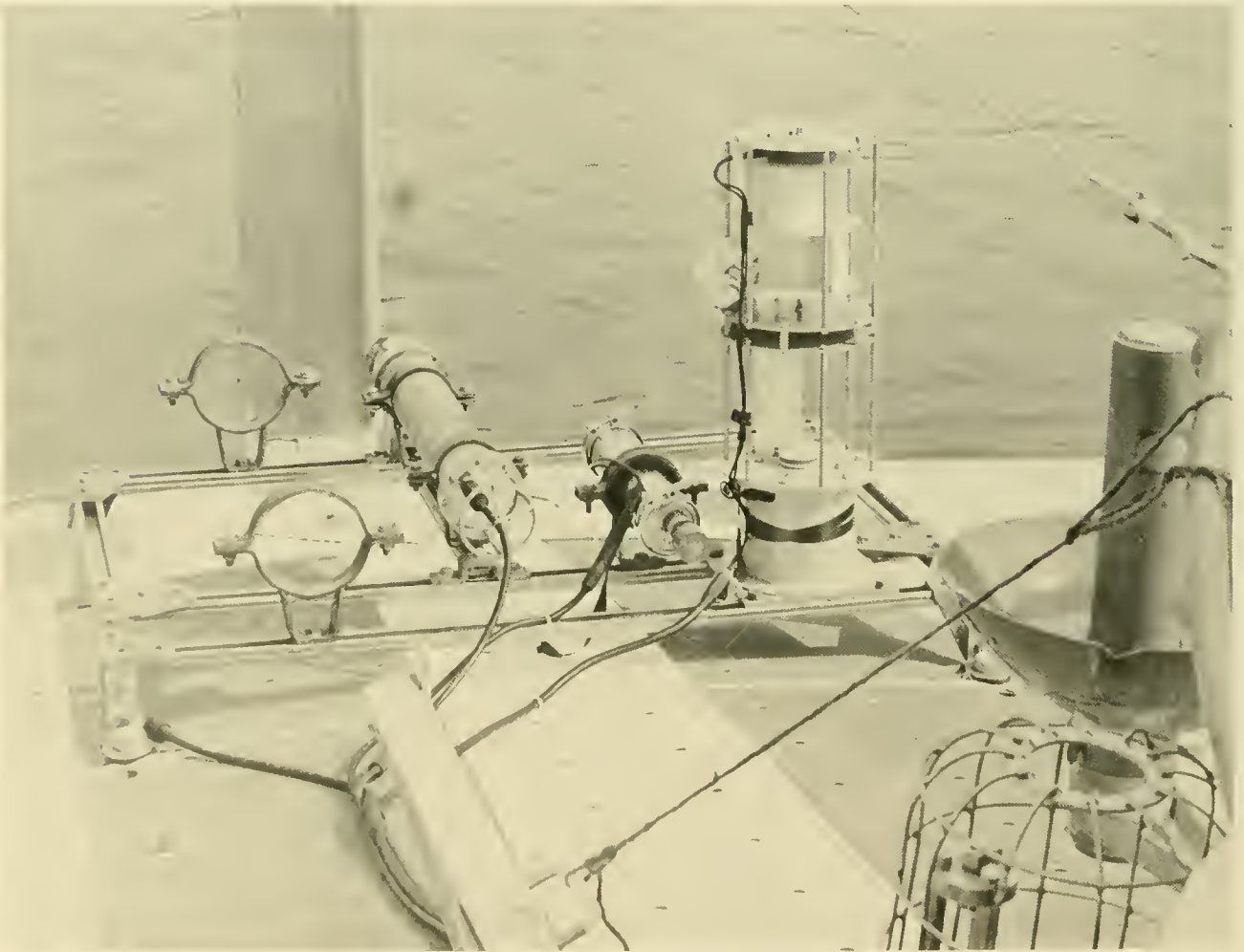

Fig. 2.6 "Unistrut" instrument attachment to *DEEP QUEST*'s fairing. (NAVOCEANO)



inch-wide, 59-inch-high, standard electronics racks are available for installation of equipment; within the entire pressure hull approximately 20 cubic feet of space are available for additional equipment. Electrical penetrations through the pressure hull are provided for additional equipment; these consist of twenty-six, 2-wire (No. 18) AWG circuits and four, 2-wire (No. 16) AWG circuits. Extra leads can be made available by alternate substitution means.

### **Lock-out/Lock-in**

A 25-inch-diameter door on the after pressure sphere is configured to join with a "man-in-sea" module to provide diver lock-out/lock-in facilities for at least two divers. The module, when installed, will occupy the enclosed area now available for additional instrumentation. A transfer bell may be attached to the bottom hatch of the after pressure sphere for transferring personnel to or from manned undersea stations at atmospheric pressure or to rescue personnel from disabled submarines configured to accommodate the transfer bell.

### **Payload**

In excess of 2,000 pounds (wet weight) may be carried within the diver module area. A total of 7,000 pounds may be accommodated by relocation of buoyancy (syntactic foam) material.

## **HUMAN CONSIDERATIONS**

### **Respiration**

Oxygen is carried within the pressure hull in four bottles (0.37 ft<sup>3</sup> each at 2,250 psi), two of which are spares. Oxygen is automatically bled into the cabin by a solenoid-actuated differential pressure control switch maintaining cabin pressure at 2 inches of water above a 1-atmosphere reference chamber. Carbon dioxide and other contaminants are removed by blowing a portion of the circulated air through lithium hydroxide/activated charcoal canisters. An emergency blower is available for backup contaminant removal. Cabin pressure is monitored and displayed on a gage in the forward sphere. Oxygen and carbon dioxide partial pressures are detected by sensors and displayed; a red light alarm is activated when these pressures are beyond allowable

limits (O<sub>2</sub>: 140 to 180 mm Hg; CO<sub>2</sub>: 8 mm Hg max.). A Mine Safety Appliance universal kit is carried to identify trace contaminants.

### **Temperature/Humidity**

With seawater temperature between 28° and 55°F, cabin temperature is controlled, as explained previously, at 70°F ± 10°F. Relative humidity is maintained at 60% ± 20% by condensation of moisture in the heat exchangers. All parts of the pressure hull's interior, with exceptions of the heat exchange portion and hatches, are covered with 5/8-inch-thick polyvinyl chloride (Ensolite) insulation.

### **Food/Water**

Normal diving food rations consist of sandwiches and other foods prepared daily prior to each dive. Emergency dehydrated food is carried to sustain four people for 48 hours. Water is carried in plastic containers.

### **Waste-Management**

Wide-mouth plastic jars enclosing vinyl bags are carried for collection and storage of liquid and solid wastes. Wescodyne germicide is used as a stabilizing agent and activated charcoal for odor control. A folding camp-type toilet seat with plastic waste bag is carried.

### **Fatigue**

Pilot and co-pilot are provided with cushioned seats in the forward sphere. No permanent facilities are provided for the two observers other than a foam-rubber cushion located on the deck between the pilot and co-pilot upon which the observer may lie to use the forward-looking viewport. The dimensions of the pressure hull are sufficient to provide headroom for standing and stretching.

## **EMERGENCY PROCEDURES**

### **Entanglement**

*DEEP QUEST's* streamlined fairings present minimal entanglement potential. Its manipulators, pan and tilt mechanisms and forward instrument brow are jettisonable. All propellers are shrouded and screened to prevent entanglement with rope or wire.

### **Power Loss**

An emergency power source is carried inside the pressure hull on each dive. In the

event of a total power (normal and emergency) loss the steel shot is automatically dumped. Emergency power can be used to operate jettisoning circuits, underwater telephone, radio, and life support equipment.

### Fire and Noxious Gasses

An emergency breathing system for four people is carried which consists of four full-face masks coupled to a common rechargeable LiOH/charcoal cannister and oxygen supply with a breathing bag which acts as an accumulator. A pressure of 1.5 inches of water above cabin ambient pressure is maintained in the emergency system to prevent contaminated air from entering. The system provides a total of 3 hours for each person. Two 2.5-pound CO<sub>2</sub> fire extinguishers are carried at all times. When a fifth person is carried, an OBA (Oxygen Breathing Apparatus) is added.

### Deballasting Loss

In the event that normal ballasting methods and power are lost, the following may be dropped to gain positive buoyancy as indicated:

Not included above are the jettisonable mechanical arms and brow and breakaway pan and tilt mechanisms (Fig. 2.7).

### Tracking Loss

If *DEEP QUEST* becomes separated from *TRANSQUEST*, it has several options while on the surface for communication and location. A radio direction finder on the support ship may home in on a 2182-kHz voice transmitter, or a Coast Guard aircraft may home on a 121.5-MHz signal transmitted from a self-powered, omnidirectional emergency beacon aboard the submersible. A transducer affixed to the bottom of the submersible allows for UQC communication when surfaced. A floodable sail over *DEEP QUEST*'s top hatch allows for opening of the hatch in inclement weather to flush out cabin air if required. Surface viewing capability without opening the hatch is attained through use of the sail-mounted television periscope. *DEEP QUEST*'s international orange sail and rudder provide excellent contrast against all spectrums of water color. A pressure-switch actuated, sail-mounted, flashing xenon light is provided for nighttime visual location.

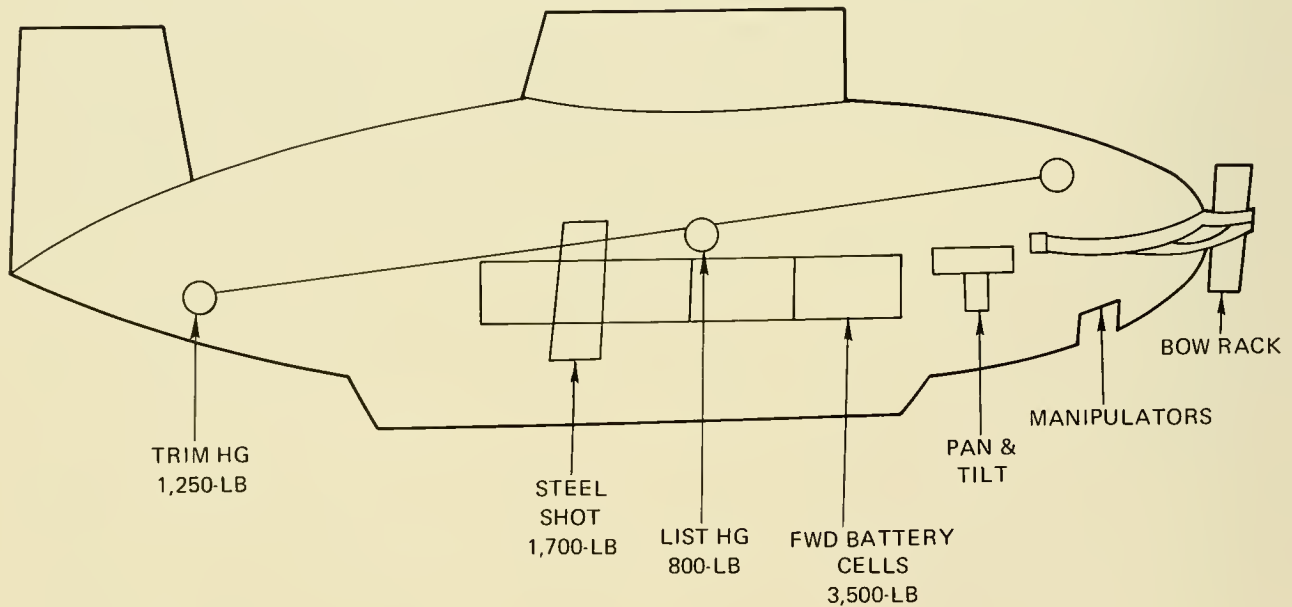

Fig. 2.7 DEEP QUEST's jettisonable components.

# SUPPORT REQUIREMENTS

## Transportation

As it is one of the larger deep submersibles, *DEEP QUEST* is normally considered only sea transportable. However, with the sail and stern planes removed, *DEEP QUEST* could be air (C-141) and land (tractor, trailer, rail) transportable. At its home port, San Diego, a marine railway is available to transport it in and out of its shop.

## Support Platform

The Motor Vessel *TRANSQUEST* (see Table 12.2 for specifications) was specifically designed to support *DEEP QUEST* in extended open-sea operations, but it is somewhat limited by its size (108 ft) and speed (6.2 knots max.).

## Launch/Retrieval Apparatus

(See sea state above.)

## Tracking and Navigation

Tracking of *DEEP QUEST* was outlined under Acoustics above and is utilized to vector *DEEP QUEST* to desired locations as well as to track her movements. Three systems are available aboard *DEEP QUEST* for navigation independent of the surface (Fig. 2.8). The first system consists of a gyrocompass (providing heading azimuth which is further corrected to true heading by a vertical reference gyro and the navigation computer), a Doppler sonar log (provides vehicle speed relative to the bottom), and an analog computer which processes the direction and speed information and plots the vehicle's course on an x-y plotter, as well as presenting the information to a

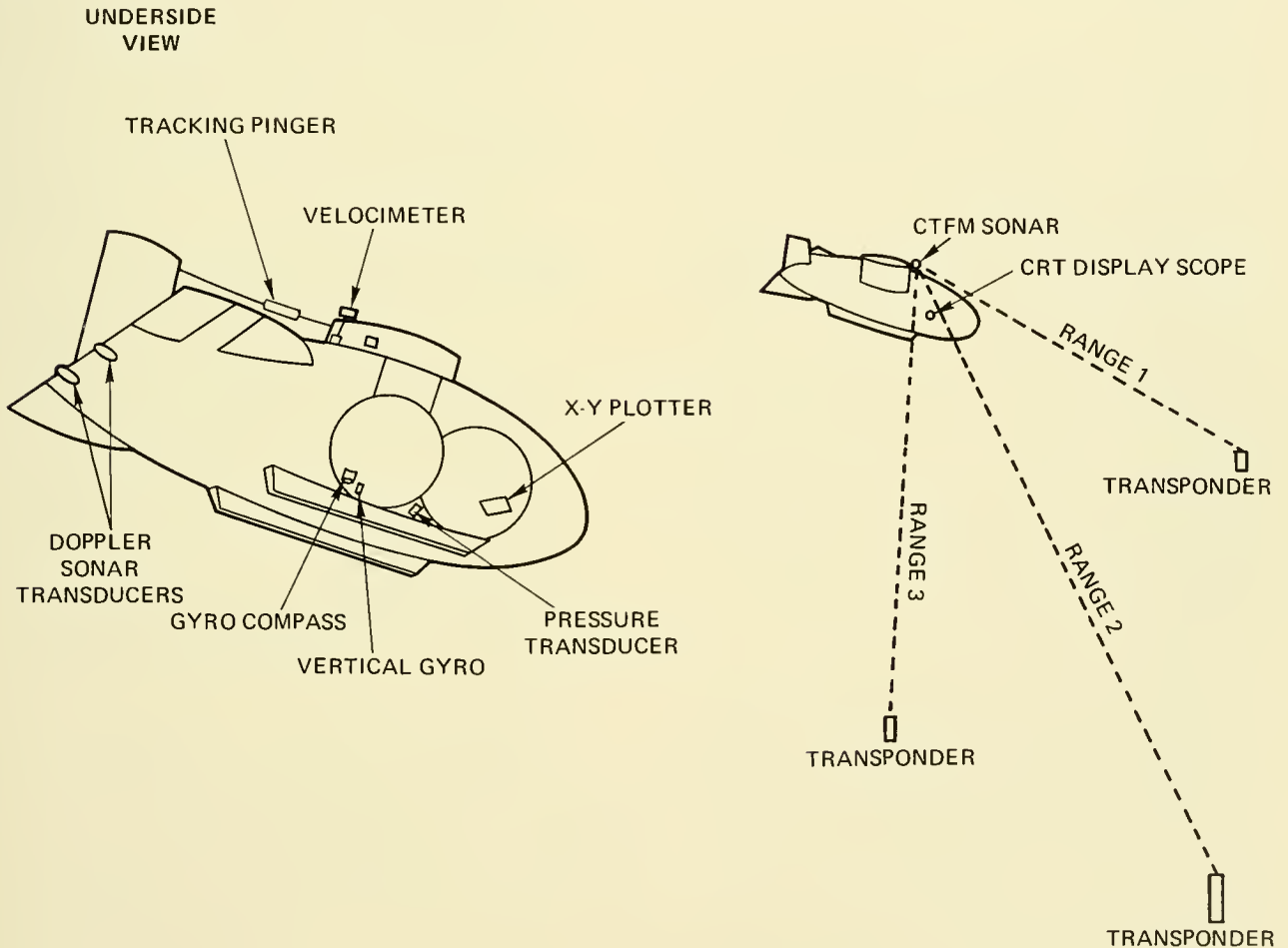

Fig. 2.8 *DEEP QUEST*'s navigational components.

data recorder. The second system uses gyro-compass or remote reading magnetic compass (Magnesyn) heading and flowmeter speed (or odometer distance) through the water to obtain a manual navigational track. A third system utilizes the laterally-trainable Straza Model 500 CTFM sonar mounted on the sail which transmits and receives sonar signals and generates both audio and visual outputs in the pressure hull and, in addition, provides a cathode ray tube with digital readout of range to a target. Using fixed bottom objects as landmarks or range and bearing of transponders placed on the sea floor, **DEEP QUEST** can employ the CTFM to obtain a plot of its progress relative to them. By using a down-looking depth sounder/strip chart recorder and upward-looking depth sounder in conjunction with the CTFM and transponders, accurate post-dive navigational charts may be constructed.

The **DEEP QUEST** submersible system is one of the most sophisticated in existence and was designed to accomplish such diverse tasks as research, surveying, engineering, search and retrieval, diver support and rescue. Relative to the shallower diving submersibles, it may appear unduly complex. Undoubtedly, one can do without a great number of **DEEP QUEST's** capabilities if the operational tasks are merely for viewing and simple work functions. The trade-offs are obvious: The simpler the submersible, the simpler the tasks it may perform. Nonetheless, the basic design and operational aspects outlined above must be confronted and solved by all submersibles to varying degrees; where one or several of these functions have been slighted—and no submersible is without fault—the weakness is apparent.

A common weakness, undoubtedly the most crucial obstacle to wide-scale submersible employment, resides in the operational concepts. Possibly influenced by independently-operating, self-sufficient military submarines, submersible architects have tended to overlook or underestimate the critical role played by surface craft in supporting extended open-sea operations. In the formative years, the many technical problems of deep submergence overshadowed this surface dependency, but, once they were solved and submersibles routinely dived without crippling malfunctions, inade-

quacies of surface support came into proper perspective and still plague vehicle owners. Future submersible designers must, if they hope to achieve more effective diving records, be cognizant of the fact that small, maneuverable, battery-powered vehicles are inextricably bound to their surface support platform for safety, sustenance and operational efficiency.

## REFERENCES

1. King, D. A. 1969 *Basic hydrodynamics*. in *Handbook of Ocean and Underwater Engineering*, McGraw-Hill Book Co., New York, p. 2-1 thru 2-32.
2. Warren, W. F. 1961 *Seawater Density in the Ocean as a Function of Depth and a Method of Utilizing This Information in the Design of Pressure Vessels Which Will Remain in a Constant Depth Range Between the Surface and Bottom*. Naval Ord. Lab. NOLTR 61-179, AD 273634.
3. McQuaid, R. W. and Brown, C. L. 1972 *Handbook of Fluids and Lubricants for Deep Ocean Applications*. Naval Ship Research and Development Lab., Annapolis, Md., Rept. MATLAB 360, 249 pp.
4. Busby, R. F. 1967 *Undersea penetration by ambient light and visibility*. Science, v. 158, n. 3805, p. 1178-1180.
5. Encyclopedia of Oceanography 1966 *Encyclopedia of Earth Science Series*, v. 1, edited by R. W. Fairbridge, Reinhold Pub. Corp., New York.
6. Personal Communication with A. Markel, Reynolds Submarine Services, Inc., Miami, Florida.
7. Lockheed Missiles and Space Corp. 1967 *DEEP QUEST Summary Description*. LMSC No. 5-13-67-3, Sunnyvale, California.
8. ———, 1968 *Lockheed DEEP QUEST Submersible System*. LMSC/DO80197, Revision B, Sunnyvale, California.
9. ———, *DEEP QUEST Research Submarine*. LMSC/DO15168 (unpub. manuscript).
10. ———, *DEEP QUEST—The Versatile Submarine*. Ocean System Marketing (Sales Brochure), Sunnyvale, California.
11. Shumaker, L. A. 1972 *New Developments in Deep Submersible Operations* (unpub. manuscript).

TABLE 2.1 SEA STATE CHART

Wind and Sea Scale For Fully Arisen Sea						
Sea-General		Wind			Sea	
Sea State	Description	(Beaufort) Wind Force	Description	Range (Knots)	Wave Height Feet Average	Significant Range of Periods (Seconds)
0	Sea like a mirror.	0	Calm		0	—
	Ripples with the appearance of scales are formed, but without foam crests.	1	Light Airs	1-3	0.05	up to 1.2 sec.
1	Small wavelets, still short but more pronounced. Crests have a glassy appearance and do not break.	2	Light Breeze	4-6	0.18	0.4-2.8
	Large wavelets. Crests begin to break. Foam of glassy appearance. Perhaps scattered white caps.	3	Gentle Breeze	7-10	0.6 0.88	0.8-5.0 1.0-6.0
2	Small waves becoming longer; fairly frequent white caps.	4	Moderate Breeze	11-16	1.4	1.0-7.0
3					1.8	1.4-7.6
					2.0 2.9	1.5-7.8 2.0-8.8
4	Moderate waves, taking a more pronounced long form; many white caps are formed. (Chance of some spray.)	5	Fresh Breeze	17-21	3.8	2.5-10.0
5					4.3	2.8-10.6
					5.0	3.0-11.0
6	Large waves begin to form; the white foam crests are more extensive everywhere. (Probably some spray.)	6	Strong Breeze	22-27	6.4	3.4-12.2
					7.9	3.7-13.5
					8.2 9.6	3.8-13.6 4.0-14.5
7	Sea heaps up and white foam from breaking waves begins to be blown in streaks along the direction of wind. (Spindrift begins to be seen.)	7	Moderate Gale	28-33	11	4.5-15.5
					14	4.7-16.7
					14	4.8-17.0
					16	5.0-17.0
8	Moderately high waves of greater length; edges of crests begin to break into the spindrift. The foam is blown in well-marked streaks along the direction of the wind. Spray affects visibility.	8	Fresh Gale	34-40	19	5.5-18.5
					21	5.8-19.7
					23	6.0-20.5
					25 28	6.2-20.8 6.5-21.8
9	High waves. Dense streaks of foam along the direction of the wind. Sea begins to "roll". Spray may affect visibility.	9	Strong Gale	41-47	31	7-23
					36	7-24.2
					40	7-25
					Very high waves with long overhanging crests. The resulting foam, in great patches, is blown in dense white streaks along the direction of the wind. On the whole, the surface of the sea takes a white appearance. The rolling of the sea becomes heavy and shock-like. Visibility affected.	10
49	7.5-27					
52	8-28.2					
54 59	8-28.5 8-29.5					
11	Exceptionally high waves (small and medium-sized ships might be for a time lost to view behind waves). The sea is completely covered with long white patches of foam lying along the direction of the wind. Everywhere the edges of the waves are blown into froth. Visibility affected.	11	Storm	56-63	64	8.5-31
					73	10-32
12	Air filled with foam and spray. Sea completely white with driving spray; visibility very seriously affected.	12	Hurricane	64-71	> 80	10-(35)





# 3

## CONTEMPORARY SUBMERSIBLE DEVELOPMENT

As surface craft progressed century-by-century from muscle, through sail, steam, diesel-electric and nuclear power, peaceful undersea explorers merely dabbled beneath the surface from cable-suspended spheres and open-bottomed diving bells. Then, in less than a score of years, mankind virtually leap-frogged to the greatest known ocean depths and produced an astounding array of undersea vehicles for science, industry and recreation.

One interested in undersea history cannot help but wonder: Why the 1960's? What pressures or inducements were then active to encourage investment of millions of dollars in undersea exploration that were not present earlier in the twentieth century, or, for

that matter, in any earlier period? Undoubtedly, economic gain was the major underlying motive, but what made several giant American corporations and numerous small companies and individuals believe there was a market or need for such capabilities? There is no single factor that prompted this surge of activity; instead, the influences of several separate and concurrent events were at work; for example:

- A demonstrated technological ability to reach the greatest known ocean depth in 1960,
- A space program amounting eventually to \$35 billion,
- Loss of the U.S. Navy nuclear submarine **THRESHER** resulting in a pro-

- gram recommending large sums for deep submergence,
- Increasing Federal funding for oceanographic programs,
- An oil industry moving farther out and deeper into the sea,
- Scientific reports detailing the many results and advantages of ocean study from manned submersibles,
- Serious scientific desire to study the deep sea *in situ*,
- A burgeoning market in recreational undersea diving,
- A military interest in materials and techniques for deep submergence vehicles,
- Increased recognition of mineral resources and ever dwindling terrestrial resources,
- Forecasts by military and government officials and private industry of the promising aspects for deep submersibles, and
- Individual awareness of the grandeur and beauty of the deep sea through tasteful and exciting cinematic and television productions.

To varying degrees, these events and pressures worked to produce a 1970 worldwide fleet of over 100 shallow and deep submersibles—up from less than a handful a decade earlier. Another factor, impossible to measure, is the pure desire of man to challenge and overcome the hostility of the deep ocean. When he replied “Because it’s there!” to one inquiring why climb a mountain, Mallory also offered an explanation for many who challenge the abyss.

## BATHYSPHERE TO BATHYSCAPH (1934–1960)

*“When once it (the deep ocean) has been seen, it will remain forever the most vivid memory in life, solely because of its cosmic chill and isolation, the external and absolute darkness and the indescribable beauty of its inhabitants.”*

So wrote naturalist William Beebe (1) in describing the events leading to his record-breaking, 3,028-ft dive in 1934.

Before Beebe and his engineer associate, Otis Barton, descended to this unprecedented depth, man’s involvement with the

deep ocean reached a maximum of 600 feet (2); this was with the aid of heavy metal diving suits which reportedly seized or contracted arthritis at the joints within a few hundred feet of depth.

Barton’s **BATHYSPHERE** (a word coined by Beebe meaning deep sphere) was a single spherical steel casting 54 inches in inside diameter and 1½ inches thick. The 2½-ton sphere was supported on deck by a set of wooden skids (Fig. 3.1). A 14-inch-diameter entrance hatch was sealed by a 400-pound steel door bolted to the sphere. Watertight integrity between door and sphere was accomplished by a circular metal gasket fitting into a shallow groove and packed with white lead to prohibit leaking at shallow depths. Three viewports were available, although only two were used; these were composed of fused quartz glass 3 inches thick and 8 inches in diameter. The third viewport was sealed with a metal plug when spare windows were subsequently exhausted. Oxygen was carried in the sphere in two 80-gallon-capacity tanks at 1,800 psi and automatically bled into the cabin. Carbon dioxide was removed by circulating air through soda lime and calcium chloride was carried to control humidity.

The **BATHYSPHERE** was lowered from the surface on the end of a non-twisting steel-core cable of 29-ton breaking strength. A second cable served as a conductor for a telephone and two lights, which were aimed through a viewport for external illumination. The power cable was tied by rope to the lift cable at intervals and passed into the pressure sphere through a stuffing box. Power for the lights was provided by a surface generator and a battery supplied the telephone power. In the event of telephone failure, an arrangement was made whereby a light in the sphere could be keyed from above to signal; a further arrangement made it possible to key a light on deck from within the pressure sphere.

Built in 1929 by Barton, and donated by him to the New York Zoological Museum in 1940, the **BATHYSPHERE** progressively made record dives over a 4-year period off Bermuda. Beebe’s purpose in these dives was to pursue his studies of deep-sea organisms which he began several years earlier



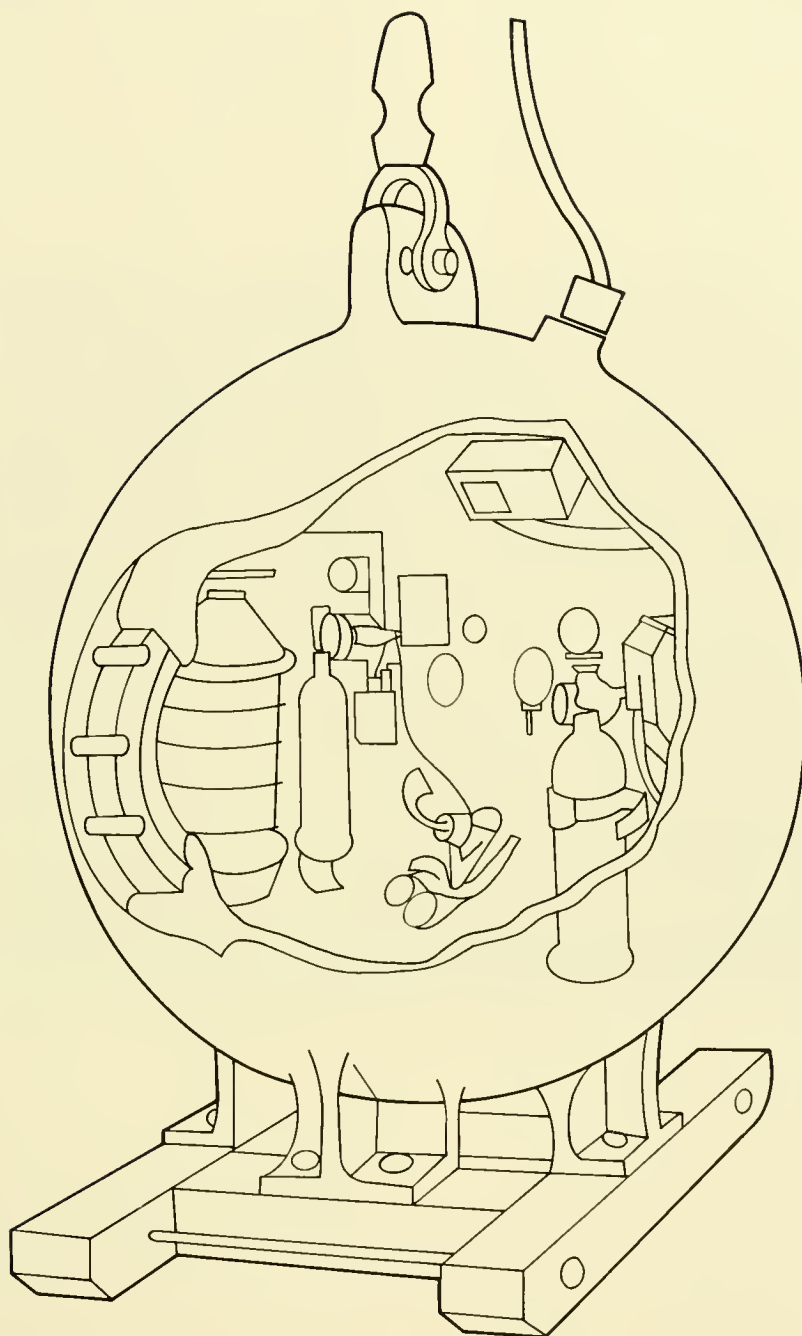

Fig. 3.1 Internal arrangement of the bathysphere of 1934. From left to right—Chemical apparatus with its blower; four trays and pan; oxygen tank and valve; telephone coil and battery box—the telephones are plugged into this box and it is connected by the wire shown on the two hooks above the oxygen valve, with the telephone wires in the communication hose; thermometer-humidity recorder, and below it the left hand sealed window; barometer; switch-box at top of sphere; central observation window, immediately below switch-box; oxygen tank and valve; searchlight. The communication hose is shown as it enters the bathysphere through the stuffing-box. [From Ref. (1)]

from a laboratory on Nonsuch Island. Financial support came from both the Zoological Museum, where he was Director of the Department of Tropical Research, and later from the National Geographic Society.

Beebe's accounts of *BATHYSPHERE*'s dives in *Half Mile Down* are exciting, informative and extremely readable. Indeed, his voyages aroused public interest to the point where his narrative during the 1,500- to 2,200-foot portion of a dive on 23 September 1932 was transmitted live to the United States and Europe by the National Broadcasting Corporation. Professor Beebe in the 1930's and 40's was as familiar an undersea figure as Jacques Cousteau would be a score of years later.

In spite of Beebe's successes the *BATHYSPHERE* and its mode of operation has several deficiencies for the undersea biologist; some were minor, others were potentially serious.

- With a weight displacement ratio of 1.49, the *BATHYSPHERE* would sink like a rock if the cable broke.
- External pressures squeezed, from several inches to several feet, the electrical cable into the cabin on each dive. Packing the cable in ice to contract it before tightening down on the stuffing box alleviated this problem somewhat.
- A voltage drop from 110 V to 75 V caused by the resistance in 3,600 feet of cable reduced the lights' candle power (2,628 to 732) and required switching to a more powerful generator for photography. The lights, shining through the glass viewport, heated it to a dangerous level.
- The cramped quarters in the 4½-foot sphere made a dive of 3½ hours almost the limit of endurance.
- Every up-down motion of the surface ship was transmitted to the sphere and only a flat calm allowed a specified depth to be maintained.
- Although corrected to an acceptable degree—by packing with white lead lubricant—leakage around viewports and hatch cover occurred frequently.

The lack of horizontal maneuverability prompted Beebe to take, what must be considered, daring measures on shallow reef-exploring dives. Towed along by the surface

ship, and with fixed wooden rudders attached to stabilize the sphere, Beebe observed the bottom at close range and relied solely on voice command to the ship to raise the *BATHYSPHERE* when a vertical obstacle appeared in his path. On one such voyage, he relates an encounter with a towering coral head which came perilously close to colliding with the dangling sphere. One must stand in awe of these early pioneers, for in the thirties a parting of the cable, even at shallow depths, virtually guaranteed a death warrant.

To one early undersea adventurer, Menotti Nani, the technical and environmental perils of deep submergence were apparently incidental. Mr. C. R. Vincent, an early 1930's metal alloys fabricator of Newark, New Jersey, was approached by Mr. Nani to construct a 300-ft, 1-man submersible of his design. Mr. Vincent, now of Houston, Texas, recently related this experiment in a February 1974 issue of "The Ensign" and called the little boat another "Novelty of the Depression Era." Constructed almost entirely of Krupp stainless steel, the submersible (Fig. 3.2) had four tiny glass viewports aft and relied upon the ejection of compressed air for propulsion. Mr. Nani's original intention was to demonstrate the feasibility of this type of submersible for observation and, with modifications, submarine rescue. But, except for a few test dives in the Passaic and Hudson Rivers, the prototype never realized its potential and slipped quietly into obscurity. Its demise, however, could not be attributed to lack of daring on Mr. Nani's part, for at one point his plans envisioned riding in the submersible as it was dropped from the George Washington Bridge. The New York City police, however, considered the plan to be without scientific merit and refused permission.

In spite of the high public interest and many scientific revelations of the *BATHYSPHERE*, a period of deep-sea inactivity followed its successful dives. To the clairvoyant, a hint of where the next activity might arise could have come from the many references by Beebe to the stratospheric ballooning accomplishments of a Swiss physicist, Auguste Piccard, who displayed a keen interest in Beebe's dives.

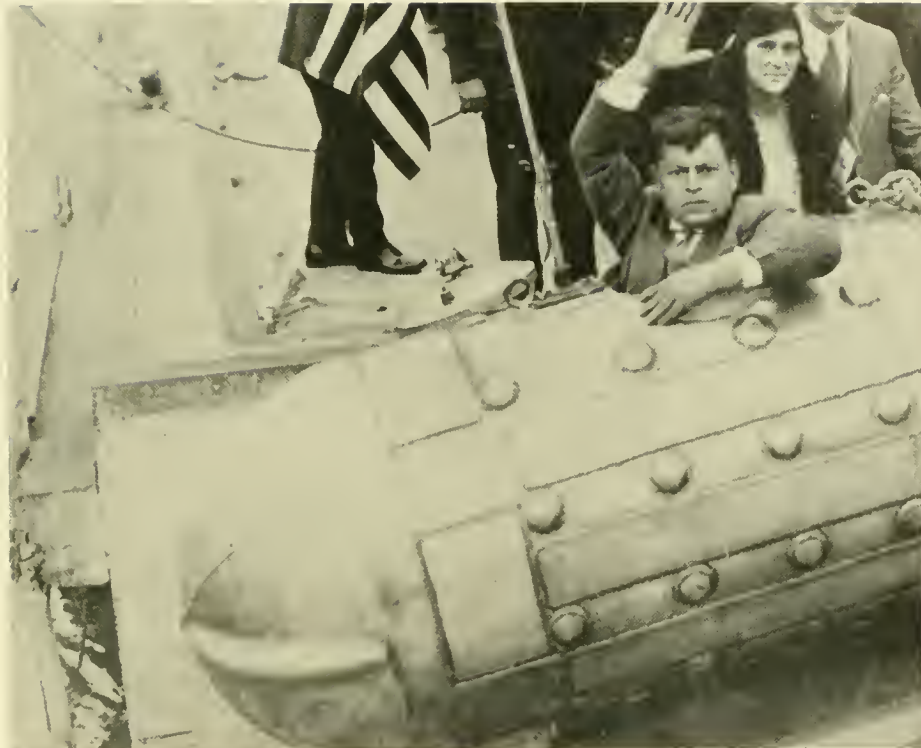

Fig 32 Inventor Menotti Nani waves a grim goodbye as he prepares for a plunge into the Hudson River (Mr C. Richards Vincent, Houston, Tex.)

Piccard, a towering, innovative research scientist, was interested in the study of cosmic rays, and, because of the earth's protective atmosphere, designed a stratospheric balloon to carry him and his instruments above the atmosphere for unhindered measurements. On August 18, 1932, the Professor ascended from Zurich to a world record 72,177 feet. Financed by the Belgium National Fund for Scientific Research or Fonds National de la Recherche Scientifique (FNRS), the balloon was named *FNRS*, and in 1933 its gondola hung prophetically over the *BATHYSPHERE* in the Hall of Science of the Century of Progress Exposition at Chicago.

Beebe was a biologist whose major interest in the *BATHYSPHERE* was its ability to

provide him with a better means to conduct his studies; he was a user of technology, not a developer. Piccard, on the other hand, became a developer of technology and a user of the laws of physics. His initial interest was cosmic ray study which forced him to modify and apply the stratospheric balloon in the same manner that Beebe applied the *BATHYSPHERE*. Subsequently, he developed a vehicle the marine scientist could use to penetrate the oceans as he did the atmosphere (3). The seed of this undersea vehicle germinated for some time in the Professor's mind, and in 1939 the FNRS granted him some \$25 thousand to construct a bathyscaph or *deep boat*, christened *FNRS-2*. But before he progressed into the actual construction stage,

World War II intervened and halted all thoughts of peaceful research.

At the commencement of WWII the following state-of-the-art existed in military and other undersea circles: Diesel-electric surface-powered military submarines were operating at a maximum depth of 312 feet and, under normal conditions, stayed underwater some 20 hours using what air was in the boat when the hatches were closed. Lithium hydroxide was scattered throughout the submarine for carbon dioxide absorption if the situation warranted. Ambient-pressure diving, *i.e.*, where the diver is exposed to sea pressure and not inside a pressure-resistant suit or capsule, had progressed to the stage where 243-foot dives, breathing helium-oxygen, were a practicality (4). Earlier submarine disasters in 1925 (*USS S-51*) and 1927 (*USS S-4*) demonstrated the need for development of better diving techniques and rescue devices. In conjunction with the Bureau of Mines, the U.S. Navy's Bureau of Construction and Repair began investigations into all aspects of prolonged deep-diving at ambient pressure. This work progressed to a point where an Experimental Diving Unit was established in Washington, D.C., in 1927, which went on to develop chambers for rescuing trapped submariners, as well as decompression tables and gas mixture for divers. The benefits of this research paid off in 1939 when the *USS SQUALUS* went down in 243 feet of water off the Isle of Shoals in the North Atlantic. Forty of the trapped crew were rescued by the newly developed rescue chamber and with the assistance of divers breathing helium-oxygen.

Ambient pressure diving up to 1943 was, *BATHYSPHERE*-like, tethered to the surface for support in the form of air and vertical movement. Devices did exist for the diver to carry his own oxygen or air supplies, but oxygen is toxic at depths greater than about 35 feet, and the compressed air device, invented by a French Naval officer, Commander Le Prier, in 1925, released a diver-regulated, continuous flow of air into a face mask which, by design, imposed very short diving limits.

In 1943 another French Naval officer, Jacques Cousteau, teamed with engineer Emil Gagnan and produced the demand reg-

ulator to provide air from tanks only when the diver inhaled and automatically increased the air pressure to equalize pressures inside the body with water pressure outside. The demand regulator and the imaginative artistry of Cousteau later produced a revolution in the field of recreational and commercial diving.

With the close of hostilities, Piccard once again asked for, and received, the pre-war funds allocated for *FNRS-2*. *FNRS-2* served as the prototype for all future bathyscaphs. Its purpose was to dive deep (10,000 ft originally), allow the passengers to view outside, range about the bottom and to do so with no cable to the surface and with a wide margin of safety.

In many respects, *FNRS-2* was a reversal of the principles which made *FNRS* soar. The pressure sphere, with a W/D ratio greater than 1, would sink unless restrained; the Professor constructed an oval-shaped, thin, metal-walled float wherein six compartments held 6,600 gallons of gasoline which, being lighter than water, would float and hold the cabin (Fig. 3.3) at the surface.\* Gasoline was valved off by the pilot to begin the descent, and water immediately replaced the gasoline to maintain a pressure within the tanks equal to that without. *FNRS-2* carried several tons of iron shot in steel tanks which were restrained from dropping by doors held closed with electromagnets. In the event of a complete power failure, the doors opened and dumped all shot. Similarly, other tanks held scrap iron and gravel for additional ballast which also jettisoned in the "fail-safe" manner. The iron shot could be dumped incrementally to slow down descent or increase ascent. A 7-foot-long cable attached to the sphere held a 100-kilogram (wet weight) flat-iron-shaped concrete clump which served to hold *FNRS-2* in stable equilibrium just off the bottom.

Instead of a cable to the surface, *FNRS-2* carried its own power in the form of two lead-acid storage batteries which ran two 1-horsepower motors (mounted port and starboard at the base of the float). External lights were provided for viewing and a carbon dioxide removal system and oxygen were carried within the pressure sphere. The motors served to provide a measure of horizontal maneuverability for bottom exploration.

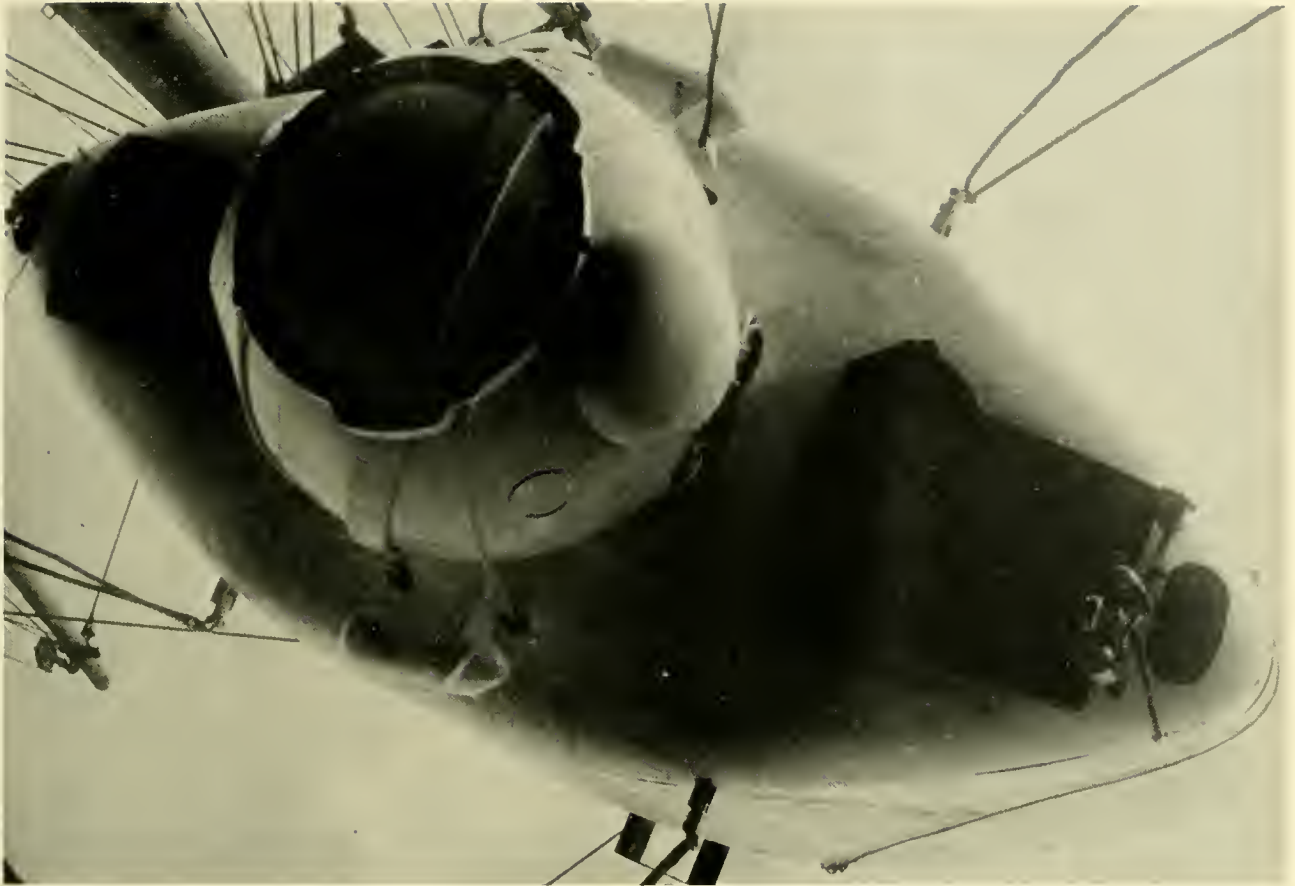

Fig. 3.3 Bottom view of *FNRS-2* showing pressure sphere and float. (Jacques Piccard)

The pressure sphere was larger than the *BATHYSPHERE* (6-ft 7-in. diam.) and was of two cast-steel (Ni-Cr-Mo) hemispheres bolted together at an equatorial flange. Entry through the hatch was made while *FNRS-2* was on deck; once the passengers were inside, there was no way for them to get out unless the bathyscaph was lifted clear of the water.

Of the many innovations produced by Piccard, the viewports of *FNRS-2* stand out as truly significant. Having witnessed the *BATHYSPHERE*'s problem with cracking and chipped glass, Piccard, as early as 1939, teamed with countryman Professor Guiltisen and produced a conically-shaped window of acrylic plastic 5.91 inches thick, 15.75-inch outside diameter and 3.94-inch inside diameter. The conical shape offered wide-angle viewing (Fig. 3.4) and plastic, unlike glass, does not fail catastrophically; instead, it deforms elastically and passes on excess stress to its adjacent parts. This configuration and plastic are the bases of all submersible view-



Fig. 3.4 Professor Auguste Piccard inspecting an acrylic plastic viewport, one of his many contributions to deep submergence (Jacques Piccard)

ports today except for the Japanese submersible *KUROSHIO II*.

Other technological areas where the *FNRS-2* pioneered was in the pressure compensation of its batteries and the design of thru-hull electrical penetrations; both are discussed more fully in Chapter 6. As he explained in *In Balloon and Bathyscaphe* (3), Piccard did not consider deep diving a particularly dangerous undertaking as long as one complied with the applicable laws of physics and added a margin for safety. Consider, for example, the pressure sphere which had an operating depth of 2.5 miles and a collapse depth of 10 miles, and the plastic viewports which would only deform permanently at a computed ocean depth of  $18\frac{3}{5}$  miles. There are so many areas in which the innovative Swiss physicist laid the groundwork for future deep submergence vehicles that a mere listing would not do justice to his accomplishments. Not only did he solve a great many technical problems, but he also identified those areas where additional research was required. More importantly, his efforts and subsequent narratives served to galvanize the marine engineering community into thinking of the problems of deep submergence and the oceanographer into thinking of its benefits. For this, contemporary participants of deep submergence are indebted.

On the 26th of October 1948, *FNRS-2* made its first test dive to 84 feet off Cape Verde with Piccard and French biologist Dr. Theodore Monod aboard. The program called for an unmanned dive, which was subsequently conducted to 4,544 feet on the 3rd of November, and, when *FNRS-2* surfaced, Piccard met with a problem neither he nor his successors have solved successfully: Heavy weather. With seas too high for its support ship *SCALDIS* to retrieve it, the float was emptied of gasoline after a few hours of ponderous towing and replaced with carbon dioxide, but even so, the float, not designed for towing, was so damaged that further diving was precluded. A few weeks earlier, Otis Barton took an improved bathysphere called *BENTHOSCOPE* down to 4,488 feet off Santa Cruz Island, California.

The French Navy, who lent a great deal of assistance to Piccard in 1948, was presented

the *FNRS-2* in 1950 as an apparent result of disenchantment with bathyscaphs on the part of the Fonds National. At Toulon, the French made several modifications to the newly-designed *FNRS-3*; the most important being a new float designed for towing and a chute-like affair leading down to the original pressure sphere within which the occupants could enter or leave the cabin with the vehicle in the water. *FNRS-3* began diving under the command of Captain George Houot (5) in June 1953 and by February 1954 reached the unprecedented depth of 13,700 feet in the Mediterranean Sea.

Still undaunted, Professor Piccard, now joined full-time by his son Jacques, pressed on with his concept. With financial aid from the Swiss government and technical assistance and grants from Italian industry in the city of Trieste, they once more began their quest for depth in the form of the new bathyscaph *TRIESTE* in the spring of 1952. On the first of August 1953 the bathyscaph was launched.

The diving principles for *TRIESTE* were identical to those of *FNRS-2*; the major modifications were in dimensions, capabilities and, particularly, in the float, now designed for surface towing. Specifically, the following modifications took place:

- The pressure sphere was the same dimension as that of *FNRS-2* but was of forged steel—stronger and more malleable than cast steel.
- Electrical power was from silver-zinc batteries carried in the pressure sphere.
- The viewport in the hatch, now on hinges, could be used to view externally owing to installation of a plastic window in the access trunk. (*FNRS-2*'s hatch viewport was blocked by the apparatus holding the hatch in place.)
- The float held almost four times as much gasoline (22,600 gal) as *FNRS-2*, was stronger and was cylindrically shaped with a keel for better towing characteristics. A floodable vertical access trunk ran through the float to the sphere for ingress/egress to the cabin when *TRIESTE* was afloat. Tanks fore and aft in the float could be filled with air on the surface to attain greater free-board.

These and many other improvements carried **TRIESTE** to 10,392 feet by September 1954 off Ponza, Italy.

In 1957 the U.S. Navy's Office of Naval Research provided funds for a series of 26 dives by its civilian oceanographers and naval officers out of **TRIESTE**'s home port of Castellemare (6). Encouraged by this new approach to deep-sea studies, the Navy purchased **TRIESTE** in 1958 from Auguste Piccard for \$250,000 (7) and transported it to San Diego, California where it came under control of the Navy Electronics Laboratory (now the Naval Undersea Center). At NEL, **TRIESTE** received a facelifting in the form of a new pressure sphere, built by the German firm of Krupp, which allowed it to operate to a depth of 36,000 feet (the Terni sphere was limited to 20,000 feet) and an increase in the float of 6,200 gallons to accommodate the new 28,665-pound sphere (8).

By mid-October 1959 **TRIESTE** (Fig. 3.5) was fully assembled and made ready for its first deep-sea dives off Guam under the aegis of Project NEKTON. The French-held record by **FNRS-3** fell on 15 November 1959 with a dive to 18,105 feet with Jacques Piccard and NEL biologist, Dr. Andres Rechnitzer, aboard **TRIESTE**. Eight dives later, on 8 January 1960, a 22,560-foot dive by Piccard and Navy Lieutenant Don Walsh saw this record fall, and on the next dive, Piccard and Walsh reached the very bottom of the Challenger Deep: 35,800 feet on 23 January 1960—the contest was over. **TRIESTE** demonstrated that any ocean depth could be safely reached. The drama of these early years is presented in detail by Auguste Piccard (3), Captain Houot (5) and Jacques Piccard (9) in their books which chronicle the pioneering events leading up to the 1960 dive; for this reason the many technical problems and discouragements along the way are left out of the preceding account.

Just north of **TRIESTE**'s earlier port at Castellemare was a little noticed effort to build a deep-diving vehicle, but in this case the Italian builder, Pietro Vassena, intended to build a submersible for the recovery of wrecked ships (10). The submersible (Fig. 3.6) was constructed from a "torpedo snorkel" submarine built during the war. As early as 13 March 1948, Mr. Vassena and a companion

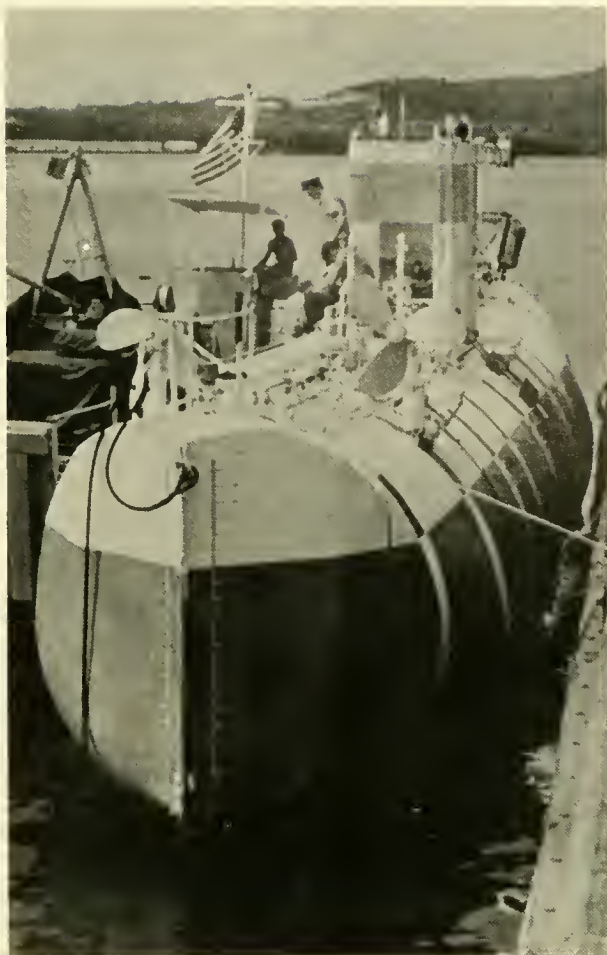

Fig 3.5 **TRIESTE** just prior to its Deep Dive. (Larry Shumaker)



Fig. 3.6 Pietro Vassena in the conning tower of his submersible for the recovery of wrecked ships. (Gianfranco Vassena)

reached a depth of 1,234 feet in Lake Como, but later, on an unmanned test dive, a lift cable broke and it was lost.

Elsewhere throughout the world, submersible activity in the 1950's was minimal. Not surprising, Japan, a country dependent upon the sea for 64 percent of its protein needs (2 percent in the U.S.), was an early user of submersibles. While Beebe dived to provide biological information of an academic nature, Dr. Naoichi Inoue, Head of the Faculty of Fisheries at Hokkaido University, initiated design and construction of the *BATHYSPHERE*-like *KUROSHIO* (Fig. 3.7) to investigate a major factor in his country's nutrient resources. By 1960 the 650-ft, 3-man *KUROSHIO* conducted 380 dives for benthic (bottom dwelling) and nektonic (free-swimming) fisheries studies off the coast of Japan. Retired in 1960, *KUROSHIO* was replaced in the same year by *KUROSHIO II*, a larger, maneuverable, more capable successor to its earlier namesake.

In the United States two submersibles appeared in the fifties: *SUBMANAUT* and *GOLDFISH*. Built by Martine's Diving Bells, Inc., of San Diego, California, *SUBMANAUT* (Fig. 3.8) used diesel/electric power on the surface and batteries while submerged. Originally designed for an operating depth of 2,500 feet, installation of a 3-inch-thick, 13-foot-long, plastic wrap-around window for photography decreased its capability to 600 feet. Launched in 1956, *SUBMANAUT* shot underwater films for various movie companies before it was shipped to Miami, Florida in 1958 from where it traveled to the Bahamas, Cuba, Italy and Bermuda to shoot other movie and television footage. In military submarine fashion, *SUBMANAUT* made several journeys, e.g., Miami to the Bahamas, on the surface under its own diesel/electric propulsion. In its most notable assignment, *SUBMANAUT* was featured in the MGM movie *Around the World Under the Sea* (11).

The shallow diving (100-ft) *GOLDFISH* was the 1958 creation of an ex-Navy submariner, Mr. Burt Dickman of Auburn, Indiana. *GOLDFISH* was a prototype submersible for investigating and photographing insurance claims on sunken vessels, but it never realized this potential although it carried sev-



Fig. 3.8 Edmund Martine's *SUBMANAUT* used diesel engines for surface power and batteries when submerged. (Edmund Martine)

eral hundred people into various Indiana lakes over the next 10 years.

Displaying remarkable foresight in the requirements for manned submersibles, Jacques Cousteau, as early as 1953, began design on the 1,000-foot, small, maneuverable *DIVING SAUCER* (Fig. 3.9) which was launched in 1959. Cousteau's desire was to build a submersible from which scientists could observe and photograph oceanographic phenomena in comfort and with a degree of access to undersea valleys and narrow canyons not attainable by the large, cumbersome bathyscaphs. Cousteau dived several times in *FNRS-3* and saw the weak and strong points of the underwater elevator. Several bathyscaph features, such as conical,



Fig. 3.9 Cousteau's *DIVING SAUCER* The forerunner of Bathyscaph progeny (Westinghouse)



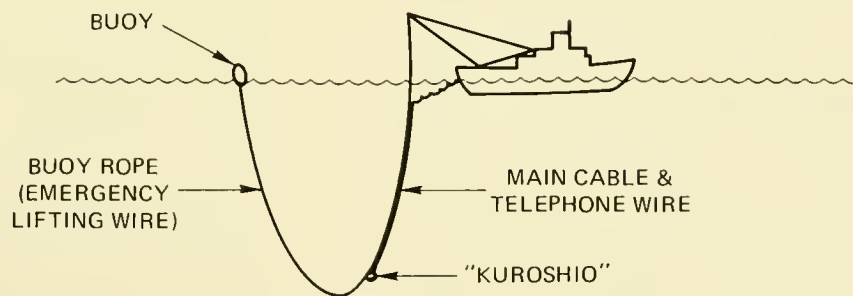
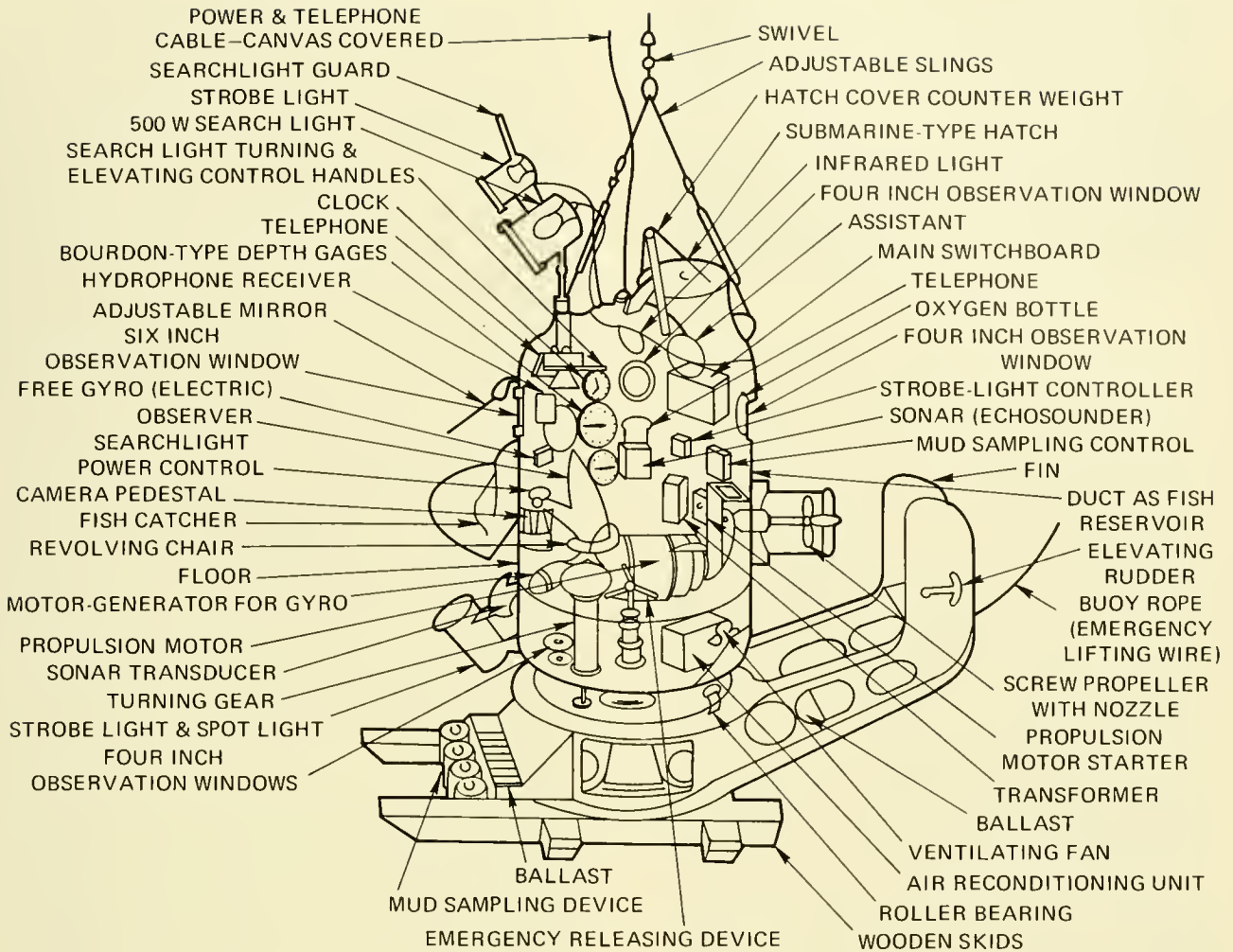

Fig. 3.7 KUROSHIO I. (Courtesy of N. Inoue)

plastic viewports and pressure-compensated batteries went into the **DIVING SAUCER**, but the high degree of transportability, comfort, better viewing, and maneuverability were new to the submersible scene. The first

pressure hull, a disc-shaped, 6-foot 7-inch-diameter, 5-foot-high, positively-buoyant, steel structure was lost in 3,000 feet of water off Cassis in 1967, during an unmanned test dive, when the lowering cable

snapped. A cable-suspended weight carried the hull to 3,300 feet. Six years hence, Cousteau reports seeing the hull on an echo sounder "floating at anchor" 30 feet above the bottom. A second hull was completed, and **DIVING SAUCER (SP-350)** commenced diving in 1959 in the Caribbean from its support ship **CALYPSO** which carried a stern-mounted, 10-ton, articulated, hydraulic "Yumbo" crane. This was the first open-sea "submersible system." With **DIVING SAUCER** in the hold of **CALYPSO**, the submersible could be transported safely for long distances at 12 knots, deployed and retrieved at the diving site with the Yumbo crane and repaired or maintained at sea in the support ship's hold. At the sacrifice of great depth capability, Cousteau brought flexibility and wide-ranging to submersible operations. Cousteau believed speed to be the enemy of observation; he described the slow-moving (0.6-knot cruising speed) **DIVING SAUCER** as ". . . a scrutinizer, a loiterer, a deliberator, a taster of little scenes as well as big. She gave us six-hour periods in which to study accurately the things below" (13).

In one case **DIVING SAUCER** pushed technology beyond its limits; the case being its original nickel-cadmium batteries which short-circuited and burned early in the test dives. The reason lay in the batteries' pressure-compensated fiberglass boxes which were poor heat conductors and allowed the compensating oil to reach boiling point from battery-generated heat. Brass battery boxes with gas exhausts replaced the fiberglass boxes, but gasses generated in the new boxes and they too exploded. Conventional lead-acid batteries replaced the nickel-cadmium cells, and **DIVING SAUCER** proceeded to dive with little further trouble from this source.

So far as can be determined, **DIVING SAUCER** was also the first to use the positively-buoyant pressure hull itself as a "fail safe" mechanism. At submerged trim, the submersible was neutrally buoyant; to surface, a 55-pound iron weight was mechanically dropped and **DIVING SAUCER** rose bubble-like to the surface.

The submersible scene, when **TRIESTE** ushered in the decade of the 60's with its record dive, may be described as "simmer-

ing." The achievement of record depth by **TRIESTE** was duly noted in the press and trade journals, but the space program in the United States completely dominated research development programs. The Federal financial climate, however, was friendly towards other exploration-technologic endeavors.

## PRE- AND POST-THRESHER (1960-1965)

In the years 1960 through 1963 eleven new submersibles appeared; their intended purposes varied, but they were all relatively small (2-man) and shallow diving (less than 600-foot operating depth); the exception being the French Navy's bathyscaph **ARCHIMEDE**, a 1961 replacement for the aging **FNRS-3**. Capitalizing on the lessons learned from **FNRS-3**, **ARCHIMEDE** could dive to any known ocean depth; its power supply was increased for greater maneuvering; the pressure sphere was enlarged to accommodate more research instrumentation; and its float was designed for towing at speeds up to 8 knots.

In these early sixties, private industry's incentive to build a submersible is not entirely clear. In the case of government-owned vehicles (**KUROSHIO II**, **ARCHIMEDE**) the incentive is clearer: **KUROSHIO II** was built to specifically investigate a national food resource; **ARCHIMEDE's** purpose was to pursue deep-water scientific studies and to conduct recovery tasks of military significance. From the limited depth and specific tasks, such as recreation, instrument test platform and insurance claims, the impetus for construction seems almost personal. In some instances, however, it appears that a few larger corporations sensed a new market in the offing. One must remember that the time it takes for the idea to become reality in the submersible business can be considerable. So when a large, complex vehicle, such as **ALUMINAUT**, is launched in 1964, the influencing forces and decision to build predate launch by several years.

Fifteen years had passed since the end of WWII, and the written (14) and photographic accounts by Cousteau and his associates on the beauty of the sea and religious-like ambi-

ence of scuba diving, plus the commercial availability of relatively inexpensive diving gear, produced an annual invasion of the sea by newly-trained recreational divers at an ever-increasing rate.

Beginning in 1961 with the first **SPORTSMAN 300** and in 1963 with **SPORTSMAN 600**, both sometimes referred to as **AMER-SUB's** (15), the American Submarine Co. of Lorain, Ohio constructed shallow one- and two-man submersibles aimed at the recreational market (as their name implies) as well as government and other commercial activities. Various reports allude to 20 or more of this class having been constructed (16), but documentation is lacking.

A diving enthusiast himself, Florida newspaper publisher, John H. Perry, Jr., believed that a need existed for recreational submersibles to provide protection from sharks and other predators. In 1962 Perry manufactured his first successful "recreational" submersible (the third one built), the 150-ft, 1-man Perry **CUBMARINE** (at one point called **SUB ROSA**), later designated **PC3-X** (Fig. 3.10). But he soon abandoned the recreational goal and felt the market showed a need for industrial and scientific undersea "workboats;" to this end he produced the 600-ft, 2-man **PC-3B** in 1963. Perry advanced from a "backyard builder" hobbyist in 1950-1960 to a professional submarine builder—today the full-time producer of 12 submersibles of varying depths and capabilities and numerous diving capsules and several undersea habitats. In the process Perry Submarine Builders of Riviera Beach has become the largest single producer of manned submersibles in the world. But the impetus towards this production began with the assumed need for a recreational vehicle.

At Long Beach, California, the first "general utility" submersible (17) **SUBMARAY** appeared in 1962. The 2-man, 300-ft-depth vehicle laid claim to a wide range of capabilities: "Sea floor surveys, search and recovery, marine life studies, underwater photography, undersea research/development, inspection of pipeline, cables, etc." Mart Toggweiler was the first private owner to pursue the industrial and scientific undersea market and, at a lease cost of \$500 daily, his corporation, Hydrotech, subsequently reported 180 **SUB-MARAY** dives by the spring of 1964.

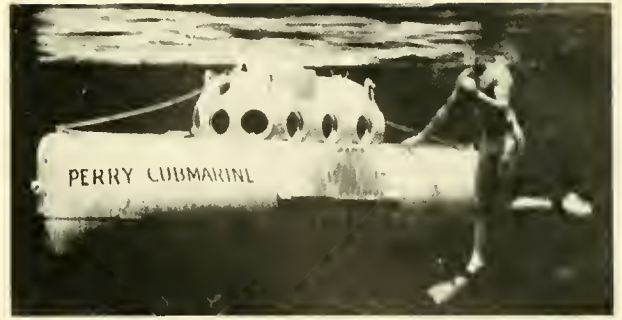

Fig. 3.10 PC3-X, the first of thirteen submersibles built by John Perry of Riviera Beach, Fla. (Perry Submarine Builders)

More modest capabilities went into the design of the first, and only, modern wooden-hulled submersible, **SUBMANAUT**, built in 1963 by oceanographer James R. Helle of San Diego. Unlike its earlier steel-hulled namesake, this **SUBMANAUT** was built of  $\frac{3}{4}$ -inch-thick, laminated plywood "Doughnuts" and had a design depth capability of 1,000 feet. The 2-man vehicle was to serve as a test platform for various electronic devices, e.g., pingers, communications systems, developed by Oceanic Enterprises, a division of Helle Engineering, Inc.

The same year saw the first, timid-like entry of large industry into the submersible field, for up to this point the participants were either federal governments or private individuals.

The nation's largest military submarine builder, General Dynamic's Electric Boat Division at Groton, Connecticut, put forth the first of its **STAR** (Submarine Test and Research Vehicle)-class vehicles, the 1-man, 200-ft-depth **STAR I**.

At this point it is interesting to note that a number of reports from NEL scientists had been published detailing the oceanographic discoveries and advantages of man *in situ*. The enthusiasm of the NEL oceanographers and their Naval officer associates was infectious and generated an optimistic future for manned underwater research and surveys. Significant, unique applications of manned submersibles were coming from a respected and highly qualified group of oceanographers and Naval officers (18); their influence was permeating the "new markets" forecasts of large American industry.

Indeed, just a year earlier (July 1962) Westinghouse Electric Corporation an-

nounced plans to build a 12,000-ft **DEEP-STAR** as a laboratory facility for its own undersea studies, and, if enough interest was shown, they would build further **DEEP-STARs** for lease or sale (19). For further reassurance Electric Boat had only to look in its own shops where the 51-ft-long, 12,000-ft-depth, 20-year dream-child of J. Louis Reynolds (20) was under construction. **ALUMINAUT**, an all aluminum submersible, was being built to conduct deep-ocean exploration into minerals and food resources and the salvage of sunken cargo vessels (21). As early as 1956 design studies at the Southwest Research Institute (22) had begun on **ALUMINAUT** and the idea was now becoming reality.

Meanwhile, oceanographers at Woods Hole Oceanographic Institution on Cape Cod were closely following the construction of the 6,000-ft, 3-man submersible **ALVIN**, being built at General Mills in Minneapolis. **ALVIN** (named after WHOI oceanographer Alyn Vine) was funded by the U.S. Navy's Office of Naval Research and, when completed, would come under the technical control and operation of WHOI. The Navy's interest in deep submergence was twofold: To demonstrate the feasibility of new construction techniques, materials and subsystems for possible application to future military submarines; and to provide civilian and military oceanographers with a vehicle from which they, like their NEL counterparts, could conduct oceanographic studies applicable to both military and civil requirements. At an estimated \$1 million, **ALVIN** would be a relatively inexpensive test platform considering the \$180 million plus cost of the then modern-day nuclear attack submarines. In addition, while the materials/components testing was in progress, an equally important set of environmental data would be obtained.

To add further promise of a burgeoning undersea market, in April 1963 the U.S. Department of the Interior asked Congress for funds to perform a feasibility study on a nuclear-powered research submarine or mesoscaph to conduct a wide range of biological and geological studies (23). Explaining the need for such funds, the then Secretary of the Interior, Stewart Udall, stated:

*"We need better eyes in the sea; eyes*



Fig. 3.11 General Dynamics' **STAR I** simulates rescue of personnel at 192 feet off Bermuda. (Gen. Dyn. Corp.)

*comparable in power to those with which scientists are probing outer space. We need to apply our technological abilities to more intensive probing of inner space, the world ocean."*

With such promising indications did Electric Boat launch its **STAR I** (Fig. 3.11) for the expressed purpose of more clearly defining the problems inherent in underwater engineering: Materials, structural and hydrodynamic design, instrumentation, buoyancy, navigation, control communications and life support.

For related purposes, the Data and Controls Division of Lear Siegler, Inc., launched their 600-ft, 2-man **BENTHOS V** as a test vehicle for subsystems, particularly in the area of propulsion.

Into this atmosphere of cautious and hopeful anticipation, a tragedy arrived which brought the field of deep submergence to a fever pitch. On 10 April 1963 the nuclear

attack submarine **THRESHER** (SSN-593) (Fig. 3.12) disappeared in 8,400 feet of water off the coast of New England and carried 129 men to their death. A Navy task force was immediately fielded to locate the wreckage and attempt to determine the cause of the sinking. In addition to a variety of devices to search the general area—such as towed cameras and magnetic sensors—the searchers also desired to place men on the scene. At this time **TRIESTE** constituted the only U.S. capability for reaching 8,400 feet.

**TRIESTE**'s performance in 1963 and a year later was less than admirable: Too slow towing (2–3 knots); too slow submerged (0.9 knot); awkward to maneuver; surface pre- and post-dive preparations could not be performed when seas greater than 3 to 4 feet high prevailed; in short, the bathyscaph was simply not able to put the time on the bottom required for searching (24). Even with an interim overhaul, from which a newly designated **TRIESTE II** emerged with a new float designed for faster towing (Fig. 3.13) and greater propulsive power and a manipulator, it wasn't much better than an elevator, and an unreliable one at that.

Two weeks after **THRESHER** met its doom, the Secretary of the Navy set up a Deep Submergence Systems Review Group which conducted a year-long study on deep-oceans operations, not only for **THRESHER**-type search missions, but for recovery of missile and space components as well. In June 1964 the DSSRG released its report. Four main categories were addressed: 1) Recovery (rescue of personnel); 2) man-in-the-

sea; 3) investigation of the ocean bottom and recovery of small objects, and 4) recovery of large objects. The total amount recommended for a 5-year program to meet the group's stated objectives was \$333 million. Specifically, the recommendations of interest to submersible builders called for the following:

**Recovery of Personnel:** Six rescue units with two submersibles in each unit capable of rescuing personnel from the collapse depth of current submarines (at a later date a depth of 5,000 ft was established).

**Recovery of Small Objects and Ocean Floor Investigation:** Two search units of two small submersibles each with an ultimate depth capability of 20,000 feet.

**Recovery of Large Objects:** An unspecified number of small submersibles capable of supporting recovery of intact submarines down to collapse depth.

The recommendations were accepted in June 1964 and a Deep Submergence System Project was established to execute them. The following November a meeting was held in Washington, D.C., where the DSSP was described and areas of technological concern delineated. Eight hundred industry representatives attended; 1,000 were unable to attend owing to lack of space (25). The absolute finality of sudden, violent death, the lack of knowledge as to why and the possibility of nuclear contamination, of which no evidence could be found (24), produced a reaction never before witnessed in the wake of a submarine tragedy.

With increasing attention focusing on the deep sea, new submersibles joined the fledgling 1964 community. The 100-ft **NAUTILETTE** continued to pursue the recreational field, but John Perry's **PC-3A1**, a 300-ft, 2-man submersible, went to the U.S. Army for a new type mission: Recovery of missile components in the down-range islands of the South Pacific. Its sister-sub, **PC-3A2**, went to the Air Force for similar tasks.

At the Naval Ordnance Test Station, China Lake, California, the 2,000-ft, 2-man **DEEP JEEP** was launched. **DEEP JEEP**, under construction since 1961, was built primarily to evaluate various design systems and operational techniques anticipated for a general-purpose oceanographic and work submers-



Fig. 3.12 The USS **THRESHER** which sank in 1962 and carried 129 men to their deaths. (U.S. Navy)

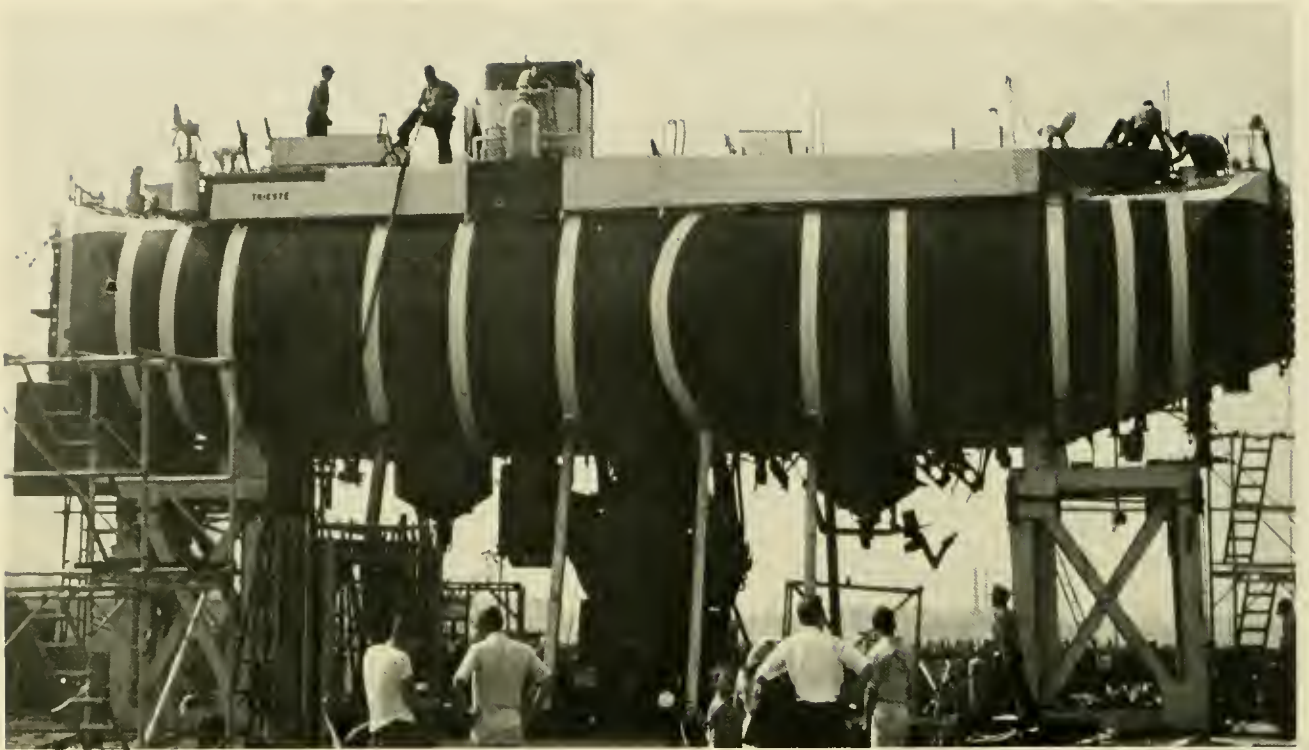

Fig. 3.13 The evolution of *TRIESTE* 1958 (date approximate). (U.S. Navy)

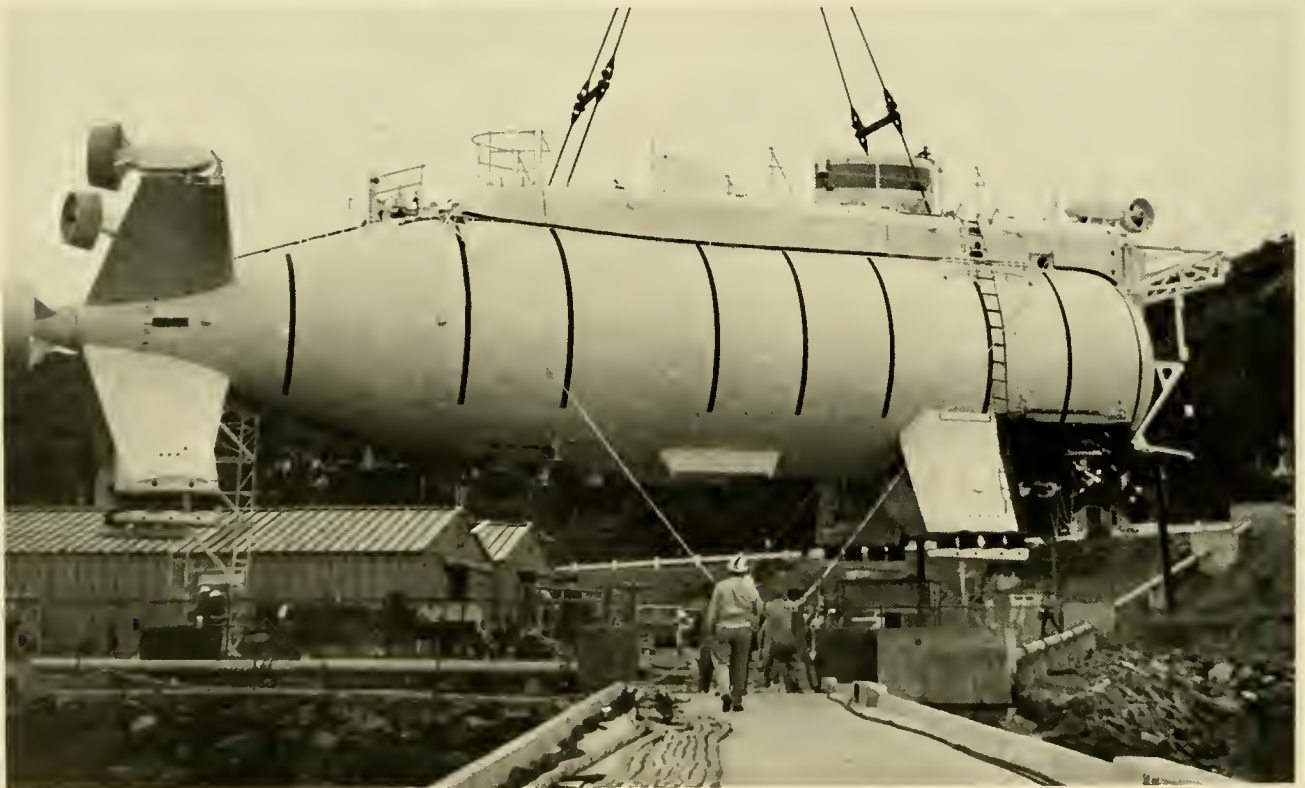

Fig 3.13 *TRIESTE*—1964. (U.S. Navy)

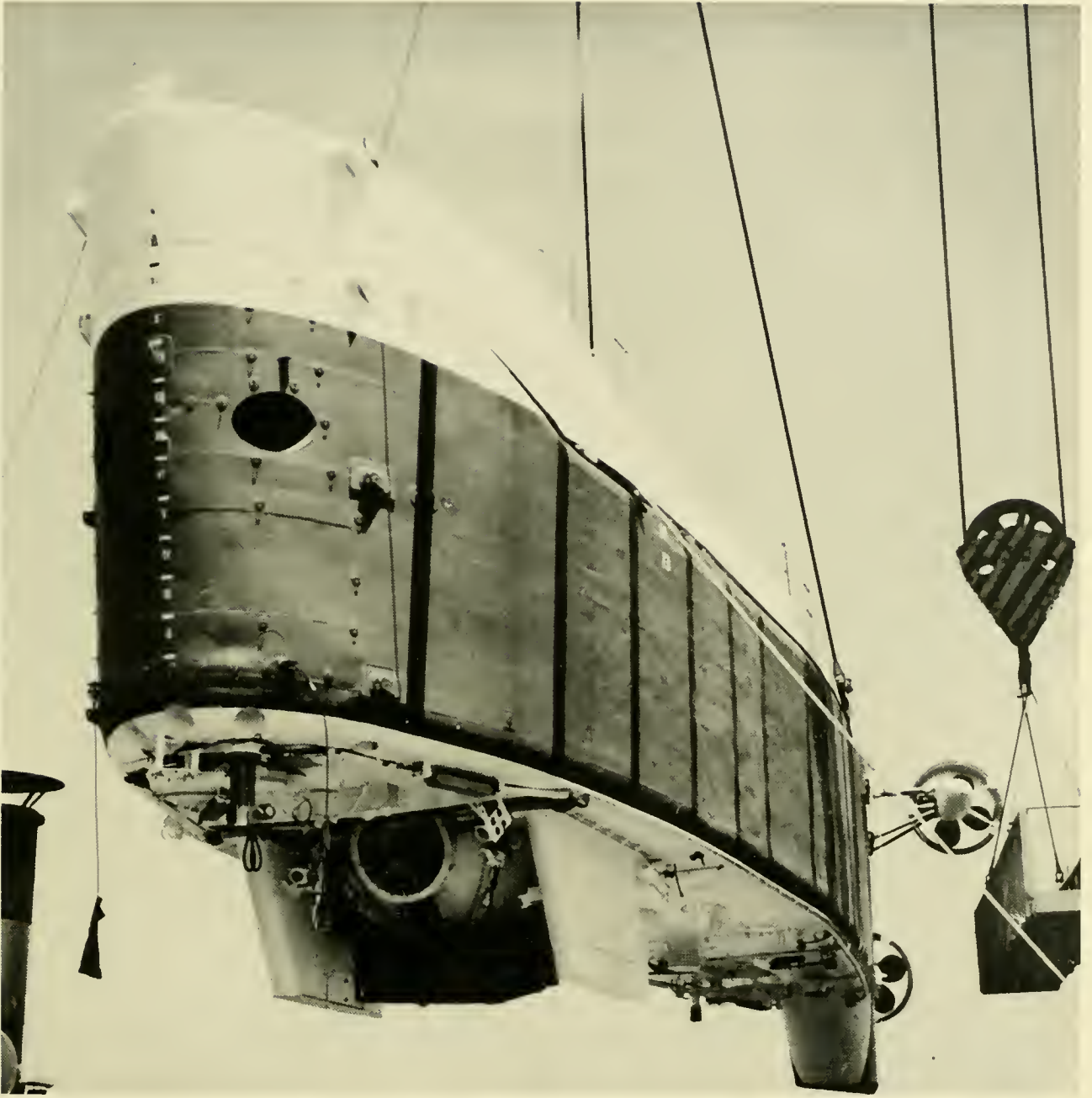

Fig 3.13 TRIESTE 1958 (U.S. Navy)

ible in underwater test ranges (26). Several subsequent U.S. Navy submersibles (*HIKINO*, *NEMO*, *MAKAKAI*, *DEEP VIEW*) were built for purposes similar to *DEEP JEEP*, *i.e.*, to test and evaluate systems and materials rather than serve in an operational capacity.

In Woods Hole, *ALVIN* was launched and began testing for a career that would be

exceeded by none for contributions to undersea technology and science. The 15,000-ft *ALUMINAUT* (Fig. 3.14) rolled off the ways at Groton to play:

*“ . . . a key role in man’s efforts to farm the sea, mine it and harness its energies.”*

—J. Louis Reynolds (27)

Two other submersibles appeared in 1964 for reasons different than any so far. **ASHERAH**, a 2-man, 600-ft vehicle (Fig. 3.15), was built by General Dynamics for the University of Pennsylvania Museum with grants from the National Geographic Society and the National Science Foundation. Named after the Phoenician sea goddess, **ASHERAH** would play a major part in mapping ancient Mediterranean shipwreck sites under the direction of archeologist George Bass. **AUGUSTE PICCARD** (Fig. 3.16), named after the now deceased father of deep submergence, was designed by Jacques Piccard and constructed by Giovanola of Switzerland. The 93-ft-long, 2,500-ft-depth submersible was stationed on Lake Geneva (Leman) and conducted daily dives wherein 40 passengers, each with his own viewport, cruised the bottom of the 1,000-ft-deep lake. **AUGUSTE PICCARD** was financed by the Swiss National Exposition as a tourist attraction; from 16 July 1964 to 17 October 1965 it conducted 1,112 dives and introduced over 32,000 passengers to the field of limnology.

That a market for submersibles did, in fact, exist was demonstrated in 1964 and early 1965. Under an arrangement with Cousteau's OFRS, Westinghouse Corporation's world-wide charter facility brought the **DIVING SAUCER** to California where it carried

scientists and engineers from government and academia on a total of 132 dives during January–March 1964 and November 1964–April 1965. Working primarily in the canyons off Southern California, the **DIVING SAUCER** produced an impressive array of *in situ* oceanographic data and photographic documentation. The uniqueness of deep diving and its inherent drama received a great deal of attention from the media and trade journals and served as a further catalyst drawing attention to hydrospace. The **DIVING SAUCER** operations were the first long-term, open-ocean series of dives where industry provided the submersible system as a facility for diving scientists.

### OCEANOGRAPHIC CLIMATE OF THE MID-SIXTIES

Based on the accelerated development of submersibles from 1965 to the present (1975), one must conclude that somewhere between 1963 and 1966 the undersea climate brought many companies to the decision to build. Let us examine, from the decision-maker's point of view, the atmosphere which influenced his thoughts in 1965.

**TRIESTE's** record dive to the greatest known ocean depth and the twenty or so follow-on second generation submersibles were obvious proof that no major break-



Fig. 3.14 Reynold's **ALUMINAUT** underway to sea trials off Connecticut in 1964 (Gen. Dyn. Corp.)





Fig. 3.15 ASHERAH is christened to begin its life as an underwater archeologist for the Univ. of Pennsylvania. (Gen. Dyn. Corp.)

throughs in technology were required to build a safe and satisfactory submersible.

The Navy's interest in submersibles was more than casual: It now owned three (*TRISTE*, *ALVIN*, *DEEP JEEP*) and was launched into the multi-million dollar DSSP. The DSSP was not the only likely candidate for submersible services and sales. Proposals were circulating amongst various government activities outlining the need for at least one and, in several cases, two submersibles in Navy test ranges as workboats for repair, salvage and other duties. In fact, specifications were being prepared in 1965 for construction of two *ALVIN*-like submersibles called *AUTEC I* and *II* for the Atlantic Undersea Test and Evaluation Center, in the Tongue of the Ocean, Bahamas. One of the best recommendations one can forward in replying to a government Request For Proposals is a demonstrated capability. When such RFP's began appearing it would, so the thinking went, be a strong selling point to

offer a submersible with a successful track record as a demonstrated capability.

Would the funds be forthcoming? By 1965 the Federal government had already invested \$26 billion in a dramatic, daring and exciting space program; why not the sea? It was equally dramatic, mysterious and excit-

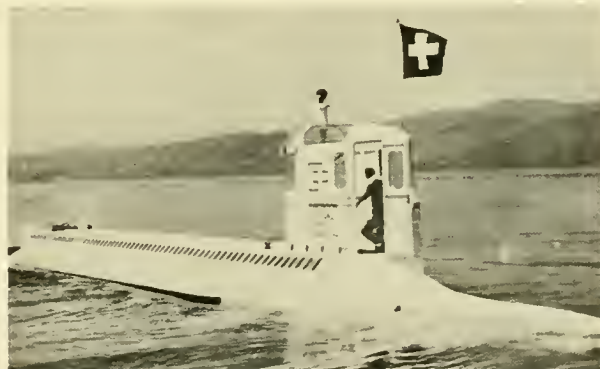

Fig. 3.16 Now a Canadian survey submersible, *AUGUSTE PICCARD* began its career carrying 32,000 people to the bottom of Lake Geneva in 1964 and 1965. (Swiss Expo.)

ing. Besides, strong arguments could be advanced for pushing back the frontiers of hydrospace with its inherent food and mineral resources. That the Federal government was paying more than lip service to the ocean could be seen in the funds allocated for support of oceanography. One conservative estimate (28) shows Federal funds of \$21.3 million devoted to oceanography in the year 1958. In 1963 the annual amount was six times that, or \$123.6 million. These figures reflect funding concerned only with describing and understanding the oceans. If funds are included which reflect development of fisheries, technology, coastal zone development, mapping, charting, ocean engineering and other ocean-related activities, these annual figures are almost doubled. For example, reference (29) shows \$227.6 million in 1968; reference (30), which includes all ocean-related activities, shows \$431 million for the same year. From 1958 to 1965 the funding growth of oceanography was, no matter how calculated, phenomenal.

The Federal government was not the only prospective customer. Just off the shoreline and expanding outward and deeper was the oil industry. For years the diver had been a full-time employee of the marine petroleum community providing repairs, inspection and installation of various devices and hardware associated with exploration, development and production of offshore oil. Submersibles could go deeper, stay down longer, and the passengers need do no more than look out the viewport. Certainly a market could be found in this multi-billion dollar industry.

Adding further enchantment was the tremendous surge in recreational diving. With interest running high, there must be a market somewhere for small, inexpensive recreational submersibles; the tourist concept of the *AUGUSTE PICCARD* was given more than a passing glance. If 32,000 people were willing to pay for a trip to the relatively uninteresting bottom of Lake Geneva, it is not unlikely that a continuing and even larger number would pay for shallower, but far more interesting cruises through the incredibly beautiful coral reefs of the Bahamas or Florida.

When one inspected the existing submersibles in 1965 they all were employed to a

greater or lesser degree. Those that were not, were hurriedly going through testing phases and acceptance trials. *DIVING SAUCER* just finished a lease on the West Coast; *ASHERAH* was conducting biological surveys in Hawaii; *AUGUSTE PICCARD* was making an average of nine dives a day at the Swiss Exposition; the government-owned vehicles were either diving or testing; and the smaller vehicles (*PC-3B*, *SUBMARAY*) were being kept busy. Another new customer was introduced in June 1965 when the U.S. Naval Oceanographic Office chartered the *PC-3B* for a series of cable route surveys off the coast of Andros Island, Bahamas. This was not the Oceanographic Office's only involvement in submersibles. In the same year it received its first funds for a research and development program aimed at evolving design specifications, instrumentation and operational techniques for a 20,000-ft Deep Ocean Survey Vehicle. In the process, its announced intention was to lease existing vehicles and use them in actual surveys to get a feeling for the problems involved in undersea surveying; over \$1 million a year for the next 5 years was scheduled for submersible leases.

If the potential submersible builder needed further encouragement he could find it from government officials, the press and his own associates; for example:

*"The President (Johnson) announced today that the Department of the Navy and the Atomic Energy Commission are jointly developing a nuclear-powered deep submergence research and engineering vehicle."*

—White House Press Release  
April 1965

*". . . the field (deep submergence) is a new one and the future rewards for any company which can successfully build a vehicle capable of working safely, effectively and for a proper length of time on the bottom of the ocean will be great."*

—VADM I. J. Galatin  
Chief of Naval Material  
May 1965 (26)

*". . . in response to the growing demand for both government and industry the*

*nation's naval architects are producing a fleet of small, odd-looking submarines, most of these aimed at great depths."*

—*TIME*

5 June 1965

*"We're about where the space industry was ten years ago. My guess is that this new industry will be larger than aerospace."*

—G. T. Scharffenberger

Senior V. Pres., Litton Ind.

*NEWSWEEK*

27 September 1965

*"Despite the recent appearance of more non-military submersibles the shortage still exists."*

—R. Loughman,

General Dynamics Corp.

—G. Butenkoff,

Allis Chalmers Mfg. Co.

September 1965 (29)

There was yet another factor impossible to assess: the magnetic attraction of man to the deep ocean. The opportunity to be on the very frontiers of abyssal exploration is powerful tonic. The attraction of things beneath the sea is apparent considering the television and cinematic successes of Cousteau and others. The foundations of this attraction lay in the unknown, the beauty, the eternity, the serenity and the brutality of life beneath the waves. To the layman, it is a spectator's world; to the average oceanographer and marine engineer of the pre-1960's it was a world of inference. Before Beebe, all knowledge of the ocean below 100 or so feet was derived from instruments hung over the side of ships. From such discrete bits of data did oceanographers infer the condition of the deep. When scientists and engineers, who spent years on rolling, pitching ships trying to piece together what lay beneath their decks, sense the opportunity to see this realm with their very eyes, decisions can be made which transcend profit-and-loss statements. Whether large or small, corporations are groups of individuals, and the attraction of the deep ocean is no less to the engineers or vice presidents of General Motors or

North American Rockwell than it is to a Piccard or a Perry. To an immeasurable, but significant degree, this magnetic attraction drew the decision-makers of the mid-sixties.

## VEHICLES FOR ANY OCCASION (1965–1970)

Succumbing to the prevailing atmosphere, submersible builders in the last 5 years of the 1960's produced the greatest variety of deep-sea participants and activities in history and, almost overnight, saw the sharpest decline. From 19 operational vehicles in 1964, the number grew to 60 by the end of 1970. Federal support of oceanography, increasing by leaps and bounds in the early sixties, leveled off in the latter part of the decade, and with it the submersibles of large industry either went into storage or were sold. The largest user of submersibles in the U.S., the Navy, acquired its own vehicles and discontinued leasing. Trends in vehicle design developed which resulted in greater viewing capability, diver support and transport, greater manipulative capacity and a lessening emphasis on great depth capability.

Indeed, developments and shifting trends in undersea technology occurred with such rapidity in this period that it must be followed on a year-to-year basis to comprehend.

### 1965

Under an agreement with Cousteau's OFRS, Westinghouse Corp. anticipated the delivery of a 12,000-ft **DEEPSTAR** vehicle in 1964, but welding problems developed in the Vasco Jet-90 steel hemispheres. The attendant delay and possibility of Navy certification problems was unacceptable to Westinghouse. Instead, they constructed a sphere of HY-80 steel, used by the U.S. Navy in nuclear submarines, and, accepting a depth decrease of 8,000 feet, fitted it to the already designed **DEEPSTAR**. The Vasco Jet hull remained in France and would later (1970) constitute the pressure sphere of **SP-3000** (31). The new **DEEPSTAR 4000** began its test dives at San Diego in early 1966.

In Vancouver, British Columbia three commercial divers completed the first of their

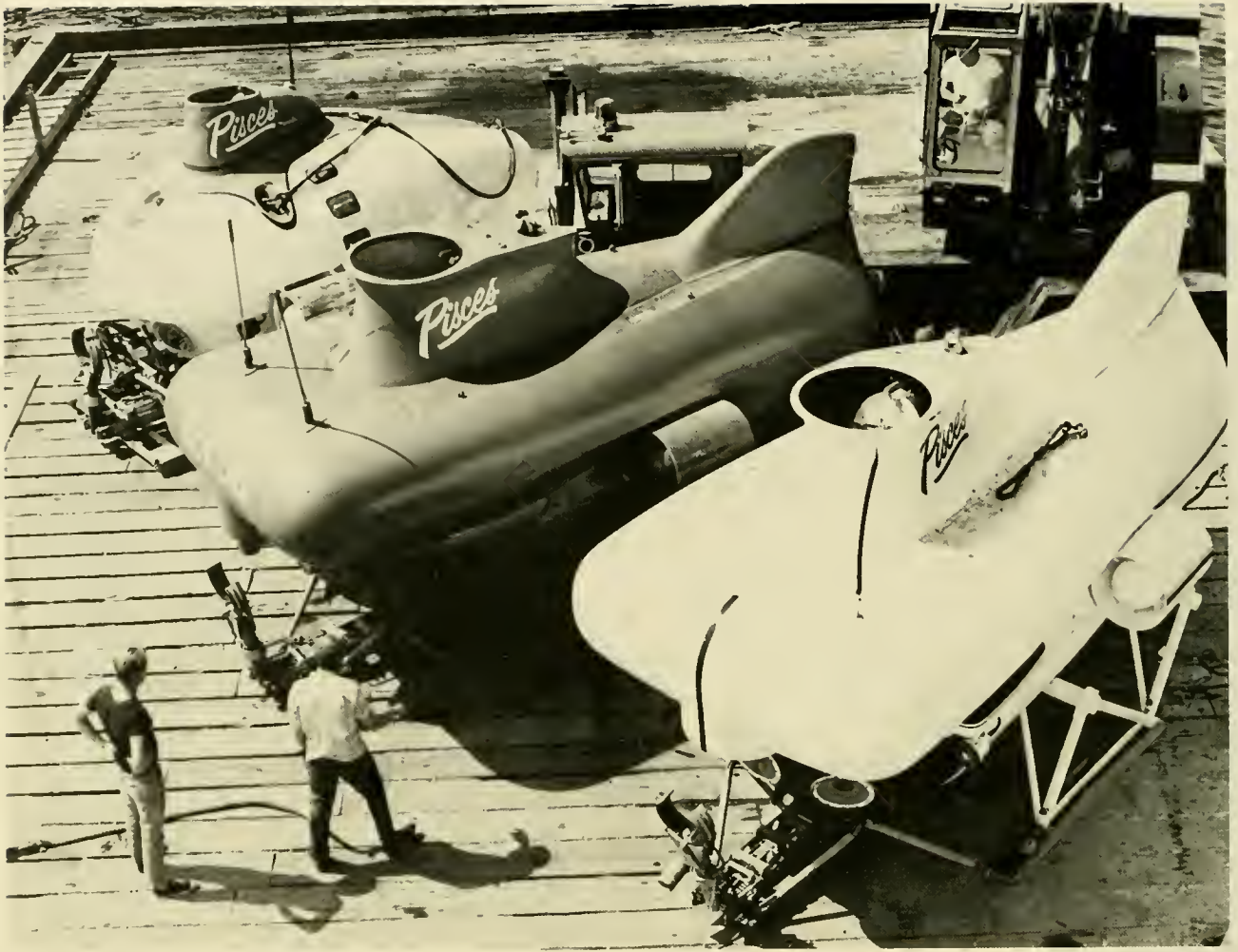

Fig. 3.17 PISCES I, II and III (L to R). Workhorses of the Arctic and North Sea (International Hydrodynamics)

**PISCES**-class vehicles. **PISCES I** (Fig. 3.17), a 1,200-ft, 3-man submersible, was constructed by International Hydrodynamics Ltd. (HYCO) “. . . to provide a quantum jump in man’s ability to work undersea.” Reasoning that a submersible offered greater depth, duration and exploration ranges, the partners of HYCO also saw the opportunity to allow the non-diving specialist of any discipline to visit subsurface work-sites under “shirt sleeve” conditions. A total of seven submersibles and hundreds of dives would come out of this small, vigorous Canadian firm in the next 8 years.

### 1966

The role of manned submersibles in under-sea search efforts was given a strong boost in February 1966 when an American bomber

collided with its tanker during mid-air refueling off the southern coast of Spain. Four of the aircraft’s H-bombs fell harmlessly on land and were recovered; one fell into the sea and initiated another **THRESHER**-type operation to find and retrieve the errant, 1.1-megaton bomb. The bottom of the ocean at 2,200 to 3,000 feet off Spain is characterized by deep gullies running downslope at a steep gradient; shoreward of 2,250 feet it is more level and gentle. The precise location of the bomb was unknown, and it could be anywhere from a few feet deep adjacent to the coast, to several thousand feet some miles off the coast. Virtually every applicable search/identification device the Navy owned or industry could offer was brought into play: Mine hunting sonar, side scan sonar, underwater television, divers and manned sub-



Fig. 3.18 Explosive experts examine the parachute-fouled H-Bomb recovered from 2,850 feet off the Southern Coast of Spain in 1966. (U.S. Navy)

mersibles. The sonar devices worked well in flat, nearshore areas, but they could only tell that "something" was on the bottom, not what it was. Ambient pressure divers did most of the shallow identification along with the Perry *PC-3B*. In the rugged, offshore bottom the bomb was concealed from sonar contact by ridges between the gullies. The offshore search was left to *ALVIN*, *ALUMINAUT* and *DEEP JEEP*. The latter ran into operational difficulties and withdrew early in the search. *ALVIN* located the parachute-shrouded bomb at 2,250 feet and attached a lift line which parted during retrieval and started the search anew. When the bomb was relocated it was now at 2,850 feet, and a self-propelled, TV-equipped, cable-powered device, *CURV* (Controlled Underwater Research Vehicle), was employed to attach a lift line for retrieval. In the process of hooking up, *CURV* became entangled in the bomb's parachute and fortuitously both *CURV* and the bomb were retrieved (Fig. 3.18) after some 80 days of search/recovery efforts.

While the performance of all system participants was less than perfect, the bomb was found and recovered, an almost impossible feat at the time of *THRESHER* 3 years earlier. The bomb hunt highlighted the problem of undersea navigation, reliability of submersibles and the still primitive stage of our ability to recover objects from the deep sea (32). The bomb hunt, with its attendant publicity, provided more encouragement to the submersible builders. *ALUMINAUT*'s \$304,000 bill for its participation did not go unnoticed either.

In June 1966 Westinghouse Corporation's *DEEPSTAR 4000* (Fig. 3.19) began a diving program for NEL that continued into the spring of 1968 and covered not only the east and west coasts of the U.S., but Central America as well. Including a Westinghouse-financed series of 11 dives in project GULFVIEW in the Gulf of Mexico (33), *DEEPSTAR 4000* conducted some 500 dives from June 1966 through June 1968. It is significant that this contract would be the longest Navy lease given to any privately-owned submersible to the date of this publication; the total contract amounted to \$2,142,155 (34).

Another aspect of submersible diving which entered the 1966 scene was that of



Fig. 3.19 Originally slated for 12,000 feet, *DEEPSTAR 4000* represented the first Westinghouse candidate for deep diving. In its 4-year career the versatile craft would conduct over 500 dives and add significantly to our knowledge of the deep sea. (NAVOCEANO)



Fig. 3.20 General Dynamic's 1966 entries into Deep Submergence: STAR II and III. (Gen. Dyn. Corp.)

certification. Prior to 1966 Naval military and civilian employees could officially dive in privately-owned vehicles with no more than the permission of their superiors. In 1966 the Navy instituted procedures for certifying submersibles to assure that they were materially safe to dive. Instructions were later issued to certify the operators and the nature of the mission as well. **DEEPSTAR 4000** was the first commercial vehicle to become Navy-certified. To July 1969 all other commercial submersibles were granted certification waivers. Other government non-Navy activities, academia and industry had no such requirements until some adopted the American Bureau of Shipping's standards in 1968.

ABS does not certify, instead it classifies submersibles to conduct a specific task, such as transportation or research. The Navy's certification, on the other hand, is for certain depths and stated time periods and is only concerned with safety of the passengers. ABS classification is completely voluntary and need not be undergone if the lessee does not make it a requirement. Indeed, the only Federal regulations governing submersible operations then and now are the Coast Guard's regulations applying to small craft. Certification and regulations are dealt with in more detail in a later chapter. It is sufficient to note here that many small-submers-

ible operators feared that the Navy's certification procedures, which require a great deal of expensive testing and documentation, would be adopted by the government generally. Of nine bills introduced to Congress regarding submersible safety since 1968, none have become law.

Further entries to the 1966 submersible fleet came from General Dynamics Corporation in the form of the 1,200-ft **STAR II** and the 2,000-ft **STAR III** (Fig. 3.20).

#### 1967

*“Unless more small submersibles are built in the near future, the demand for these craft may exceed the supply.”*

—National Council on Marine  
Research & Engineering  
February 1967 Development Report

To fill this demand, Lockheed Missiles and Space Division launched its sophisticated, 8,000-ft, 4-man **DEEP QUEST**. Lockheed was the first submersible builder to construct a support ship/launch-retrieval system specifically designed for its submersible, and **DEEP QUEST** included virtually every type of control and maneuvering capability one could envision for submersible missions. In addition to research, engineering or survey tasks, the 40-ft-long vehicle could be fitted with a transfer skirt on the bottom of its aft



Fig. 3.21 Although its early career was short-lived, *PAULO I* began diving in earnest in 1973 as the renovated *SEA OTTER*. (Anautics Inc.)

pressure sphere to effect rescue of trapped submariners; in essence, it was the first industry DSRV and clearly demonstrated Lockheed's expertise in deep submergence.

Down the coastline from Lockheed's Sunnyvale plant, another submersible, *PAULO I*, was launched (Fig. 3.21). Built by Anautics Inc. of San Diego, the 600-ft, 2-man submersible was designed for inspection, survey and recovery on the continental shelf.

Beginning in 1967, Captain G. W. Kirtledge, USN (Ret.), constructed the first of several 1-man, 250-ft submersibles known as the *VAST* or *K-250* series (15). The submersible was advertised for application to a wide variety of tasks, and an acrylic plastic dome on the conning tower and a 16-inch-diameter forward viewport provided versatility of viewing from the 10.5-ft-long submersible.

Acrylic plastic was tested for the first time as a candidate for pressure hulls. Built in the latter part of 1966, plastic-hulled *HIKINO* (Fig. 3.22) underwent tests by the Naval Weapons Center at Shaver Lake, California in early 1967. Several new concepts were embodied in *HIKINO*: An acrylic plastic pressure sphere to provide panoramic viewing; cycloidal propellers for maximum maneuverability with a minimum amount of propulsion units; and a catamaran-type chassis or exostructure for maximum surface seaworthiness and unhindered visibility (35). *HIKINO* was purely a test vehicle, but it was a harbinger of things to come. One paramount criticism of submersibles was the re-

striction on viewing. No matter how many viewports a vehicle may have, from the standpoint of safety and operational effectiveness, more seemed desirable. The concept of an acrylic plastic pressure sphere had been advanced as early as 1963 (36), but this was the first instance of its application. The wider range of viewing through transparent hulls and large diameter bow domes, pioneered by *HIKINO*, would see increased application in shallow submersibles of the 70's.

### 1968

If there was, in fact, a shortage of submersibles in 1967, it vanished in 1968 with the advent of 12 new vehicles.

*NEKTON ALPHA*, a 1,000-ft, 2-man submersible built by General Oceanographics of Newport Beach, California, originally began its career as an in-house capability of this company to conduct contract jobs of its own. Another 1,000-ft, 2-man vehicle *SEA-RAY* (*SRD-101*) was built in this year by Submarine Research and Development Corp., in Lynnwood, Washington for inspection and salvage tasks at \$1,200 per day.

International Hydrodynamics Ltd., enjoying an extended torpedo-retrieval contract for the U.S. Navy in a test range off Nanaimo, British Columbia, extended its depth capability with the 2,600-ft *PISCES II*.

Perry Submarine Builders produced three submersibles; the first, the 3-man, 1,200-ft *PC5* went to Pacific Submersibles, Inc., of Honolulu; the second two were unique. The

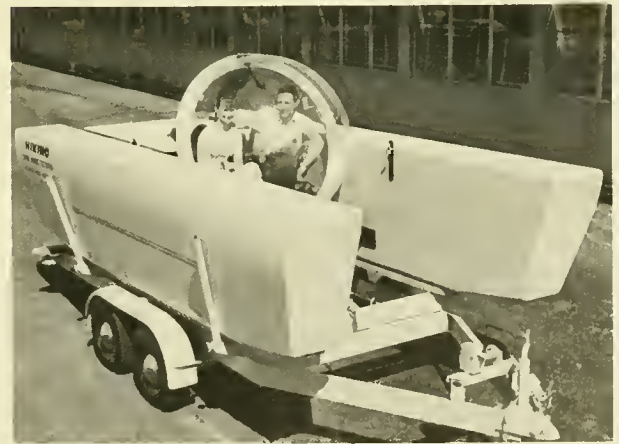

Fig. 3.22 The plastic-hulled *HIKINO* set an early precedent for submersibles of the seventies. (U.S. Navy)

1,350-ft **DEEP DIVER** (Fig. 3.23) and the 800-ft **SHELF DIVER** were a new breed called “lock-out” submersibles. In both vehicles the after portion of the pressure hull was a sphere in which the pressure could be brought to ambient and a hatch in the bottom opened to allow egress of divers. While not a new concept, it was the first such design of this period and was addressed primarily toward support of divers in the petroleum industry. Demonstrating the versatility of this concept to support not only divers, but also to effect “dry” transfer of materials and non-divers to an atmospheric-pressure undersea habitat, **SHELF DIVER** locked onto Perry’s **HYDROLAB** at the 50-ft depth in 1968 and transferred crewmen into the habitat without them getting wet.

On the west coast of the United States, North American Rockwell Corp. introduced their **BEAVER MK IV**, another “lock-out” submersible of 2,000-ft-depth capacity. **BEAVER**’s sophisticated instruments and subsystems provided a wide array of capabilities in all aspects of undersea tasks. Particularly innovative were its two mechanical arms and accessories which advanced the state-of-the-art in manipulative capability by a wide margin.

Also on the west coast, General Motors Corporation’s Defense Research Laboratories at Goleta, California, launched the 6,500-ft, 3-man **DOWB** (Deep Ocean Work Boat). Instead of viewports, **DOWB** (Fig. 3.24) relied upon optical systems for viewing; two 180-degree-coverage optical domes were in-



Fig. 3.23 The Perry-Link **DEEP DIVER** was the first modern submersible to incorporate a diver lock-out feature. (Ocean Systems Inc.)





Fig. 3 24 Now a student training aid, *DOWB* was the only submersible to relinquish viewports in favor of fiber-optics. (Gen. Motors Inc.)

stalled; one looked forward and one downward. Separate images for two observers were provided inside through a central optical assembly.

In December, the U.S. Navy added to its Fleet the 6,500-ft, 3-man sister submersibles *SEA CLIFF* and *TURTLE* (originally *AUTEC I & II*) built by General Dynamics (Fig. 3.25); *TURTLE* was slated for assignment to the Navy's *AUTEC* in the Bahamas, and *SEA CLIFF* was to be assigned to Woods Hole Oceanographic Institution (37), though WHOI later declined the offer.

Under contract to the Grumman Corporation of Bethpage, New York, Jacques Piccard designed and Giovanola Brothers built the 48-ft-long, 2,000-ft *PX-15* in Monthey, Switzerland (Fig. 3.26). Capable of 4- to 6-week duration dives, *PX-15* (later christened *BEN FRANKLIN*) was foreseen by Grumman to fill a needed gap for extended missions which submersibles at that date could not perform (38). For its first mission *BEN FRANKLIN* would perform a 30-day drift in the Gulf Stream relying on the current for propulsion

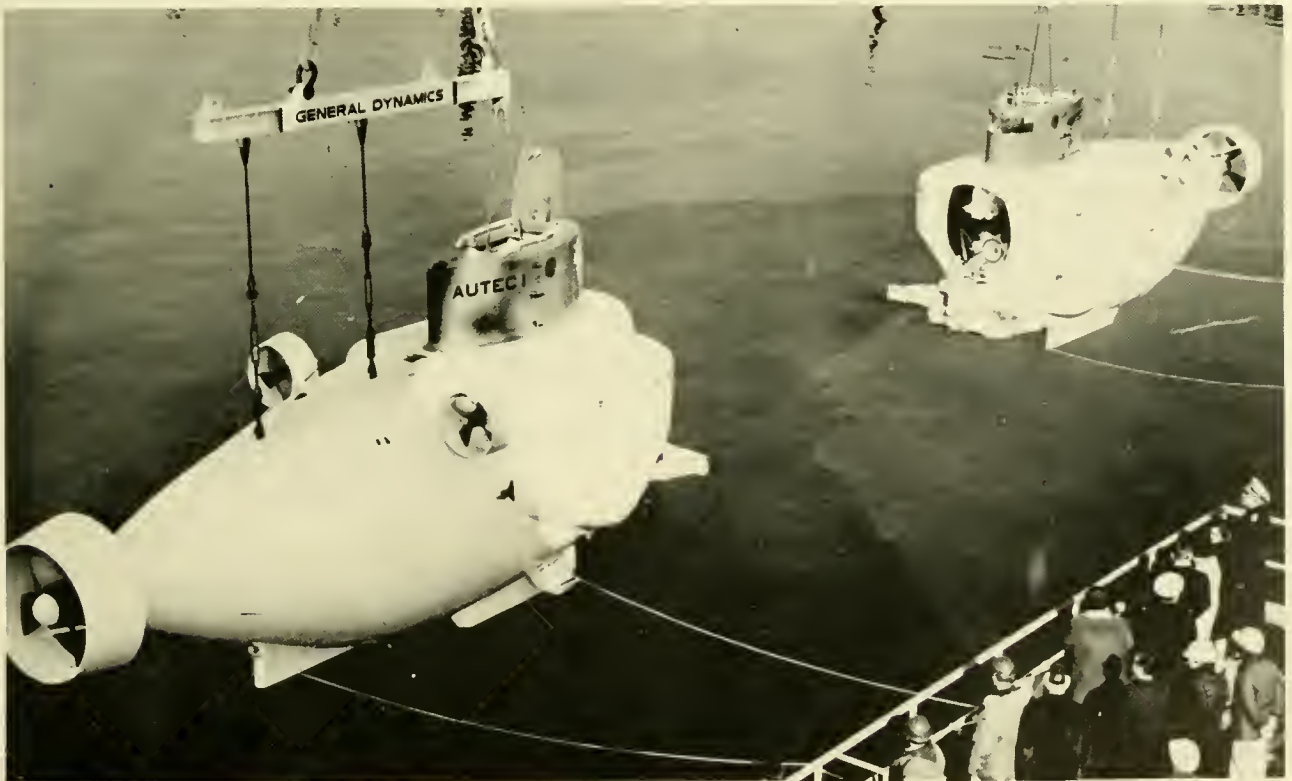

Fig. 3 25 Earmarked for work boats in the U.S. Navy's Bahamian Test Range, *AUTEC I* and *II* were redesignated *SEA CLIFF* and *TURTLE* and ultimately came under Submarine Development Group-One in San Diego (U.S. Navy)

and a liquid oxygen-passive carbon dioxide removal system for life support. **BEN FRANKLIN** was transported to West Palm Beach, Florida in 1968 for sea trials preparatory to the Gulf Stream Drift Mission.

In the midst of the increasing undersea tempo prospects for the future were taking a disquieting turn. At an April 1968 Annual Conference of the American Society of Oceanography in Los Angeles, California, Mr. Thomas Horton, former Marketing Director of Westinghouse's **DEEPSTAR 4000**, presented some chilling news to potential submersible lessors (39). Alluding to the dependence of the Navy submersibles now operating on Navy Research and Development programs, Horton foresaw a dire future in light of the R&D funding cutbacks of the past few years. He pointed out that indus-

try's investment in submersibles was far out of proportion to the market, and what market was left would experience energetic competition, with the weaker companies falling by the wayside.

Furthermore, Horton revealed, it was doubtful if any leasing programs to date were profitable. He stated that Westinghouse's 6-month lease of the **DIVING SAUCER** was *not* profitable, and surmised that International Hydrodynamics, Perry, and Electric Boat, among others, had the same experience: Profit on sales and loss on leasing operations. Horton projected that this may be due to a lack of capabilities and pointed out ". . . sophisticated as they (submersibles) may seem, their ability to do economically justifiable tasks in the sea is very unsophisticated."

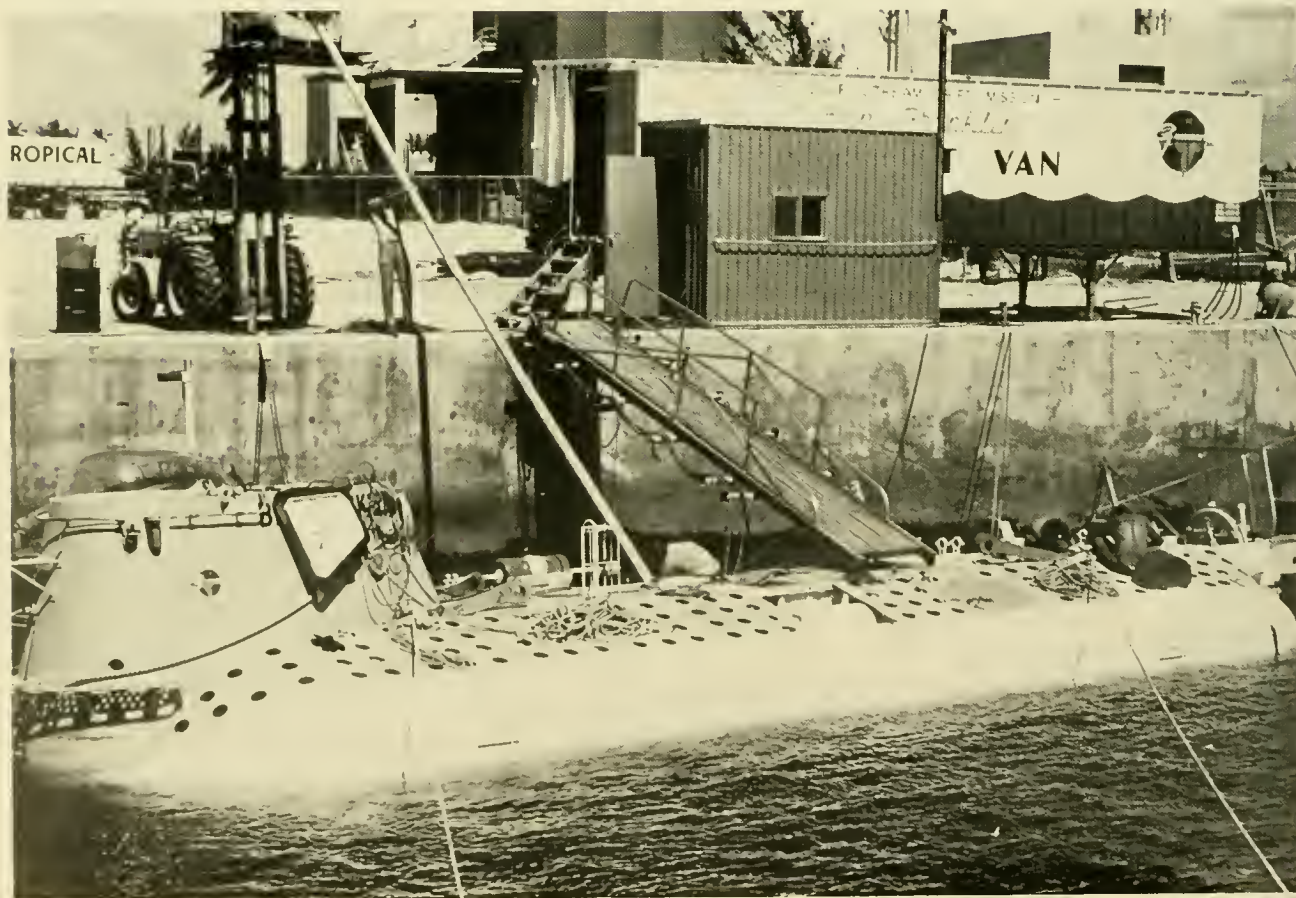

Fig 3.26 On 14 July 1969 **BEN FRANKLIN** began a 30-day drift off West Palm Beach, Fla. that carried its crew of six 1,500 miles before they left the 49-ft-long submersible. (NAVOCEANO)

With some experience behind them, submersible owners were now in a better position to assess their potential profits; the outlook was not encouraging. To maintain a submersible and its support ship on standby is expensive. A small vehicle such as *SEA OTTER* requires some \$80,000 to \$100,000 of business annually to make a reasonable profit (40). A mid-depth submersible of the *ALVIN*-class requires between \$700,000 to \$800,000, and *ALVIN* operates for a non-profit institution. It was becoming clear: Submersibles were expensive, and the long-term contracts required to operate in the black were less and less a prospect.

In August 1968 a near-tragic event occurred a few hundred miles off Cape Cod. In the process of launching, a lift cable on *ALVIN*'s cradle snapped, and the submersible fell into the sea. Miraculously, the crew scrambled out before the vehicle sank in 5,500 feet of water (Fig. 3.27). The following summer, *ALUMINAUT* was able to put a lift hook into *ALVIN*'s open hatch and *USNS MIZAR* pulled it back to the surface; *ALVIN* was diving again in the summer of 1970.

*"I will be honest with you. This Administration cannot rush full speed ahead into marine development programs. The realities of national priorities and continuing inflation demand Executive discipline. All Federal expenditures have undergone sharp review. In many cases, we were forced to make painful reductions."*

—Address by Vice President Spiro Agnew  
Fifth Annual Conference of the  
Marine Technology Society  
16 June 1969, Miami Beach, Fla.

What was suspect earlier was now reality: There would be no "wet" NASA, and if submersibles were going to "make it," they would do so because there was a unique and necessary role they could perform. As far as national priorities were concerned, Viet Nam, domestic issues and established programs, such as outer space, took precedence over an expanding deep-ocean exploration program. While there was no cut in Federal ocean funds, the level of funding increased at

a rate to take care of inflation. Research and Development funds for Navy submersible leasing were increasingly more difficult to attain and justify in the face of other, more pressing, military requirements. Still, the impetus of the mid-sixties continued to produce additional submersibles.

A second Westinghouse vehicle *DEEPSTAR 2000* and its support catamaran *SEARCHSTAR* (initially called *MIDWIFE*) became available as a submersible system. Although small (45-ft LOA), *SEARCHSTAR* was a unique part of the 3-man, 2,000-ft submersible system, its design was hydrodynamically matched to the surface motion and mobility attributes of *DEEPSTAR 2000* (41), and it could be dismantled for rail or air transport. Originally assigned to Westing-



Fig 3.27 *ALVIN* at 5,025 feet as photographed from the U.S. Navy Research Laboratory's towed fish. (U.S. Navy)

house's San Diego facility as a part of its research inventory, the system was moved to Annapolis in 1971 and made available for leasing.

Another addition to the growing California Fleet was **SNOOPER**, a 2-man, 1,000-ft submersible built by Sea Graphics Inc. of Torrance for underwater photography. Farther north, International Hydrodynamics Ltd. added the 3,600-ft **PISCES III** to its inventory and put it to work on its U.S. Navy torpedo retrieval contract.

Across the Pacific, the first of the follow-on vehicles stemming out of **HIKINO** appeared, the 2-man, 300-ft **KUMUKAHI**. Built and operated at the Makapuu Oceanic Center by the Oceanic Institute at Waimanalo, Hawaii, **KUMUKAHI** (meaning "first of a series" in Hawaiian) had a 1 $\frac{1}{8}$ -inch-thick, 53-inch-diameter pressure hull made in four parts of plexiglass.

**KUMUKAHI** was to serve as a test vehicle for the far more ambitious DEEP VOYAGER Program. Though only a design, the submersible **DEEP VOYAGER** would conduct a transit from Hawaii to the U.S. by nothing more than taking on ballast and descending at a controlled glide and then attaining positive buoyancy at 20,000 feet by generating hydrazine gas and ascending at another specified glide ratio. A total of 48 ascents/descents was calculated to take the 3-man vehicle 2,400 miles across the Pacific in 16 days. The DEEP VOYAGER Project, estimated at \$2.25 million, never saw fruition and, after a few dives, **KUMUKAHI** itself was retired and put on display at Sea Life Park in Waimanalo.

The year 1969 also saw the advent of the Jules Verne-like **NR-I**. Though the majority of its construction and operational details are classified, the U.S. Navy's **NR-I** broke away from the constrictions of lead-acid batteries and incorporated a nuclear reactor into its 130-ft long hull. With a life support of 45 days and virtually unlimited power, the General Dynamics-built **NR-I** seems capable of research and surveying on a scale unapproachable by its contemporaries, and at an estimated cost of \$100 million (15) it is unlikely to be rivaled for some time to come.

Minute by comparison were the two 1-man, 1,600-ft **SP-500's** (**PUCE DE MER** or Sea

Fleas) launched by Cousteau's Office Francais de Recherches Sous-Marine (later becoming Centre D'Etudes Marine Avancees-CEMA) in Marseilles. Primarily for underwater photography, the 10-ft long **SP-500's** would be used to film much of the later television footage in which the Cousteau group so excels.

Other "firsts" were appearing in the submersible field. The Piccard-designed **BEN FRANKLIN** inauspiciously submerged in the Gulf Stream off Palm Beach, Florida on 14 July and surfaced 30 days later south of the Grand Banks. Only once during the 1,500-mile drift did the vehicle experience difficulty, and that occurred in the second week when an eddy carried it out of the Stream and required its support ship **PRIVATEER** to tow it back to the central core. For 30 days **BEN FRANKLIN's** hatches remained sealed and the unique, life support system supported the 6-man crew. An account of this trip is in Piccard's *The Sun Beneath the Sea* (42), and the flawless performance of **BEN FRANKLIN** is a tribute to his thoroughness and infinite capacity for paying attention to the minute details which can accumulate to ungovernable proportions if left unattended.

As **BEN FRANKLIN** silently drifted below the ocean's surface, the U.S. Space Program reached its culmination with the first moon landing. While the two events may appear unrelated, a NASA engineer aboard **BEN FRANKLIN** collected data on "man in isolation" which would be applied to the Skylab Project, an "orbital drift" of the seventies.

Throughout the U.S. submersible activity in private industry began to experience the worst of Mr. Horton's earlier forecast. An article in BUSINESS WEEK, "Research Subs on the Beach" (27 Dec 1969), saw an even gloomier 1970 season, and listed several submersibles (**STAR II** and **III**, **DEEPSTAR 4000**, **DOWB**, **BEAVER**, **DEEP QUEST**) as either laid up or idle. From the vantage point of large American industry, it was becoming painfully clear: The high water mark in long-term profitable submersible lease programs had been reached; the Federal government was not the only group making painful decisions.

1970

In spite of such omens, U.S. submersibles continued to appear, but, responding to the inordinate cost of the deep-diving large vehicles, shallower and less expensive vehicles entered the scene.

**NEKTON BETA** and **GAMMA** joined General Oceanographics' **NEKTON ALPHA** and leased out at the low cost of \$1,000/day, a rate far more accessible to money-short scientists than the \$6,000 to \$14,000/day cost of the larger, deep-diving vehicles. Later in the year, on 21 September, **NEKTON BETA** experienced a bizarre accident that took the life of passenger Larry A. Headlee and marked the first death in the field of deep submergence (see Chapter 15).

Sun Shipbuilding and Dry Dock Co. of Chester, Pennsylvania launched its candi-

date for low-cost, long-endurance missions, the tethered **GUPPY**. The 1,000-ft, 2-man **GUPPY** relied on a cable from the surface for power. The \$95,000 vehicle resembled the earlier **BATHYSHERE** only in appearance and surface reliance on electrical power; otherwise it had the operating capabilities of an untethered vehicle.

Furthering the concept of acrylic plastic pressure hulls, the U.S. Naval Civil Engineering Laboratory (NCEL) at Port Huene, California, constructed **NEMO** (Fig. 3.28), a 600-ft, 2-man vehicle with a pressure hull of twelve, 2.5-inch-thick, spherical plastic pentagons bonded together with adhesive. Capable of limited lateral maneuvering, **NEMO** was basically an underwater yo-yo. Attached to a wire cable beneath the vehicle was a 380-pound anchor on a pilot-controlled hydraulic winch. Anchoring itself to the bottom and attaining positive buoyancy, **NEMO** could ascend to a selected depth and hover "at anchor." While the panoramic and hovering stability offered advantages to the underwater worker, **NEMO** was another Navy-built vehicle to assess the feasibility of various components and materials—in this case acrylic plastic as a candidate for fleet submarines and other military devices.

Perry Submarine Builders delivered the first submersible to a petroleum-oriented customer. The 1,350-ft, 4-man **SURVEY SUB 1 (PC-9)** was built for Brown and Root Corp., in Houston, Texas, for use in the oil fields as a surveying platform and for inspection of pipelines and other production/transportation hardware.

With the originally-intended **DEEPSTAR 12000** hull, CEMA completed the **SP-3000** for Centre National pour l'Exploitation des Oceans (CNEXO) at Marseilles. The French **SP-3000** (recently designated **CYANA**) was to fill in the 0–10,000-ft depth range not amenable to the bathyscaph.

CEMA was also active at this period in construction of the Cousteau-proposed **ARGYRONETE** for France's CNEXO and IFP (Institut Francais du Petrole). **ARGYRONETE** would be a 1,970-ft, submersible composed of a large cylindrical pressure hull where passengers would live at atmospheric pressure and a smaller pressure hull where divers would live or lock-out at ambient pres-

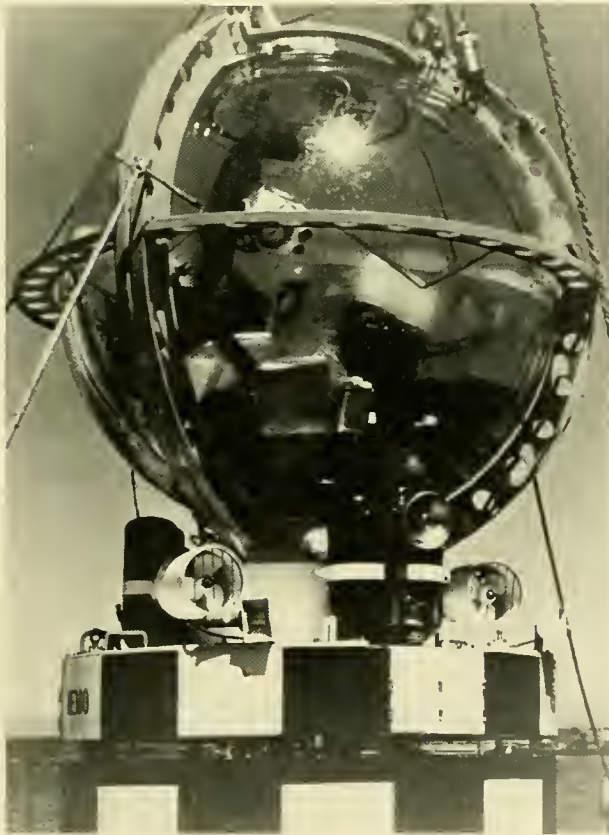

Fig 3.28 The U.S. Navy's **NEMO**. Now retired from Navy services, **NEMO** served to investigate the feasibility of acrylic plastic for deep submergence. (U.S. Navy)

sure (Fig. 3.29). Diesel-electric motors would provide it with surface propulsion and autonomy of operations. Lead-acid batteries would supply submerged power, and in combination with its life support system, a submerged dive of 8 days would be possible for the 10-man crew. However, when the pressure hulls were constructed and joined, further work on *ARGYRONETE* was halted to reconsider the project from a financial viewpoint and to study future uses of the vehicle (43). No further work has been reported since October 1971.

In 1970, Westinghouse Corp. also halted construction on the *DEEPSTAR 20000*. Possibly anticipating a Federal customer, design work on the 20,000-ft vehicle began in the optimistic atmosphere of 1966, but by 1970 Westinghouse, like others, could read the tea leaves and no customer for the \$5 to \$10 million submersible was foreseen. With the pressure hull and many other components completed, the never-assembled *DEEPSTAR 20000* went into storage.

With little need for a second *BEAVER*, North American Rockwell sold a spare set of *BEAVER* pressure hulls to International Hy-

drodynamics who configured the hulls into the lock-out vehicle *SDL-1* for Canadian Forces. Externally similar to the *PISCES*-class submersible, the 2,000-ft, 6-man *SDL-1* is capable of lock-out to 1,000 feet and would augment Canadian Forces' capability for military and scientific tasks.

Like their Canadian counterpart, the U.S. Navy also took delivery on a submersible in 1970, the first Deep Submergence Rescue Vehicle (*DSRV-1*). Capable of rescuing 24 men at a time from 3,500 feet (to be updated to 5,000 ft), *DSRV-1* (Fig. 3.30) was, and remains, the most complex, sophisticated undersea vehicle today, but the price tag was far beyond 1964 expectations. Originally estimated at \$3 million apiece, based on *ALVIN*'s cost, *DSRV-1* cost an estimated \$43 million (44). The original DSSRG recommendation for 12 such vehicles for a total of \$55 million was, to say the least, embarrassingly shy of the mark. Indeed, embarrassment was a common attribute among the earlier prognosticators of the nation's future in the sea. By the end of 1970, the deep submersible leasing/building curve was plummeting downward in the U.S. and the largest customer,

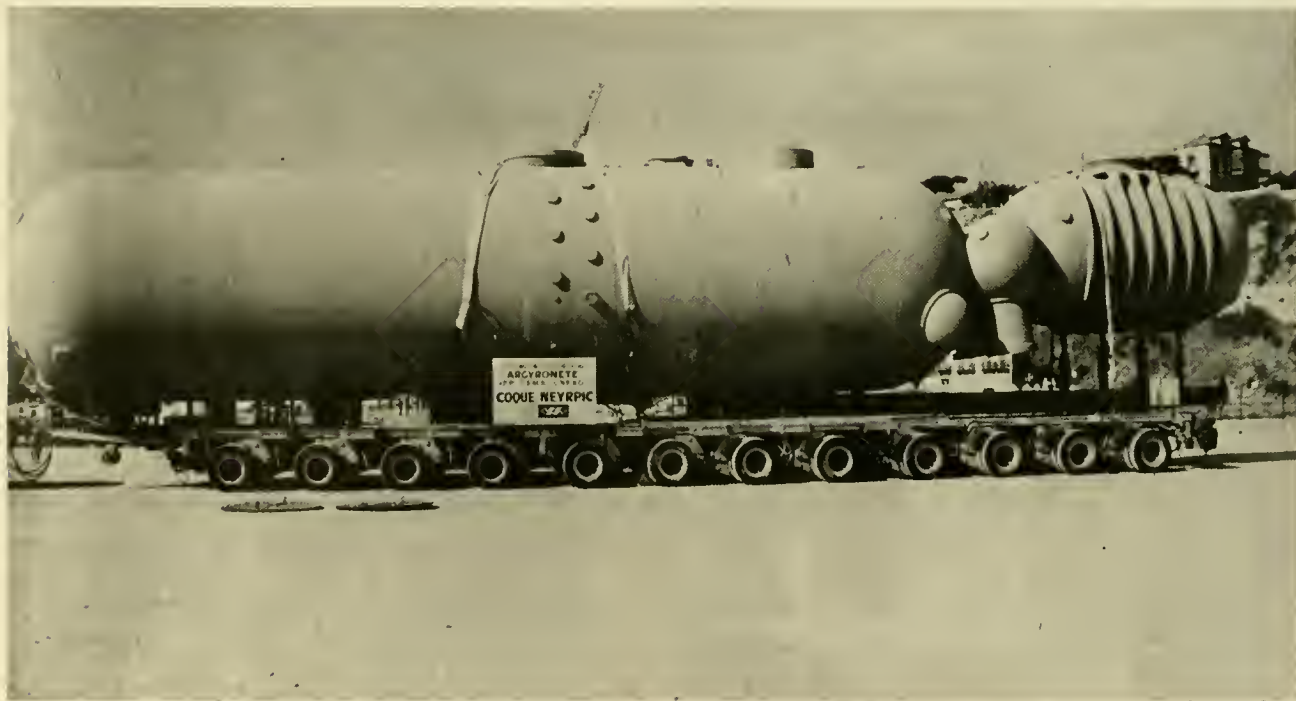

Fig. 3.29 The pressure hulls of *ARGYRONETE*. Offering, in concept, capabilities for underwater work far beyond that of present submersibles, *ARGYRONETE* has yet to proceed from this point of construction shown in 1971. (Thomas Horton)

the Navy, now had a broad-spectrum submersible capability of its own.

The DSSP was finding considerable difficulty in funding not 12, but merely 2 *DSRV*'s. A second 5,000-ft *DSRV-2* would be launched in 1971, but no further vehicles were planned. The fleet of submersibles for assistance in large and small object recovery was reduced to one Deep Submergence Search Vehicle (*DSSV*), and this never progressed beyond a preliminary design contract conducted by Lockheed. At an estimated \$60 to \$100 million apiece (15), the *DSSV* is not a likely candidate for construction. With 8 years separating *THRESHER* and the DSSP, the sense of urgency and the emotions of 1963 were absent from R&D funding circles. So much so, in fact, that the 1968 sinking of

another U.S. Navy submarine, *SCORPION*, in 10,000 feet of water passed with barely more than a ripple of concern relative to *THRESHER*. In the hard light of 1970 the need for even one *DSRV* was under close scrutiny. Submarine accidents, where the crew could be rescued, occurred at depths where the McCann Diving Bell or escape devices were more operationally practical than a *DSRV*. In cases such as *THRESHER* and *SCORPION* crush depth was exceeded, and any hope of rescue vanished. And furthermore, the practicality of a *DSSV* was questionable when unmanned devices—successors of *CURV*—had reached a level of competence where the advantages of man on the scene were outweighed by long-duration, less costly, unmanned remote search systems.

As Vice President Agnew projected, painful cuts were being made, and deep-ocean technology was feeling the surgeon's scalpel.

To exemplify the shortage of funds for deep submersible exploration, the Navy contracted its last- and only-charter of *DEEP QUEST* in April-May 1970 with the Naval Oceanographic Office. This organization also terminated its leasing of submersibles and foreclosed on the prospects for a Deep Ocean Survey Vehicle. Similarly, NEL and the Underwater Sound Laboratory terminated leasing for lack of funds.

The cost of maintaining a submersible made itself felt on the projected plans for work submersibles in Navy ranges. Originally slated for the AUTECH range, *SEA CLIFF* and *TURTLE* were beyond the operating budget of AUTECH and were transferred instead to the Navy's Submarine Development Group One (SUBDEVGRU-1), who also had *TRIESTE II* and *DSRV-1* under their aegis. With the acquisition of these vehicles, there was little further need of industry vehicles to perform Navy tasks.

Though the fact was yet to be recognized by all industry, it was not long coming: Leasing deep submersibles in the early 70's offered no potential for profit. During 1970-71 the fleet of privately-owned U.S. submersibles diminished: *DEEPSTAR 4000* was already in mothballs when joined by *DEEPSTAR 20000*; *ALUMINAUT* retired in 1971; *STAR I* went on display in the Philadelphia

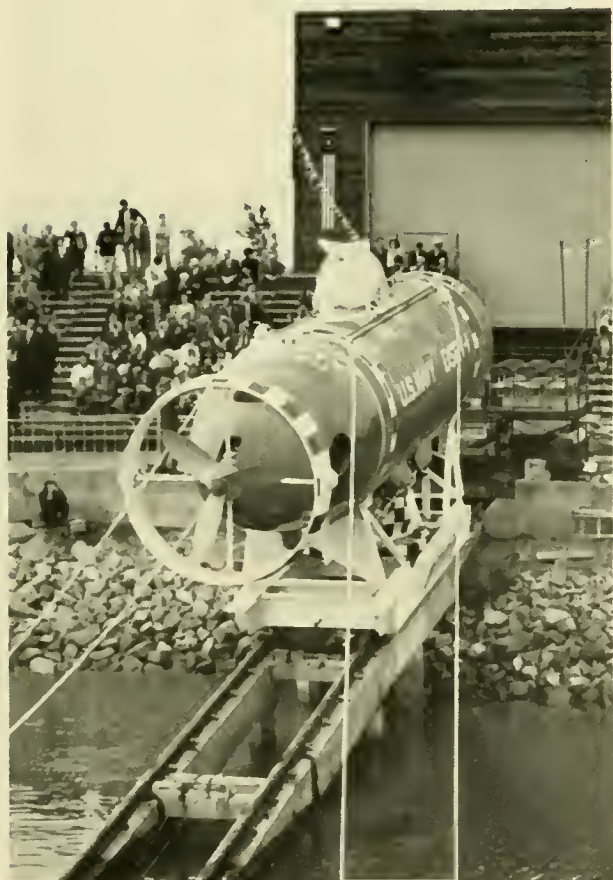

Fig 330 The first of two U.S. Navy rescue submersibles (*DSRV-1*) is launched in 1970 at San Diego, Calif. (U.S. Navy)

Maritime Museum; **DOWB** was given to Santa Barbara City College as a training aid for engineering students; **BEN FRANKLIN** was sold to Horton Maritime Explorations Ltd. in Vancouver, B.C.; **BEAVER**, after experiencing fire at 1,545 feet, was repaired and sold to International Underwater Contractors of New York. The promising aspect of the sixties was only that, as a “. . . new industry larger than aerospace” deep submergence would have to mark time. But as a capability which improved with age, the manned submersible capabilities of the 1970's profited by the experience of their predecessors.

### A MORE CONSERVATIVE APPROACH—THE 1970's

Submersible builders of the seventies, recognizing that great depth equaled great cost, pursued a more modest and inexpensive approach. Twenty submersibles were built from 1971 through 1973: Sixteen of these were less than 2,000-ft depth, 13 of which were 1,200-ft or less. The deep submersibles were the 6,500-ft **PISCES IV** and **V** and the 5,000-ft **DSRV-2**.

In another vein, the majority of submersibles—13—were built outside of the U.S. or for non-U.S. customers. Twelve were built under contract for a buyer or were assured of operational funding by a government or research foundation. Those built on lease speculation offered a particular capability to an identified customer: The offshore oil patch. A trend toward large-diameter viewing domes, or acrylic plastic hulls, was evident, as was lock-out capability. Absent were dashing crew uniforms and talk of large scale undersea exploration. The field of deep submergence was maturing. If the manned submersible was to survive, it would do so because it could compete with the diver, surface ship or other engineering, surveying and research devices.

Increased viewing capability utilizing large, acrylic plastic bow domes was seen in Perry Submarine Builders' 600-ft **PC-8**, the 1,025-ft **TUDLIK (PS-2)** and the 1,200-ft **VOL-L1 (PC-15)**. **TUDLIK** was constructed by a Canadian branch of Perry for leasing in that country, while **VOL-L1**, a lock-out submersible, was constructed on order for Vick-

ers Oceanics Ltd. in England. Departing from the standard **PISCES** configuration, International Hydrodynamics constructed the 1,200-ft **AQUARIUS I** (Fig. 3.31) with a 36-inch-diameter bow dome and Perry-like, battery-carrying skids.

A few blocks away from the energetic International Hydrodynamics group another submersible reappeared which once resided in California. **PAULO I** was sold in 1971 to Candive Ltd. of Vancouver and its pressure hull was contracted for long-term lease by Arctic Marine Ltd., also Vancouver-based. This new firm retained the general **PAULO I** outline, but configured and uprated the vehicle's depth into the 1,500-ft **SEA OTTER** (Fig. 3.32). Adding a new propulsion system, lights and cameras, and acquiring one of **BEAVER**'s versatile mechanical arms, Arctic Marine greatly improved the capacity of the original vehicle to perform a wider range of surveying and engineering tasks.

Mr. Edwin Link, an innovative and eminently successful pioneer in the American aircraft industry, turned his many talents toward the sea in the early sixties designing **DEEP DIVER** and a variety of ambient diving habitats and devices. In 1971 Mr. Link



Fig. 3.31 **AQUARIUS I** typifies the new breed of submersibles: shallow depth, simple construction and operation and panoramic viewing. (HYCO)



saw the launching of another of his designs: The 1,000-ft, diver lock-out **JOHNSON SEA LINK**. Donated by Link to the Smithsonian Institution and operated by the Marine Sciences Center at Ft. Pierce, Florida, **SEA LINK** incorporated a forward pressure sphere of plastic and an aft diver lock-out sphere of aluminum. Philanthropist Seward Johnson's sincere and abiding interest in the marine environment was, and remains, a chief factor in **SEA LINK**'s birth and continued operation.

In addition to securing its 5,000-ft **DSRV-2**, the U.S. Navy continued efforts toward material and component testing. In 1971 the 1,500-ft **DEEP VIEW** and 600-ft **MAKAKAI** were launched and placed, along with **NEMO**, under operational control of the Navy Undersea Center at San Diego. An early pioneer in submersible design and innovation (**DEEP JEEP**, **KUMUKAHI**, **DEEP VOYAGER**), naval engineer Willis Foreman designed the glass hemi-head **DEEP VIEW** to assess the problems encountered with joining glass and steel under high pressure-low temperature conditions. Borosilicate glass constitutes **DEEP VIEW**'s forward hemi-head and HY-100 steel its cylinder and after endcap. The

W/D ratio of glass is one of the lowest of all materials and its strength actually increases under pressure; hence, if some of its fabrication and jointing problems can be overcome, glass offers tremendous potential to undersea pressure capsules.

The acrylic plastic-hulled **MAKAKAI** was fabricated to assess various means (including use of fiber optics and photometers) of telemetering data through a plastic sphere *in lieu* of thru-hull penetrations and to evaluate and gain experience with cycloidal propulsion systems instead of conventional propeller-rudder type maneuvering.

The seventies saw the entrance of other European countries into the submersible field. Anticipating business from the newly-discovered and mushrooming North Sea oil fields, the Dutch company Nereid nv. of Schiedam constructed the 330-ft, 3-man **NEREID 330**. In addition to a wide range of viewing, **NEREID 330** is fitted with a 15-ft-long, 2,500-pound lift-capacity, mechanical arm with a gripping force of 6 tons. A second vehicle, **NEREID 700**, a 4-man, 700-ft submersible with diver lock-out capability, was delivered to Dutch Submarine Services of Amsterdam in the summer of 1973.

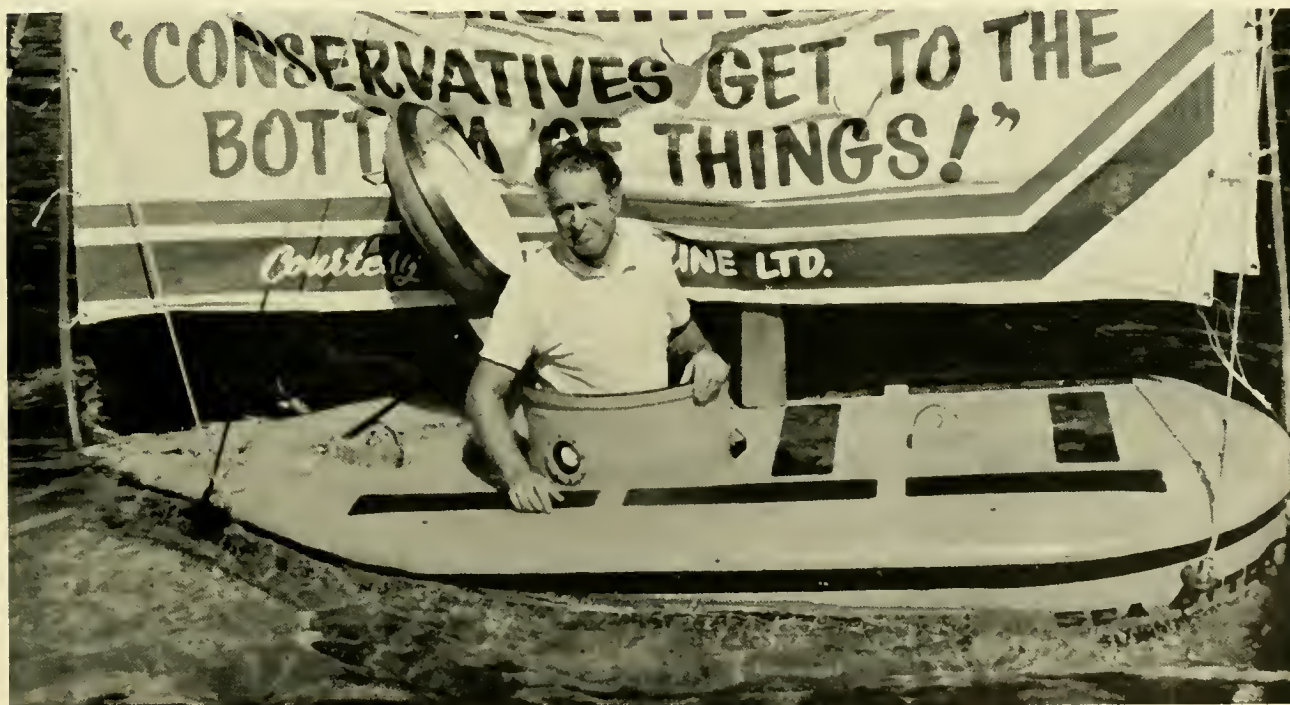

Fig 3.32 Although non-political by design, the Canadian submersible **SEA OTTER** is called to come to the aid of a party (Arctic Marine Ltd.)

The West German firm Bruker-Physik A.G. launched the 984-ft, 2-man *MERMAID I* in 1972 to fulfill a wide variety of tasks. The Karlsruhe-based firm is constructing a second craft, *MERMAID III*, to be launched in 1975; similar to its sister-vehicle, the later version includes diver lock-out and transfer capabilities.

A second West German firm, Maschinenbau Gabler GmbH of Lubeck, produced the 984-ft, 2-man *TOURS 64* and *TOURS 66* in 1971 and 1972, respectively. Differing in dimensions, the 66-boat being slightly larger, both have surface diesel-electric propulsion and a cruising range of 400 nautical miles. Both submersibles were built specifically for the unique role of "coral cracking" or gathering gem-quality red and pink deep-sea corals. The harvesting of this valuable coral—which lives beyond routine, compressed-air, ambient diving depths—was an early prognosti-

cation of the role submersibles might play. *TOURS 64* was delivered to the Taiwan-based firm of Kuofeng Ocean Development Corp. in Taipei; *TOURS 66* went to the Italian firm of SELMAR at Cagliari, Sardinia.

Adding to its country's small, but viable, submersible fleet, the Japanese firm of Kawasaki Heavy Industries built the 984-ft, 4-man *HAKUYO*, for continental shelf work by Ocean Systems Japan, Ltd. Launched in 1971, the versatile *HAKUYO* would be a private-industry vehicle for engineering and surveying work by other offshore interests.

At this writing the Perry company and International Hydrodynamics are each in the design and construction stage of several more submersibles. There is talk of a 20,000-ft Japanese submersible, but actual construction has not been reported.

Several—perhaps 10 or 20—small, shallow-diving submersibles were built during the

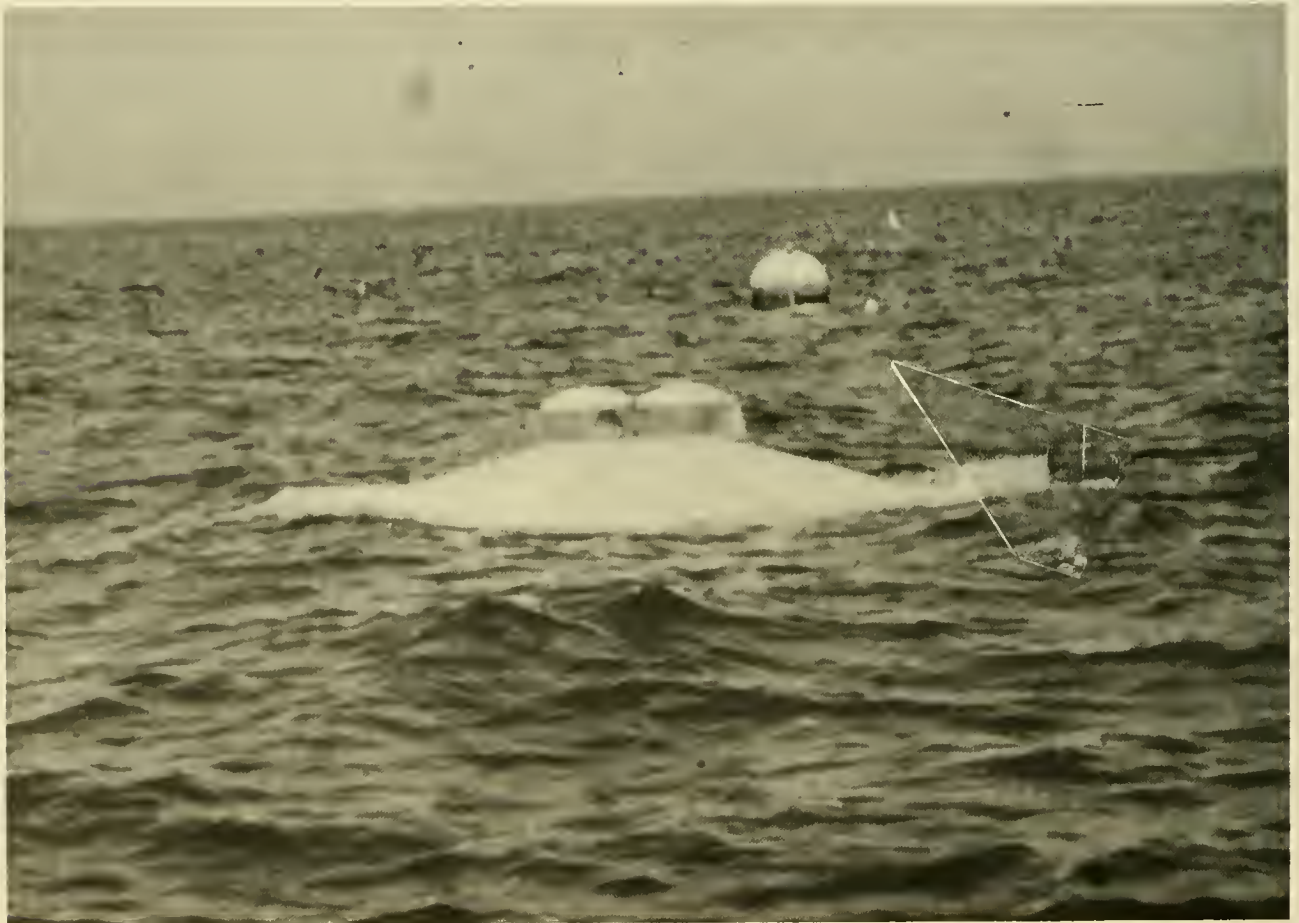
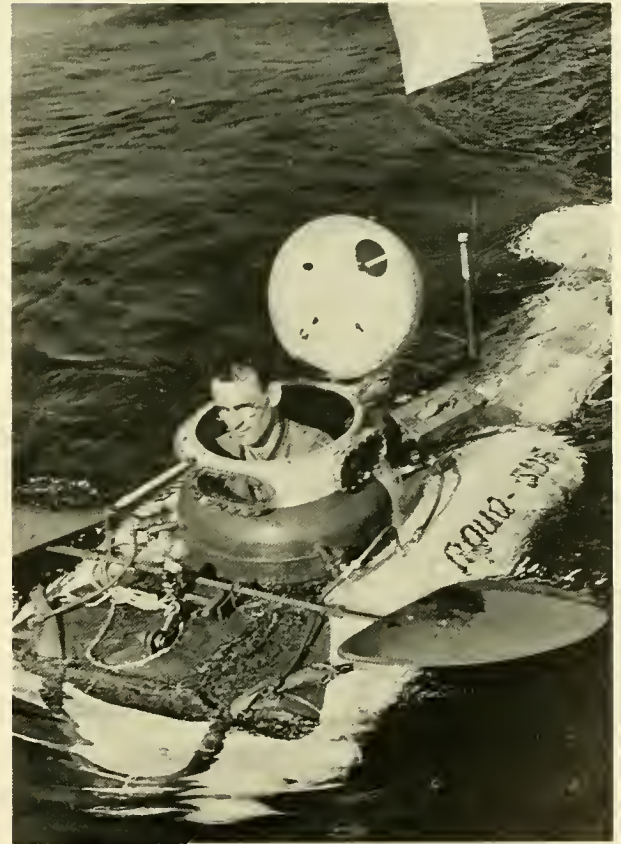
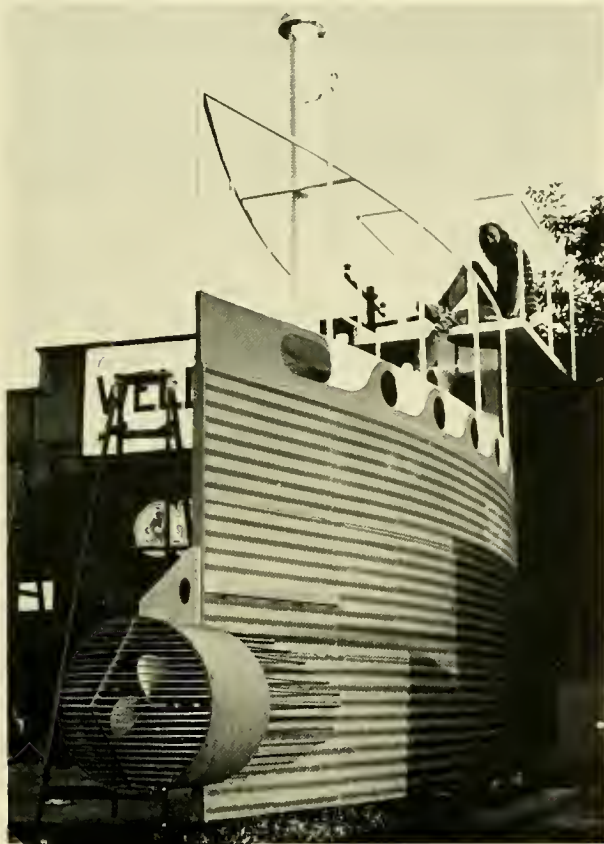
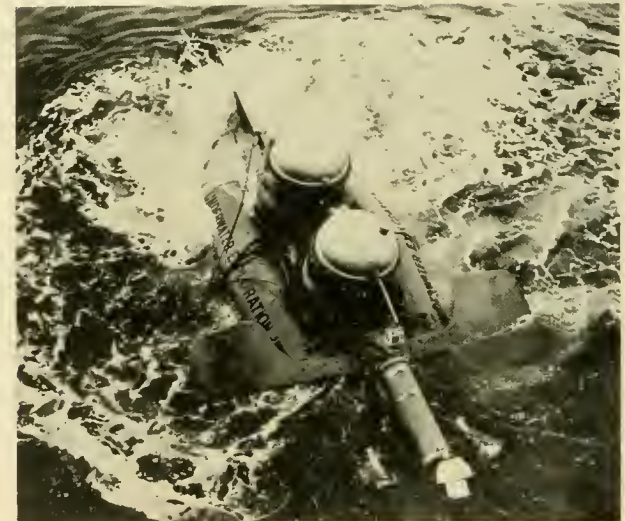
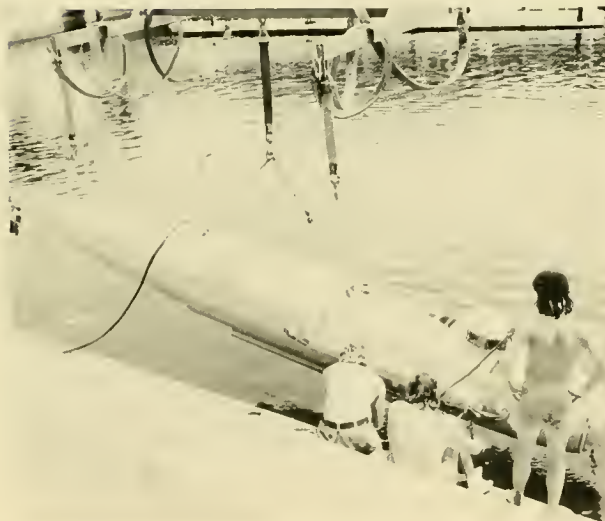
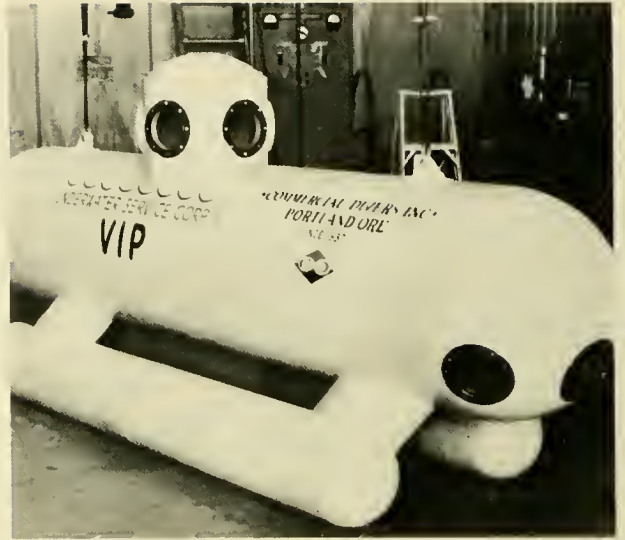
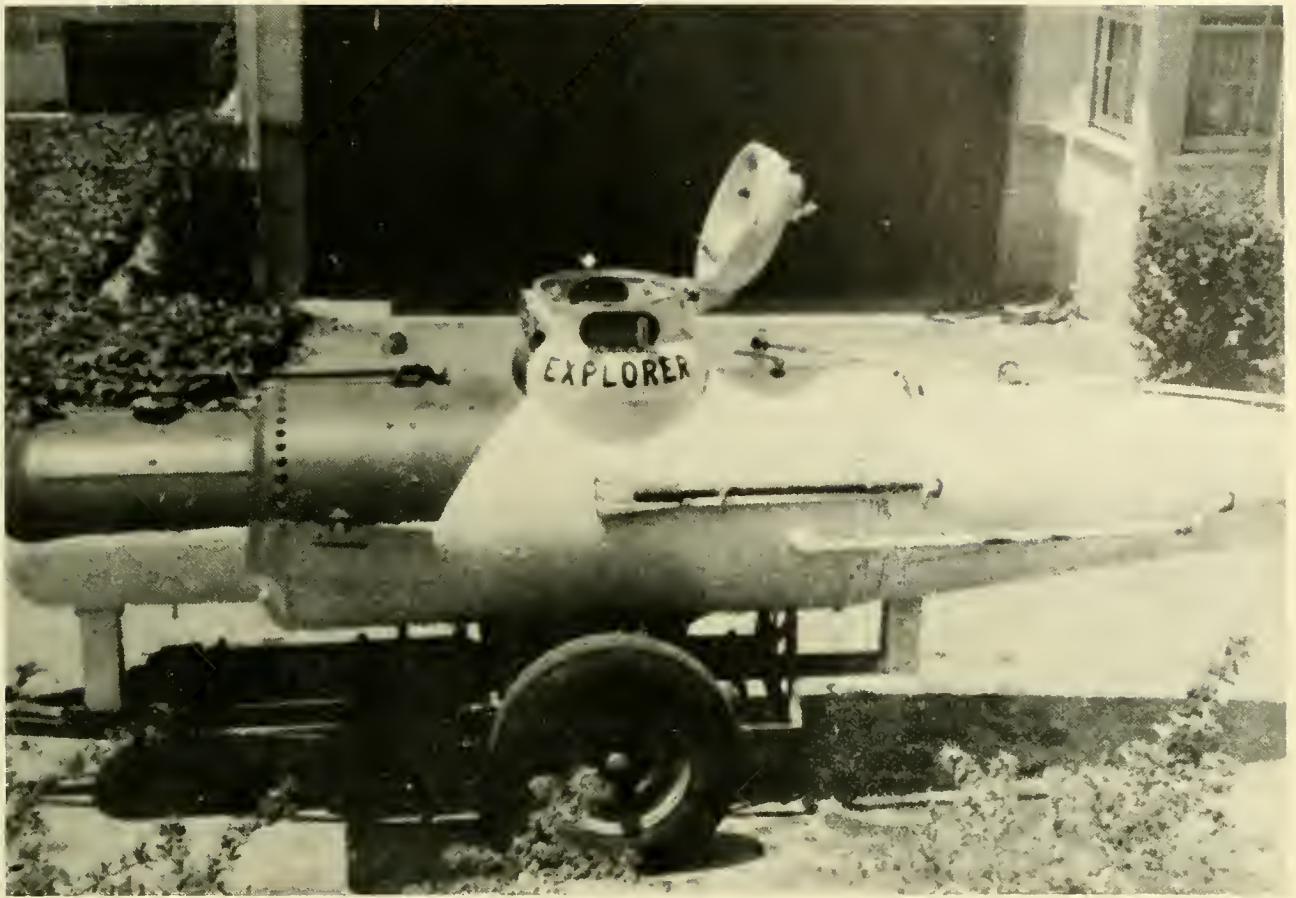

Fig. 3.33 A variety of one- and two-man shallow diving submersibles. (Douglas Prvitt, Gen. Oceanographics)







years covered above (Fig. 3.33), but their details are not available. From what can be gleaned, they incorporate the same general design and operational features as the *NEKTON*, *PC-3A*, *NAUILETTE* and *SPORTSMAN*-class submersibles. The reasons for their construction can probably be found in individual motivation, and detailing their design would likely reveal nothing more than what can be attained from those listed in Chapter 4.

Large American industry has all but stopped construction of submersibles; even to lease those built and now inactive would require guarantees of long-term leases which no present user can provide. Government leasing of submersibles in the U.S. has not completely stopped, but the scale is modest, and the user is purely scientific. In 1972 the National Oceanic and Atmospheric Agency's MUST (Manned Undersea Science and Technology) Program commenced leasing of submersibles for programs dealing with environmental research and monitoring and fisher-

ies research. Several hundred dives have been completed to date with *NEKTON*, *PC-8*, *SEA LINK* and *DEEPSTAR 2000*. The larger submersibles *DEEP QUEST* and *ALVIN* have also been chartered, but on a very modest scale. MUST's (now Manned Undersea Activities or MUA) less than \$1 million annual program is aimed at using the state-of-the-art capabilities of submersibles and not at investing funds to enhance their instrument or performance capabilities (45).

Emphasis in the submersible field has shifted from the Federal government to the offshore oil industry. Although the count varies, at least five vehicles are presently operating in the North Sea; the most ambitious operation being Vickers Oceanics Ltd., which owns *PISCES I, II* and *III*, *VOL-LI* and in 1973 leased *DEEP DIVER* and *SURVEY SUB 1*.

Large-scale international exploration of the Mid-Atlantic Ridge commenced in the summer of 1973 and will continue through 1974. This program, FAMOUS, will use *AL-*

*VIN, SP-3000* and *ARCHIMEDE* and is jointly funded by the French and American governments to survey and conduct research into the genesis and characteristics of this most impressive undersea mountain range.

It should be evident that the field of deep submergence is quixotic and, as Mr. Horton forecast some 6 years past, “. . . *what market there was would experience energetic competition with the weaker companies falling by the wayside.*” In 1968 it would have taken the foresight of Cassandra to prophesize Westinghouse, North American Rockwell, General Dynamics, Grumman Aerospace, Reynolds and General Motors as “weaker” companies. But if participation in submersible activities is the yardstick, then that is precisely the case, for each of these giant corporations has retired from active participation. Albeit, Westinghouse maintains token representation with *DS-2000*.

Interestingly, the stronger companies turned out to be “backyard” builders who offered simple, relatively inexpensive submersibles instead of the deep, sophisticated and expensive variety. Two submersible builders dominate today: Perry Submarine Builders and International Hydrodynamics Ltd. (HYCO). The Perry organization has built 13 vehicles (*PC3-X, PC-3A (1 & 2), PC-3B, PLC-4, PLC-4B, PC5-C, PC-8, PC-9, PC-15, PS-2, OPSUB, PC-14*) and is in the process of constructing 4 more. The majority of Perry’s business, however, resides in the construction of diver delivery and support systems, not submersibles. On the other hand, HYCO remains strictly a submersible builder and has completed seven to date (*PISCES I, II, III, IV, V, SDL-1, AQUARIUS I*) with orders for six more (*PISCES VI, VII, VIII, AQUARIUS II, ARIES I & II*) on the ledger.

Determining the number of operating submersibles is quite difficult owing to the sporadic nature of their use; some dive full time; others, perhaps 1 or 2 months out of the year. In any event, some 58 out of the more than 100 submersibles built since *FNRS-2* are operating. The status of individual vehicles is given in Chapter 4; it is of interest to note that most of the operational submersibles are shallow ones, and dive to less than 2,000 feet. The deeper vehicles are largely

government-supported vehicles of the United States and France.

Scientific diving is now a small part of submersible activities; instead, engineering tasks, such as pipeline and cable inspection, are the dominant activities. And, at the moment, the submersible industry has focused on the North Sea.

Since discovery and development of the North Sea oil in the late sixties and early seventies, Vickers Oceanics Ltd. of Barrow-in-Furness has been and is the major supplier of submersible services in this area. In a 1972 report, Goudge (46) shows a 1969 total of 40 operating days for *PISCES II* growing to a total of 500 operating days for three submersibles (*PISCES I & II* and an unidentified diver lock-out vehicle) in 1972.

Two of the most obvious questions concerning this resurgence in submersible activity is why now and why the North Sea? Mr. G. S. Henson of Vickers presented his answers in a report at a Heriot-Watt University Seminar in early December 1973. The North Sea can be one of the most inhospitable areas in the world and, according to Henson, its conditions are characterized by:

- Average sea states and extremes of weather conditions significantly worse than previously encountered in routine offshore operations.
- Strong tidal currents and turbidity.
- Greater water depths than previous oil extracting workings; 650 feet at present with oil-bearing potential extending to depths of 975 feet to 2,000 feet for future development.
- Low water temperature.

Within these conditions a diver quickly runs out of breathing gas and strength and is frequently cold and frightened. Additionally, the diver stirs up a cloud of bottom sediments and is unable to wait for it to clear because of his limited gas supply. From a mechanical point of view, divers offer little or no power at their elbows.

Acknowledging the technical limitations of remote submersible work tools, Henson lists their advantages over the diver as being a “shirt sleeve” environment, a reasonable power supply and the ability to bottom for several hours to wait until conditions clear.

Working in concert with the diver, who can provide specialized functions, the lock-out submersible will improve his performance by conserving life support, removing the fear of loneliness, providing additional power for tooling and improving work time by using the submersible's freedom for search and approach to the work site. Henson predicts that by 1980 the submersible and the saturated ambient diver will be equals in annual earnings (utilization). One might take issue with such predictions, but the orders of magnitude of submersible utilization shown by Goudge are irrefutable evidence of an increasingly significant role for such vehicles in the North Sea.

Predictably, Vickers' activities have not gone unnoticed by other submersible owners.



Fig 3.34 This 55-ton hyperbaric section of *PHOENIX 66* will be encapsulated into a 70-ft-long submersible for oil field work to 1,200 feet with a crew of seven (Sub Sea Oil Services, Milan)

HYCO's *PISCES V* and one *ARIES* are slated for North Sea leasing under their new parent organization, Peninsular and Orient Steamship Lines. Sub Sea Oil Services of Milan, Italy has acquired the *PS-2* and the *PC5C* and is building an immense, mobile working habitat designated *PHOENIX 66* (Fig. 3.34) for North Sea application by 1974. Taylor Divers' *TS-1* is now working on a long-term charter in the North Sea and other European firms stand ready with their entries.

The "new" future of submersibles is promising indeed, but the former participants might correctly advise the newcomer to proceed with caution. Whether they will heed such advice is speculative, for once again the manned submersible finds itself a most newsworthy item:

*"The energy crisis has created demand for little submarines to lay underwater pipelines and explore along the ocean floor for oil. Suddenly the demand (for submersibles) far outstrips supply as oil exploration activity picks up."*

—THE CHRISTIAN SCIENCE MONITOR  
22 January 1974

## REFERENCES

1. Beebe, W. 1934 *Half Mile Down*. Harcourt, Brace & Co., New York.
2. Mark, R. F. 1967 *They Dared The Deep*. The World Pub Co., New York.
3. Piccard, A. 1954 *In Balloon and Bathyscaphe*. Cassell & Co. Ltd., London.
4. *U.S. Navy Diving Manual*. 1970 NAVSHIPS 0994-001-9010, Navy Dept., Washington, D.C., 687 pp.
5. Houot, G. S. and Wilhm, P. H. 1955 *2,000 Fathoms Down*. E. P. Dutton & Co., New York.
6. Maxwell, A. E., Lewis, R., Lomask, M., Frassetto, R. and Rechnitzer, A. 1957 *A Preliminary report on the 1957 investigations with the bathyscaph, TRIESTE* (unpub. manuscript).
7. Dr. Andres Rechnitzer, Office of the Oceanographer of the Navy, Alexandria, Va. (Personal Communications)

8. Terry, R. D. 1966 *The Deep Submersible*. Western Periodicals Co., North Hollywood, California, 456 pp.
9. Piccard, J. and Dietz, R. S. 1960 *Seven Miles Down*. G. P. Putnam's Sons, New York.
10. Dr. Melchiorre Masali, Univ. of Torino, Torino, Italy (Personal Communication).
11. Edmund S. Martine, *SUBMANAUT* Enterprises, Miami Beach, Florida (1967 Personal Communication).
12. Burt L. Dickman, Auburn, Indiana (1973 Personal Communication).
13. Cousteau, J. Y. 1956 *The Living Sea*. Harper & Row, New York.
14. Cousteau, J. Y. and Dumas 1953 *The Silent World*. Harper & Row, New York.
15. Shenton, E. H. 1972 *Diving For Science*. W. W. Norton & Co., New York.
16. Parrish, B. B., Akyuz, E. F., Anderson, J., Brown, D. W., High, W., Peres, J. M. and Piccard, J. 1972 *Submersibles and underwater habitats; a review*. Underwater Jour., August, p. 149-163.
17. Toggweiler, M. 1966 *SUBMARAY, Two-man utility submarine*. A paper presented at the AIAA Symposium on Modern Developments in Marine Sciences, Los Angeles, California, 21 April 1966.
18. Rechnitzner, A. B. and Walsh, D. 1961 *The U.S. Navy bathyscaph TRIESTE, 1958-1961*. A presentation to the Tenth Pacific Science Conference, Honolulu, Hawaii, 21 August-September 1961.
19. Undersea Tech. 1962 July/August.
20. Covey, C. W. 1964 *ALUMINAUT*. Undersea Tech., v. 5, n. 9, p. 16-23.
21. Harter, J. R. R. 1964 Personal Communication to Undersea Technology printed in March 1964.
22. Munske, R. E. 1964 *ALUMINAUT near completion*. Undersea Tech., April 1964.
23. Undersea Tech., April 1963.
24. Andrews, F. A. 1965 *Search operations in the THRESHER area 1964*. Naval Engineer's Jour., August & October 1965 (2 sections).
25. Galantin, I. J. 1965 *Vehicles for deep ocean technology*. Shipmate, May, p. 24-29.
26. Forman, W. R. 1966 *DEEP JEEP from design through operation*. Jour. Ocean Tech., v. 1, n. 1, p. 17-23
27. Undersea Tech., September 1964.
28. Loughman, R. and Butenkoff, G. 1965 *Fuel cells for an underwater research vehicle*. Undersea Tech., Sept., p. 45-46.
29. Vetter, R. C. 1970 *Growth and Support of Oceanography in the United States 1958-1968*. National Academy of Sciences-National Resource Council Report, 44 pp.
30. Federal Marine Science Program, Fiscal Years 1968-1969 and 1970.
31. Thomas F. Horton, Living Sea Corp., Los Angeles, California (Personal Communication).
32. Andrews, F. A. 1967 *An analytical review of lessons learned from the H-Bomb sea search off Spain. Pt. 1, Search, classification, and recovery*. Proc. 4th U.S. Navy Sym. Military Oceanog., v. 1, p. 3-28.
33. Gaul, R. D. and Clarke, W. D. 1968 *GULFVIEW Diving Log*. Gulf Univ. Res. Corp., Pub. No. 106, College Station, Texas, 37 pp.
34. Summary of Commercial Leasing by Navy Activities. Enclosure (1) to Chief of Naval Materials ser. ltr. MAT 0327/DUB of 27 June 1969.
35. Slates, E. F. 1968 *HIKINO mock-up, an operational two-man catamaran submersible*. Naval Weapons Center Tech. Note 404-65-68, 39 pp, 2 appendices.
36. Lang, R. G. and Scholtz, P. D. 1963 *A two-man plexiglass submarine for oceanic research*. Undersea Tech., April, p. 26.
37. Ocean Industry 1969, v. 4, n. 1.
38. Munz, R. 1967 *PX-15: A design for future needs*. Data Magazine, November.
39. Horton, T. F. 1968 *Inside undersea vehicle systems*. The Ocean and the Investor. Dean Witter & Co. Pub., p. 75-82.
40. R. Bradley, Arctic Marine Ltd., Vancouver, B.C. (Personal Communication).
41. Westinghouse Ocean Research Laboratory. 1971 *DEEPSTAR/SEARCHSTAR Research Submersible System CD-71-7-800*, 15 pp.
42. Piccard, J. 1971 *The Sun Beneath The Sea*. Charles Scribner's Sons, New York, 405 pp.
43. La Prairie, U. 1972 *Recent achievements of the French in offshore technology*. Ocn. Ind., April, p. 115-120.



44. Undersea Tech., October 1969.
45. Miller, J. W. and Beaumariage, D. C. 1972 ***NOAA's Manned Undersea Science and Technology Program***. National Oceanic and Atmospheric Agency (unpublished manuscript).
46. Goudge, K. A. 1972 ***Operating experience with PISCES submersibles***. Conf. Papers. Oceanology International '72, Brighton, England, 19–24 March 1972, p. 270–273.





# 4

## MANNED SUBMERSIBLES: 1948-1974

The construction and performance characteristics of 88 submersibles built or under construction during the period 1948 through 1974 are presented in the following pages. Not all submersibles built during this period are represented, but only those for which sufficient details are available to provide an adequate description. In some cases there are several vehicles of one type; for example, the *K-250* is one of nine vehicles built to a design of Mr. G. Kittredge; 10 additional pressure hulls of this design were constructed, but there is no indication that they saw completion to a final vehicle. The *SPORTSMAN 300* and *600* series are other examples where some 20 models are alleged by various sources to have been constructed,

but only 3 can be accounted for in the literature and from personal communications within the field. In all then, over 132 submersibles, not including the Soviet bloc, were built to at least the pressure hull stage of completion in this 26-year period. For ready reference and from a historical aspect, Table 4.1 lists all known vehicles and their pertinent characteristics.

The great majority are one-of-a-kind and show little commonality in design and performance. This diversity of design is matched by diversity in definition of terms used to describe the various vehicles and their performance characteristics. "Payload" and "Endurance," for example, may be defined quite differently by the owner and the user,

and both, for their own purposes, may be correct. For reasons of clarity, definitions of the dimensional and performance terms used in the following descriptions are given below. Definitions of the specific terminology used within these categories can be found in the appropriate chapters.

## DIMENSIONAL/PERFORMANCE TERMS

**Length, Beam, Height, Draft:** See Figure 4.1.

**Weight (dry):** In-air vehicle weight in a ready-to-dive condition with only operating and hotel equipment aboard.

**Operating Depth:** The deepest depth a submersible can operate and maintain a specified safety factor, usually 1.5 or greater.

**Collapse Depth:** The computed depth (determined by model testing or calculations based on materials testing) at which a pressure-resistant structure, *e.g.*, pressure hull, will fail owing to ambient pressure.

**Hatch diameter:** Least diameter of the personnel entrance orifice in the pressure hull. Where the opening is a truncated cone this dimension is the minimum diameter.

**Life Support:** The total time (in hours), including normal and emergency systems, available to sustain one "average" man within a closed pressure hull. (See Chapter 9 for definition of an "average man.")

**Total Power Capacity:** Total electrical power, in kilowatt hours (kWh), a submersible's power plant can generate to supply propulsion, hotel load and scientific work equipment. Derived from (total voltage X ampere hours) /1,000.

**Speed/Endurance:** Expressed in knots (6,080 ft/hr) and calculated, not from total kWh, but from that portion of the power supply devoted to propulsion. The employment of lights, echo sounders and other equipment requiring electrical power will detract from the endurance stated.

**Pilot:** The number of individuals required to safely control the submersible in all aspects of a dive.

**Observers:** The number of individuals a submersible may routinely carry on a dive who are in no way required for control of the submersible.

**Payload:** The total weight which may be placed aboard (internally and externally) a submersible after the pilots/observers and all other equipment or supplies are aboard which are required to conduct a dive to its operating depth under routine, safe conditions.

## COMPONENT/SUB-SYSTEM TERMS

**Pressure Hull:** The pressure-resistant component of a submersible wherein the human occupants reside.

**Ballast/Buoyancy:** The means whereby a submersible attains negative or positive buoyancy to dive and surface, and to attain small-scale changes in  $\pm$  buoyancy when submerged.

**Propulsion/Control:** The devices a vehicle carries to propel it horizontally (main propulsion), vertically and laterally (thrusters), and the systems (dive planes and rudders) used to control its attitude (pitch, roll, yaw) underwater.

**trim:** The systems available to attain up/down bow angles (pitch) or list angles (roll) through movement of weights or liquids forward or aft, or port/starboard. In some instances a builder defines trim as the means to attain small-scale buoyancy adjustments when submerged; where this is the case, it has been included under Ballast/Buoyancy.

**Power Source:** The nature and total quantity of onboard energy (mainly electrical) carried by the submersible when diving.

**Life Support:** The oxygen supply, carbon dioxide removal systems, temperature control devices, atmospheric monitoring instruments, etc., carried aboard.

**Viewing:** Dimensions, quantity and location of viewports and other devices providing the occupants of the pressure hull direct viewing of the external environment.

**Operating/Scientific Equipment:** Permanently installed submersible equipment used: 1) By the operator—to communicate on and under the surface, to monitor vehicle attitude and location and to determine the presence of possible hazards; 2) By the observer—to attain environmental information such as water temperature, bottom relief,

etc. This category is the most likely subject for change.

**Manipulators:** The devices with capabilities approximating those of the human arm and hand and which permit an operator within the submersible to carry out specific work functions outside the submersible.

**Safety Features:** Systems or components whereby the occupants of the vehicle may deal with emergencies such as power loss, normal deballasting loss, fire, entanglement, etc.

**Surface Support:** The combination of equipments, systems and personnel necessary to transport, prepare for launch, launch, track, communicate with, retrieve and otherwise service the submersible and its occupants before, during and after actual diving operations.

With the advent of the *C5A* all submersibles, excluding *AUGUSTE PICCARD*, *ARGYRONETE*, *NR-1* and the bathyscaphs, are air, sea and land (truck or rail) transportable. Only a few have a permanent support platform; for those that do, the name and nature of the support platform is included. Submersibles relying on charter ships or "Ships of Opportunity" are noted as "*SOO*."

**External Lighting:** Lights located outside the pressure hull are used for viewing, piloting, etc. The majority of submersibles have a capability for external illumination; those that do not, need merely purchase an off-the-shelf underwater light. Rearrangement and modifications to lights are quite common and simple to conduct. For these reasons no description of a submersible's lighting arrangement or quantity is provided, for it is too likely to change.

The references provided are the sources from which descriptions of specific submersibles were obtained. In many instances the data was acquired from builders' brochures or specifications. In some cases it was derived from personal contact with the builder; where this is the case it is so noted.

## REFERENCES

**ALL OCEAN INDUSTRIES** Fact sheet and Operating Instructions from All Ocean Industries, Inc., Houston, Texas

**ALUMINAUT** Sheets, H.E. and Loughman, R.R. 1964 *The ALUMINAUT*. Paper presented at the 1st Ann. Meeting of the American Institute of Aeronautics and Astronautics, Wash., D.C., 29 June-2 July 1964. AIAA No. 64-459

**ALVIN** Mavor, J.W., Froehlich, H.E., Marquet, W.M. and Rainnie, W.O. 1966 *ALVIN, 6,000-ft submergence research vehicle*. Paper presented at the Ann. Meeting, New York, N.Y., Nov. 10-11, 1966 of The Soc. of Naval Architects and Marine Engineers, n. 3, 32 pp.

**AQUARIUS I**  
**ARIES I**  
**PISCES I, II,**  
**III, IV, V** International Hydrodynamics Inc., North Vancouver, B.C. Fact sheets and personal communications with staff members. Vickers Oceanics Ltd. advertising brochure

**ARCHIMEDE** *Le Bathyscaph ARCHIMEDE*. Technical brochure published by D.C.A.N. Toulon, March 1971

**ARGYRO-NETE** Willm, P. 1971 *Project ARGYRONETE*. A talk delivered at the OCEANEXPO Colloquium 9-12 March 1971, Bordeaux, France

**STAR II**  
**ASHERAH** Brancart, C.P. and Hoffman, G.H. 1967 *STAR II A second generation research submarine*. Trans. 3rd Ann. Mar. Tech. Soc. Conf. & Exhibit, 5-7 June 1967 San Diego, Calif., p. 459-478

**AUGUSTE PICCARD** *The submarine AUGUSTE PICCARD*. Technical Description published by The Swiss National Exhibition, Lausanne, Switzerland 1964

**BEAVER** Black, D.C. 1968 *BEAVER MK IV Submarine Work Boat*. Tech. Description T8-1473/020. Ocn. Sys. Operations of North American Rockwell Corp., Anaheim, Calif.

- BEN FRANKLIN** Grumman Aircraft Engineering Corp., Bethpage, New York. 1969 **BEN FRANKLIN, Brief Systems Description**
- BENTHOS V** Data and Controls Div., Lear Siegler Inc., Deep River, Conn. (Response to the Committee on Marine Research, Education and Facilities (IC-MAREF) questionnaire, 1969 and personal communication from Garrison Divers, Corp., to CDR R. Nevin of NOAA)
- DEEP DIVER PC-3A (1&2)** Fact Sheet Perry Submarine Builders, Riviera Beach, Fla., and personal communications with Perry staff
- PC-3B**
- PC3-X**
- PC5C**
- PC-8**
- PC-14**
- PS-2**
- SHELF DIVER SURVEY SUB 1 VOL-L1**
- DEEP JEEP** Forman, W.R. 1966 **DEEP JEEP from design through operation**. Jour. Ocn. Tech., v. 1, n. 1, p. 17-23
- DEEP QUEST** Lockheed Missiles & Space Co. 1968 **Lockheed DEEP QUEST Submersible System**. LMSC/D080197 Revision b
- DEEPSTAR 2000** Eliot, F. 1967 **The design and construction of the DEEPSTAR 2000**. Trans. 3rd Ann. Mar. Tech. Soc. Conf. & Exhibit, 5-7 June 1967, San Diego, Calif., p. 479-492
- DEEPSTAR 4000** Westinghouse Electric Corp. 1967 **DEEPSTAR-4000 Operation and Maintenance Manual**, v. 1, pt. 1, Pub. A32213B710  
Shenton, E.H. 1968 **Exploring The Ocean Depths**. New York, W.W. Norton & Co.
- DEEPSTAR 20000** Pritzlaff, J.A. 1970 **DEEPSTAR-20,000**. Trans. Mar. Tech. Soc. 6th Ann. Conf. & Expo. v. 2, p. 817-836
- DEEP SUBMERGENCE RESEARCH VEHICLE** Northrop Services, Inc., Arlington, Va. 1972 Proposed **DSRV Operational Manual**. Contract N00024-72-C-0207
- DEEP VIEW** Forman, W.R. 1972 **Development & sea trials of the glass submersible DEEP VIEW**. Preprints The 2nd International Ocn. Dev. Conf., Tokyo, v. 1, p. 810-819
- DOWB** Daubin, S.C. 1967 **The Deep Ocean Work Boat (DOWB) an advanced deep submergence vehicle**. Paper No. 67-360 of Joint AIAA/SNAME Advanced Marine Vehicle Meeting, Norfolk, Va., 22-24 May
- FNRS-2 TRIESTE I FNRS-3** Piccard, A. 1956 **Earth, Sky and Sea**. Oxford Univ. Press, New York
- GOLDFISH** Dickman, B.L., Auburn, Indiana (personal communication)
- GRIFFON** Foex, J.S. 1974 **Le GRIFFON**. L'Aventure Sous-Marine Techniques et Exploration, n. 97, p. 18-21
- GUPPY** Watson, W. 1971 **The design, construction, testing and operation of a deep-diving submersible for ocean floor exploration**. Paper presented in the Transactions of the Annual Meeting of The Society of Naval Architects and Marine Engineers, Nov. 11-12, New York, p. 405-433
- HAKUYO** Arakai, A. 1972 **The Operation by the HAKUYO**. Preprints The 2nd International Ocean Dev. Conf., Tokyo, v. 1, p. 820-828
- HIKINO** Slates, E.F. 1968 **HIKINO Mock-up, an operational two-man catamaran submersible**. Naval Weapons Center Tech. Note 404-65-68. 38 pp. with Appendices
- JIM** 1973 **One atmosphere diving suit passes tests for deep**

- water*. Ocean Ind., Aug., p. 26-28
- JOHNSON SEA LINK** Kelsey, R.A. and Dolan, R.B. 1970 *The JOHNSON-SEA-LINK—The first deep diving welded aluminum submersible*. Trans. Amer. Soc. Mech. Eng. Winter Ann. Meeting, Nov. 29-Dec. 3, New York, Pub. No. 70 WA/Unt 6, 12 pp.
- K-250** Kittredge, G., Kittredge Industries, Inc. Warren, Me., 04864 (A brochure, no date)
- KUMUKAHI** Forman, W.R. 1970 **KUMUKAHI** paper presented at ASME Ann. winter meeting. (70-WA/Unt-11)
- KUROSHIO II SHINKAI YOMIURI** Sasaki, T. 1970 *On underwater observation vessels in Japan*. Preprints Mar. Tech. Soc. 6th Ann. Conf. & Expo., June 29-July 1, Wash., D.C., v. 1, p. 227-262
- MAKAKAI** Talkington, H.R. and Murphy, D.W. 1972 *Transparent Hull Submersibles and the MAKAKAI*. NURDC Rept. NUC TP 283, 24 pp. NURDC Hawaii Laboratory, 1970 *A systems Description of the Transparent Hulled Submersible MAKAKAI* (unpub. manuscript)
- MERMAID I/II & III/IV** Bruker-Physik A.G., Karlsruhe, West Germany, Vehicle fact sheets and personal communication with Mr. J. Haas
- MINI DIVER** Great Lakes Underwater Sports Inc., Elmwood Park, Ill. Personal communication with Mr. J. Strykowski
- NAUTI-LETTE** Brochure from Nautillette Inc., Ft. Wayne, Ind.
- NEKTON ALPHA, BETA, GAMMA** Personal communication with Messrs. Douglas Privitt and J. W. Vernon of General Oceanographics, Inc., Newport Beach, Calif.
- NEMO** Rockwell, P.K., Elliott, R.E. and Snoey, M.R. 1971 *NEMO, a new concept in submersibles*. NCEL Tech. Rept. R749, 68 pp.
- NEREID 330** Personal communication with Dr. Ir. H.H. Lok of Nereid nv. Yerseke, Holland
- OPSUB** *OPSUB Instruction, Operation and Maintenance Manual*. Ocean Systems Inc., 11440 Isaac Newton Industrial Sq. N., Reston, Va. 22090
- PAULO I** Fact sheet from Anautics, Inc., San Diego, Calif., 1969
- SDL-1** *Systems Description and Operations Manual. SUBMERSIBLE DIVER LOCK-OUT (SDL-1)*. Canadian Forces Technical Order C-23-100-000/MG-V01, dated 18 July 1973, prepared by International Hydrodynamics Ltd.
- SEA CLIFF TURTLE TRIESTE II** U.S. Navy Submarine Development Group One, San Diego, Calif. Fact Sheets and personal communication with Group personnel
- SEA OTTER** Arctic Marine Ltd., North Vancouver, B.C. Personal communication with R. Bradley and staff members
- SEA RANGER** Verne Engineering, Mt. Clemens, Mich. **SEA RANGER 600**. (Technical Description of general capabilities)
- SEA-RAY** Submarine Research and Development Corp., Lynnwood, Wash. (Response to IC-MAREF questionnaire)
- SNOOPER** Undersea Graphics, Torrance, Calif. Design Information on Undersea Graphics 2-man Submersible **SNOOPER**
- SP-350** Cousteau, J.Y. and Dugan, J. 1963 *The Living Sea*. New York, Harper & Row
- SP-500** Small Bathysphere **PUCES 500**. Technical description from Centre D'Etudes Marine Avancees, Marseilles, France

<b>SP-3000</b>	CNEXO technical description <b>SOUCOUBE PLONGEANTE</b> , S.P. 3000	tionnaire, 1969) and personal communications
<b>SPORTSMAN 300 &amp; 600</b>	Terry, R.D. 1966 <i>The Deep Submersible</i> . Western Peri- odicals, No. Hollywood, Calif.	<b>SUBMANAUT</b> Report of Survey by Capt . C. (Martine) Holland, Miami, Fla., of 16 Aug. 1968
<b>STAR I</b>	Underwater Development Engineering Research and Development Department, Gen. Dynamics Corp., 1966 Underwater Equipment Availability. (Technical de- scriptions of all Gen. Dyn. produced submersibles)	<b>SUBMARAY</b> Fact sheets from Hydrotech Co., Long Beach, Calif.
<b>SUBMANAUT (Helle)</b>	J.R. Helle, Oceanic Enter- prises, San Diego, Calif., (Re- sponse to ICMAREF ques-	<b>SURV</b> Lintott Engineering Ltd., Horsham, Sussex, England Technical Description of <b>SURV</b> . Standard Underwater Research Vehicle
		<b>TOURS 64 &amp; 66</b> Personal communication with P. Kayser of Maschinenbau Gabler GmbH, Lubeck, Fed- eral Republic of West Ger- many

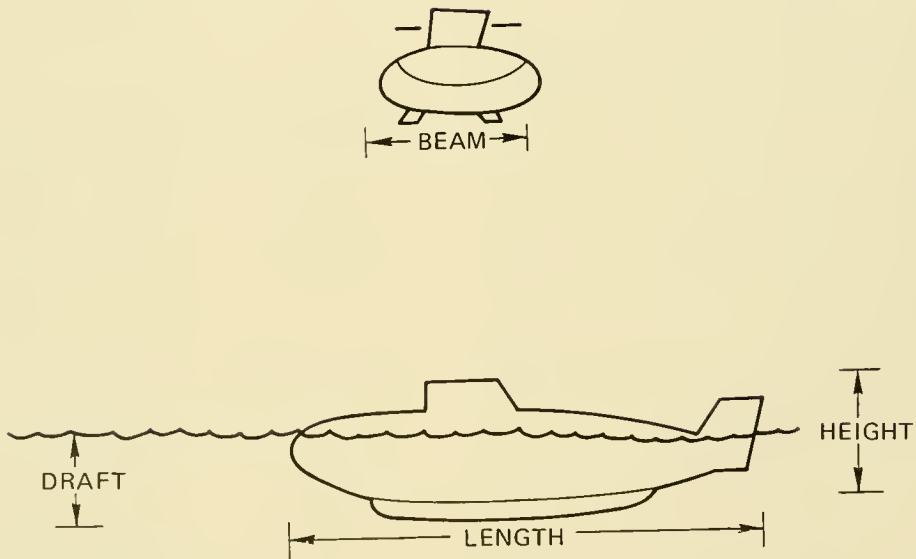

Fig 4 1 Submersible dimensions



**TABLE 4.1 SUBMERSIBLES – PAST, PRESENT, FUTURE  
(AUGUST 1975)**

	Builder	Owner	Year Launched	Operating Depth (ft)	Crew	Status
ALUMINAUT	Gen. Dynamics Groton, Conn.	Reynolds International Richmond, Va.	1964	15,000	6	Inactive
ALVIN AQUARIUS I	General Mills Inc. HYCO Vancouver, B.C.	U.S. Navy	1964	12,000	3	Operational
ARCHIMEDE	French Navy	P & O Intersubs French Navy Toulon	1973 1961	1,200 36,000	3 3	Operational: 1 Under construction: 2 Operational
ARGYRONETE	Center for Advanced Marine Studies (CEMA)	CNEXO Paris	—	1,970	10	Construction Halted in 1971
ASHERAH	Gen. Dynamics Groton, Conn.	Technoceans New York City	1964	600	2	Inactive
AUGUSTE PICCARD	Giovanola Bros. Monthey, Switzerland	Horton Maritime Expl. Vancouver, B.C.	1963	2,500	*	Operational by January 1976  *Has carried 45 people
BEAVER	North Amer. Rockwell Seal Beach, Ca.	International Underwater Contractors, New York City	1968	2,000	4	Operational
BEN FRANKLIN	Giovanola Bros. Monthey, Switzerland	Horton Maritime Expl. Vancouver, B.C.	1968	2,000	6	Not operating
BENTHOS V	Lear Siegler, Inc. Deep River, Conn.	Garrison 8 Divers Seattle, Wash.	1963	600	2	Not Operating
CHIHIRO	Kawasaki Heavy Ind. Tokyo	Japanese Government	1975	164	6	Experimental Rescue Vehicle
DEEP DIVER	Perry Submarine Riviera Beach, Fla.	Marine Sciences Ctr. Ft. Pierce, Fla.	1968	1,350	4	On Display in Miami, Florida
DEEP JEEP	U.S. Naval Ord. Test Sta., China Lake, Ca.	Scripps Inst. Ocean. La Jolla, Ca.	1964	2,000	2	Scrapped
DEEP QUEST	Lockheed Missiles & Space Corp. Sunnyvale, Ca.	Lockheed Missiles & Space Corp. Sunnyvale, Ca.	1967	8,000	4	Operational
DEEP SIX	Deep Six Mar. Services Miami, Fla.	Unknown	1969	150	3	Playground Display
DEEPSTAR 2000	Westinghouse Elec. Corp.	Westinghouse Ocn. Res. & Eng. Ctr. Annapolis, Md.	1969	2,000	3	Not Operating
DEEPSTAR 4000	Westinghouse Elec. Corp.	COMEX Marseilles	1965	4,000	3	Undergoing refit
DEEPSTAR 20000	Westinghouse Elec. Corp.	Westinghouse Ocn. Res. & Eng. Ctr. Annapolis, Md.	—	20,000	3	Construction Halted in 1970 Under control of Southwest Res. Lab.
DEEP VIEW DOWB	U.S. Navy Gen. Mtrs. Corp. Santa Barbara, Ca.	U.S. Navy Friendship, S.A. Miami, Fla.	1971 1968	2,000 4,500	2 3	Undergoing Refit Undergoing refit
DSRV-1 & 2	Lockheed Missiles & Space Corp. Sunnyvale, Ca.	U.S. Navy	1970; 1971	3,500; 5,000	27	Undergoing sea trials.
FNRS-2	Auguste Piccard Lausanne, Switzerland	French Navy	1948	13,500	2	Not Operating

TABLE 4.1 SUBMERSIBLES – PAST, PRESENT, FUTURE (CONT.)

	Builder	Owner	Year Launched	Operating Depth (ft)	Crew	Status
FNRS-3	French Navy	French Navy	1953	13,500	2	Reconfigured from FNRS-2. Retired in 1960
GLDBULE	—	COMEX Marseilles	—	660	—	Operational
GOLOFISH	Burt Dickman Auburn, Ind.	Unknown	1958	100	5	Status unknown, sold in 1973
GRIFFON	French Naval & Construction yard Brest	French Navy	1973	1,970	3	Undergoing sea trials as of Feb. 1974
GUPPY	Sun Shipbuilding & Dry Dock Co. Chester, Pa.	Sun Shipbuilding & Dry Dock Co. Chester, Pa.	1970	1,000	2	Inactive
HAKUGEI	Heiwa Kosakusho Osaka, Japan	Tokai Salunge Co. Toba, Japan	1961	656	6	Tethered Inactive
HAKUYO	Kawasaki Heavy Ind. Tokyo	Sumitomo Shoji Kaisha, Ltd. Tokyo	1971	984	4	Operational
HIKINO	U.S. Naval Weapons Center China Lake, Ca.	U.S. Naval Weapons Center China Lake, Ca.	1966	20	2	Not Operating; Experimental
JIM	Underwater Marine Equip. Ltd. Farnborough, Hants, England	Oceaneering International Houston, Tx	1973	1,300	1	A pressure-resistant diving suit; Undergoing sea trials. Has been to 440 feet.
JOHNSON SEA LINK	Aluminum Co. of America (ALCOA)	Harbor Branch Foundation Ft. Pierce, Fla.	1971	1,000	4	A second vehicle will be completed in 1976.
K-250	G. W. Kittredge Warren, Me	Various	1966	250	1	unknown
KUMUKAHI	Oceanic Institute Makapuu, Hawaii	Oceanic Institute Waimanalo, Hawaii	1969	300	2	On display
KUROSHIO I	Japan Steel & Tube Corp. Tokyo	Univ. of Hokkaido Hokkaido, Japan	1951	650	3	Retired in 1960
KUROSHIO II	Japan Steel & Tube Corp. Tokyo	Univ. of Hokkaido Hokkaido, Japan	1960	650	4	Not Operating
MAKAKAI	U.S. Navy	U.S. Navy	1971	600	2	Not Operating
MERMAID I/II	Bruker-Physik, A.G. Karlsruhe, West Ger.	International Underwater Contractors New York City	1972	984	2	Operational
MERMAID III/IV	Bruker-Physik, A.G. Karlsruhe, West Ger.	Bruker-Physik, A.G. Karlsruhe, West Ger.	1974	656	4	To be operational by 1976
MINI DIVER	Great Lakes Underwater Sports Elmwood Park, Ill.	Same	1968	250	2	Not Operating
MOANA I	—	COMEX Marseilles	—	1,320	—	Operational
MOANA II	—	COMEX Marseilles	—	1,320	—	Operational
NAUTILETTE	Nautilette Inc. Ft. Wayne, Ind.	Mr. D. Haight Warrens ville, Ill.	ca. 1964	100	1	Operational
NAUTILETTE	Nautilette Inc. Ft. Wayne, Ind.	Nautilette Inc. & Mr. C. Russner, Nashville, Mich.	ca. 1964	100	2	Both vehicles operational
NEKTON A, B, C	Nekton, Inc. San Diego, Ca.	General Oceanographics San Diego, Ca.	1968, 1970, 1971	1,000	2	All three vehicles operational

TABLE 4.1 SUBMERSIBLES – PAST, PRESENT, FUTURE (CONT.)

	Builder	Owner	Year Launched	Operating Depth (ft)	Crew	Status
NEMO						
	U.S. Navy	U.S. Navy	1970	600	2	Operated by Southwest Research Inst.
NEREID 330	Nereid nv. Schiedam, Holland	Dutch Submarine Services, Amsterdam	1972	330	3	Operational
NEREID 700	Nereid nv. Schiedam, Holland	Dutch Submarine Services, Amsterdam	—	700	4	Due to be launched in 1976
NR-1	Gen. Dyn. Corp. Groton, Conn.	U.S. Navy	1969	NA	7	Operational
OPSUB	Perry Sub. Builders Riviera Beach, Fla.	Ocean Sys., Inc. Reston, Va.	1972	2,000	2	Inactive
PAULO I	Anautics Inc. San Diego, Ca.	Same	1967	600	2	Reconfigured to SEA OTTER
PC-3A (1&2)	Perry Sub. Builders Riviera Beach, Fla.	U.S. Air Force U.S. Army	1964 1966	300	2	Retired in 1975
PC-3B (TECH DIVER)	Perry Sub. Builders Riviera Beach, Fla.	International Underwater Contractors NYC, New York	1963	600	2	Not Operating
PC3-X	Perry Sub. Builders Riviera Beach, Fla.	Univ. of Texas Austin, Tx.	1962	150	2	Operational (dives occasionally)
PC5C	Perry Sub. Builders Riviera Beach, Fla.	Sub Sea Oil Services, SPA Milan, Italy	1968	1,200	3	Undergoing refit (August 1974)
PC-8B	Perry Sub. Builders Riviera Beach, Fla.	Northern Offshore Ltd. London	1971	800	2	Operational
PC-1201	Perry Sub. Builders Riviera Beach, Fla.	Northern Offshore Ltd London	1975	1,000	2	Operational
PC-1202	Perry Sub. Builders Riviera Beach, Fla.	Northern Offshore Ltd. London	1975	1,000	5	Operational
PC-1401	Perry Sub. Builders Riviera Beach, Fla.	Texas A & M Univ. College Station, Tx.	1974	1,200	2	Operational
PC-1402	Perry Sub. Builders Riviera Beach, Fla.	U.S. Army	1975	1,200	2	Operational
PC-16	Perry Sub. Builders Riviera Beach, Fla.	Northern Offshore Ltd. London	—	3,000	3	Under Construction
PHOENIX 66	Sub Sea Oil Services SPA Milan, Italy	Same	—	1,200	7	Under construction
PISCES I	HYCO Vancouver, B.C.	Vickers Oceanics Ltd. Barrow-in-Furness, Eng.	1965	1,200	2	Operational
PISCES II	HYCO Vancouver, B.C.	Vickers Oceanics Ltd. Barrow-in-Furness	1968	2,600	3	Operational
PISCES III	HYCO Vancouver, B.C.	Vickers Oceanics Ltd. Barrow-in-Furness	1969	3,600	3	Operational
PISCES IV	HYCO Vancouver, B.C.	Dept. of Environment Victoria, B.C.	1971	6,500	3	Operational
PISCES V	HYCO Vancouver, B.C.	P & O Intersubs Vancouver, B.C.	1973	6,500	3	Operational
PISCES VI	HYCO Vancouver, B.C.	Soviet Acad. Sciences Moscow	1975	6,500	3	Operational
PISCES VII	HYCO Vancouver, B.C.	Soviet Acad. Sciences Moscow	—	6,500	3	Under Construction
PISCES VIII	HYCO Vancouver, B.C.	Vickers Oceanics Ltd. Barrow-in-Furness	—	6,500	3	Operational
PISCES X	HYCO Vancouver, B.C.	HYCO Subsea, Ltd. Vancouver, B.C.	—	6,500	3	Under Construction
PISCES XI	HYCO Vancouver, B.C.	Vickers Oceanics, Ltd. Barrow-in-Furness	—	6,500	3	Under Construction

TABLE 4.1 SUBMERSIBLES – PAST, PRESENT, FUTURE (CONT.)

	Builder	Owner	Year Launched	Operating Depth (ft)	Crew	Status
PORPOISE	Unknown	Pacific Sub. Co. Seattle, Wash.	1970	150	1	A class of recreational submersibles made in West Germany and sold in the U.S.
PRV-2	Pierce Submersibles Bay Shore, N.Y.	Same	—	600	3	Under Construction
PS-2	Perry Sub. Builders Riviera Beach, Fla.	Sub Sea Oil Services SPA Milan, Italy	1972	1,025	2	Operational
QUESTER 1	Deep Sea Techniques Brooklyn, N.Y.	Same	1972	650	2	Inactive
SDL-1	HYCO Vancouver, B.C.	Canadian Forces Halifax, Nova Scotia	1970	2,000	6	Operational
SEA CLIFF	Gen. Dynamics Groton, Conn.	U.S. Navy	1968	6,500	3	Operational
SEA EXPLORER	Sea Line Inc. Brier, Wash.	Same		600	2	
SEA DITTER	Anautics Inc. San Diego, Ca.	Candive Ltd. Vancouver, B.C.	1971	1,500	3	Operational
SEA RANGER	Verne Engineering Mt. Clemens, Mich.	Same	1972	600	4	Operational
SEA-RAY	Submarine Res. & Dev. Corp. Lynnwood, Wash.	Same	1968	1,000	2	Operating
SHELF DIVER	Perry Sub. Builders Riviera Beach, Fla.	Unknown	1968	800	4	Operational under Inter-Sub, Marseilles
SHINKAI	Kawasaki Heavy Ind. Kobe, Japan	Japanese Maritime Safety Agency Tokyo	1968	1,968	4	Operational
SNOOPER	Sea Graphics Inc. Torrance, Ca.	Same	1969	1,000	2	Operational
SP-350	Office Francais de Recherches Sous-Marine Marseilles	Campagnes Oceanogra- phique Francaises (COF) Monaco	1959	1,350	2	Operational
SP-500	Sud Aviation France	COF Monaco	1969	1,640	1	
SP-3000	Centre de l'Etudes Mar- ine Avancees (CEMA) Marseilles	CNEXO Paris	1970	10,082	3	Operational
SPORTSMAN 300	American Sub. Co. Lorain, Ohio	Various	1961	300	2	Unknown
SPORTSMAN 600	American Sub. Co. Lorain, Ohio	Various	1963	600	2	Unknown
STAR I	Gen. Dynamics Groton, Conn.	Phila. Maritime Mues. Phila. Pa.	1963	200	1	On display
STAR II	Gen. Dynamics Groton, Conn.	Same	1966	1,200	2	Operational
STAR III	Gen. Dynamics Groton, Conn.	Scripps Inst. of Oceanog. LaJolla, Ca.	1966	2,000	2	Not Operating

TABLE 4.1 SUBMERSIBLES – PAST, PRESENT, FUTURE (CONT.)

	Builder	Owner	Year Launched	Operating Depth (ft)	Crew	Status
SUBMANAUT (Helle)	Helle Engineering San Diego	Same	1963	200	2	Not Operating
SUBMANAUT (Martine)	Martine's Diving Bells San Diego, Ca.	Submarine Services Coral Gables, Fla.	1956	600	6	Not Operating
SUBMARAY	C & D Tools Calif.	Kinautics Inc. Winchester, Mass.	1962	300	2	Scrapped
SURV	Lintott Engineering Ltd. Horsham, Sussex, Eng.	Same	1967	600	2	Scrapped
TADPOLE-1	Mitsui Shipbuilding & Engineering Co. Ltd. Tokyo	Mitsui Ocn. Development & Engineering Co. Ltd. Tokyo	1972	328	2	Tethered Inactive
TAURUS	HYCO Vancouver, B.C.	P & O Intersubs Montrose, Scotland	–	2,000	NA	Under Construction
TOKAI	Heiwa Kosakusho Osaka, Japan	Tokai Salvage Co. Toba, Japan	1954	656	2	Tethered Inactive
TOURS 64	Maschinenbau Gabler GmbH West Germany	Kuofeng Ocean Dev. Corp. Taipei, Taiwan	1971	984	2	Operational
TOURS 66	Maschinenbau Gabler GmbH West Germany	Sarda Estracione Lav- orazione Cagliari, Sardinia	1972	984	2	Operational
TRIESTE I	Auguste Piccard in Trieste, Italy	U.S. Navy	1953	36,000	3	Retired. On display
TRIESTE II	Mare Island Shipyard Mare Island, Ca.	U.S. Navy	1964	20,000	3	Operational
TS-1 (SURVEY SUB 1)	Perry Sub. Builders Riviera Beach, Fla.	P & O Subsea (UK), Ltd. London	1970	1,350	3	Operational
TURTLE	Gen. Dynamics Groton, Conn.	U.S. Navy	1968	6,500	3	Operational
URF	Kockums Malmo, Sweden	Swedish Navy	–	1,510	25	Under Construction.
UZUSHIO	Nippon Kokankk Tokyo	Same	1973	658	2	Rescue sub. Tethered Inactive
VASSENA LECCO	Mr. G. Vassena Torino, Italy	Same	1948	1,335	2	Sunk
VIPER FISH	Mr. Don Taylor Atlanta, Ga.	Same	1969	1,000	2	Unknown
VOL-L 1	Perry Sub. Builders Riviera Beach, Fla.	Vickers Oceanics Ltd. Barrow-in-Furness	1973	1,200	4	Operational
YOMIURI	Mitsubishi Heavy Ind. Kobe, Japan	Yomiuri Shimbu News- paper Tokyo	1964	972	6	Scrapped
unnamed	P. Dostal & C. Hair Alvin, Tx.	Same	–	600	2	Under Construction
unnamed	Charles Yuen Sub. Hong Kong	All Ocean Industries Houston, Tx.	1971	150	2	Not Operating
unnamed	Robb Engineering Amherst, Nova Scotia	Island Divers Assoc. Seal Cove, New Brunswick	1970	600	1	Unknown











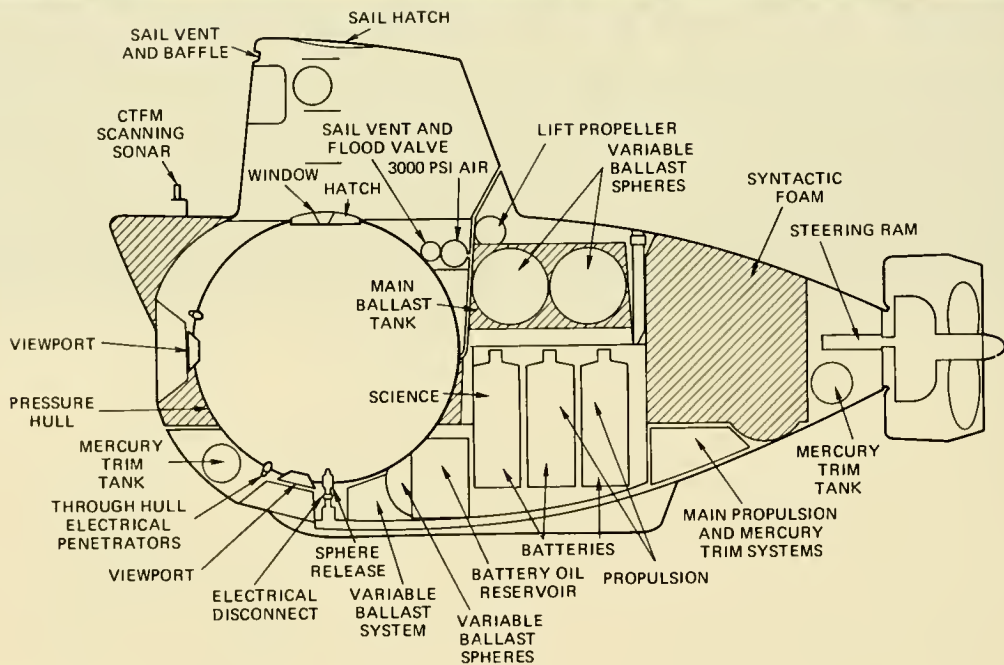

## ALVIN

LENGTH: ..... 25 ft  
 BEAM: ..... 8 ft  
 HEIGHT: ..... 13 ft  
 DRAFT: ..... 7½ ft  
 WEIGHT (DRY): ..... 16¾ tons  
 OPERATING DEPTH: ..... 12,000 ft  
 COLLAPSE DEPTH: ..... 18,000 ft  
 LAUNCH DATE: ..... 1964

HATCH DIAMETER: ..... 19 in.  
 LIFE SUPPORT (MAX): ..... 216 man-hr  
 TOTAL POWER: ..... 40½ kWh  
 SPEED (KNOTS): CRUISE ..... 1/8 hr  
                           MAX ..... 2/2 hr  
 CREW: PILOTS ..... 1  
           OBSERVERS ..... 2  
 PAYLOAD: ..... 1,000 lb

**PRESSURE HULL:** Spherical shape. Composed of Navy 621.0B titanium, 7-ft OD, 1.97 in. thick to 2½ in. at inserts.

**BALLAST/BUOYANCY:** MBT's provide 1,500 lbs of surface buoyancy. VBT's consist of hard tanks and pump operable to 12,000 ft. Syntactic foam provides approximately 4,000 lb of positive buoyancy. A 250-lb weight is carried to decrease descent time; it is dropped at the bottom; another 250-lb weight is dropped for ascent.

**PROPULSION/CONTROL:** Main propulsion is from a 10-hp hydraulic motor driving a 50-in.-diam. propeller trainable 50° left or right. Thrusters are located amidships which are powered by 6-hp hydraulic motors and are rotatable 360° in the vertical plane.

**TRIM:** Bow angles of ±10° are obtained by transferring 450 lb of mercury forward or aft.

**POWER SOURCE:** Three, pressure-compensated boxes of lead-acid batteries. Two boxes supply 30 V, the third supplies 60 V. Four 4-amp-hr nickel-cadmium batteries supply emergency power.

**LIFE SUPPORT:** Gaseous O<sub>2</sub> in pressure hull. LiOH is used to remove CO<sub>2</sub>. O<sub>2</sub> and CO<sub>2</sub> monitors.

**VIEWING:** Four large viewports forward; these are 3½ in. thick, 5-in. ID and 12-in. OD. A smaller viewport is in the hatch cover which is 2 in. thick, 2-in. ID and 6-in. OD.

**OPERATING/SCIENTIFIC EQUIPMENT:** UDC with transponder interrogator. Four pressure depth gages, up/down echo sounder, TV, pinger, current meter, CTFM sonar, gyrocompass, two-35-mm still cameras, one 8-mm & one 16-mm cine cameras.

**MANIPULATORS:** One with six degrees of freedom.

**SAFETY FEATURES:** Manipulator, batteries (3,400 lb) and specimen basket are attainable. Pressure sphere releasable (2,000 lb of positive buoyancy). Closed circuit emergency breathing off normal O<sub>2</sub> supply. Distress rockets and flares, strobe lights, life vests, radio homing beacon.

**SURFACE SUPPORT:** Supported by the catamaran LULU, 105 ft LOA, 48-ft beam, 12-ft draft, 450-ton displacement, max. speed 6 knots, propulsion from three 200-hp outboard motors. Seventeen people constitute the system's crew.

**OWNER:** U.S. Navy-owned. Operated by Woods Hole Oceanographic Institution, Woods Hole, Mass.

**BUILDER:** General Mills/Litton Industries, Minneapolis, Minn.

**REMARKS:** Steel pressure hull replaced by titanium hull in 1973; thereby increasing depth range from 6,000 to 12,000 ft.

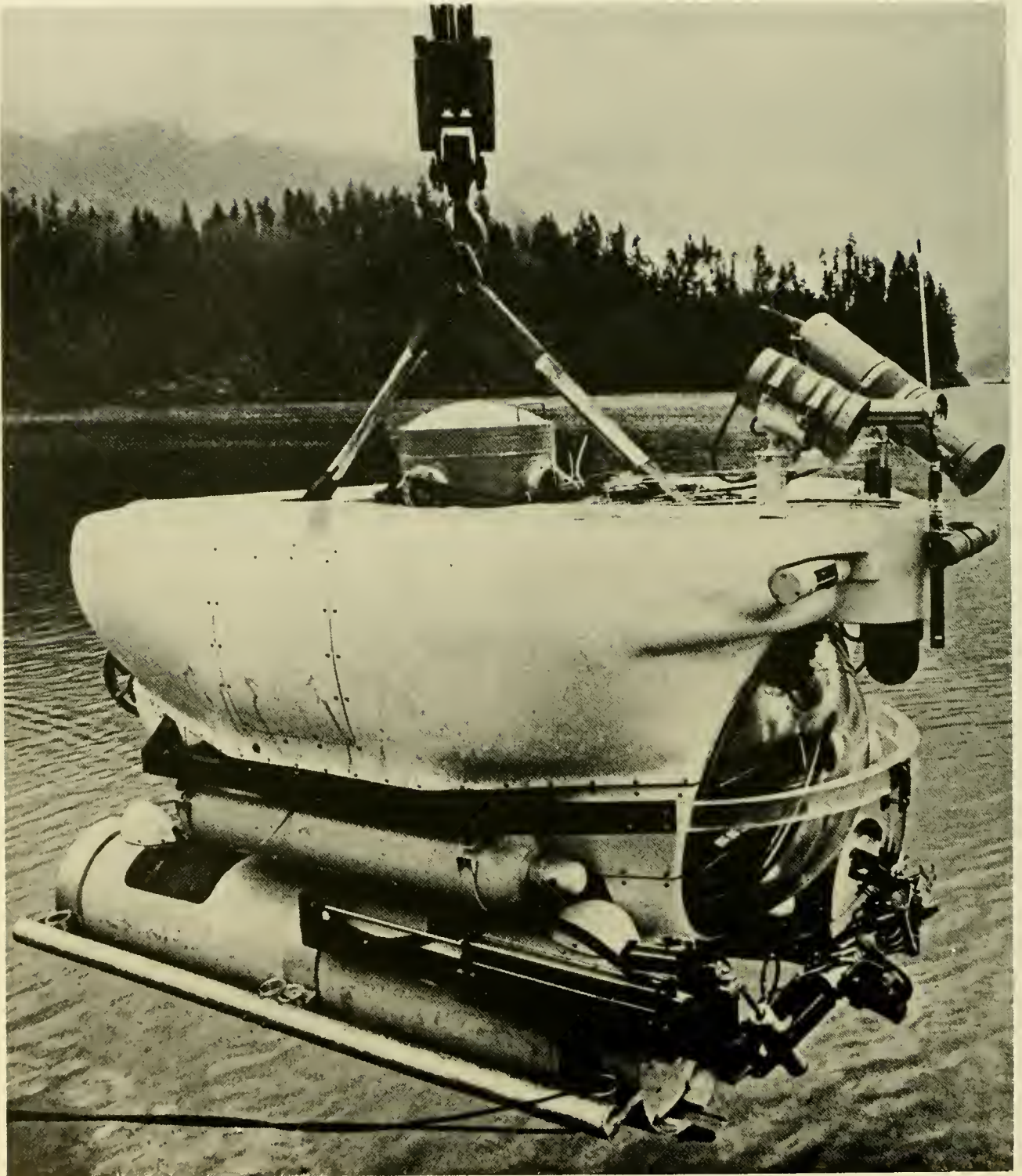

## AQUARIUS I

LENGTH: ..... 13½ ft  
BEAM: ..... 6 ft  
HEIGHT: ..... 6¾ ft  
DRAFT: ..... 5½ ft  
WEIGHT (DRY): ..... 4½ tons  
OPERATING DEPTH: ..... 1,200 ft  
COLLAPSE DEPTH: ..... NA  
LAUNCH DATE: ..... 1973

HATCH DIAMETER: ..... 19 in.  
LIFE SUPPORT (MAX): ..... 108 man-hr  
TOTAL POWER: ..... NA  
SPEED (KNOTS): CRUISE ..... NA  
MAX ..... 3  
CREW: PILOTS ..... 1  
OBSERVERS ..... 2  
PAYLOAD: ..... 1,100 lb

**PRESSURE HULL:** Cylindrical shape of A516 grade 70 steel, 46-in. diam., 105 in. long.

**BALLAST/BUOYANCY:** Main ballast is from fore/aft mounted fiberglass tanks which are vented or blown dry to provide negative or positive buoyancy, respectively. A low pressure surface buoyancy system is provided to obtain reserve buoyancy.

**PROPULSION/CONTROL:** Lateral movement is provided through a stern-mounted, reversible propeller capable of training 90° port or starboard and powered by a pressure-compensated 5-hp motor. Vertical underway control is by port/starboard bow planes mounted forward and above the bow viewing dome.

**TRIM:** Up/down bow angles can be controlled by bow planes. Two fore and aft fiberglass tanks, subdivided at centerline, can be filled with ambient seawater or blown dry collectively or individually to provide both ballast and trim.

**POWER SOURCE:** Lead-acid batteries contained in pressure-resistant cylinders (20-in. diam., 96 in. long) of the same material as the pressure hull are connected to provide a nominal voltage of 120 V at 225 amp-hr. A 15-V nickel-cadmium battery inside the pressure hull provides emergency power.

**LIFE SUPPORT:** O<sub>2</sub> is carried in two 70-SCF (nominal) tanks. CO<sub>2</sub> is removed by LiOH canisters.

**VIEWING:** One 39-in.-diam., acrylic plastic (grade G plexiglass) dome in forward end of pressure hull. Smaller viewports are elsewhere on conning tower and hatch.

**OPERATING/SCIENTIFIC EQUIPMENT:** UQC, scanning sonar, depth gage, compass.

**MANIPULATORS:** One with six degrees of freedom.

**SAFETY FEATURES:** Jettisonable propulsion unit and manipulator claw. Emergency power (15-V Ni-Cad battery) in pressure hull. Self-contained O<sub>2</sub> rebreathers. Manually droppable weight. Life vests, dry chemical fire extinguishers and flashlights.

**SURFACE/ShORE SUPPORT:** SOO.

**OWNER:** International Hydrodynamics, Inc., Vancouver, B.C.

**BUILDER:** Same as above.

**REMARKS:** Operational.

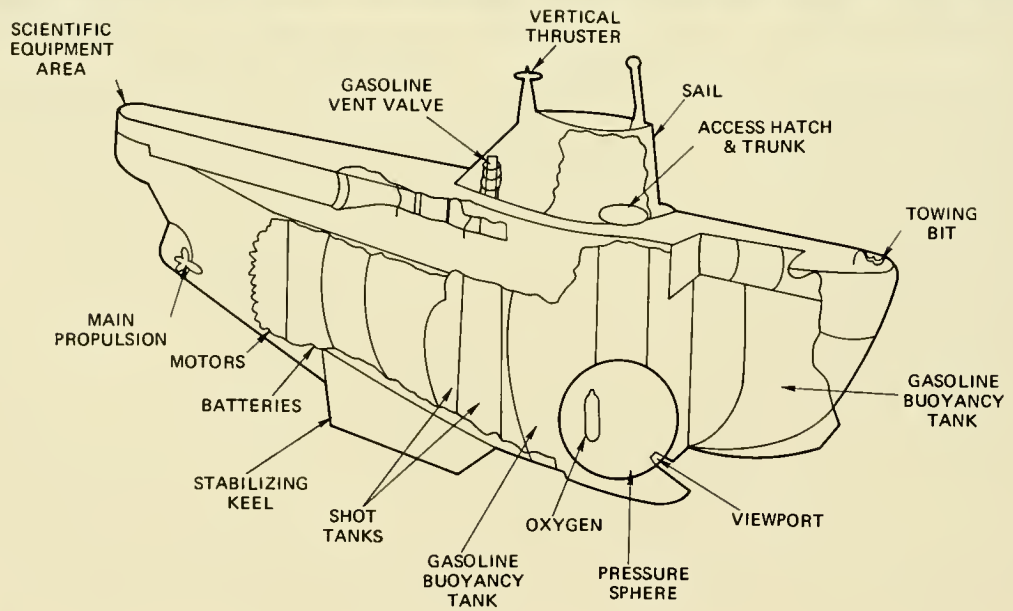
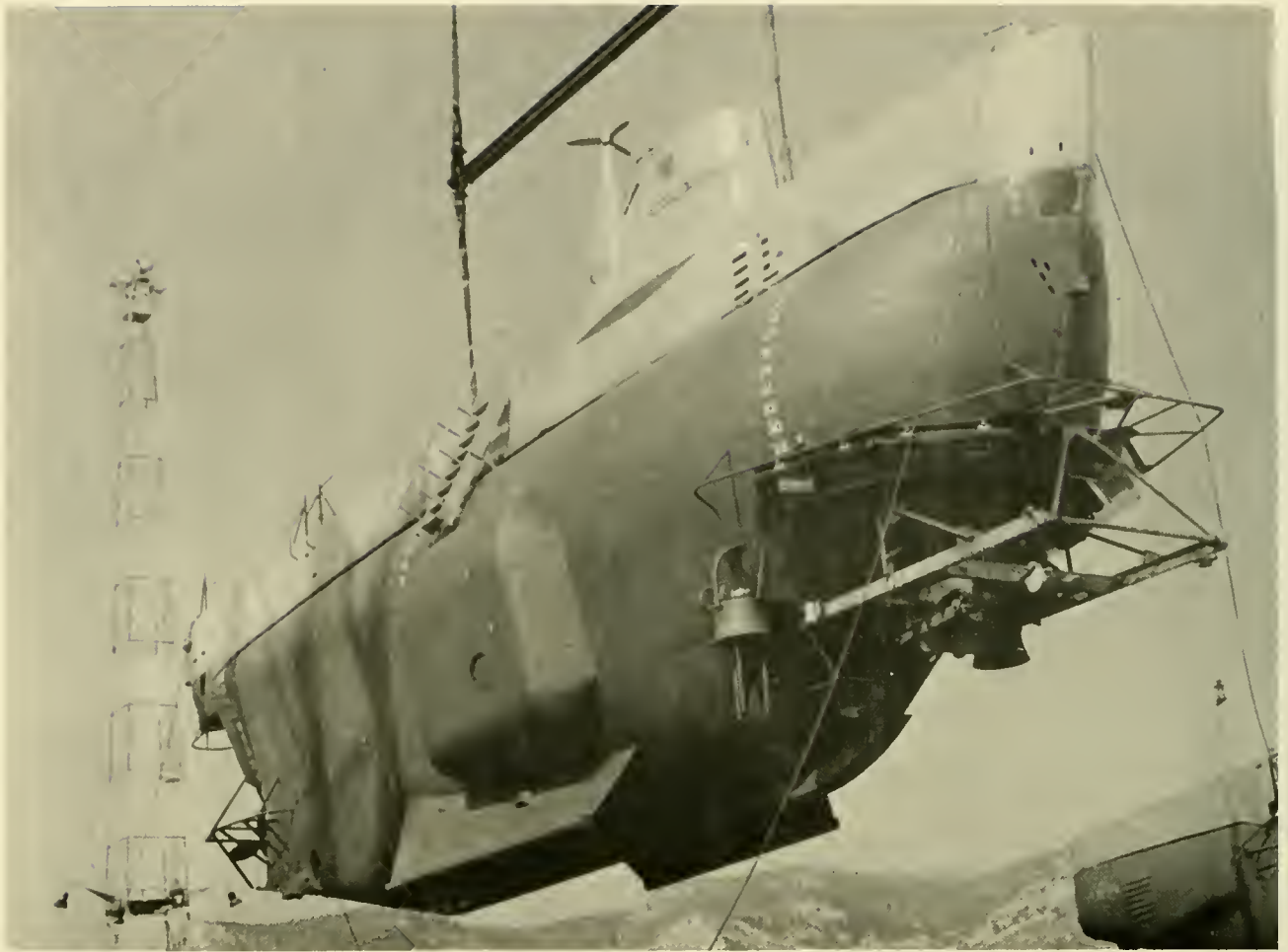

## ARCHIMEDE

LENGTH: ..... 69 ft  
BEAM: ..... 13 ft  
HEIGHT: ..... 26½ ft  
DRAFT: ..... 17.1 ft  
WEIGHT (DRY): ..... 61 tons  
OPERATING DEPTH: ..... 36,000 ft  
COLLAPSE DEPTH: ..... 100,000 ft  
LAUNCH DATE: ..... 1961

HATCH DIAMETER: ..... 17.7 in.  
LIFE SUPPORT (MAX): ..... 108 man-hr  
TOTAL POWER: ..... 100 kWh  
SPEED (KNOTS): CRUISE ..... ½/10 hr  
MAX ..... 2¾/3 hr  
CREW: PILOTS ..... 1  
OBSERVERS ..... 2  
PAYLOAD: ..... 6,000 lb

**PRESSURE HULL:** Spherical shape. Two, bolted hemispheres of Ni-Cr-Mo steel 5.9 in. thick, 6-ft 7-in. ID. Total weight is approximately 15 tons.

**BALLAST/BUOYANCY:** Positive buoyancy is provided by 45,000 gal of hexane within a thin, iron alloy float. Iron shot (16½ tons) is released to ascend. A 26-ft-long, 132-lb cable is dragged on the bottom for fine buoyancy control.

**PROPULSION/CONTROL:** Main propulsion is from a reversible, 20-hp motor. A horizontal and vertical thruster of 5 hp each are mounted forward and topside, respectively.

**TRIM:** No systems available.

**POWER SOURCE:** Lead-acid batteries, externally located: Two 24-V, 160-amp-hr; one 28-V, 52-amp-hr; one 110-V, 860-amp-hr.

**LIFE SUPPORT:** Four O<sub>2</sub> tanks at 150 kg/cm<sup>2</sup> pressure. CO<sub>2</sub> removed by two soda lime cannisters. Silica gel used to reduce humidity.

**VIEWING:** Three plastic viewports. One is on the longitudinal plane of symmetry; two are on each side and look forward and down at 20° from the horizontal. Viewports are 44 mm thick, 110-mm OD, 21-mm ID. A binocular telescope in each viewport produces a 58° field of view.

**OPERATING/SCIENTIFIC EQUIPMENT:** Vertical/horizontal speed monitor, deep (0–36,000 ft) and shallow (0–1,200 ft) echo sounders, obstacle avoidance sonar, UQC, TV, three 35-mm still cameras, temperature (water) sensor, gyrocompass, sound velocimeter, pH meter, differential pressure gage. Environmental data is recorded on magnetic tape at 10-sec intervals.

**MANIPULATORS:** One mounted forward of the pressure sphere capable of 5-ft extension, 200-lb lift.

**SAFETY FEATURES:** Iron shot automatically dropped in the event of power failure. An extra 5.5 tons of iron/lead ballast is carried which may be dropped to compensate for leak in sphere or in largest hexane tank. Closed circuit O<sub>2</sub> rebreathers are carried for each occupant of sphere.

**SURFACE SUPPORT:** Towed to dive site.

**OWNER:** Owned by French Navy, operated by Centre National Pour L'Exploitation des Oceans (CNEXO), Toulon.

**BUILDER:** Frency Navy.

**REMARKS:** Operational. This is presently the world's deepest-diving vehicle.

## ARGYRONETE

LENGTH: ..... 27.8 m  
 BEAM: ..... 6.8 m  
 HEIGHT: ..... 8.5 m  
 DRAFT: ..... NA  
 WEIGHT (DRY): ..... 282.2 tons  
 OPERATING DEPTH: ..... 1,970 ft  
 COLLAPSE DEPTH: ..... 3,800 ft  
 LAUNCH DATE: ..... Not completed

HATCH DIAMETER: ..... 1.2 m  
 LIFE SUPPORT (MAX) ..... 1,920 man-hr  
 TOTAL POWER: ..... 1,200 kWh  
 SPEED (KNOTS): CRUISE ..... NA  
                   MAX ..... 4  
 CREW: PILOTS ..... 4  
       OBSERVERS ..... 6  
 PAYLOAD: ..... NA

**PRESSURE HULL:** Two cylindrical hulls with hemispherical endcaps; one for atmospheric pressure, one for ambient pressure. Both hulls are made of 30-mm-thick, high yield-strength (SMR-type) steel. Atmospheric hull is 16.2 m long, 3.7-m diam.; ambient pressure hull is 5 m long, 2.5-m diam. Hulls are linked by two spherical lock-out chambers 1.50-m diam.

**BALLAST/BUOYANCY:** Two 1,250-l-capacity tanks forward and two 1,650-l tanks aft supply main ballast. Two tanks of 1,120-l capacity for trim and two tanks of 1,500-l capacity for equalizing submersible displacement when carrying extra equipment.

**PROPULSION/CONTROL:** Surface and submerged propulsion is supplied by two Kort nozzles each driven by a hydraulic pump supplying 75 hp at 330 rpm. The nozzles rotate around a vertical shaft and facilitate normal underway maneuvering. Slow speed maneuvering is attained by fore- and aft-mounted vertical and horizontal thrusters.

**TRIM:** No systems available.

**POWER SOURCE:** Surface power is supplied by a 225-hp diesel engine which accuates a 30-kW, 120-VDC auxiliary generator for shipboard power and a 72-kW, 80-120-V generator to recharge batteries. Oil-immersed, pressure-compensated, lead-acid batteries (60 ea.) of Fulmen type-L cells supply 10,000 amp-hr.

**LIFE SUPPORT:** External to the hull are the following at 250 bars pressure: Fourteen 330-l air cylinders, fourteen 330-l O<sub>2</sub> cylinders; thirteen 330-l He cylinders; one 330-l He-O<sub>2</sub> cylinder. A total of 3,500 l of fresh water can be carried in the submarine; 400 l in the underwater house. Food is prepared aboard in the main hull and can be transferred to the aft hull. A hookah system can supply air to divers.

**VIEWING:** Several viewports located in both passenger and diver hulls.

**OPERATING/SCIENTIFIC EQUIPMENT:** UQC, echo sounder, diver lock-out capability, TV cameras.

**MANIPULATORS:** None.

**SAFETY FEATURES:** A releasable steel sphere (2.25-m diam., 20 mm thick) above main hatch can carry entire crew to surface. Crew can depart vehicle through lock-out.

**SURFACE/ShORE SUPPORT:** Diesel/electric motors provide independent operations to a range of 400 nautical miles.

**OWNER:** Centre National pour l'Exploitation des Oceans/Institut Francais du Petrole.

**BUILDER:** Centre D'Etudes Marine Avancees, Marseilles.

**REMARKS:** Construction halted in 1971.

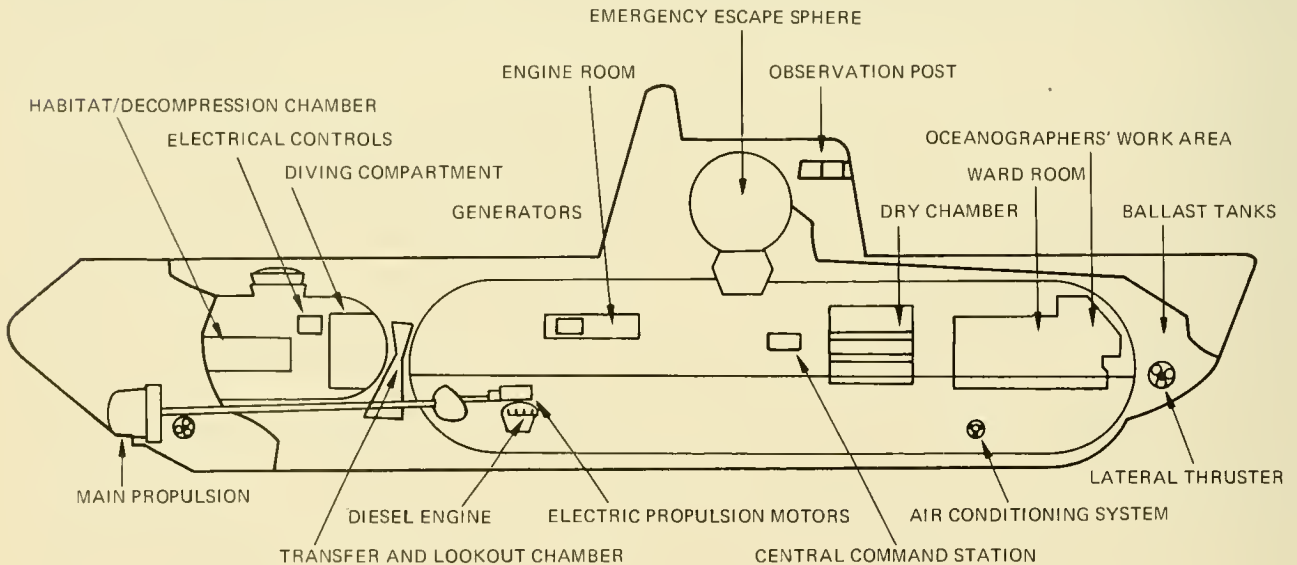



## ARIES I

LENGTH: ..... 25 1/3 ft  
 BEAM: ..... 12 ft, 1 in.  
 HEIGHT: ..... 10 ft  
 DRAFT: ..... 8 ft  
 WEIGHT (ORY): ..... 14 tons  
 OPERATING DEPTH: ..... 1,200 ft  
 COLLAPSE DEPTH: ..... NA  
 LAUNCH DATE: ..... Under construction

HATCH DIAMETER: ..... 19 in.  
 LIFE SUPPORT (MAX): ..... 108 man-hr  
 TOTAL POWER: ..... 60 kWh  
 SPEED (KNOTS): CRUISE ..... NA  
                           MAX ..... 3  
 CREW: PILOTS ..... 2  
           OBSERVERS ..... 4  
 PAYLOAD: ..... 1,100 lb

**PRESSURE HULL:** The pressure hull will be comprised of two basic elements; the submersible/diver command and control chamber, and the diver lock-out chamber fabricated from A516 grade 70 steel. All penetrators will be monel faced or 316 stainless steel.

**BALLAST/BUOYANCY:** The ballast system is comprised of "soft" and "hard" ballast tanks. The soft tanks are fabricated from fiberglass and are open at the bottom and have mechanical vents at the top. The tanks are connected to a high pressure air system so that they can be blown. The hard tanks are designed to withstand full diving depth and water is transferred between the tanks, and between the tanks and the sea by means of a salt water pump. The piping materials used in the system will be, in general, 316 stainless steel.

**PROPULSION/CONTROL:** Propulsion will be provided by three 5-hp thrusters mounted on each side and the stern of the submersible. The side thrusters will be trainable not less than 120° vertical, and the stern unit will be trainable not less than 90° port and starboard. The propulsion units will be jettisonable. The thrust output will be varied by SCR controllers, which are, in turn, controlled by a throttle.

**TRIM:** NA.

**POWER SOURCE:** The energy source will comprise a 500-amp-hr battery. The cells will be connected so that the nominal voltage will be 120 V. The battery will be located external to the command chamber in one oil-filled container.

**LIFE SUPPORT:** The life support system consists of two major elements: O<sub>2</sub> supply and CO<sub>2</sub> scrubber. The O<sub>2</sub> system consists of two 70-SCF (nominal) bottles, complete with pressure and flow regulators. The CO<sub>2</sub> removal system will consist of a motor blower assembly driving the atmosphere in the chamber through LiOH cannisters or a refillable cannister of "Soda Sorb", or equivalent. Environment monitoring equipment consists of a portable CO<sub>2</sub> and O<sub>2</sub> indicator, a barometer, thermometer and relative humidity gage.

**VIEWING:** One 39-in.-diam, plastic bow dome.

**OPERATING/SCIENTIFIC EQUIPMENT:** UQC, VHF FM radio, WESMAR scanning sonar, depth gage, compass.

**MANIPULATORS:** Three. One heavy duty and two for light work.

**SAFETY FEATURES:** The submersible will be fitted with a manually droppable weight, which will constitute the emergency ballast system. The manipulator claws and thrusters will be jettisonable using a manually operated hydraulic system operated from within the command chamber. Emergency breathing equipment will be provided in the form of self-contained rebreathers in the command sphere. Other emergency equipment includes a 15-V nickel-cadmium battery for internal emergency power, six life vests, a dry chemical fire extinguisher, six standard flashlights and a first aid kit.

**SURFACE SUPPORT:** SOO.

**OWNER:** Soviet Academy of Science, Moscow.

**BUILDER:** International Hydrodynamics Ltd., Vancouver, B.C.

**REMARKS:** Two of the vehicles are reportedly under construction. The above description is taken from the initial design, the finished vehicle may depart from this description.

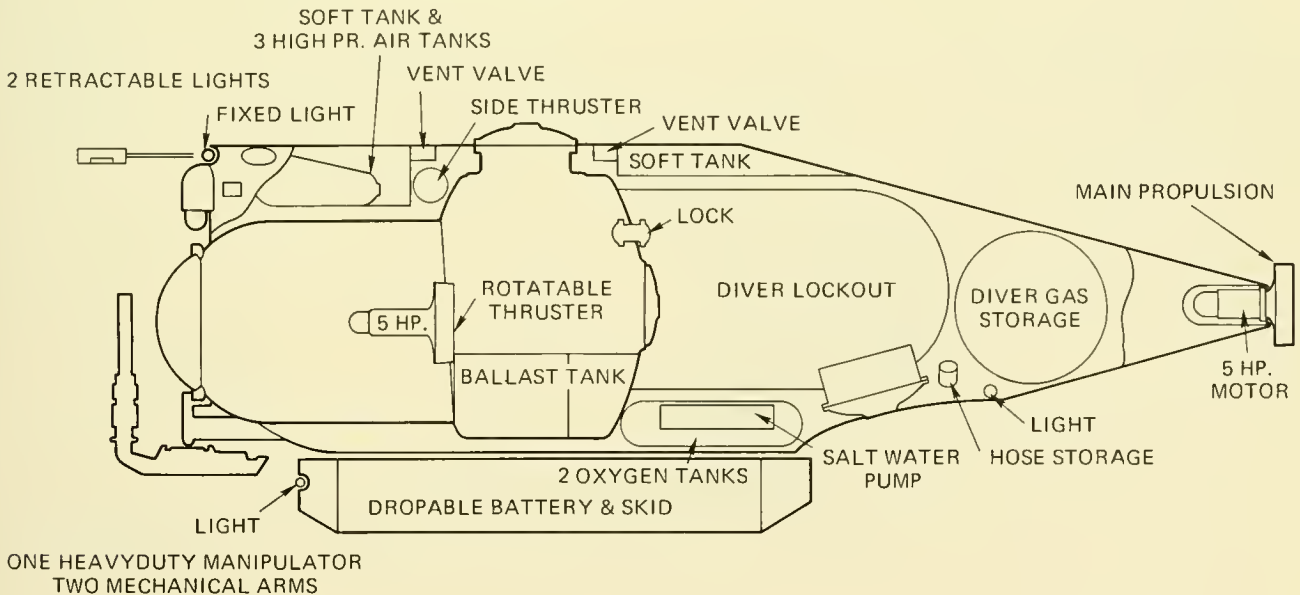

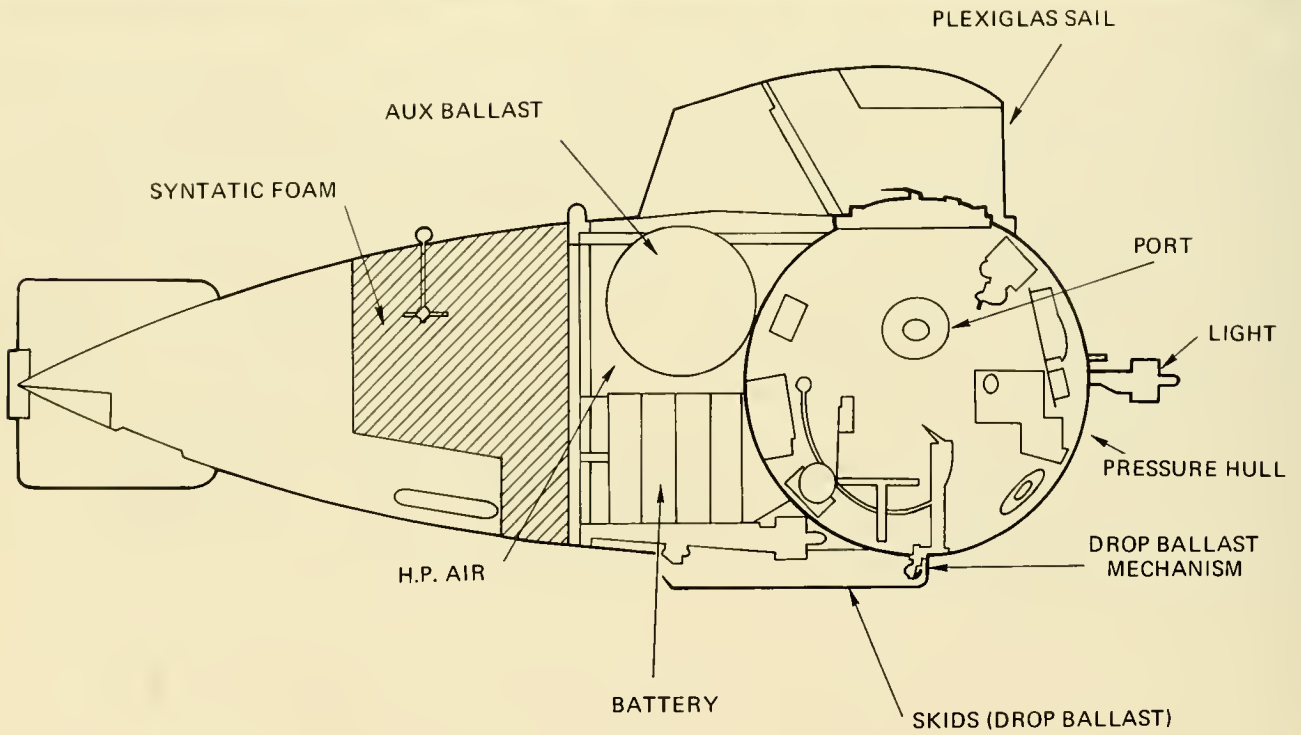
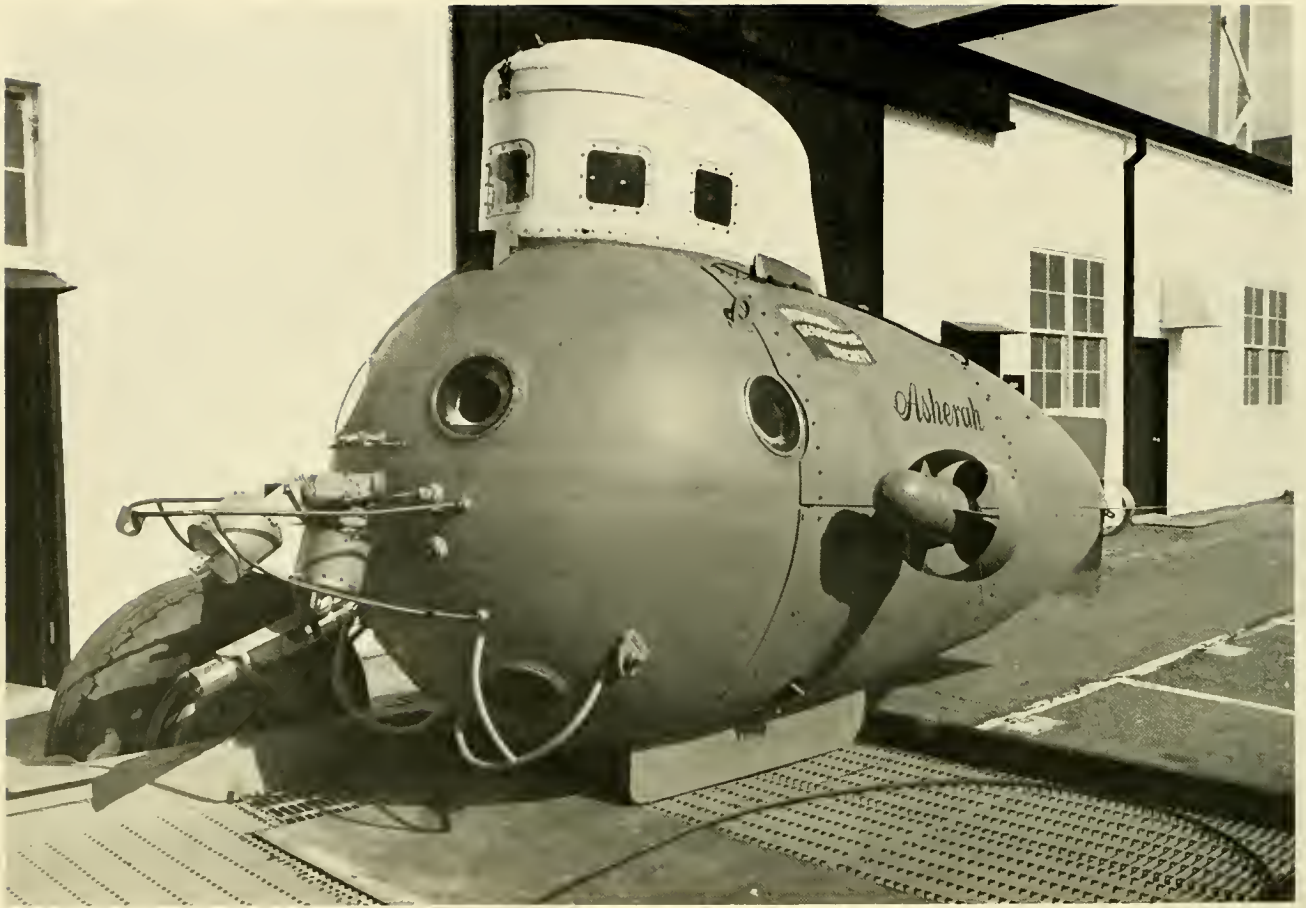

# ASHERAH

LENGTH: ..... 17 ft  
BEAM: ..... 8.6 ft  
HEIGHT: ..... 7.5 ft  
DRAFT: ..... NA  
WEIGHT (DRY): ..... 4.2 tons  
OPERATING DEPTH: ..... 600 ft  
COLLAPSE DEPTH: ..... 1,200 ft  
LAUNCH DATE: ..... 1964

HATCH DIAMETER: ..... 20 in.  
LIFE SUPPORT (MAX): ..... 48 man-hr  
TOTAL POWER: ..... 21.6 kWh  
SPEED (KNOTS): CRUISE ..... 1/8 hr  
                  MAX ..... 3/1.5 hr  
CREW: PILOTS ..... 1  
      OBSERVERS ..... 1  
PAYLOAD: ..... 100 lb

**PRESSURE HULL:** Spherical shape 5-ft ID, 5/8 in. thick of A212 grade B mild steel (firebox quality).

**BALLAST/BUOYANCY:** Main ballast air tank of 50-lb capacity provides surface buoyancy. Auxiliary ballast tank of 340-lb capacity provides fine buoyancy control submerged. High pressure air carried in external tanks (four tanks of 72 ft<sup>3</sup> STP each) pressurized at 2,250 psi. Droppable skid of 330 lb supplies additional emergency positive buoyancy.

**PROPULSION/CONTROL:** Two, infinitely variable, individually controlled 2-hp, side-mounted, rotatable and reversible thrusters.

**TRIM:** None.

**POWER SOURCE:** Externally-mounted, pressure-compensated, lead-acid batteries (Exide TSC-23-930) giving 930 amp-hr at 24 VDC.

**LIFE SUPPORT:** CO<sub>2</sub> scrubber with blower and gaseous O<sub>2</sub> carried within the pressure hull.

**VIEWING:** Six viewports, 5-in. ID; 9-in. OD, 2 in. thick and all are 90° truncated cones.

**OPERATING/SCIENTIFIC EQUIPMENT:** UQC, Magnesyn compass, Fathometer, speed indicator, directional sonar tracker, one TV camera, one 35-mm still camera.

**MANIPULATORS:** None.

**SAFETY FEATURES:** Manually releasable skids (300 lb). High pressure air blow of auxiliary ballast tank. Pressure hull may be flooded for emergency egress. Scuba regulators and mouthpiece tap main compressed air supply for emergency breathing.

**SURFACE/SHORE SUPPORT:** SOO.

**OWNER:** Technoceans, Inc., New York City.

**BUILDER:** General Dynamics, Electric Boat Div., Groton, Conn.

**REMARKS:** Inactive.

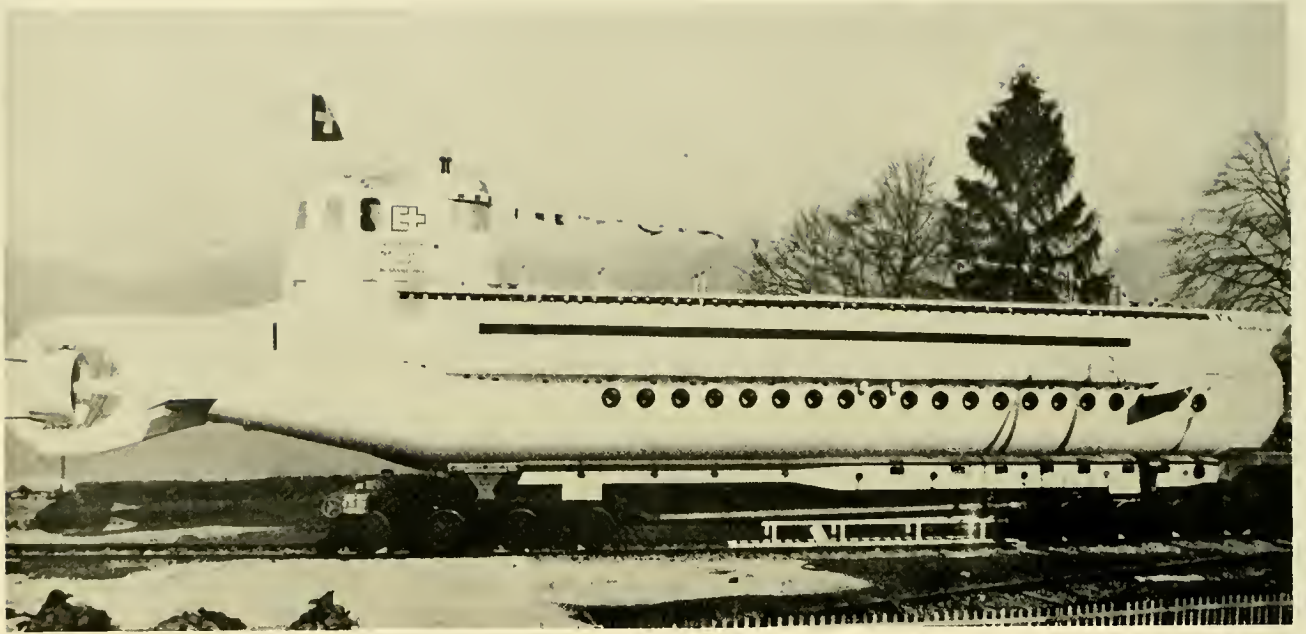

## AUGUSTE PICCARD

LENGTH: ..... 93.5 ft  
BEAM: ..... 19.7 ft  
HEIGHT: ..... 24 ft  
DRAFT: ..... 11.9 ft  
WEIGHT (DRY): ..... 185.2 tons  
OPERATING DEPTH: ..... 2,500 ft  
COLLAPSE DEPTH: ..... 4,500 ft  
LAUNCH DATE: ..... 1963

HATCH DIAMETER: ..... 30.1 in.  
LIFE SUPPORT (MAX): ..... 2,112 man-hr  
TOTAL POWER: ..... 625 kWh  
SPEED (KNOTS): CRUISE ..... 6/10 hr  
MAX ..... 6.3/7 hr  
CREW: PILOTS ..... 4  
OBSERVERS ..... 40  
PAYLOAD: ..... 10 tons

**PRESSURE HULL:** Cylindrical shape of "VOEST" steel quality Aldur 55/68 for cylinder and Aldur 55 for the two hemispherical endcaps. Cylinder is 1.5 in. thick, 10.25-ft OD and 59.7 ft long. Endcaps are the same dimensions and equal to radius of the cylinder. Two hatch openings fore and aft.

**BALLAST/BUOYANCY:** External to the hull in two rows port and starboard are 12 steel ballast tanks of total volume 842 ft<sup>3</sup> which supply 12.5% (23.8 tons) positive buoyancy. Three compensating tanks are provided: two (9 ft<sup>3</sup> ea.) are in the hull near the center of gravity and one (49 ft<sup>3</sup>) is external to the hull, within the keel. On each side of the hull are four bins which hold 5.75 tons of iron shot electromagnetically released.

**PROPULSION/CONTROL:** An electric motor of 75 hp (1,500 rpm) drives a stern-mounted propeller. A directional Kort nozzle acts as the vehicles rudder. Fore- and aft-mounted diving planes provide underway vertical control and stability.

**TRIM:** Two tanks forward and aft of 141 ft<sup>3</sup> total capacity are used to trim the vehicle by transferring water fore or aft with an electric pump.

**POWER SOURCE:** Five lead-acid batteries within and on the bottom of the pressure hull are distributed as follows: two 110-V capacity, 2,000-amp-hr for propulsion; one 220-V, 700-amp-hr for lighting and pumps, one 12-V, 950-amp-hr for control instruments and emergency lighting, and one 6-V, 700-amp-hr for safety ballast control.

**LIFE SUPPORT:** Normal dive of a few hours allows for breathing of ambient air inside vehicle at time of dive. For prolonged dives O<sub>2</sub> is bled into the hull and CO<sub>2</sub> is removed by soda lime which assures a maximum of 2,112 man-hr.

**VIEWING:** Twenty viewports each on port and starboard side, and three in forward hemisphere. All viewports provide 90° of viewing and are 3 in. thick, 12-in. OD and 6-in. ID.

**OPERATING/SCIENTIFIC EQUIPMENT:** TV on sail, compass, pressure depth gages/recorder, down-looking echo sounder.

**MANIPULATORS:** None.

**SAFETY FEATURES:** Iron shot "fail-safe" droppable.

**SURFACE/ShORE SUPPORT:** Size and weight permit only towing to dive site or self-powered transit.

**OWNER:** Horton Maritime Explorations Ltd., North Vancouver, B.C.

**BUILDER:** Giovanola Freres, Monthey, Switzerland.

**REMARKS:** Undergoing refurbishment to conduct gravity and seismic surveys. Originally designated as PX-B.

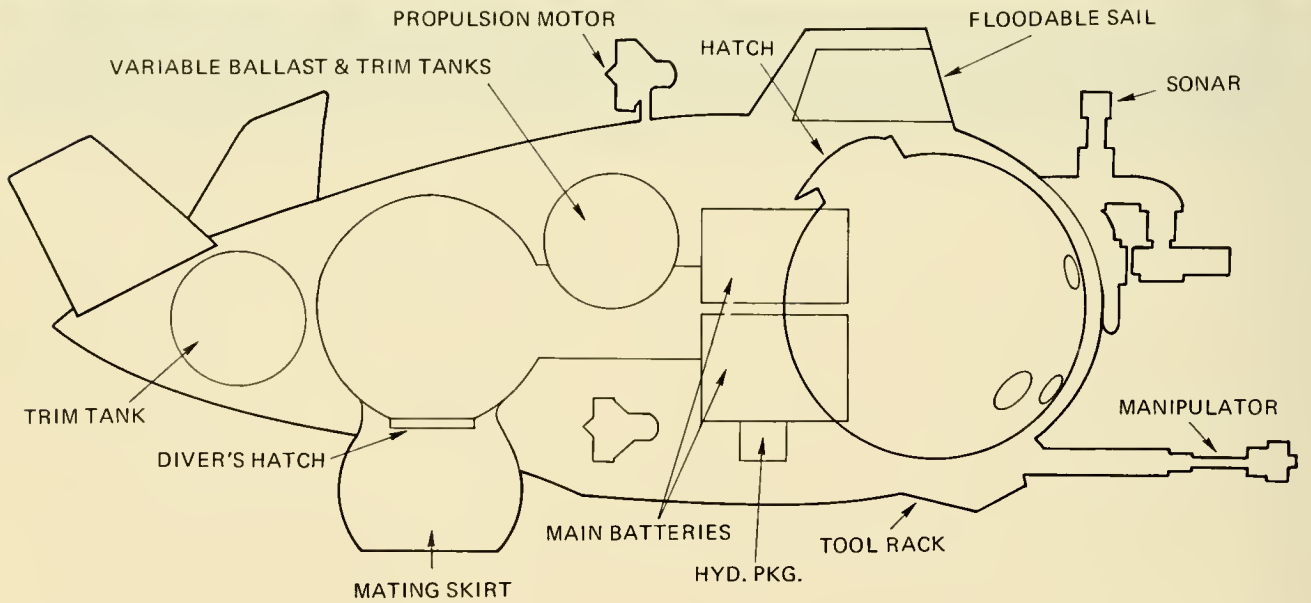

## BEAVER (ROUGHNECK)

LENGTH: .....	26.3 ft	HATCH DIAMETER: .....	25 in.
BEAM: .....	11.5 ft	LIFE SUPPORT (MAX): .....	360 man-hr
HEIGHT: .....	10.3 ft	TOTAL POWER: .....	44 kWh
DRAFT: .....	6.6 ft	SPEED (KNDTS): CRUISE .....	2.5/8 hr
WEIGHT (DRY): .....	17 tons	MAX .....	5/0.3 hr
OPERATING DEPTH: .....	2,000 ft	CREW: PILOTS .....	2
COLLAPSE DEPTH: .....	4,000 ft	OBSERVERS .....	2
LAUNCH DATE: .....	1968	PAYLOAD: .....	2,000 lb

**PRESSURE HULL:** Two spheres joined by a cylindrical tunnel. All hull components are of HY-100 steel. The forward hull is 7-ft OD and 0.481 in. thick with an overhead access hatch. The aft hull is 5.5-ft OD; 0.387 in. thick and has a diver lock-out hatch on the bottom. The connecting tunnel is 25-in. ID; 71 in. long and 0.75 in. thick.

**BALLAST/BUOYANCY:** Main ballast is obtained from two 24-ft<sup>3</sup>-capacity (each) tanks mounted port and starboard. A variable ballast system (combined with the trim system) is capable of obtaining neutral buoyancy within  $\pm 1.5$  ft by admitting or blowing seawater from two, port/starboard spherical tanks. A hydraulically-driven stern winch carries 500 ft of cable to which an anchor may be attached (2,000-lb capacity).

**PROPULSION/CONTROL:** Three 18-in. diam. propellers provide all propulsion. One thruster is mounted topside and the other two port and starboard just below the centerline; all are driven by a 5-hp motor. The inverted "Y" configuration of the propellers and their control (360° rotatable; reversible) allows six degrees of freedom maneuvering and hovering.

**TRIM:** Between three spherical tanks, one aft (1,238 lb) and two amidships (943 lb each), 1,474 lb of water can be transferred in various combinations to produce  $\pm 30^\circ$  pitch and  $\pm 12^\circ$  roll.

**POWER SOURCE:** Main power source is from pressure-compensated, lead-acid batteries which provide 30 kWh at 64 VDC to propulsion motors and hydraulic motors. Auxiliary power is from pressure-compensated, lead-acid batteries which provide 14 kWh at 28 VDC to lights, vehicle controls, electronics. Emergency batteries in the forward sphere are sealed, non-gassing, lead-acid and provide 24 V at 8 amp-hr to jettison squids.

**LIFE SUPPORT:** Both forward and aft pressure hulls have a life support capacity of 48 hr each. A self-contained automatic O<sub>2</sub> supply is carried within the hull and Baralyme and Purafil scrubbers remove CO<sub>2</sub>. The aft sphere can be pressurized to a maximum depth of 1,000 ft, but cannot be depressurized less than ambient pressure.

**VIEWING:** There are 11 acrylic plastic viewports, 1 in each of the 2 hatches and 9 in the forward pressure sphere. These nine ports are equipped with blowers to prevent fogging. These ports have a 5.19-in. ID, an 8.75-in. OD, are 1.78 in. thick, and have a 70° field of view underwater. Of the nine main viewports, five look ahead, down, and to the sides. These are the ports most commonly used during oceanographic missions. The remaining four ports look upward and are used primarily during work or inspection missions. The small port in the hatch of the forward sphere has a 2.19-in. ID, a 3.65-in. OD, and a thickness of 0.73 in. The smallest port, located in the hatch of the after sphere, has a 1.115-in. ID, a 1.875-in. OD, and is 0.38 in. thick.

**OPERATING/SCIENTIFIC EQUIPMENT:** UQC(8.087-kHz) Pan- & tilt-mounted TV camera (W/90° pan), interior still camera synchronized w/exterior strobe, sonar, gyrocompass, speedometer, depth gage, current meter (speed & direction) w/optional strip chart recorder, upward/downward-looking sonar w/strip chart recorder, depth indicator w/visual or strip chart recorder readout, azimuth-scanning sonar w/CRT readout, exterior-mounted 70-mm still camera, two 200-W-sec strobes, interior-mounted 16-mm cine camera w/400-ft capacity, 35-mm and 2¼-in.<sup>2</sup> still cameras, water sampler (sample is drawn directly into aft sphere).

**MANIPULATORS:** Each of the two manipulators has a 9-ft reach, eight degrees of freedom, and a 50-lb lifting capacity. The two manipulators can be equipped with nine different tools to perform various tasks. These tools are: impact wrench, hook hand, parallel jaws, cable cutter, stud gun, centrifugal pump, grapple, drill chuck, and tapping chuck. Rates of motion are variable.

**SAFETY FEATURES:** Non-combustible or slow-burning material within pressure hull, external fittings for gas replenishment. The following is jettisonable by emergency electrical power: Propellers (40 lb each); manipulators (150 lb each); pan/tilt lights, camera and current sensor (155 lb total), anchor (100 lb) and main battery (2,532 lb). Emergency battery, breathing systems and seawater actuated flashlights, pinger, marker buoy with dye and recovery attachment, flares. Personnel may lock-out.

**SURFACE SUPPORT:** SOD.

**OWNER:** International Underwater Contractors, New York.

**BUILDER:** North American Rockwell Corp., Seal Beach, California.

**REMARKS:** Operational. The above description is as the vehicle was originally built.

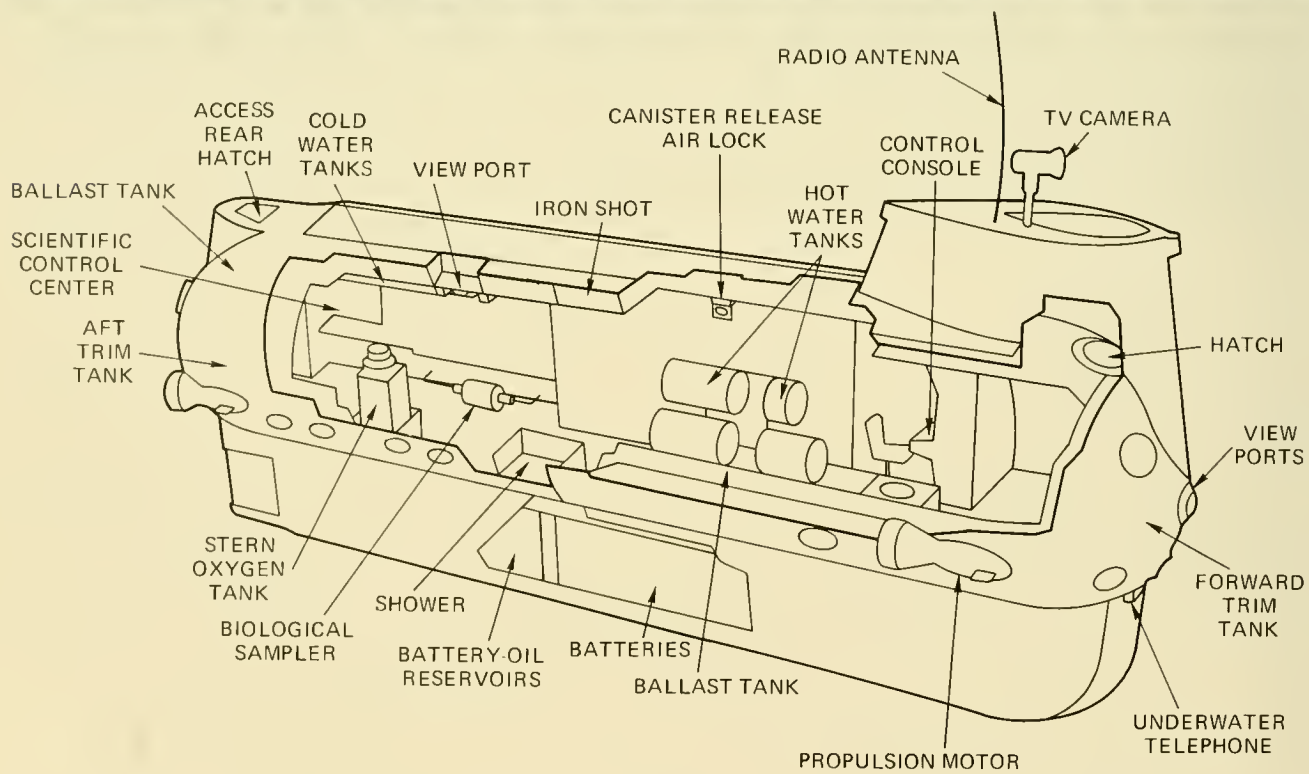
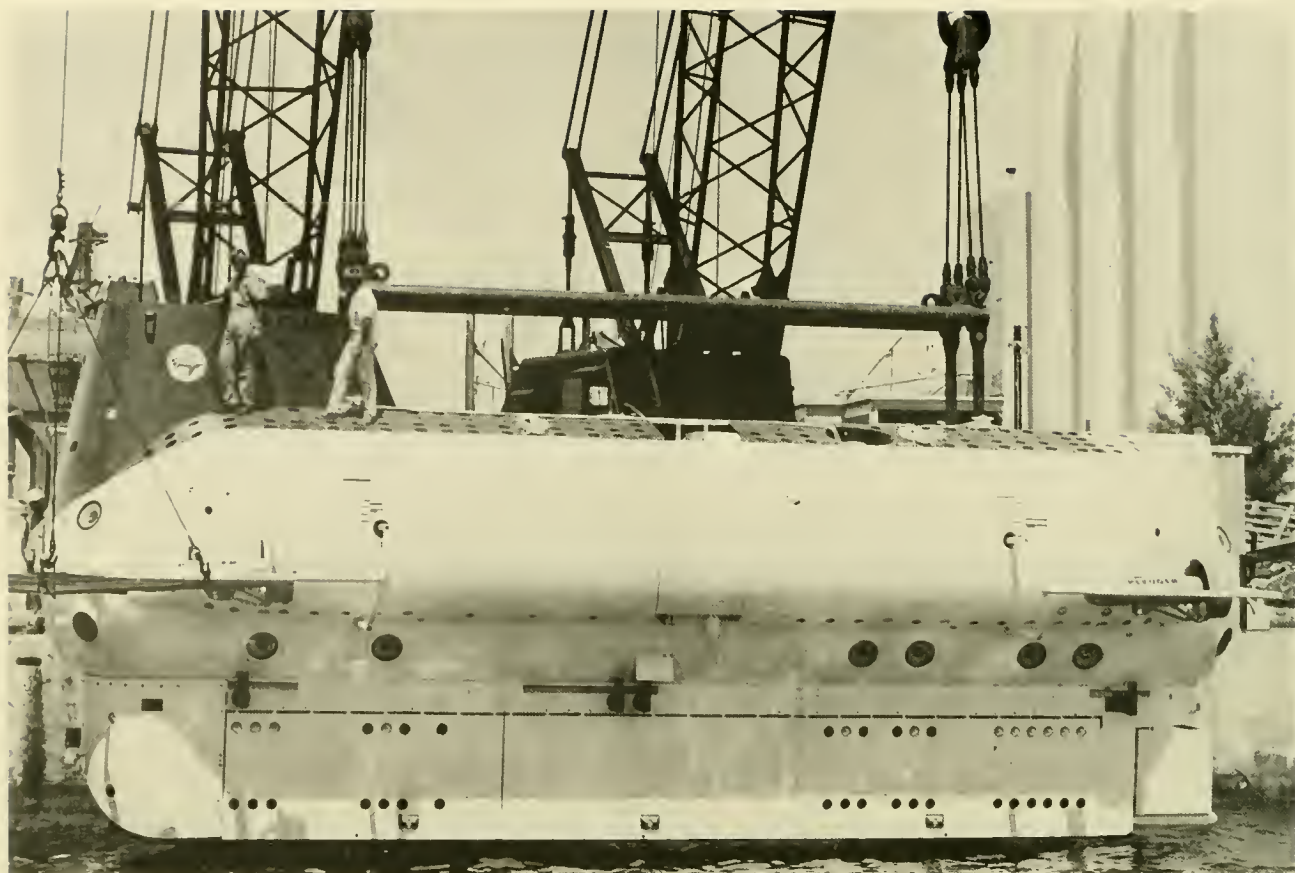



## BEN FRANKLIN

LENGTH: .....	48 ft	HATCH DIAMETER: .....	30 in.
BEAM: .....	20 ft	LIFE SUPPORT (MAX): .....	252 man-days
HEIGHT: .....	21 ft	TOTAL POWER: .....	.750 kWh
WEIGHT (DRY): .....	14.3 tons	SPEED (KNOTS): CRUISE .....	2.5
OPERATING DEPTH: .....	2,000 ft	MAX .....	4
COLLAPSE DEPTH: .....	4,000 ft	CREW: PILOTS .....	2
LAUNCH DATE: .....	1968	OBSERVERS .....	4
		PAYLOAD: .....	5 tons

**PRESSURE HULL:** Cylindrical shape with hemispherical endcaps: OD 10.33 ft, length 48 ft. Hull material is 1-<sup>3</sup>/<sub>8</sub>-in. thick Aldur steel; hemi-heads of Welmonil steel of same thickness. Box ring frames 6.3 in. and 5.7 in. deep are spaced 27.5 in. apart to act as internal stiffeners. Twenty-nine viewports penetrate the hull (two of these are in the hatches). A 5.5-in.-diam. lock-out chamber (SAS) penetrates the hull topside amidships. The hull consists of two asymmetric sections bolted together.

**BALLAST/BUOYANCY:** Main ballast is provided by four fiberglass tanks, two on each side of the hull, of approximately 650-ft<sup>3</sup> capacity (48,600 lb). Variable ballast for depth control is provided by two pressure-resistant steel tanks in the lower keel section which hold 110 ft<sup>3</sup> of water each (6,800 lb). Emergency ballast is 6 tons of iron shot stored in bins between the main ballast tanks. This shot is electromagnetically held and can be dumped as desired. Additionally, a door on the bottom of each bin can be manually opened, totally independent of the electric power.

**PROPULSION/CONTROL:** Propulsion is derived from four-25-hp pressure-compensated, fresh water-filled, 22-V, 3-phase, 50-Hz units manufactured by Pleuger. The four motors can be rotated 360° in the vertical and can be fully reversed. Two rudders are located aft and are electrically controlled and can rotate 30° to each side. By applying reverse thrust on the port motors and forward thrust on the starboard motors or vice versa the vehicle can turn in its own length.

**TRIM:** Trim is controlled by transferring water between two tanks located at each extreme end of the hull. The tanks are made of steel and hold 50 ft<sup>3</sup> of water each (3,100 lb). The tanks are connected by an overhead vent line in the hull and by transfer pipes beneath the deck. The pilot controls two electric pumps which transfer the water at a rate of 1,000 lb/min. The system can obtain a bow angle of ±10°.

**POWER SOURCE:** Power is supplied by 378 lead-acid batteries divided into 4 banks: six-56-V strings & four-28-V strings. An emergency system in the hull consists of fourteen-2-V cells of 192-amp-hr capacity. Two static inverters of 336 VDC power the four main motors; two inverters convert 168 VDC to 115-VAC for the pod positioning motors. The main inverters are 3-phase and can be varied from 50 Hz at 70 VAC to 50 Hz at 220 VAC.

**LIFE SUPPORT:** A total of 922 lb of liquid O<sub>2</sub> is carried. LiOH panels containing activated charcoal are used to remove CO<sub>2</sub> by natural convection currents in the hull. An active odor removal unit consisting of a chemical absorbing section and a catalytic burning section is used to neutralize contaminants not removed by the charcoal. Contaminant levels are determined by Drager gas detector tubes. A manually-operated head macerates metabolic waste products and chemically treats and stores them onboard in six tanks of 6,000-lb capacity. A total 4,600 lb of potable water is carried, 1,600 lb are carried in super insulated tanks at 210°F and are used to reconstitute freeze-dried food.

**VIEWING:** Twenty-nine viewports are located throughout the vehicle, they are 6-in. ID, 12-in. OD and 3 in. thick and provide a 90° field of vision. A smaller viewport is located topside within a hatch of the SAS.

**OPERATING/SCIENTIFIC EQUIPMENT:** UQC (8-10 kHz) magnetic compass, directional gyro, turn/bank indicator, water temperature sensors, depth sensor-recorder gage, CTFM sonar, down/forward Fathometer, tracking pinger, two TV's.

**MANIPULATORS:** None.

**SAFETY FEATURES:** Droppable ballast of 5 tons. Blowing main and variable ballast provides 41,000 lb of lift. Emergency breathing system of 4-hr duration each is obtained through a set of six Drager mixed gas (He/O<sub>2</sub>) diving apparatus. Flooding of the hull and escape through an aft trunk is possible. Fire extinguishers, flashlights, life raft, releasable buoy, xenon light.

**SURFACE/SUPPORT:** Towed or self-powered.

**OWNER:** Horton Maritime Exploration Ltd., Vancouver, B.C.

**BUILDER:** Grumman Aerospace Corp., Bethpage, New York.

**REMARKS:** Not operating. Originally designed as PX-15.



## BENTHOS V

LENGTH: ..... 11.3 ft  
BEAM: ..... 8 ft  
HEIGHT: ..... 6 ft  
DRAFT: ..... 4.5 ft  
WEIGHT (DRY): ..... 2.1 tons  
OPERATING DEPTH: ..... 600 ft  
COLLAPSE DEPTH: ..... 1,200 ft  
LAUNCH DATE: ..... 1963

HATCH DIAMETER: ..... 19 in.  
LIFE SUPPORT (MAX): ..... 96 man-hr  
TOTAL POWER: ..... NA  
SPEED (KNOTS): CRUISE ..... 1/16 hr  
MAX ..... 3/4 hr  
CREW: PILOTS ..... 1  
OBSERVERS ..... 1  
PAYLOAD: ..... 400 lb

**PRESSURE HULL:** Spherical shape of A-285-C steel 60-in. ID and 0.625 in. thick.

**BALLAST/BUOYANCY:** Two separate 2,250 psi air systems. Within the hull are two variable ballast tanks to attain fine buoyancy control. An auxiliary ballast tank is mounted aft and a bow buoyancy tank is forward. Droppable lead ballast.

**PROPULSION/CONTROL:** All maneuvering is provided by two 1-hp, 24-VDC, motors mounted port and starboard amidships that rotate 180° in the vertical.

**TRIM:** The forward and aft buoyancy tanks may be differentially filled to attain up/down bow angles.

**POWER SOURCE:** Three nickel-cadmium batteries supply 80 amp-hr each and are carried within the pressure hull.

**LIFE SUPPORT:** NA.

**VIEWING:** Six viewports. Four look forward above centerline about the horizontal axis and two look down and forward. All are 6-in. diam. and 2 in. thick.

**OPERATING/SCIENTIFIC EQUIPMENT:** Compass, Fathometer, directional gyro.

**MANIPULATORS:** None.

**SAFETY FEATURES** Droppable lead ballast. All ballast tanks can be blown at operating depth with emergency system.

**SURFACE/SUPPORT:** SOO.

**OWNER:** Garrison 8 Divers Corp., Seattle, Washington.

**BUILDER:** Lear Siegler, Inc., Deep River, Conn.

**REMARKS:** Not operating.

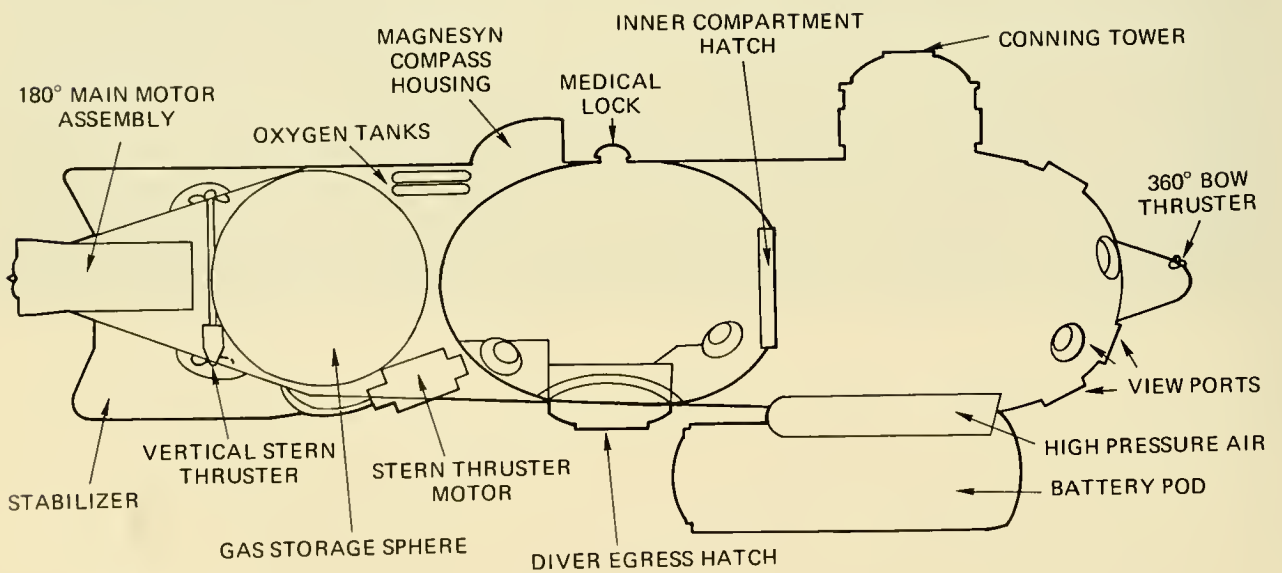
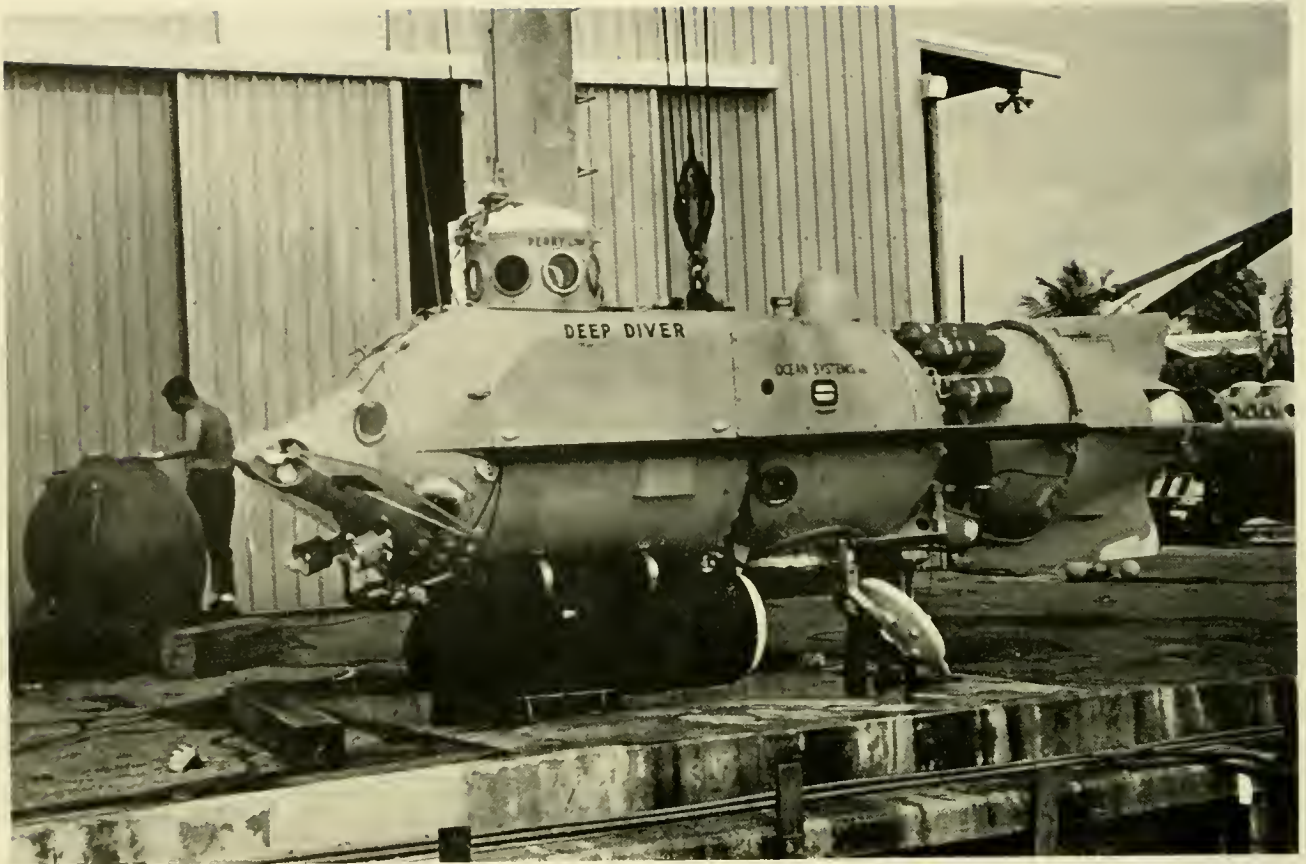

## DEEP DIVER

LENGTH: ..... 22 ft  
BEAM: ..... 5 ft  
HEIGHT: ..... 8.5 ft  
DRAFT: ..... 6.5 ft  
WEIGHT (DRY): ..... 8.25 tons  
OPERATING DEPTH: ..... 1,350 ft; lock-out 1,250 ft  
COLLAPSE DEPTH: ..... 2,000 ft  
LAUNCH DATE: ..... 1968

HATCH DIAMETER: ..... 23 in.  
LIFE SUPPORT (MAX): ..... 32 man-hr  
TOTAL POWER: ..... 23 kWh  
SPEED (KNOTS): CRUISE ..... 2/4 hr  
MAX ..... 3/0.5 hr  
CREW: PILOTS ..... 1  
OBSERVERS ..... 3  
PAYLOAD: ..... 1,500 lb

**PRESSURE HULL:** Forward hull, forward endcap, and diver's compartment are made of 0.5-in. rolled and welded T-1 steel. Forward compartment and diver's cell are 54 in. thick. The transition shelf, connecting pilots and diver's compartment is 5/8 in. SA 212 grade B steel, 55-in. OD, which is welded directly to the diver's compartment. Conning tower is 28-in. OD made of 3/8 in. thick T-1 steel which increases to 0.5 in. at hull intersection. Conning tower is 19 in. above top of hull. All hatches are of cast almag 35 and are impregnated.

**BALLAST/BUOYANCY:** Main ballast tanks of 24.2-ft<sup>3</sup> (845 lb) capacity are located port and starboard of the forward hull adjacent to the conning tower and are made of 11-gage mild steel. The trim tanks may also serve as buoyancy control and hold 676 lb of seawater. The battery pod adds an additional 1,500 lb of negative buoyancy which can be dropped in an emergency. The ballast tank vent valves are operated by a reach rod that penetrates the pressure hull.

**PROPULSION/CONTROL:** Main propulsion is a G.E. 10-hp, 1,150-rpm, 240-V, 48-amp motor contained in a pressure-compensated housing and is pivoted to swing 90° each side of dead center. A stern thruster, consisting of two right-handed propellers turning on a single 1-in. stainless steel shaft and driven by a 3-hp, 1,140-rpm, 120-V, 29-amp, DC, G.E. motor is mounted in a pressure-compensated container. This bow thruster is driven by a G.E., 3-hp, 1,750-3,350-rpm, 120-V, 24-amp, DC motor which is shared with the trim tank pump and is mounted internally. The bow propulsion unit may be rotated through 360° in the vertical plane and serves as both horizontal and vertical thruster.

**TRIM:** Two tanks provide trim: One in the pilot's compartment (365 lb) and one in the diver's compartment (375 lb). The pilot's tank is split into six sections and is pumped dry. The diver's trim tank is split into two sections and may be blown or pumped dry. The diver's tank provides negative buoyancy to partially compensate for the loss of weight when the divers leave the vehicle.

**POWER SOURCE:** The main power supply consists of four separate battery banks of thirty 12-V, lead-acid batteries, 92-amp-hr capacity each, at 20-hr rate which are contained at atmospheric pressure in a droppable pod suspended under the pilot's compartment. The total water weight of the 0.5-in.-thick steel (SA 212 grade B) pod is 1,500 lb.

**LIFE SUPPORT:** O<sub>2</sub> is supplied from five bottles at 2,200 psi of 338-ft<sup>3</sup> total capacity. Two bottles regularly supply the pilot's compartment and three supply the diver's compartment, but provisions are made for any arrangement desired. The bottles are stored externally between the He sphere and diver's compartment. CO<sub>2</sub> is removed by two scrubbers of Baralyme, 6-lb capacity each, in the pilot's compartment and one 12-lb capacity scrubber in the diver's compartment. Two blowers, of 24 cfm, force air through the scrubbers; three 12-VDC fans help circulate air throughout. A pre-mixed He-O<sub>2</sub> supply can be stored in the 0.5-in.-thick, T-1 steel, 49-in. OD sphere. Two hookah hose adapters for divers working outside are also carried.

**VIEWING** Twenty-one acrylic plastic viewports, 12 are double-acting and are 6-in. ID, 8-in. OD and of 2-in. (external) and 1.75-in. (internal) thickness. The nine single-acting viewports are 6-in. ID, 8-in. OD and 0.5 in. thick.

**MANIPULATORS:** None.

**SAFETY FEATURES** Main ballast and trim tanks can supply 845 lb and 676 lb of positive buoyancy when blown; a jettisoning battery pod provides 1,500 lb of buoyancy. Emergency breathing can be through scuba regulators from the main air system or by breathing pre-mixed gas through hookah rigs. By pressurizing the boat, escape is possible through the diver's compartment. Flooding the boat allows escape through the conning tower. Seawater-activated pinger, gas and electric power connections for supply from surface. Flares, life vests, anchor, dry chemical fire extinguisher, external flashing light.

**SURFACE SUPPORT:** Submersible is air, ship or truck transportable. It can be towed by or carried on a ship during operations. A crew of five is required for support of the submersible. The support ship must be a minimum of 100 ft LOA.

**OWNER:** Marine Sciences Ctr., Ft. Pierce, Fla.

**BUILDER:** Perry Submarine Builders, Riviera Beach, Fla.

**REMARKS:** Decommissioned, Donated to Smithsonian Inst. On display at Link Park, Ft. Pierce, Fla. Originally designated PLC-4.

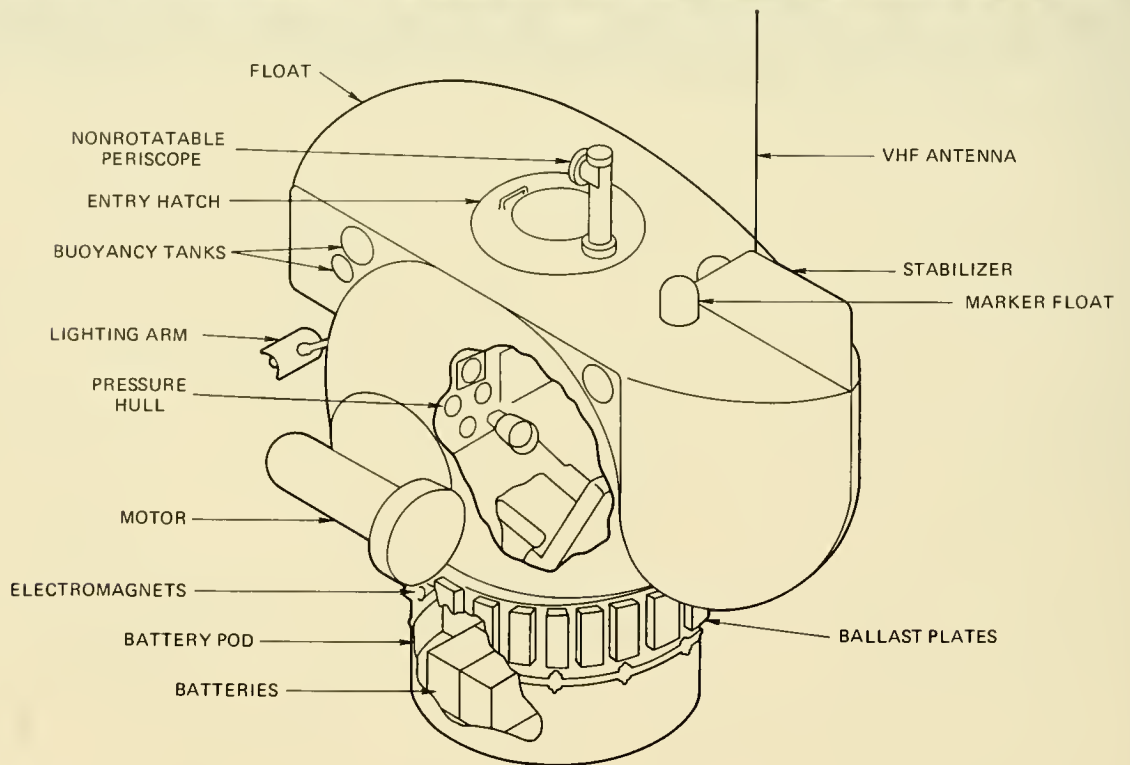
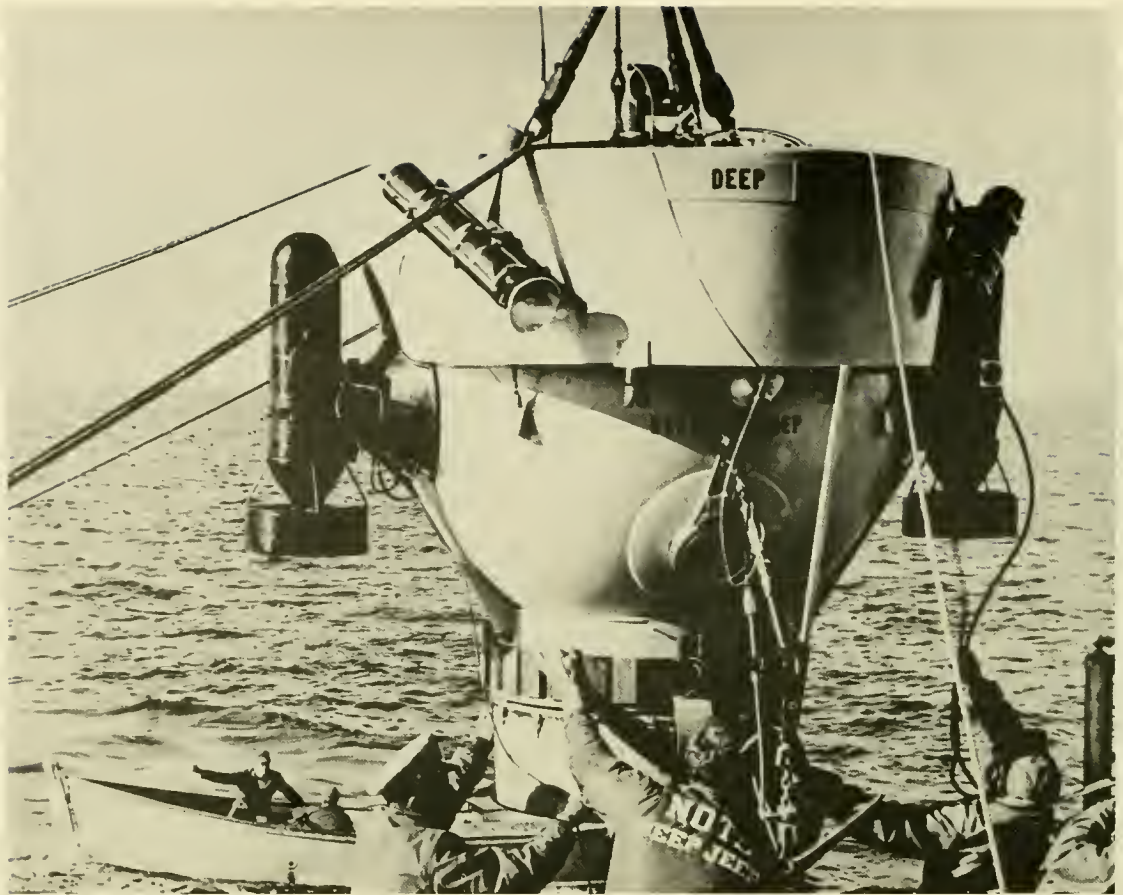

## DEEP JEEP

LENGTH: .....10 ft  
BEAM: .....8.5 ft  
HEIGHT: .....8 ft  
DRAFT: .....7.75 ft  
WEIGHT (DRY): .....4 tons  
OPERATING DEPTH: .....2,000 ft  
COLLAPSE DEPTH: .....5,250 ft  
LAUNCH DATE: .....1964

HATCH DIAMETER: .....24 in.  
LIFE SUPPORT (MAX): .....104 man-hr  
TOTAL POWER: .....7 kWh  
SPEED (KNOTS): CRUISE .....1/5 hr  
MAX .....2/2 hr  
CREW: PILOTS .....1  
OBSERVERS .....1  
PAYLOAD: .....200 lb

**PRESSURE HULL:** Spherical shape of A-225-B steel 0.85 in. thick and 5-ft ID.

**BALLAST/BUOYANCY:** Positive buoyancy provided by the pressure hull and an epoxy resin float embedded with glass microballoons (20-100-micron diam.) producing an overall density of 37 lb/ft<sup>3</sup>. Negative buoyancy is obtained by thirty-4-lb steel plates surrounding the battery pod which may be electromagnetically released individually. Two toroidal tanks (free flooding) provide an additional 500 lb of negative buoyancy.

**PROPULSION/CONTROL:** Propulsion is obtained by two port/starboard 0.75-hp electric motors which drive a 12-in.-diam. propeller. The motors can pivot simultaneously through 180° of arc, are reversible and have variable speed. A vertical fin atop the aft end of the float acts as an underway stabilizer.

**TRIM:** No systems required.

**POWER SOURCE:** Eight 6-V, pressure-compensated, lead-acid batteries mounted below the pressure hull supply all power.

**LIFE SUPPORT:** Compressed O<sub>2</sub> is dispensed through a hospital-type flowmeter and circulated by an electric fan. CO<sub>2</sub> is removed by trays of soda lime which also contain a desiccant (silica gel) to reduce humidity. CO<sub>2</sub> and O<sub>2</sub> are periodically measured.

**VIEWING:** One acrylic plastic viewport 5-in. OD and 2 in. thick. Monocular viewing scopes (one/occupant) allow synoptic viewing through 40°.

**OPERATING/SCIENTIFIC EQUIPMENT:** UQC, horizontal and vertical avoidance sonars, depth gage.

**MANIPULATORS:** None.

**SAFETY FEATURES:** Droppable battery pod (560 lb) and steel plates. Pressure hull may be flooded to 600-ft depth for emergency egress. Scuba breathers can provide air for 50 hr. Two floats can be released which carry 3,000 ft of nylon line to the surface for subsequent attachment of a rescue line to a clevis on the hull.

**SURFACE/SHORE SUPPORT:** SOO.

**OWNER:** Scripps Institute of Oceanography, LaJolla, California.

**BUILDER:** U.S. Naval Ordnance Test Station, China Lake, California.

**REMARKS:** Not operating.

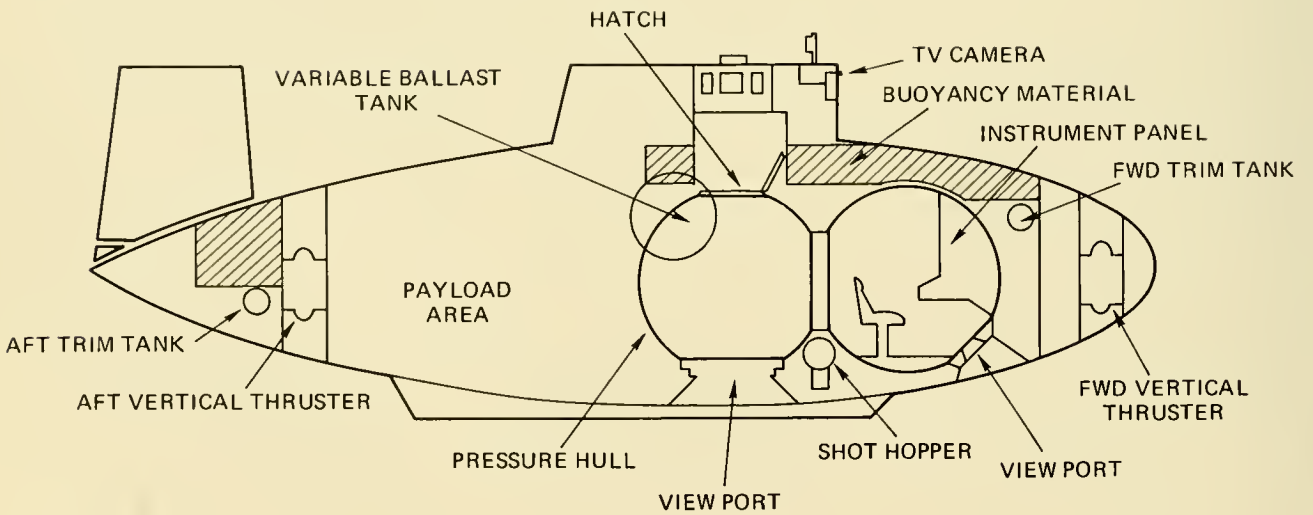
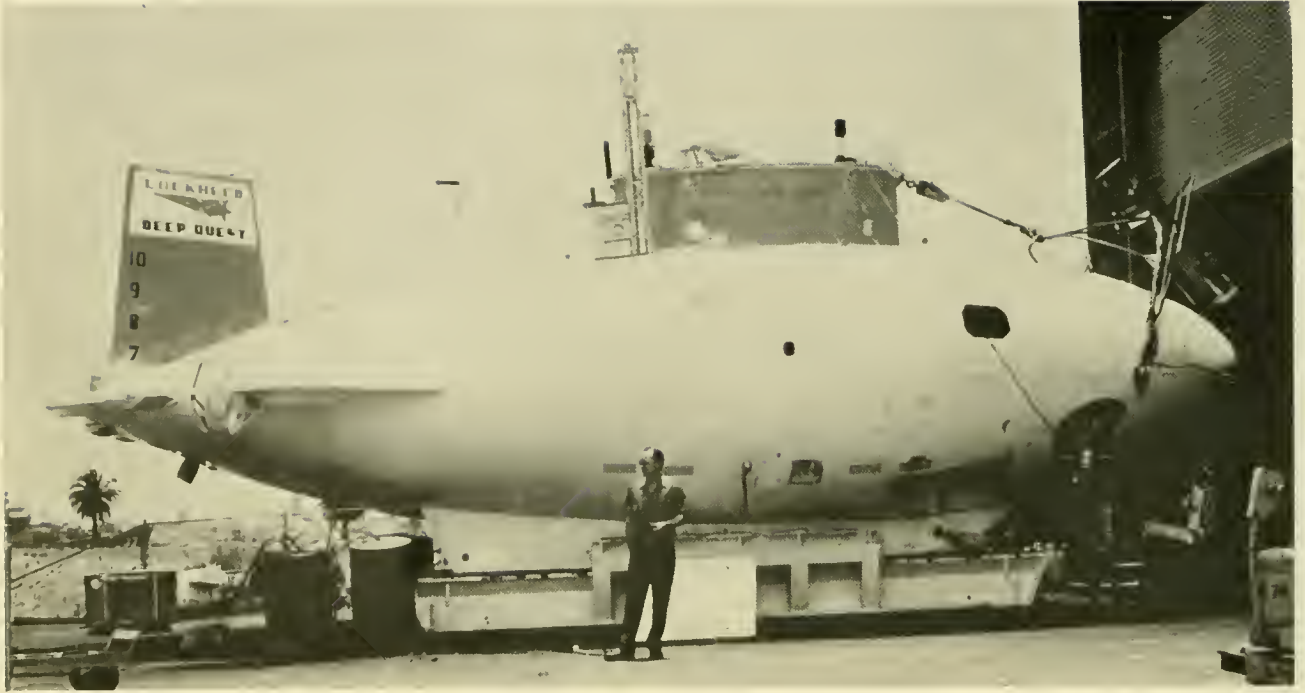



## DEEP QUEST

LENGTH: ..... 39 ft 11 3/4 in.  
BEAM: ..... 19 ft  
HEIGHT: ..... 13.25 ft  
DRAFT: ..... 8.6 ft  
WEIGHT (DRY): ..... 52 tons  
OPERATING DEPTH: ..... 8,000 ft  
COLLAPSE DEPTH: ..... 13,000 ft  
LAUNCH DATE: ..... 1967

HATCH DIAMETER: ..... 20 in.  
LIFE SUPPORT (MAX): ..... 204 man-hr  
TOTAL POWER: ..... 230 kWh  
SPEED (KNOTS): CRUISE ..... 3/18 hr  
MAX ..... 3/12 hr  
CREW: PILOTS ..... 2  
OBSERVERS ..... 2  
PAYLOAD: ..... 7,000 lb

**PRESSURE HULL:** Bi-sphere shape, each sphere is 0.895 in. thick, 7-ft OD and made of 18% nickel, KSI grade, maraging steel. Spheres are welded together and connection between the two is a 20-in.-diam. opening. Forward sphere contains three thru-hull penetrations: two are electrical penetrations and one is the viewport. After sphere contains three reinforced welded inserts for the three access hatches.

**BALLAST/BUOYANCY:** Main ballast consists of four tanks mounted two on each side to provide a reserve buoyancy of 12%. A seawater variable ballast system of two spherical tanks, 37-in.-diam., 200-KSI grade maraging steel, one on each side, provides 1,828 lb of ballast. A steel shot ballast system (three separate tanks) supplies 1,700 lb of ballast. Syntactic foam (36,000 lb at 36 ocf ave. density) provides additional positive buoyancy.

**PROPULSION/CONTROL:** Forward and reverse thrust is from two, reversible, stern-mounted, 7.5-hp, AC, motor driven propellers. Vertical thrust is from two fore- and aft-mounted, 7.5-hp, AC motors and ducted propellers. Lateral thrust is from fore- and aft-mounted water jets powered by two 7.5-hp, AC motors. A rudder and stern planes provide additional underway steering control.

**TRIM:** A 30° up or down bow angle can be produced by transferring 1,440 lb of oil and mercury between two fore- and aft-mounted, 18-in.-diam., spherical, steel tanks. A 10° port or starboard list can be attained by transfer of 828 lb of mercury between two 15-in.-diam. tanks. Both trim and list systems are pressure compensated.

**POWER SOURCE:** Main power is derived from two 115-VDC, pressure-compensated, lead-acid batteries mounted below and between the bi-spheres. Two 23-VDC, silver-zinc batteries are carried in the pressure hull to provide 3.6 kWh of emergency power. Each main battery consists of four 30-VDC, series-connected batteries composed of 16 Exide RSC lead-acid cells.

**LIFE SUPPORT:** Four 0.37-ft<sup>3</sup>-capacity tanks (2,250 psi) supply O<sub>2</sub> for normal usage. CO<sub>2</sub> is removed by blowing the air through LiOH/charcoal canisters. O<sub>2</sub> level is automatically monitored and regulated. Emergency breathing is by four full-face masks connected to an oxygen-demand system for survival periods of 12 man-hr. Temperature and humidity are automatically regulated.

**VIEWING:** Two acrylic plastic viewports are provided. One is located on the axis of the forward sphere and is a few degrees below the horizontal; it is 3 in. thick, 9-in. OD, 3-in. ID. The second is in the aft sphere and looks directly downward; it is 5 in. thick, 15-in. OD, 5-in. ID. The aft viewport is equipped with an optical remote viewing system of 180° objective in the vertical and 360° in the horizontal.

**OPERATING/SCIENTIFIC EQUIPMENT:** UQC, gyrocompass, CTFM sonar, altitude/depth sonar, vehicle control computer, four TV cameras, 70-mm still camera/with strobe light, sediment corer, sediment vane shear device.

**MANIPULATORS:** Two manipulators mounted forward and capable of seven degrees of freedom.

**SAFETY FEATURES:** Emergency breathing apparatus. Emergency power within the pressure hull. Positive buoyancy can be obtained by jettisoning: shot ballast (1,700 lb), list mercury (800 lb), trim mercury (1,250 lb), main batteries (3,500 lb) and manipulators (170 lb).

**SURFACE SUPPORT:** Supported by a 100-ft (LOA), 40-ft beam, 395-ton, split stern ship using an elevator ramp for launch/retrieval. An operations manager coordinates sub and ship operations at sea. Two pilots and 18 additional personnel onboard ship maintain and support at-sea operations. Vehicle is air and semi-trailer transportable.

**OWNER:** Lockheed Missiles and Space Corp., Sunnyvale, California.

**BUILDER:** Lockheed Missiles and Space Corp., Sunnyvale, California.

**REMARKS:** Operational.

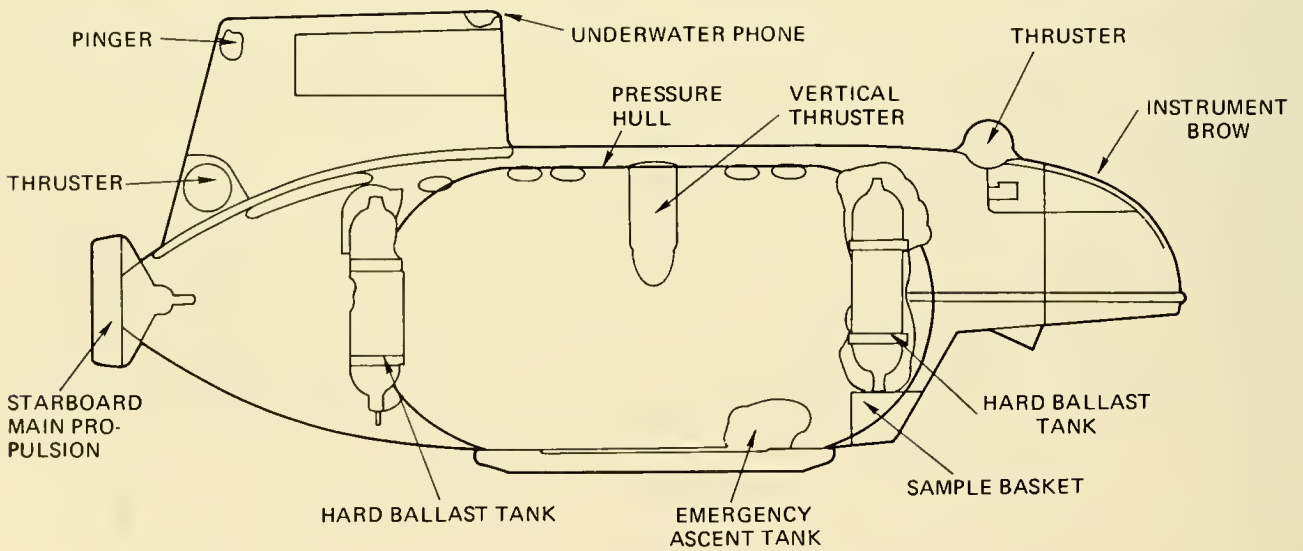

## DEEPSTAR 2000

LENGTH: ..... 20 ft  
BEAM: ..... 7.5 ft  
HEIGHT: ..... 8.5 ft  
DRAFT: ..... 5 ft  
WEIGHT (DRY): ..... 8.75 tons  
OPERATING DEPTH: ..... 2,000 ft  
COLLAPSE DEPTH: ..... 4,130 ft  
LAUNCH DATE: ..... 1969

HATCH DIAMETER: ..... 15.75 in.  
LIFE SUPPORT (MAX): ..... 144 man-hr  
TOTAL POWER: ..... 26.5 kWh  
SPEED (KNOTS): CRUISE ..... 1/8 hr  
                                  MAX ..... 3/4 hr  
CREW: PILOTS ..... 1  
          OBSERVERS ..... 2  
PAYLOAD: ..... 450 lb

**PRESSURE HULL:** Cylindrical shape 5-ft OD with hemispherical endcaps. Hull thickness 0.75 in.; overall hull length 10 ft. Hull material HY-80 steel. Penetrations include three viewports, one hatch, seven mechanical and three electrical.

**BALLAST/BUOYANCY:** Main ballast system for surface buoyancy consists of flooded soft tanks blown dry with high pressure air. Tanks are an integral part of the exostructure and fairing. Variable ballast system consists of four hard tanks and collapsible bladders. Oil is pumped from hard tanks to bladders to increase displacement or reversed to decrease displacement. Permanently installed syntactic foam is used to obtain submerged neutral buoyancy.

**PROPULSION/CONTROL:** Two main propellers in the stern (5-hp ea.), reversible, servo-valve controlled, continuously variable. Two vertical thrusters port and starboard, two horizontal thrusters fore and aft. All thrusters are powered by hydraulic motors driven off of the main hydraulic plant (two plants at 10-hp ea.). Each electric motor is pressure-compensated, 120-VDC, 7.5-hp.

**TRIM:** Hydraulic-activated drive moves batteries fore or aft allowing pitch angles of up to  $\pm 25^\circ$ .

**POWER SOURCE:** Lead-acid batteries; one 120-V, 150-amp-hr, two 28-V, 150-amp-hr, located externally and pressure-compensated. Selectively droppable.

**LIFE SUPPORT:** Gaseous O<sub>2</sub>; two flasks of 840 in.<sup>3</sup> each at 2,250 psi. Monitors for CO<sub>2</sub>, O<sub>2</sub>, cabin pressure, temperature and humidity. Emergency (three 1-hr) breathers. LiOH to remove CO<sub>2</sub>.

**VIEWING:** Two, 4.5-in. ID, of plastic looking 19° downward and slightly to port and starboard giving overlapping fields of view. One, 2-in. ID, looking forward on centerline for still camera.

**OPERATING/SCIENTIFIC EQUIPMENT:** Sperry MK27 & repeater, FM radio, UQC, TV camera, alt/depth sonar, gyrocompass, pressure, depth, rate and acceleration system, extendable light booms with up to 2,500 W of lights, xenon flasher, voice recorder, velocity sensor, temperature probe, ambient light sensor, sound velocity sensor, subbottom profiler, side-looking sonar, still and cine cameras and sediment corers. Data logger for any digital signal, 8-track.

**MANIPULATORS:** One with two degrees of freedom.

**SAFETY FEATURES:** Main ballast can be blown at operating depth (500-lb lift). Mechanically jettisonable high pressure Air Bottles (500 lb). Mechanically jettisonable batteries (1,250 lb). Mechanically jettisonable payload brow (500 lb). Emergency breathing, manipulator jettisonable, life raft, flares, life jackets.

**SURFACE/SUPPORT:** SOO.

**OWNER:** Westinghouse Ocean Research and Engineering Center, Annapolis, Md.

**BUILDER:** Westinghouse Electric Corp.

**REMARKS:** Operationally ready, but has not dived since 1972.

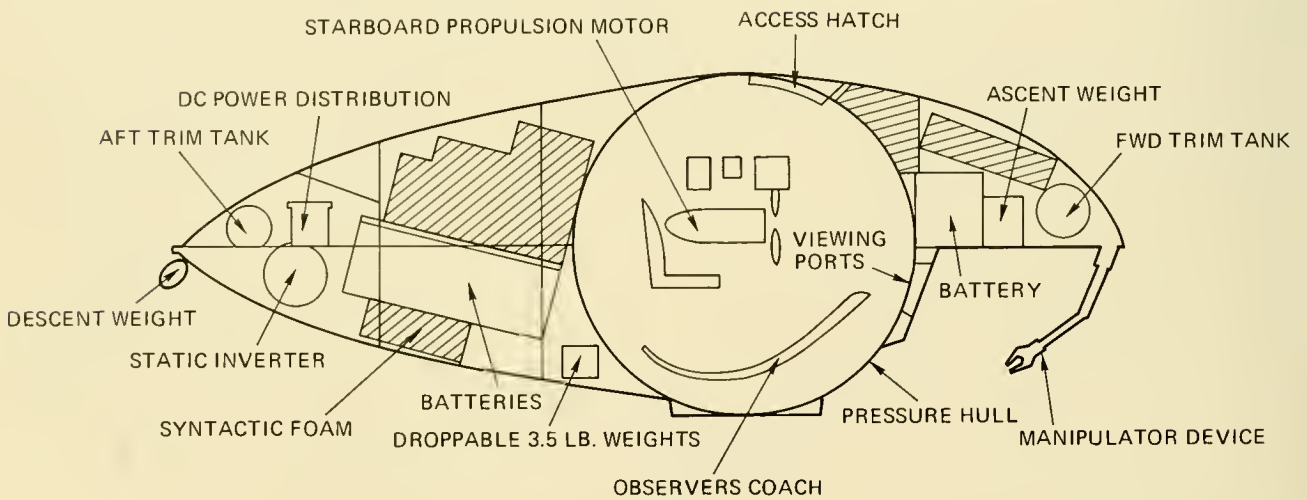
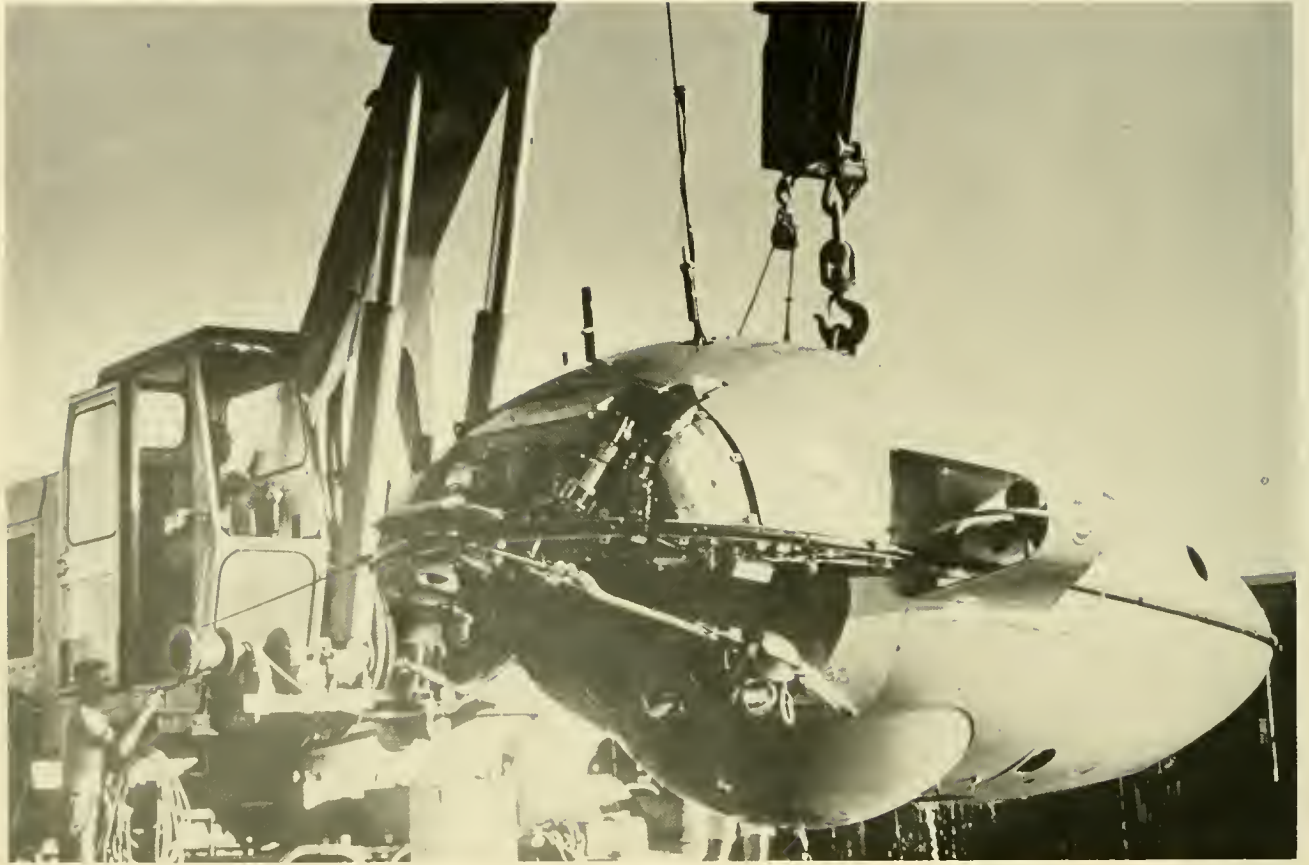

## DEEPSTAR 4000

LENGTH: ..... 18 ft  
BEAM: ..... 11 ft  
HEIGHT: ..... 7 ft  
DRAFT: ..... 7 ft  
WEIGHT (DRY): ..... 9 tons  
OPERATING DEPTH: ..... 4,000 ft  
COLLAPSE DEPTH: ..... 7,600 ft  
LAUNCH DATE: ..... 1965

HATCH DIAMETER: ..... 15.75 in.  
LIFE SUPPORT (MAX): ..... 144 man-hr  
TOTAL POWER: ..... 49.6 kWh  
SPEED (KNOTS): CRUISE ..... 1.5/6 hr  
MAX ..... 3/4 hr  
CREW: PILOTS ..... 1  
OBSERVERS ..... 2  
PAYLOAD: ..... 450 lb

**PRESSURE HULL:** The hull consists of a 78.75-in. OD, HY-80 steel sphere with 11 openings machined into the sphere. These include two viewports, one camera port, one hatch, two electrical penetrations and five mechanical shaft feedthroughs.

**BALLAST/BUOYANCY:** Main ballast tanks are used for positive buoyancy on the surface. Negative buoyancy is decreased by dropping small (3.4-lb) trim weights. DEEPSTAR dives with a 220-lb descent weight which is dropped as the vehicle nears the bottom. At the termination of a dive the 187-lb ascent weight is dropped allowing the vehicle to rise. A variable ballast system provides regulated increments of ballast change by transfer of oil between hard tanks and flexible bladders; 4,500 lb of syntactic foam (this has a density of 39 pcf) are installed to give neutral overall buoyancy.

**PROPULSION/CONTROL:** Two fixed, reversible, 5-hp motors are mounted port and starboard just forward of amidships. The motors are variable in speed from 30 to 900 rpm.

**TRIM:** Two pitch control cylinders mounted on the centerline, one forward and one aft, with hydraulically-activated pistons are used to transfer 225 lb of mercury from one end of the boat to the other allowing pitch angles of up to  $\pm 30^\circ$ .

**POWER SOURCE:** Lead-acid battery, 124-VDC, 400-amp-hr. Three 2-V dry cells are carried for emergency operation of radio, flasher and UQC. The lead-acid battery is carried externally and is pressure compensated.

**LIFE SUPPORT:** CO<sub>2</sub> is absorbed by blowing cabin air through LiOH granules then directing it downward across the viewports. O<sub>2</sub> is supplied through a flow-control valve from a high pressure gaseous O<sub>2</sub> supply. A bypass valve allows manual control of O<sub>2</sub> if flow regulation fails.

**VIEWING:** Two viewports provide overlapping coverage for the pilot and one observer. These ports are 21° below the horizontal centerline and 16° port and starboard of the vertical centerline. Each viewport is 3.9 in. thick with an ID of 4.33 in. and an OD of 11.1 in. The ports are equipped with blowers to prevent fogging. There is also a smaller port located on the vertical centerline which is used exclusively for cine photography. This port is 1.51 in. thick with an ID of 1.69 in. and an OD of 3.32 in.

**OPERATING/SCIENTIFIC EQUIPMENT:** Gyrocompass, three sonar transducers (forward, downward, and upward-looking) with strip chart recorder, depth sensor, depth monitor with interior dial readout, depth indicator, current meter (speed only), odometer, water temperature probe, inclinometer, yaw indicator, 2-channel tape recorder, interior-mounted 16-mm cine camera (400-ft film capacity), exterior-mounted 70-mm still camera with two strobes.

**MANIPULATORS:** One with three degrees of freedom.

**SAFETY FEATURES:** Releasable forward battery (600 lb). Jettisonable manipulator. Mechanically releasable trim mercury (225 lb), backed up by 3,000 psi N<sub>2</sub> for angle jettison. Mechanically releasable ascent weight is 185 lb (also released by an overdepth release). Small weight dropper rack contains 150 lb of weights which may be released hydraulically or mechanically. An overdepth release device, independent of the pilot and power supplies, will release both descent and ascent weights if vehicle reaches 4,200 ft  $\pm 3\%$ .

**SURFACE SUPPORT:** DEEPSTAR has no permanent support ship, but is tended by a leased vessel. The last such ship was the M/V SEARCH TIDE owned by Tidewater Marine, New Orleans, La. SEARCH TIDE is a typical offshore supply boat, designed to service drilling rigs in the Gulf of Mexico. SEARCH TIDE is 155 ft LOA with a beam of 36 ft and a draft of 11 ft. Her displacement is 199 tons. She is powered by two 1,000-hp diesel engines giving a cruising speed of 12 knots and a range of 3,700 miles. Vans mounted on the deck provide living quarters, a machine shop, a darkroom, and a maintenance shop for DEEPSTAR's electronics.

**OWNER:** Westinghouse Ocean Research and Engineering Center, Annapolis, Md.

**BUILDER:** Westinghouse Electric Corp.

**REMARKS:** Not operating.

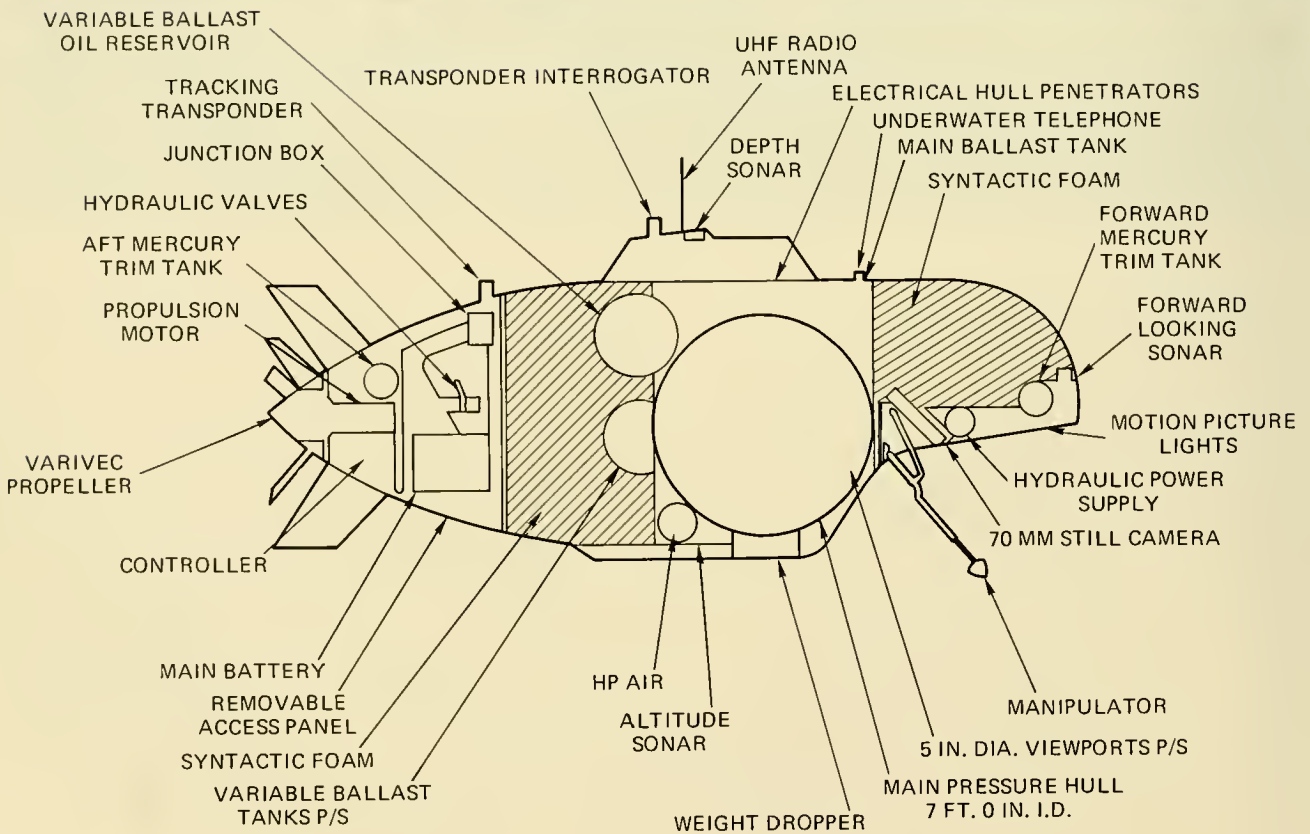
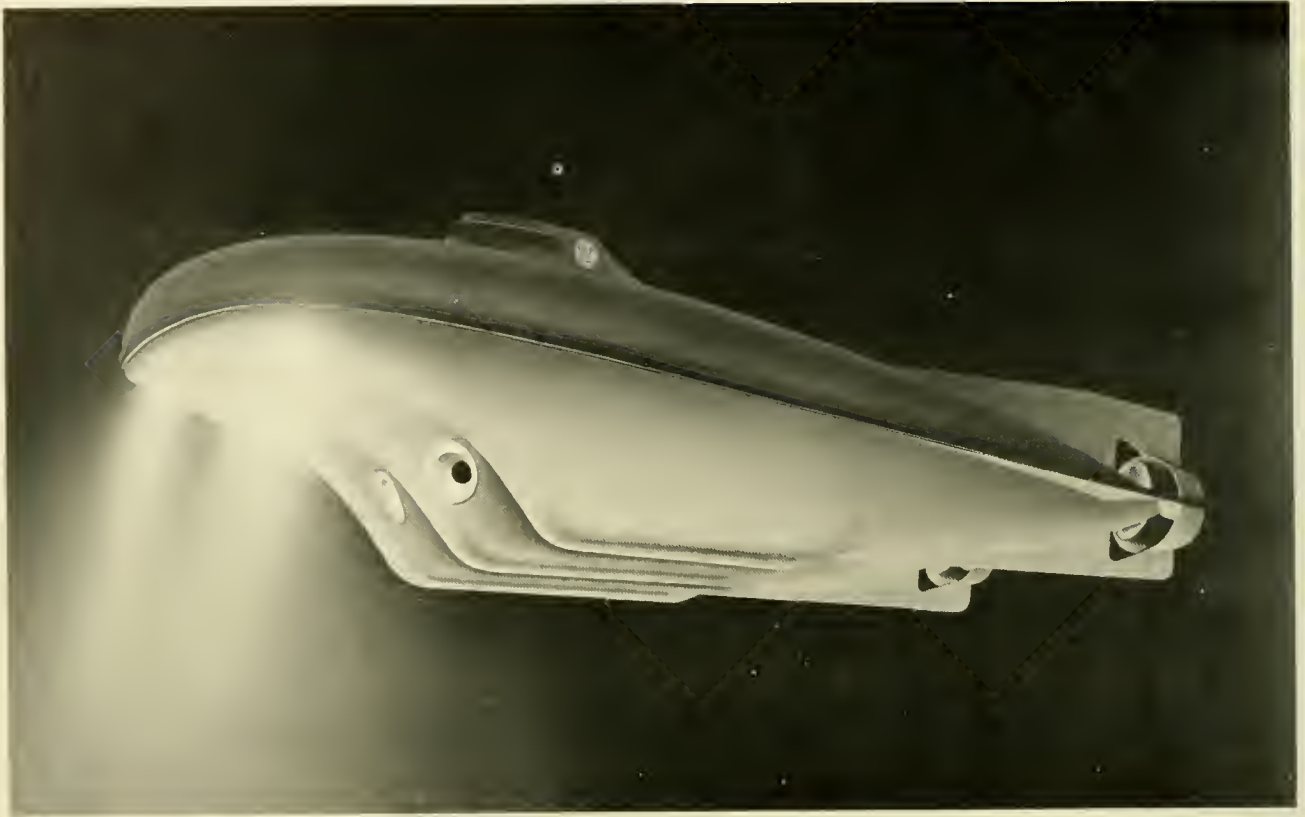

## DEEPSTAR 20000

LENGTH: ..... 36 ft  
BEAM: ..... 10.25 ft  
HEIGHT: ..... NA  
DRAFT: ..... NA  
WEIGHT (DRY): ..... 42.5 tons  
OPERATING DEPTH: ..... 20,000 ft  
COLLAPSE DEPTH: ..... NA  
LAUNCH DATE: ..... (construction halted in 1970)

HATCH DIAMETER: ..... 16 in.  
LIFE SUPPORT (MAX): ..... 144 man hr  
TOTAL POWER: .....  
SPEED (KNOTS): CRUISE ..... 2  
                          MAX ..... 3  
CREW: PILOTS ..... 1  
          OBSERVERS ..... 2  
PAYLOAD: ..... 500-2,000 lb

**PRESSURE HULL:** Spherical shape, 7-ft ID composed of HY-140 steel and weighing 12,414 lb.

**BALLAST/BUOYANCY:** Syntactic foam (42-pcf) permanently installed main ballast system uses 3,000-psi air to blow tanks dry and provide 6,800 lb of surface buoyancy. Descent weight of 300 lb dropped near the bottom provides neutral buoyancy. A bladder/hard tank system reduces displacement proportional to depth to compensate for buoyancy gained by hull rigidity. A 500-lb ascent weight is used to initiate ascent. The bladder/hard tank air system is also used for  $\pm 1,100$ -lb changes utilizing a hydraulic pump.

**PROPULSION/CONTROL:** One 10-hp, AC motor drives a Varivec propeller mounted aft on centerline. One hydraulic pump driven by the same motor provides hydraulic power for vehicle hydraulics underway.

**TRIM:** Mercury tanks fore and aft transfer 630 lb of mercury to obtain pitch angles of  $\pm 30^\circ$ .

**POWER SOURCES:** 120-VDC, silver-zinc batteries are carried externally and are pressure compensated. One 29-VDC auxiliary battery and one 28-VDC emergency battery are carried in the pressure hull.

**LIFE SUPPORT:** Gaseous  $O_2$ . LiOH to remove  $CO_2$ .

**VIEWING:** Two viewports, 4.5-in. ID, with overlapping field of view looking forward and down. One 2.25-in. ID camera port on centerline looking forward and down.

**OPERATING/SCIENTIFIC EQUIPMENT:** Tape recorder, FM radio, velocity indicator, transponder, 70-mm still camera, 16-mm cine camera, water temperature sensor, side-looking sonar, two depth gages.

**MANIPULATORS:** NA.

**SAFETY FEATURES:** Surface lights, radio beacon.

**SURFACE SUPPORT:** NA.

**OWNER:** Westinghouse Ocean Research and Engineering Center, Annapolis, Md.

**BUILDER:** Westinghouse Electric Corp.

**REMARKS:** Major components completed and in storage; never assembled.

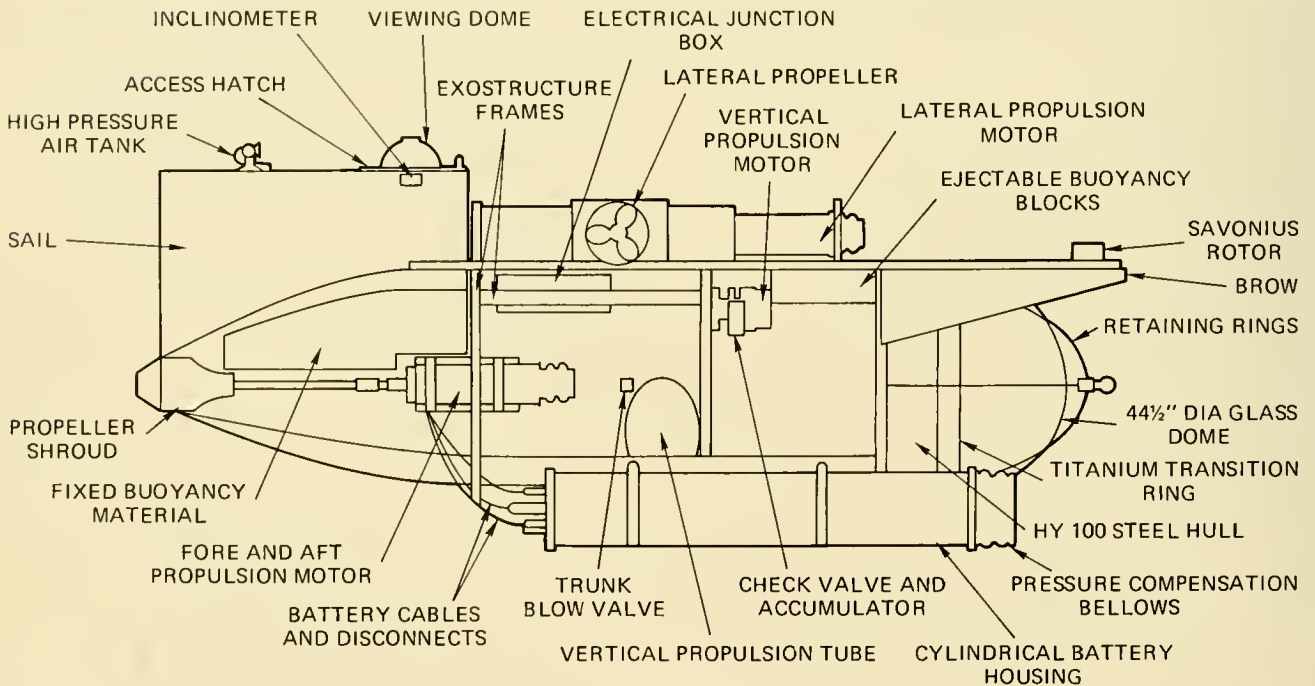
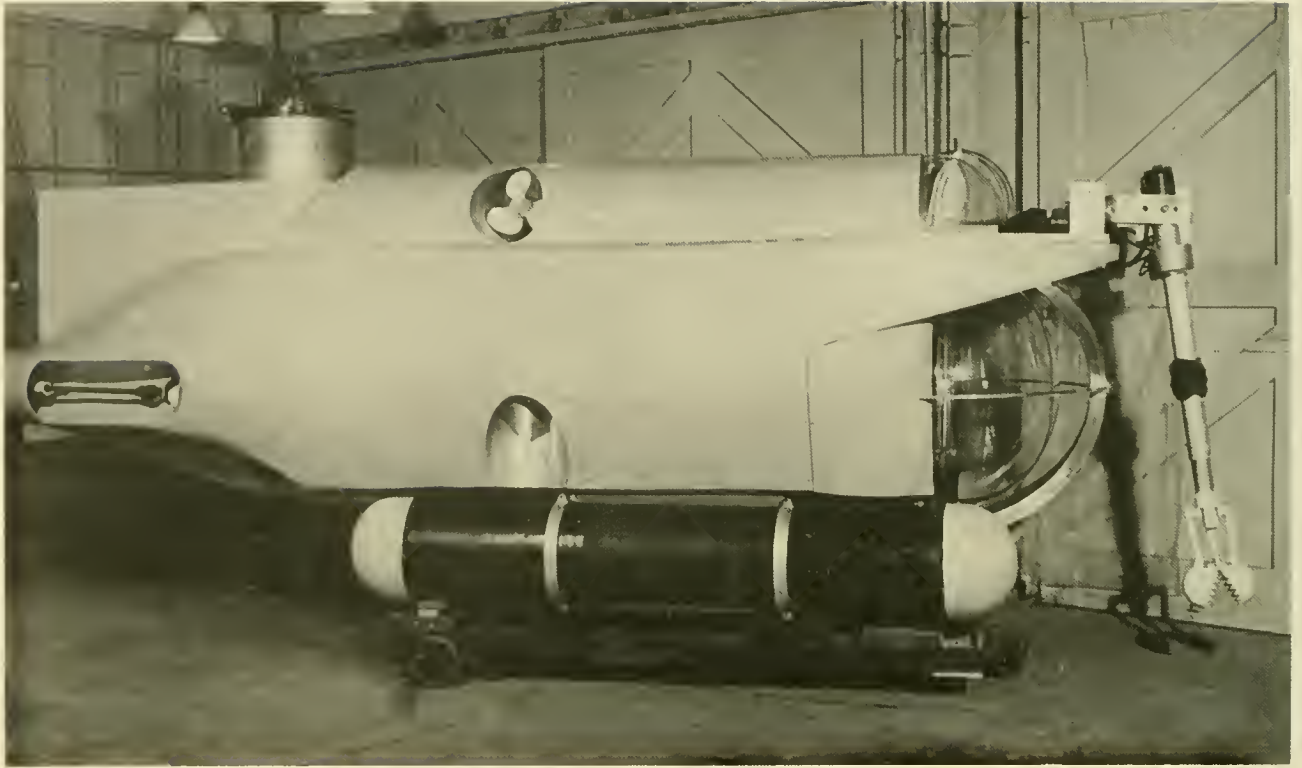



## DEEP VIEW

LENGTH: ..... 16.5 ft  
BEAM: ..... 6 ft  
HEIGHT: ..... 6.5 ft  
DRAFT: ..... 6 ft  
WEIGHT (DRY): ..... 6 tons  
OPERATING DEPTH: ..... 1,500 ft  
COLLAPSE DEPTH: ..... 7,500 ft  
LAUNCH DATE: ..... 1971

HATCH DIAMETER: ..... 20 in.  
LIFE SUPPORT (MAX): ..... 38 man-hr  
TOTAL POWER: ..... 16 kWh  
SPEED (KNOTS): ..... 1/12 hr  
..... 2/6 hr  
..... 4/2 hr  
CREW: PILOTS ..... 1  
OBSERVERS ..... 1  
PAYLOAD: ..... 800 lb (incl. crew)

**PRESSURE HULL:** Cylindrical shape with one hemisphere endcap of glass and one of steel. Hull material and one endcap is HY-100 steel 0.65-in.-thick. Ring stiffened cylindrical pressure hull 6 ft long, 44.5-in. diam. Glass endcap is 1.25-in.-thick Borosilicate weighing 300 lb.

**BALLAST/BUOYANCY:** Forty 5-lb steel plates provide slight buoyancy for initial descent and may be dropped individually during the dive to attain positive buoyancy. Twenty 3-lb buoyancy blocks provide variable buoyancy and are ejectable to attain negative buoyancy.

**PROPULSION/CONTROL:** Five 5-hp, reversible MK 34 torpedo motors (DC). Two are mounted astern for forward and reverse propulsion, one is mounted athwartships to provide lateral thrust, two are mounted amidships on each side to provide vertical thrust. Four degrees of freedom from thrusters plus two degrees by internal ballast trim are attainable.

**TRIM:** Ballast plate drop or buoyancy block ejection for adjustment to buoyancy status. Internal movable ballast for pitch or (infrequently) roll trim. Fore and aft ballast plate drop determines pitch/trim external.

**POWER SOURCE:** Sixteen 6-V, lead-acid batteries connected in series-parallel provide 12, 24 and 48 VDC at 220 amp-hr for main power. Emergency power may be attained from eight 6-V, lead-acid batteries connected in series-parallel to provide 15 amp-hr at 24 VDC. Four auxiliary batteries for switching and environmental control have 2.4-kWh capacity at 24 V.

**LIFE SUPPORT:** Two each, 18-ft<sup>3</sup> tanks of O<sub>2</sub>; two each, 18 ft<sup>3</sup> tanks of scuba air. O<sub>2</sub>, CO<sub>2</sub>, H<sub>2</sub>O, and temperature monitored visually with warning horns on O<sub>2</sub> high and low and CO<sub>2</sub> high. Primary CO<sub>2</sub> removal by LiOH, backed up with Baralyme.

**VIEWING:** Glass hemi-head provides panoramic viewing forward.

**OPERATING/SCIENTIFIC EQUIPMENT:** UQC (8.1-kHz) 4,000-yd range. Two depth gages, lights, echo sounder, VHF radio.

**MANIPULATORS:** None.

**SAFETY FEATURES:** Jettisonable battery pods and ballast plates. Access trunk can be blown for 100-gal displacement (855-lb buoyancy). Emergency batteries internal. Redundancy of blow or pump for access trunk. Flood and go possible with portable scubas.

**SURFACE/SHORE SUPPORT:** SOO.

**OWNER/BUILDER:** U.S. Naval Undersea Center, San Diego, California 92132.

**REMARKS:** Not operating. Certified to 100 ft. Now at Southwest Research Lab.

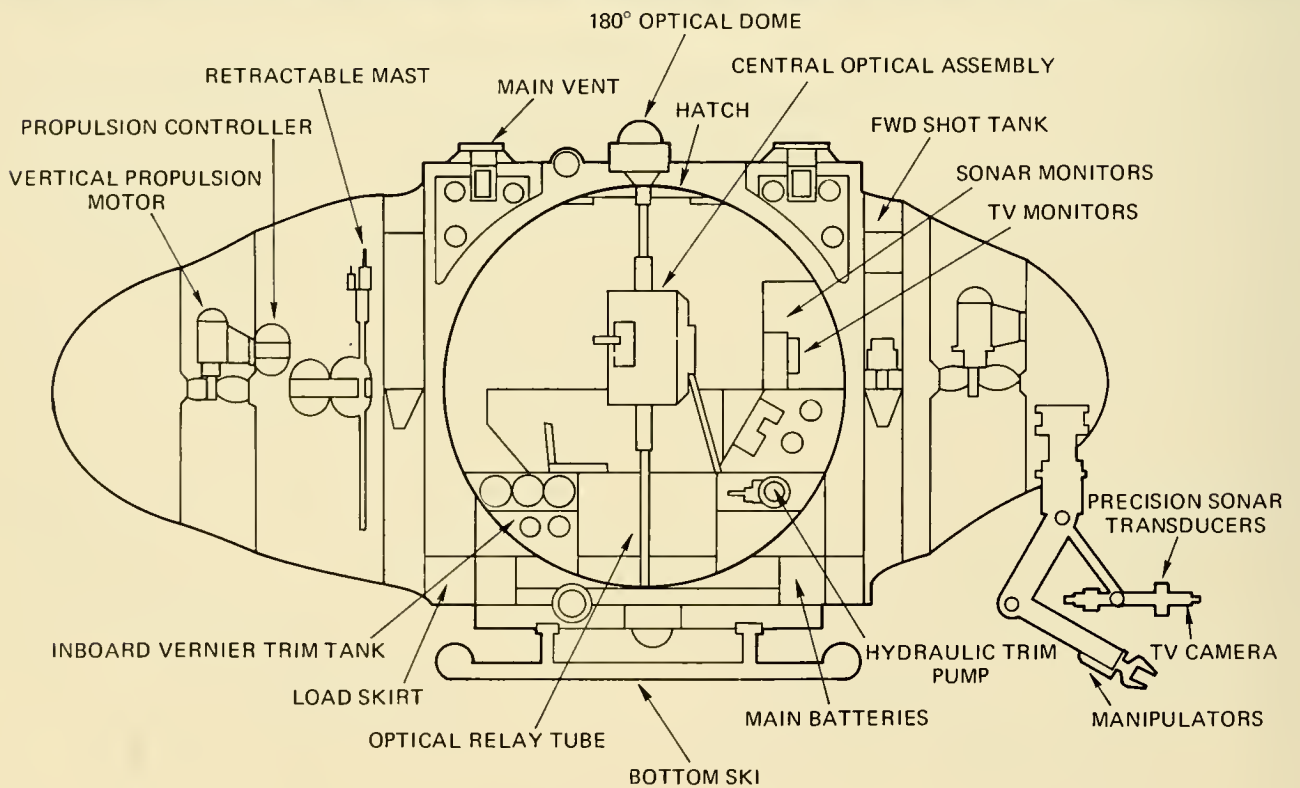

## D O W B

LENGTH: ..... 17 ft  
BEAM: ..... 8.75 ft  
HEIGHT: ..... 11.0 ft  
DRAFT: ..... 5.0 ft  
WEIGHT (DRY): ..... 9.4 tons  
OPERATING DEPTH: ..... 6,500 ft  
COLLAPSE DEPTH: ..... 10,000 ft  
LAUNCH DATE: ..... 1968

HATCH DIAMETER: ..... 20 in.  
LIFE SUPPORT (MAX): ..... 195 man-hr  
TOTAL POWER: ..... 40 kWh  
SPEED (KNOTS): CRUISE ..... 1/26 hr  
MAX ..... 2/6 hr  
CREW: PILOTS ..... 1  
OBSERVERS ..... 2  
PAYLOAD: ..... 580 lb

**PRESSURE HULL:** Spherical shape of HY-100 steel, 82-in. OD and 0.935 in. thick.

**BALLAST/BUOYANCY:** Two water ballast hard tanks are used to provide 3,330 lb of positive buoyancy at the surface. The variable ballast trim system is composed of a hard tank and oil-filled bladders. This system is used primarily to adjust for small changes in displacement, but can be used to adjust for a difference of up to  $\pm 2\frac{1}{2}^\circ$  in trim. This system can achieve a maximum of 512 lb of positive or negative buoyancy. Shot ballast (900 lb) is used for ascending and descending.

**PROPULSION/CONTROL:** Four ducted main propulsion motors provide four degrees of maneuvering freedom, these are: forward and reverse thrust, vertical thrust and yaw. The two horizontal propulsion units are located port and starboard in the plane of the deck, canted outward at  $15^\circ$ . The two vertical thrusters are located fore and aft with their axes normal to the plane of the deck. The propulsion motors deliver 2 SHP to 18-in.-diam. propellers at 486 rpm.

**TRIM:** By transferring oil (used to obtain fine buoyancy control) between fore and aft soft bladders, up/down bow angles of  $\pm 2.5^\circ$  may be obtained.

**POWER SOURCE:** Twenty externally-mounted, pressure-compensated, 12-V, lead-acid batteries provide 43.2 kWh of 120 VDC. This voltage is converted to 115 VAC, 60 Hz, single phase. One auxiliary battery (silver-zinc) provides 1.82 kWh of 30 VDC for emergency use and is located within the pressure hull.

**LIFE SUPPORT:** O<sub>2</sub> (160-scf) is carried within the pressure hull and operates together with the CO<sub>2</sub> removal system which consists of a forced ventilated scrubber stack containing 25 lb of LiOH. Atmospheric monitoring is conducted continuously and automatically by an O<sub>2</sub> concentration indicator, a thermometer, a hydrometer and an aircraft altimeter.

**VIEWING:** Two optical ports located directly amidships and at the bow afford a total coverage of  $360^\circ$  through an internal periscope system. This optical viewing system provides a full 4-pi solid angle visibility through  $180^\circ$ -wide-angle objectives mounted outboard of the viewports.

**OPERATING/SCIENTIFIC EQUIPMENT:** UQC, gyrocompass, scanning sonar, upward-looking and downward-looking Fathometers, closed circuit TV (camera mounted on manipulator), video tape recorder.

**MANIPULATORS:** One manipulator possessing six degrees of freedom can pick up a 50-lb load at its maximum reach of 49 in.

**SAFETY FEATURES:** Emergency breathing system consisting of closed circuit breathing connected to main O<sub>2</sub>/CO<sub>2</sub> removal system. The following components are droppable: shot ballast, batteries, pan and tilt mechanism.

**SURFACE/ShORE SUPPORT:** Was supported at sea by the R/V SWANN, a 135-ft (LOA), 250-ton displacement ex-U.S. Navy patrol craft.

**OWNER:** Santa Barbara City College, Santa Barbara, California.

**BUILDER:** A.C. Division, General Motors Corp., Santa Barbara, California.

**REMARKS:** Inactive. Used for student training.

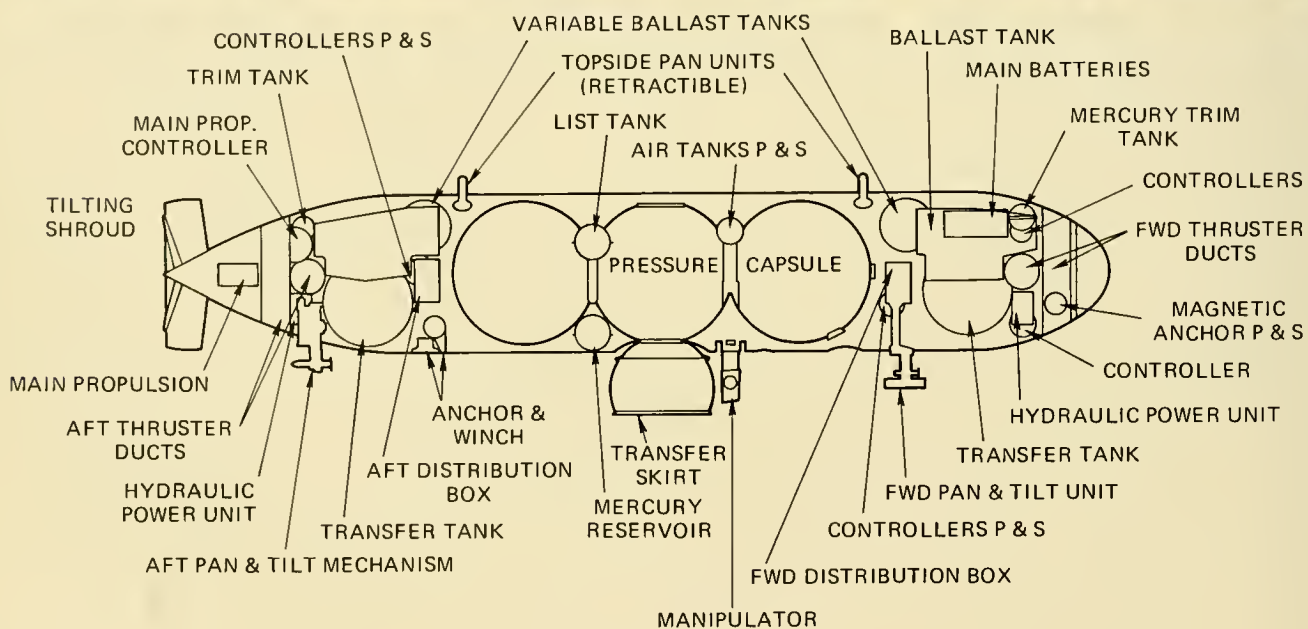
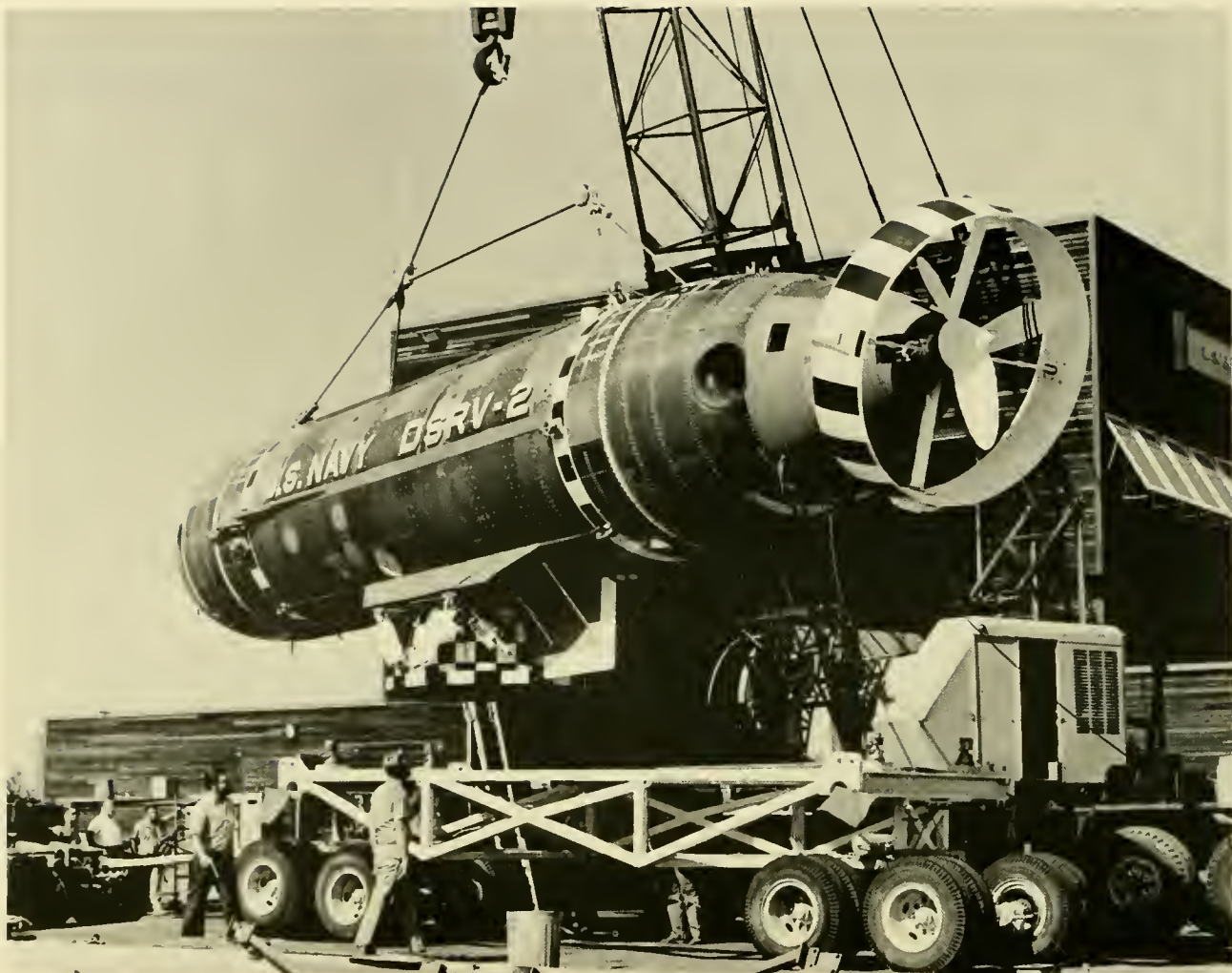

## DSRV-1 & 2 (DEEP SUBMERGENCE RESCUE VEHICLE)

LENGTH: .....	49.3 ft	HATCH DIAMETER: .....	25 in.
BEAM: .....	8.1 ft	LIFE SUPPORT (MAX): .....	729 man-hr
HEIGHT: .....	11.4 ft	TOTAL PDWER: .....	58 kWh
DRAFT: .....	10.75 ft	SPEED (KNOTS): CRUISE .....	3/12 hr
WEIGHT (DRY): .....	37.35 tons	MAX .....	4.5/3 hr
OPERATING DEPTH: .....	5,000 ft	CREW: PILOTS .....	3
COLLAPSE DEPTH: .....	7,500 ft	OBSERVERS .....	24 (Rescuees)
LAUNCH DATE: .....	1970 & 1971	PAYLOAD: .....	4,320 lb

**PRESSURE HULL:** Three 7.5-ft diam., 0.738-in.-thick, interconnected, HY-140 steel spheres contained within a formed fiberglass fairing. Forward sphere is for operators; aft spheres are for rescuees (24 total). Two hatches are in mid-sphere; one topside is for surface access, one on bottom enclosed by skirt is for rescuees to enter.

**BALLAST/BUOYANCY:** Four saddle tanks (748 gal—6,400 lb total) provide freeboard on surface. Fore and aft tanks (123.4 gal—1,060 lb total) provide variable buoyancy control. Four collapsible bags in each sphere (478 gal—4,080 lb total) compensate for weight of rescuees. Fore and aft tanks (713.6 gal—5,664 lb total) are used to store water pumped from rescue skirt.

**PROPULSION/CONTROL:** Forward propulsion by a stern-mounted, reversible 4-ft diam. propeller driven by a 15-hp, AC motor. Two each vertical and horizontal ducted thrusters (fore- & aft-mounted), each driven by a 7.5-hp, AC, electric motor. Shroud around stern propeller can be tilted to control yaw and pitch.

**TRIM:** Up and down bow angles can be obtained by transferring part of the 1,428 lb of mercury carried in forward/aft tanks (36.5 gal total). Port and starboard tanks located above centerline provide list control by transferring 6 gal of mercury (440 lb). A similar tank located low on the centerline amidships can control BG by mercury transfer from list tanks.

**POWER SOURCE:** Two pressure-compensated, silver-zinc batteries weighing 2,000 lb each supply 56 kWh apiece at 112 VDC for main propulsion. A similar system plus inverters and converter are available for  $\pm 28$  VDC and 115 VAC at 400 cycle. A 28-VDC silver-zinc battery (115 kWh) is available for emergency.

**LIFE SUPPORT:** Separate support for forward sphere and mid/aft spheres. CO<sub>2</sub> is controlled by LiDH. Closed loop emergency breathing systems are available for 28 people. An air conditioning system controls humidity and heat.

**VIEWING:** Five viewports are available. Two in the forward sphere (4-in. diam.), one looks forward and down 30°, one looks 140° to starboard and 30° down from the horizontal. Two (4-in. diam.) in mid-sphere look 70° to port and starboard and 50° down from the horizontal. One in mid-sphere lower hatch looks directly down and is 3 in. in diam.

**OPERATING/SCIENTIFIC EQUIPMENT:** UQC (8.087-kHz), CTFM sonar, vertical sonar, altitude/depth sonar, Doppler sonar navigator, sound velocimeter, tracking transponder for DSRV, transponder navigation system, two TV cameras, side scan sonar, 16-mm cine camera, two 35-mm still cameras.

**MANIPULATORS:** One manipulator with seven degrees of freedom on forward sphere.

**SAFETY FEATURES:** The following is jettisonable: Manipulator, downhaul winch cable, pan and tilt camera units, magnetic anchors.

**SURFACE/SHORE SUPPORT:** Air, ship, truck, submarine transportable.

**OWNER:** U.S. Navy Submarine Development Group One, San Diego, California.

**BUILDER:** Lockheed Missiles & Space Corp., Sunnyvale, California.

**REMARKS:** Undergoing test and evaluation. Both vehicles are built to the same specifications. DSRV-1 is presently rated at 3,500 ft, but will eventually reach the 5,000-ft operating depth of DSRV-2.



## FNRS - 2

LENGTH: ..... 22.75 ft  
BEAM: ..... 10.4 ft  
HEIGHT: ..... 18.9 ft  
DRAFT: ..... 10 ft  
WEIGHT (DRY): ..... 28 tons  
OPERATING DEPTH: ..... 13,500 ft  
COLLAPSE DEPTH: ..... 20,000 ft  
LAUNCH DATE: ..... 1948

HATCH DIAMETER: ..... 16.9 in. ID; 21.65 in. OD  
LIFE SUPPORT (MAX): ..... 100 man-hr  
TOTAL POWER: ..... NA  
SPEED (KNOTS): CRUISE ..... 0.2 knots  
MAX ..... NA  
CREW: PILOTS ..... 1  
OBSERVERS: ..... 1  
PAYLOAD: ..... NA

**PRESSURE HULL:** Spherical shape composed of two hemispheres cast of Ni-Cr-Mo steel 6 ft 7 in. OD, 3.54 in. thick reinforced to 5.91 in. at viewports and held together with clamps along an equatorial ring. Weight in air of 10 tons.

**BALLAST/BUOYANCY:** Positive buoyancy is obtained by 6,600 gal (1,059 ft<sup>3</sup>) of gasoline contained in six upright, cylindrical tanks within a 22.75x10.4x13-ft, 0.04-in.-thick, iron float. Approximately 8 tons of gravel, scrap iron and iron shot are electromagnetically held to provide negative buoyancy; the iron shot may be dropped incrementally. A "horsetail" of thin cables serves as a near-bottom guiderope and fine buoyancy control.

**PROPULSION/CONTROL:** Two electric motors (1-hp each) are mounted topside port/starboard and drive the vehicle forward or reverse.

**TRIM:** No systems available.

**POWER SOURCE:** One externally-mounted, pressure-compensated, droppable, lead-acid battery of 14 cells and 900 amp-hr supplies primary power. A reserve battery of 120 cells is also carried. Both batteries are electromagnetically held below the float.

**LIFE SUPPORT:** O<sub>2</sub> is carried in the pressure sphere and released into the cabin automatically. Cabin air is blown through soda-lime cartridges to remove CO<sub>2</sub>. Humidity is reduced by silica gel.

**VIEWING:** Two viewports, each is 5.91 in. thick, 15.75-in. OD, 3.94-in. ID. One looks downward from the vertical (about 30°) and forward. The second is in the entrance hatch and looks aft, upward toward the float.

**OPERATING/SCIENTIFIC EQUIPMENT:** Tachometer for vertical speed, pressure gage.

**MANIPULATORS:** None.

**SAFETY FEATURES:** Snorkel for breathing when surfaced. Batteries (2,650 lb) and all ballast droppable.

**SURFACE/SHORE SUPPORT:** Can be transported aboard ship and launched/retrieved at sea. Normally it is towed to dive site.

**OWNER:** French Navy.

**BUILDER:** Auguste Piccard, with funds from the Belgium National Fund for Scientific Research (FNRS).

**REMARKS:** Reconfigured to FNRS-3 by the French Navy in 1949-1953 after severe damage to float while in tow during heavy weather.

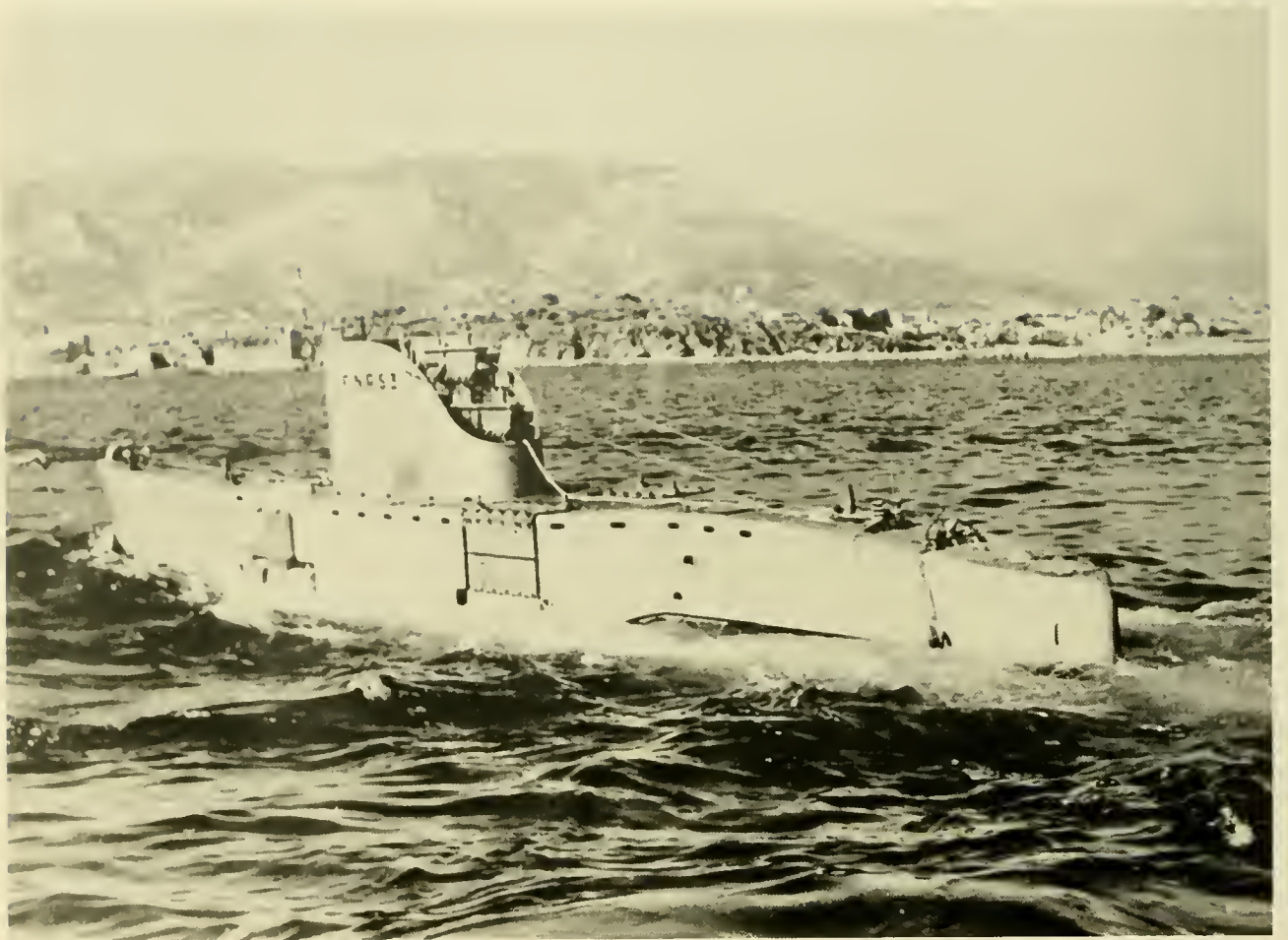



## FNRS - 3

LENGTH: ..... 52.5 ft  
 BEAM: ..... 11.1 ft  
 HEIGHT: ..... NA  
 DRAFT: ..... NA  
 WEIGHT (DRY): ..... 28.1 tons  
 OPERATING DEPTH: ..... 13,500 ft  
 COLLAPSE DEPTH: ..... 20,000 ft  
 LAUNCH DATE: ..... 1953

HATCH DIAMETER: ..... 16.94 in.  
 LIFE SUPPORT (MAX): ..... 48 man-hr  
 TOTAL POWER: ..... 30 kWh  
 SPEED (KNOTS): CRUISE ..... NA  
                   MAX ..... 5  
 CREW: PILOTS ..... 1  
           OBSERVERS ..... 1  
 PAYLOAD: ..... NA

**PRESSURE HULL:** Spherical shape composed of cast Ni-Cr-Mo steel 6-ft 10-in. OD and ranging in thickness 3.5 in. to 5.9 in.

**BALLAST/BUOYANCY:** Positive buoyancy provided by 2,794 ft<sup>3</sup> of gasoline carried in 11 tanks within a thin-walled float. Negative buoyancy provided by 4,000 lb of steel shot electromagnetically held in four tanks.

**PROPULSION/CONTROL:** Two 2-hp, reversible, DC motors provide both main propulsion and steering control.

**TRIM:** No systems provided.

**POWER SOURCE:** Two 28-V, pressure-compensated, lead-acid batteries supply 900 amp-hr for lights and motors, One 28-V, silver-zinc battery supplies 180 amp-hr for all other equipment.

**LIFE SUPPORT:** Four O<sub>2</sub> cylinders carried within the hull. CO<sub>2</sub> is removed by soda lime.

**VIEWING:** Same as FNRS-2.

**OPERATING/SCIENTIFIC EQUIPMENT:** UQC, echo sounder, depth gage, radio transceiver, compass, seawater sampler and temperature sensor, still camera.

**MANIPULATORS:** None.

**SAFETY FEATURES:** All steel shot is automatically dumped upon loss of electrical power. Batteries also drop upon loss of electrical power (2,600 lb).

**SURFACE SUPPORT:** Towed on surface.

**OWNER:** French Navy.

**BUILDER:** French Naval Shipyard, Toulon.

**REMARKS:** Inactive, retired in 1960. Deepest depth reached was 13,500 ft. The two major differences between FNRS-2 and 3 was that FNRS-3's float was designed for surface towing and the occupants of FNRS-3 could enter the pressure hull while the vehicle was on the surface through an access trunk which ran through the float to the hull.

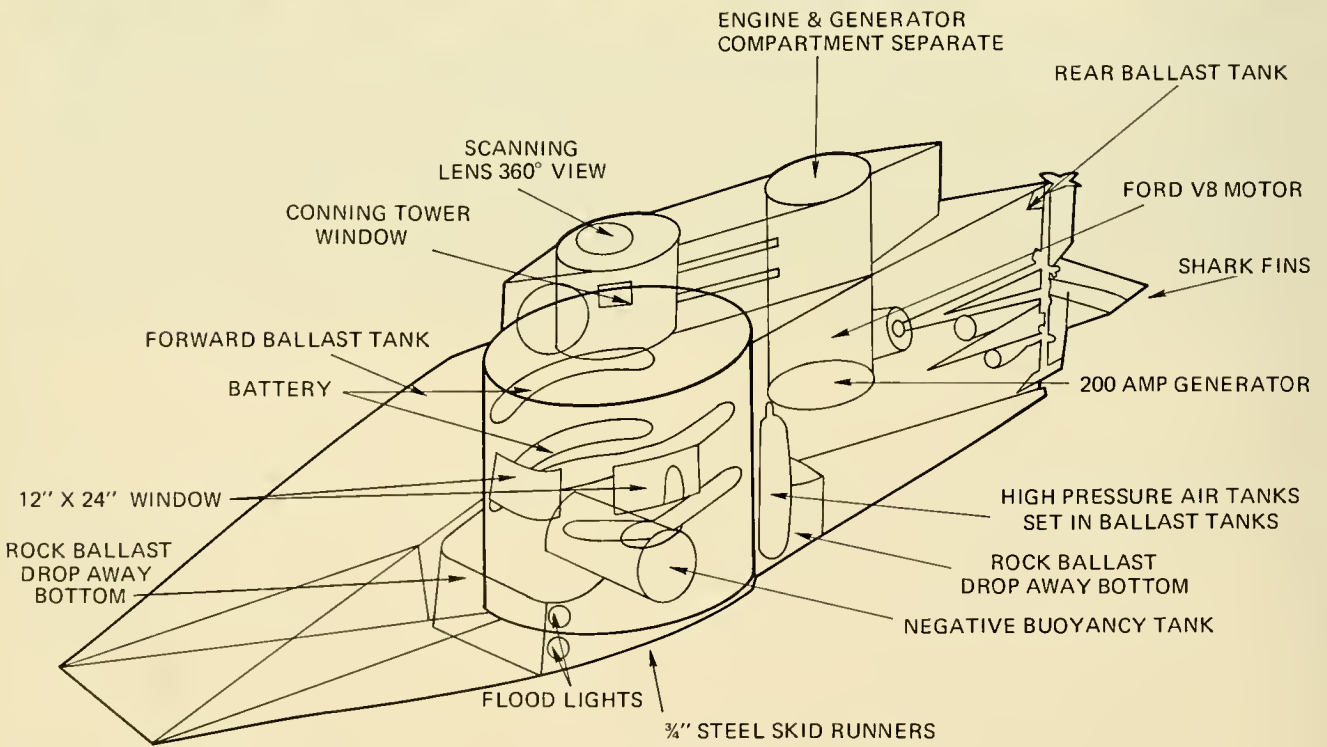

## GOLDFISH

LENGTH: ..... 28.7 ft  
BEAM: ..... 6.5 ft  
HEIGHT: ..... 8.7 ft  
DRAFT: ..... 4.0 ft  
WEIGHT (DRY): ..... 6.25 tons  
OPERATING DEPTH: ..... 100 ft  
COLLAPSE DEPTH: ..... 320 ft  
LAUNCH DATE: ..... 1958

HATCH DIAMETER ..... 32 in.  
LIFE SUPPORT (MAX): ..... 18 man-hr  
TOTAL POWER: ..... 1,200 amp-hr  
SPEED (KNOTS): CRUISE ..... NA  
MAX ..... 5/5 hr  
CREW: PILOTS ..... 1  
OBSERVERS ..... 3  
PAYLOAD: ..... 1,000 lb

**PRESSURE HULL:** Shaped as an inverted wedge and composed of 0.25-in.-thick steel plate with 4-in.-thick seamless steel ribs, "I" beams and 0.25-in. plates mounted at angles.

**BALLAST/BUOYANCY:** Two main ballast tanks, one forward and one aft and one negative buoyancy tank in the center. Five 122-ft<sup>3</sup> capacity air flasks are used to blow water ballast. A low pressure air pump is used to adjust buoyancy on the surface.

**PROPULSION/CONTROL:** Main propulsion is provided by two propellers mounted port/starboard on the stern. Lateral thrust is provided by two propellers mounted athwartships on the bow.

**TRIM:** No systems provided.

**POWER SOURCE:** Surface power is derived from a Ford '60 V8 engine which provides direct drive to the main propulsion units. Submerged power is derived from eight 60-amp-hr and sixteen 45-amp-hr lead-acid batteries. A 200-amp generator is carried within the vehicle to charge batteries on the surface.

**LIFE SUPPORT:** NA.

**VIEWING:** Three 12 in. x 24 in. viewports on main pressure hull. Two 6-in.<sup>2</sup> viewports on conning tower. One 18-in.-diam. lens in hatch cover providing 360° viewing.

**OPERATING/SCIENTIFIC EQUIPMENT:** CB radio, cameras, sonar.

**MANIPULATORS:** None.

**SAFETY FEATURES:** Droppable ballast. Pressure hull can be pressurized to ambient by introducing deballasting air into hull for egress of occupants through removable windows.

**SURFACE SUPPORT:** None.

**OWNER:** Unknown.

**BUILDER:** Burtis L. Dickman, Auburn, Indiana

**REMARKS:** Sold in 1973. Was due to be rebuilt by new owner. Present status unknown.

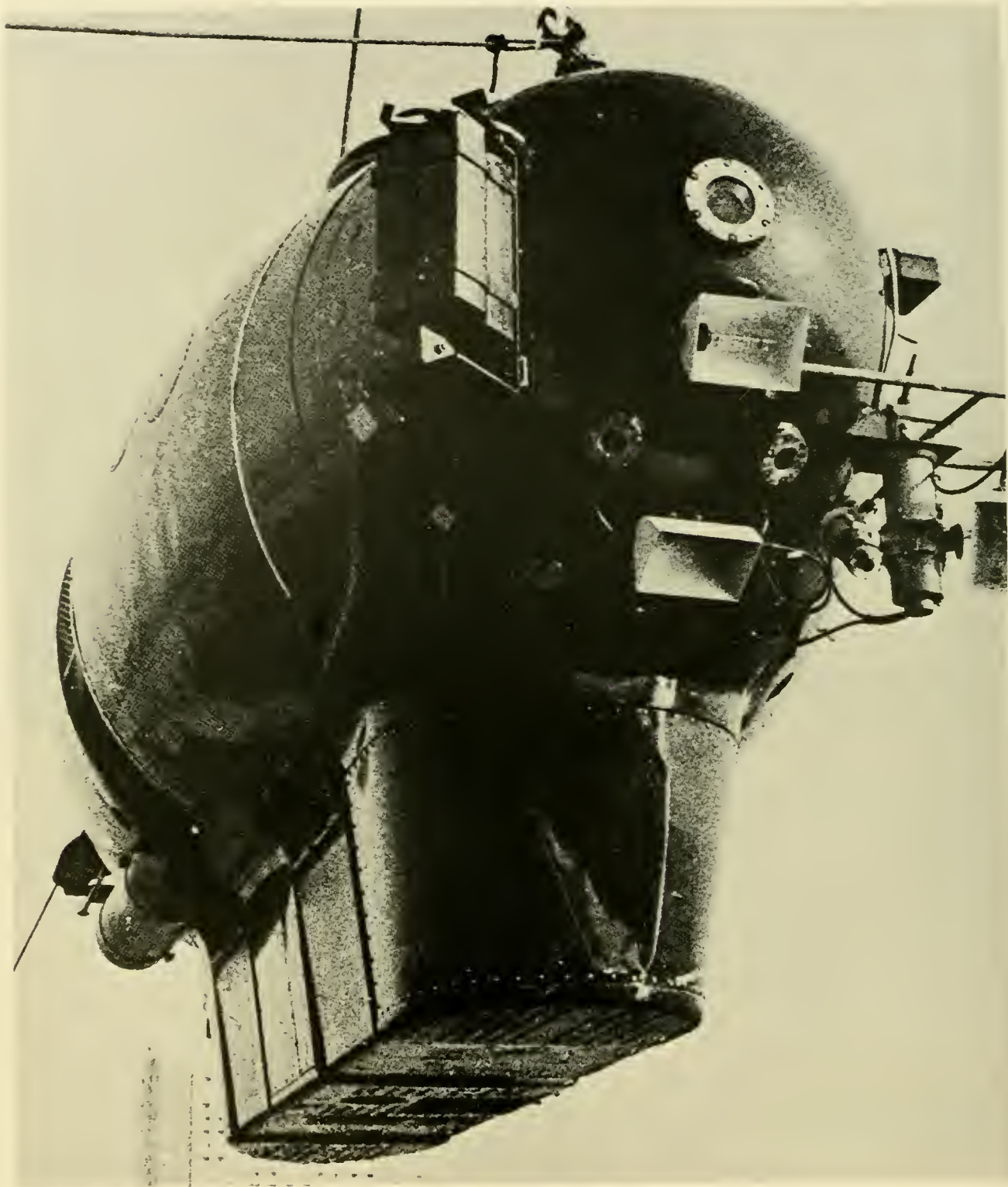

## GRIFFON

LENGTH: .....	7.4 m	HATCH DIAMETER: .....	NA
BEAM: .....	2.1 m	LIFE SUPPORT (MAX): .....	100 man-hr
HEIGHT: .....	3.1 m	TOTAL POWER: .....	NA
DRAFT: .....	NA	SPEED (KNOTS): CRUISE .....	NA
WEIGHT (DRY): .....	12 tons	MAX .....	4/6 hr
OPERATING DEPTH: .....	600 m	CREW: PILOTS .....	2
COLLAPSE DEPTH: .....	NA	OBSERVERS .....	1
LAUNCH DATE: .....	1973	PAYLOAD: .....	200 kg

**PRESSURE HULL:** Central cylinder with an OD of 1.60 m capped with a forward cone closed by a hemispherical cap and after cone through which shafting penetrates. Hull is composed of 210-mm-thick steel.

**BALLAST/BUOYANCY:** Four main ballast tanks of 2.4-m<sup>3</sup> capacity blown by compressed air. Gross pre-dive ballasting is adjusted by the removal or addition of lead weights on the keel. Submerged buoyancy is adjusted by fore and aft variable ballast tanks within the hull which allow a total adjustment of 130 kg. An anchoring device consisting of 20 m of cable and a 200-kg anchor allows vertical hovering control near-bottom.

**PROPULSION/CONTROL:** One, three-bladed propeller at the stern (5-hp) provides main propulsion. Two vertical thrusters and one lateral thruster all of 0.5 hp.

**TRIM:** Up/down bow angles can be obtained by transferring fresh water between two forward and two aft tanks within the pressure hull.

**POWER SOURCE:** Nickel-cadmium batteries are located in jettisonable pods outside the hull. The batteries are pressure compensated and provide all electrical power. A 28-V battery within the hull is for emergency power.

**LIFE SUPPORT:** Gaseous O<sub>2</sub>. CO<sub>2</sub> is removed by soda lime. Monitors for O<sub>2</sub>, CO<sub>2</sub> and cabin pressure. Three individual emergency breathing apparatuses are connected to the main O<sub>2</sub> supply.

**VIEWING:** Five viewports. One is in the access trunk and four are on the pressure hull bow.

**OPERATING/SCIENTIFIC EQUIPMENT:** UQC (Straza ATM 504 A) which also operates as a transponder interrogator, an echo sounder, a pinger and a transponder. Depth gage, TV, VHF radio, gyrocompass, two recording echo sounders, sample basket.

**MANIPULATORS:** One, with a reach of 1.60 m.

**SAFETY FEATURES:** Battery pods and manipulator are jettisonable (total about 900 kg). Anchor cable can be cut with a pyrotechnic device. Two fire extinguishers.

**SURFACE SUPPORT:** Supported by the ship TRITON which may either tow it to the dive site or launch/retrieve it on station.

**OWNER:** Operated by the Groupe d'Etudes et de Recherches Sous-marines (GERS) and the French Navy.

**BUILDER:** French Naval and Construction yard, Brest.

**REMARKS:** Undergoing sea trials as of February 1974.

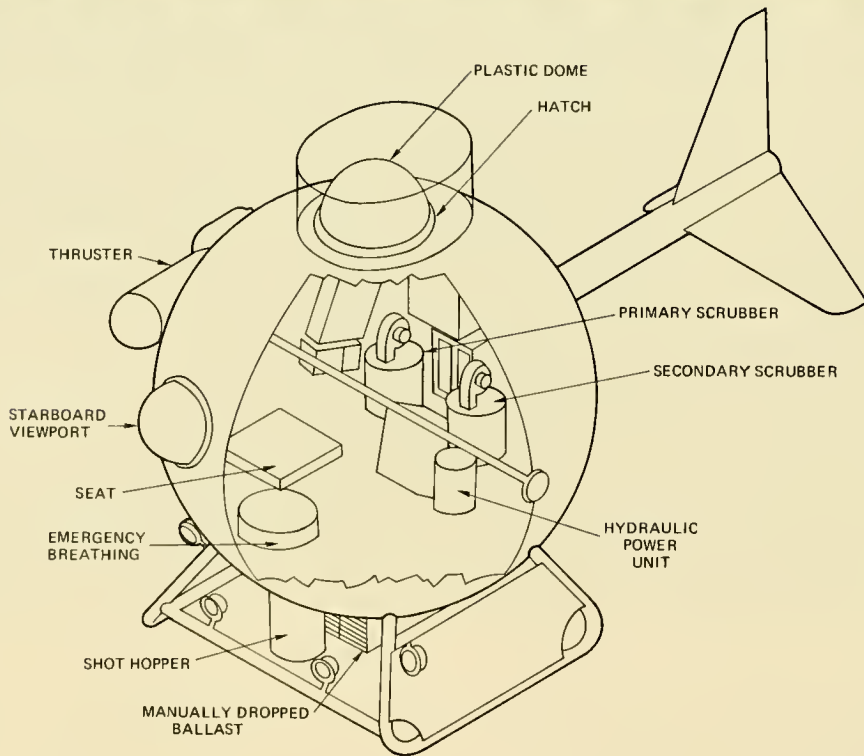
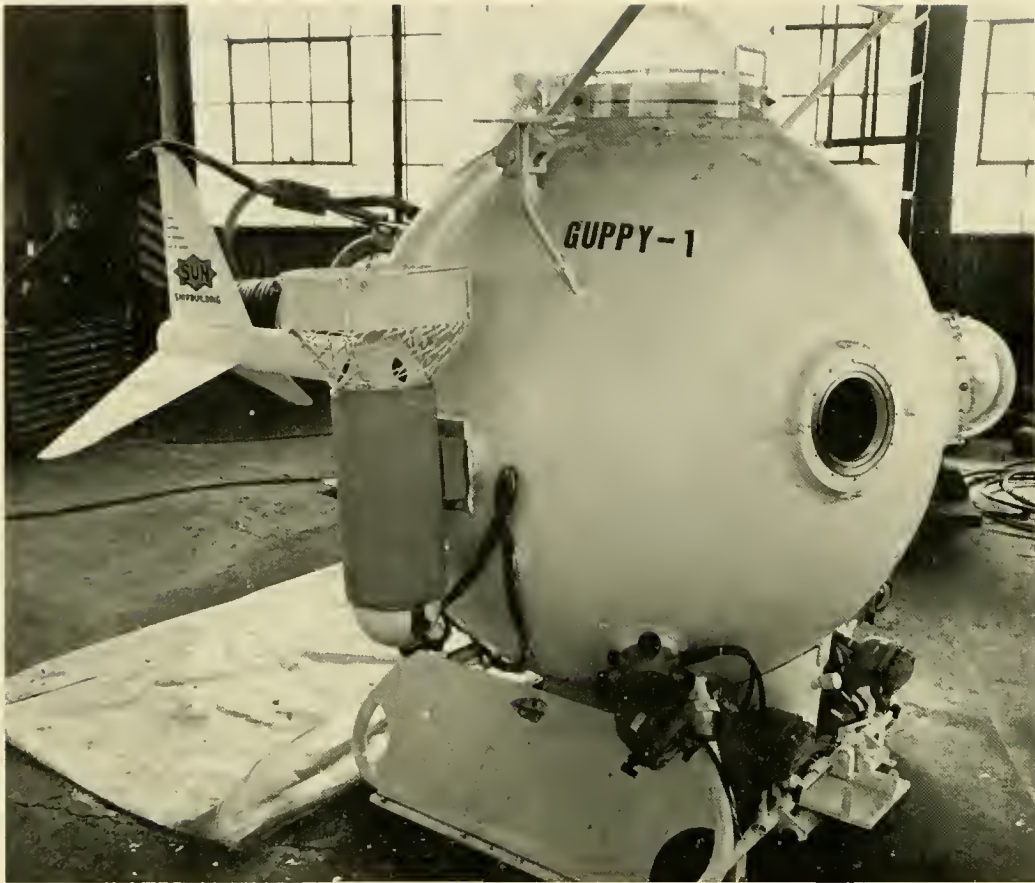

## GUPPY

LENGTH: ..... 11 ft  
BEAM: ..... 8 ft  
HEIGHT: ..... 7.5 ft  
DRAFT: ..... 5.6 ft  
WEIGHT (DRY): ..... 2.5 tons  
OPERATING DEPTH: ..... 1,000 ft  
COLLAPSE DEPTH: ..... 2,000 ft  
LAUNCH DATE: ..... 1970

HATCH DIAMETER: ..... 20 in.  
LIFE SUPPORT (MAX): ..... 72 man-hr  
TOTAL POWER: ..... tethered  
SPEED (KNOTS): CRUISE ..... 1  
                  MAX ..... 3  
CREW: PILOTS, ..... 1  
      OBSERVERS ..... 1  
PAYLOAD: ..... 850 lb

**PRESSURE HULL:** Spherical shape of HY-100 steel 66-in. ID and 0.5 in. thick.

**BALLAST/BUOYANCY:** An internal, variable ballast tank controls surface draft and main  $\pm$  buoyancy. Two lead shot hoppers (150 lb each) provide negative buoyancy and a 400-lb weight in the keel provides additional negative buoyancy.

**PROPULSION/CONTROL:** Two port-starboard mounted 10-hp, 440-VAC, 1,140/560 rpm, reversible and rotatable ( $180^\circ$  in the vertical) motors provide lateral and vertical maneuvering.

**TRIM:** Fore and aft shot hoppers may be differentially emptied to obtain up/down bow angles.

**POWER SOURCE:** Derived from 440-V surface generator through a 35-kW cable.

**LIFE SUPPORT:** O<sub>2</sub> cylinders carried within the hull. O<sub>2</sub>, CO<sub>2</sub> and temperature/humidity gages are also carried.

**VIEWING:** Three viewports one 16-in. diam., 1.25-in.-thick, hemispherical viewport is incorporated into the access hatch. Two 8-in.-diam., 1-in.-thick, hemispherical ports look forward on the centerline.

**OPERATING/SCIENTIFIC EQUIPMENT:** Hard line telephone, depth gage, inclinometer, corer.

**MANIPULATORS:** None.

**SAFETY FEATURES:** Mechanically releasable weight (400 lb). Shot hoppers can be emptied (300 lb). Vehicle can be retrieved by its power cable. Sixteen man-hr emergency breathing, fire extinguisher, surface flashing light.

**SURFACE SUPPORT:** SOO.

**OWNER:** Sun Shipbuilding and Dry Dock Co., Chester, Penna.

**BUILDER:** Same as Owner.

**REMARKS:** Has not operated for several years.

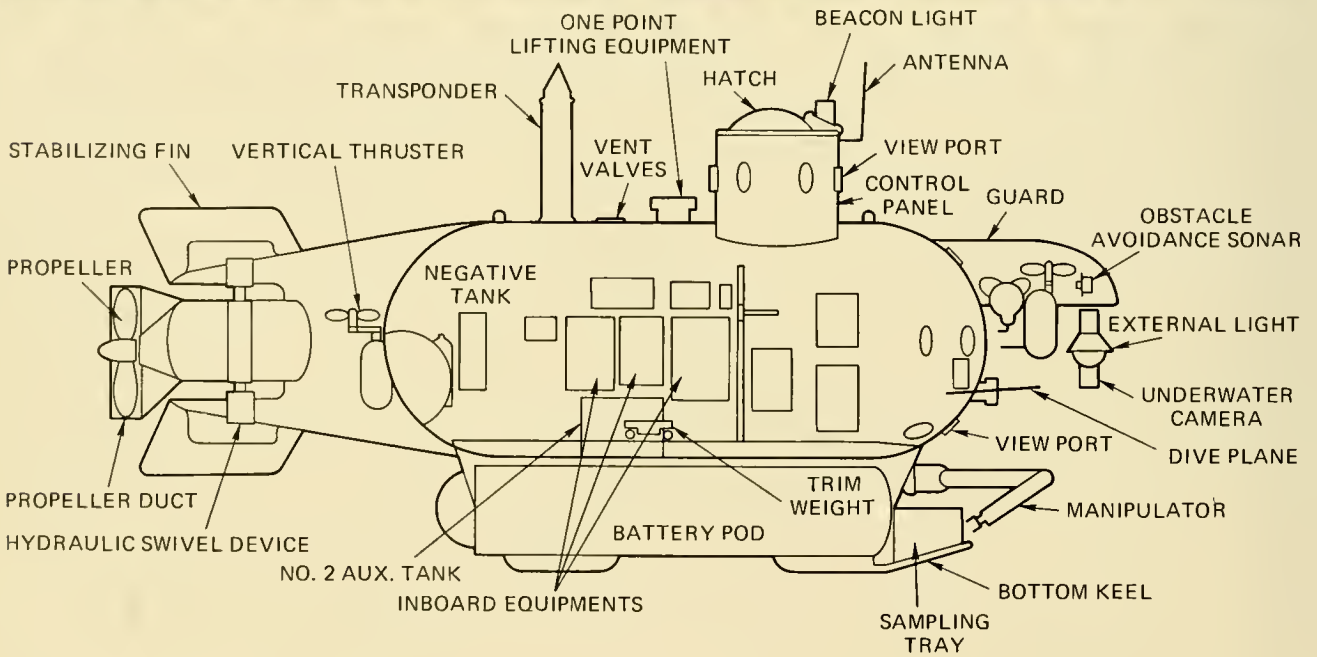
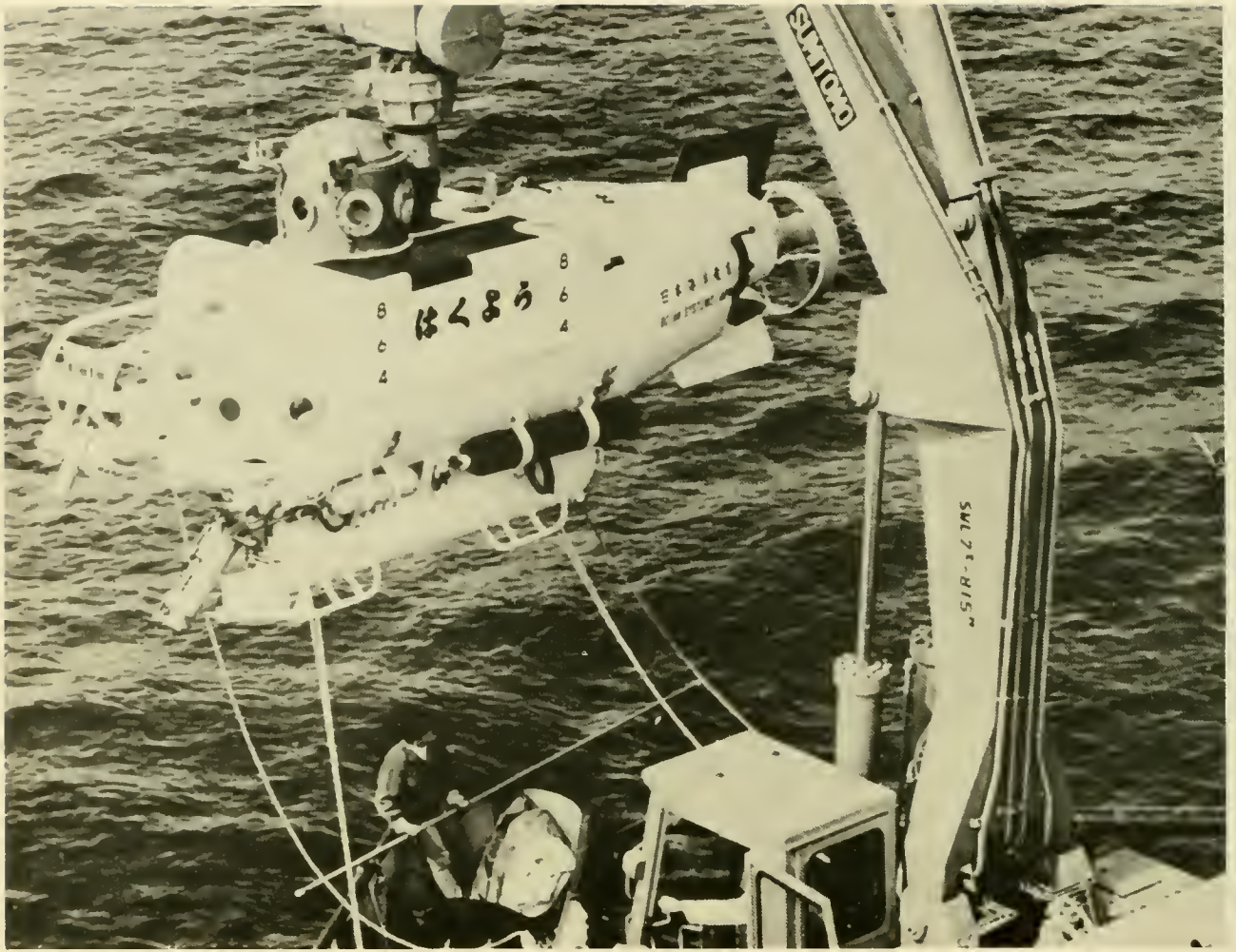



## HAKUYO

LENGTH: ..... 4.7 m  
BEAM: ..... 1.7 m  
HEIGHT: ..... 2.0 m  
DRAFT: ..... 1.9 m  
WEIGHT (DRY): ..... 6 tons  
OPERATING DEPTH: ..... 300 m  
COLLAPSE DEPTH: ..... 450 m  
LAUNCH DATE: ..... 1971

HATCH DIAMETER: ..... 62 cm  
LIFE SUPPORT (MAX): ..... 144 man-hr  
TOTAL POWER: ..... 14.4 kWh  
SPEED (KNOTS): CRUISE ..... 1/5 hr  
MAX ..... 3/5 hr  
CREW: PILOTS ..... 1  
OBSERVERS ..... 3  
PAYLOAD: ..... NA

**PRESSURE HULL:** Cylindrical shape of quenched and tempered, high tensile NS46 (Japan Defense Agency Standard) steel. Hull is 1.4 m in diam. and cylinder is 12.5 mm thick, endcaps are 13.5 mm thick.

**BALLAST/BUOYANCY:** Vehicle is made negatively buoyant by letting seawater into the auxiliary tank and pumping out to become positive. A negative tank is used to obtain greater negative buoyancy when sitting on the bottom.

**PROPULSION/CONTROL:** A stern-mounted propeller (trainable 90° left or right) provides main fore/aft propulsion and is driven by a 10-hp motor. A horizontal thruster, driven by a 1-hp motor is mounted on the bow and 0.5-hp vertical thrusters (1 each) are mounted on bow and stern. Diving planes are mounted on the bow to provide underway vertical control.

**TRIM:** A lead weight is moved along a rail at the bottom and inside the pressure hull by a hydraulic motor. Up/down bow angles of 10° are obtainable.

**POWER SOURCE:** Two lead-acid battery systems are carried in a ring-stiffened cylindrical shell (battery pod) beneath the pressure hull. A 120-V system supplies power to all propulsion units, hydraulic pump and lights. A 24-V system powers acoustic equipments, compass and indicators.

**LIFE SUPPORT** A high-pressure flask mounted outside the pressure hull carries the O<sub>2</sub> supply. Baralyme is used to absorb CO<sub>2</sub>, silica gel is used to reduce humidity. A Drager gas analyzer is used to monitor the interior atmosphere.

**VIEWING:** Eight viewports are incorporated into the forward endcap, six are arranged around the conning tower. A 90° view is obtainable through the viewports which have an ID of 150 mm.

**OPERATING/SCIENTIFIC EQUIPMENT:** UQC (9-kHz), obstacle avoidance sonar, up/down echo sounders, radio, pinger, transponder.

**MANIPULATORS:** One manipulator capable of five degrees of freedom.

**SAFETY FEATURES:** Auxiliary and negative buoyancy tanks can be blown in an emergency. Battery pod of 250 kg is droppable. Manipulator wrist detaches when its applied load exceeds 50 kg. Emergency breathing apparatus is carried in the pressure hull which draws off of the main air supply. Fire extinguisher, flashing surface lights.

**SURFACE SUPPORT:** SOO.

**OWNER:** Ocean Systems Japan Ltd., Tokyo.

**BUILDER:** Kawasaki Heavy Industries, Ltd., Tokyo.

**REMARKS:** Operational.

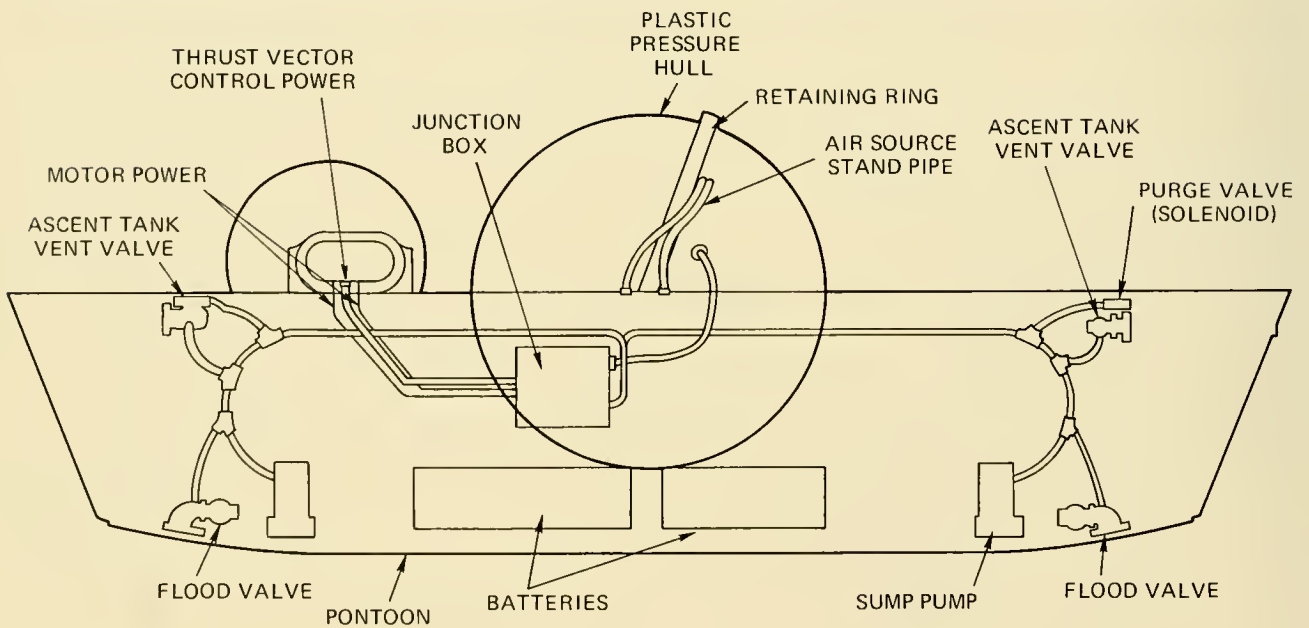

## HIKINO

LENGTH: ..... 16 ft  
BEAM: ..... 8 ft  
HEIGHT: ..... 5.5 ft  
DRAFT: ..... 2.1 ft  
WEIGHT (DRY): ..... 5,700 lb  
OPERATING DEPTH: ..... 20 ft  
COLLAPSE DEPTH: ..... 30 ft  
LAUNCH DATE: ..... 1966

HATCH DIAMETER: ..... none  
LIFE SUPPORT (MAX): ..... 48 man-hr  
TOTAL POWER: ..... 2.3 kWh  
SPEED (KNOTS): CRUISE ..... 0.9  
MAX ..... 3.5/45 min.  
CREW: PILOTS ..... 1  
OBSERVERS ..... 1  
PAYLOAD: ..... NA

**PRESSURE HULL:** Spherical shape of two 56-in. OD plastic hemispheres 0.25 in. thick. The two hemispheres were hinged together by an aluminum flange and opened to allow entry of personnel. The catamaran hull was constructed of marine plywood, covered with fiberglass and sealed with paint.

**BALLAST/BUOYANCY:** Lead ballast weights (1,750 lb) gave the vehicle neutral buoyancy at launch. Total buoyancy was a function of trapped air, water absorption, personnel and equipment weight. The pressure sphere furnished about 3,160 lb positive buoyancy. Floodable tanks at each end of both pontoons were vented to obtain negative buoyancy. Normally the vehicle dived 10 lb heavy, but over mud bottom it was 10 lb light to decrease stirring of mud.

**PROPULSION/CONTROL:** Two 1.4-hp, DC motors powered cycloidal propellers forward of pressure sphere and capable of swiveling 90° up or down.

**TRIM:** None.

**POWER SOURCE:** Twenty 6-V, 190-amp-hr, lead-acid batteries are carried in two containers in the catamaran hull. The batteries are exposed to water and ambient pressure; to protect them, the terminals were coated with rubber cement, most of the air was displaced by the electrolyte, cells were modified to prevent gas trapping and pressure relief valves were screwed into filler holes of each cell. Voltages supplied were 18 VDC and 24 VDC.

**LIFE SUPPORT:** Gaseous O<sub>2</sub> (514 in.<sup>3</sup> at 1800 psi) was carried in the pressure sphere and metered out automatically at 2 SCFH. LiOH was employed in a 10-SCFM blower circuit to remove CO<sub>2</sub>. Silica gel was used to decrease humidity.

**VIEWING:** Panoramic viewing through plastic hull.

**OPERATING/SCIENTIFIC EQUIPMENT:** NA.

**MANIPULATORS:** None.

**SAFETY FEATURES:** Two scuba tanks and regulators carried in the pressure hull for emergency breathing or to exit vehicle after flooding.

**SURFACE SUPPORT:** Not applicable.

**OWNER:** Naval Weapons Center, China Lake, Calif.

**BUILDER:** Same as above.

**REMARKS:** HIKINO was an experimental vehicle (called a Mock-Up) used to gain experience with plastic hulls; this experience led to development of NEMO, DEEP VIEW, and other plastic-hulled submersibles.

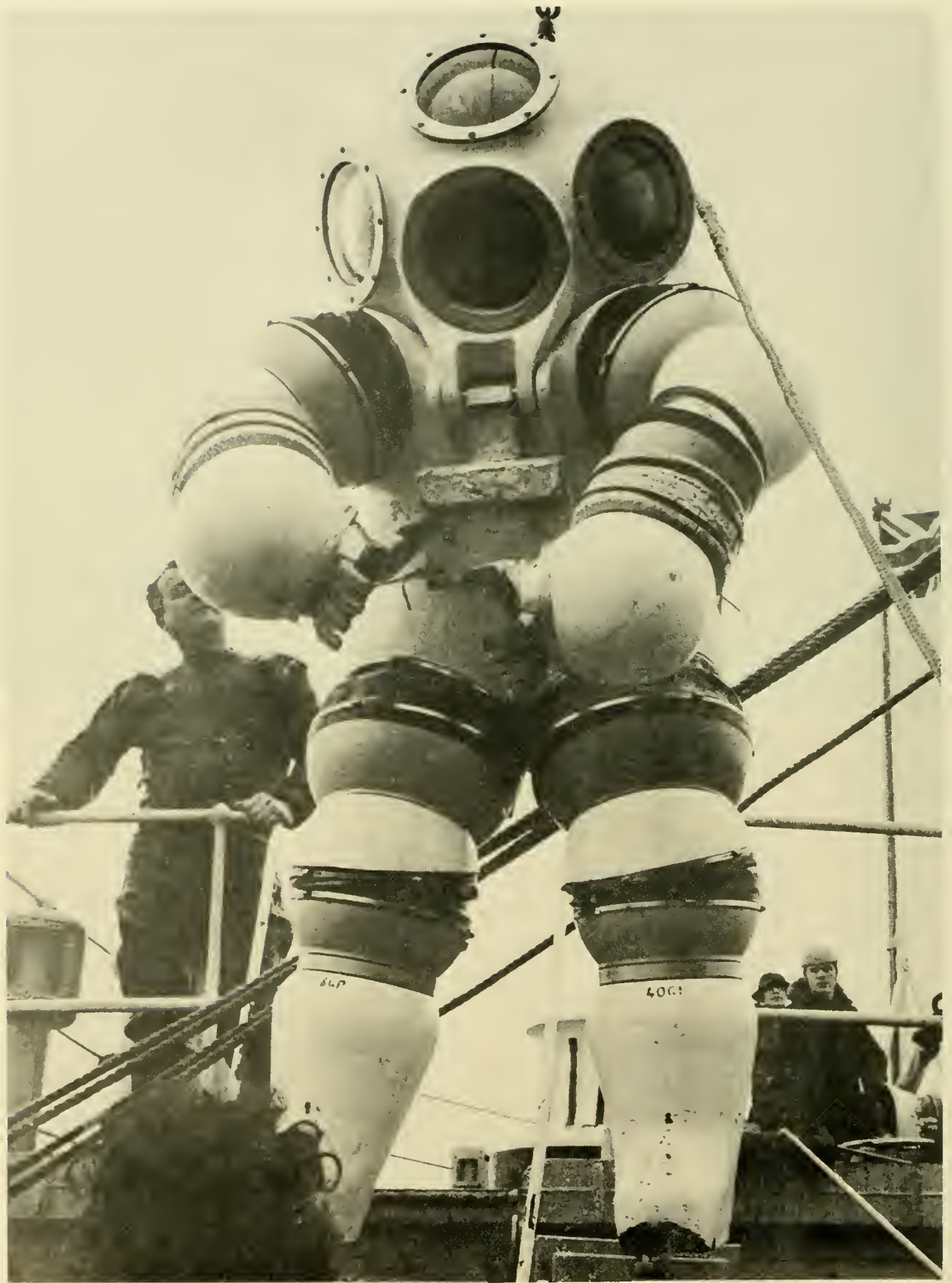

## JIM

LENGTH: .....  
BEAM: ..... 3.1 ft  
HEIGHT: ..... 6.5 ft  
DRAFT: .....  
WEIGHT (DRY): ..... 1,100 lb  
OPERATING DEPTH: ..... 1,300 ft  
COLLAPSE DEPTH: ..... NA  
LAUNCH DATE: ..... 1973

HATCH DIAMETER: ..... NA  
LIFE SUPPORT (MAX): ..... 16 man-hr  
TOTAL POWER: ..... Manual  
SPEED (KNOTS): CRUISE ..... NA  
MAX ..... NA  
CREW: PILOTS ..... 1  
OBSERVERS ..... 0  
PAYLOAD ..... NA

**PRESSURE HULL:** Main body and dome, knee spacer and boots are composed of magnesium alloy RZ5. All joints are composed of aluminum alloy forgings, as are the elbow spacers and hand enclosures.

**BALLAST/BUOYANCY:** Lead ballast of approximately 150 lb is required to reach neutral buoyancy. Additional buoyancy of 15 to 50 lb (depending upon bottom conditions) is required for negative buoyancy. This ballast is jettisonable. For independent mobility the lifting cable can be jettisoned. By dropping all ballast the operator will ascend at a rate of about 100 fpm.

**PROPULSION/CONTROL:** A lift cable provides ascent/descent. Mobility on the sea floor is by walking.

**TRIM:** No systems provided.

**POWER SOURCE:** Manual.

**LIFE SUPPORT:** Sufficient O<sub>2</sub> is carried externally in two flasks (440 l at 150 atm. each) and provides 4 hr for working with a 12-hr reserve. The operator wears an oronasal mask with an inhale and exhale tube, both are connected to CO<sub>2</sub> scrubbers (soda lime) and work at atmospheric pressure. Two complete O<sub>2</sub> and CO<sub>2</sub> sets are provided, one for backup. Monitoring instruments in the suit are for O<sub>2</sub> internal pressure, temperature. Lightweight clothing can be worn and in the waters where JIM has worked (Scotland) the internal temperature has stabilized at 19 to 20°C.

**VIEWING:** Four viewports in the dome and two at the back. The viewports are concave-convex lenses machined from Plexiglas 222.

**OPERATING/SCIENTIFIC EQUIPMENT:** Compass.

**MANIPULATORS:** Initially four simulated fingers were used and operated on a 1-to-1 mechanical linkage with a thumb on a swivel base, though satisfactory, other alternatives to these general purpose manipulators are being sought.

**SAFETY FEATURES:** Lift cable can be released if snarled. Ballast jettisonable. Two life support systems.

**SURFACE SUPPORT:** SDD.

**OWNER:** DHB Construction Ltd., England.

**BUILDER:** Underwater Marine Equipment Ltd., Farnborough, Hants, England.

**REMARKS:** Developmental stage in August 1973 at which time it had dived to 442 ft. Classification to 1,300 ft operating depth was under contemplation by Lloyds Register of Shipping. JIM's design and operation fulfill every definition of a manned submersible (chap. 1).

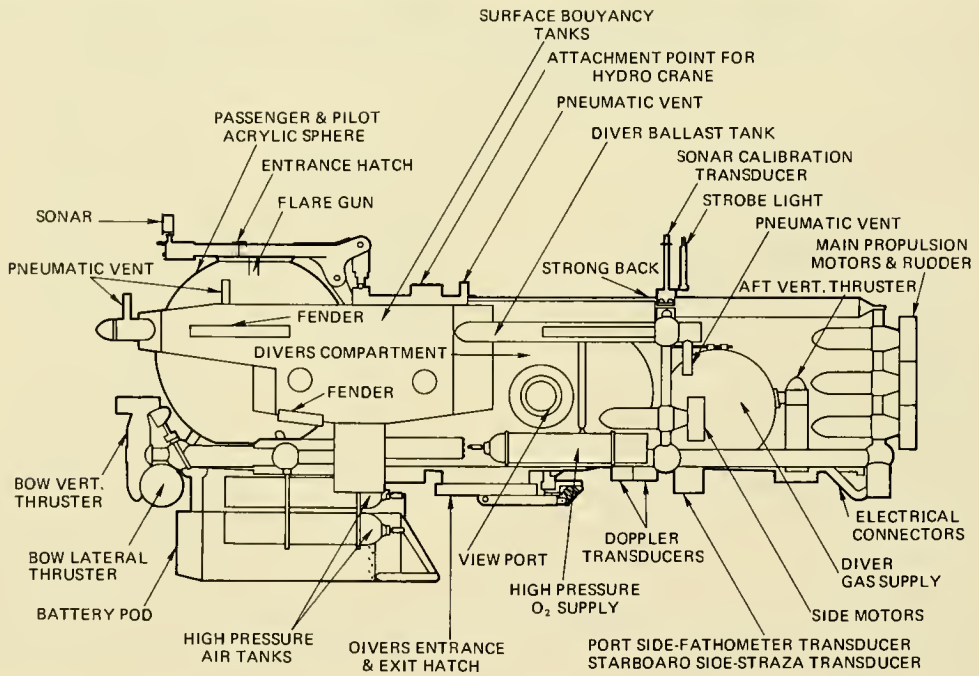
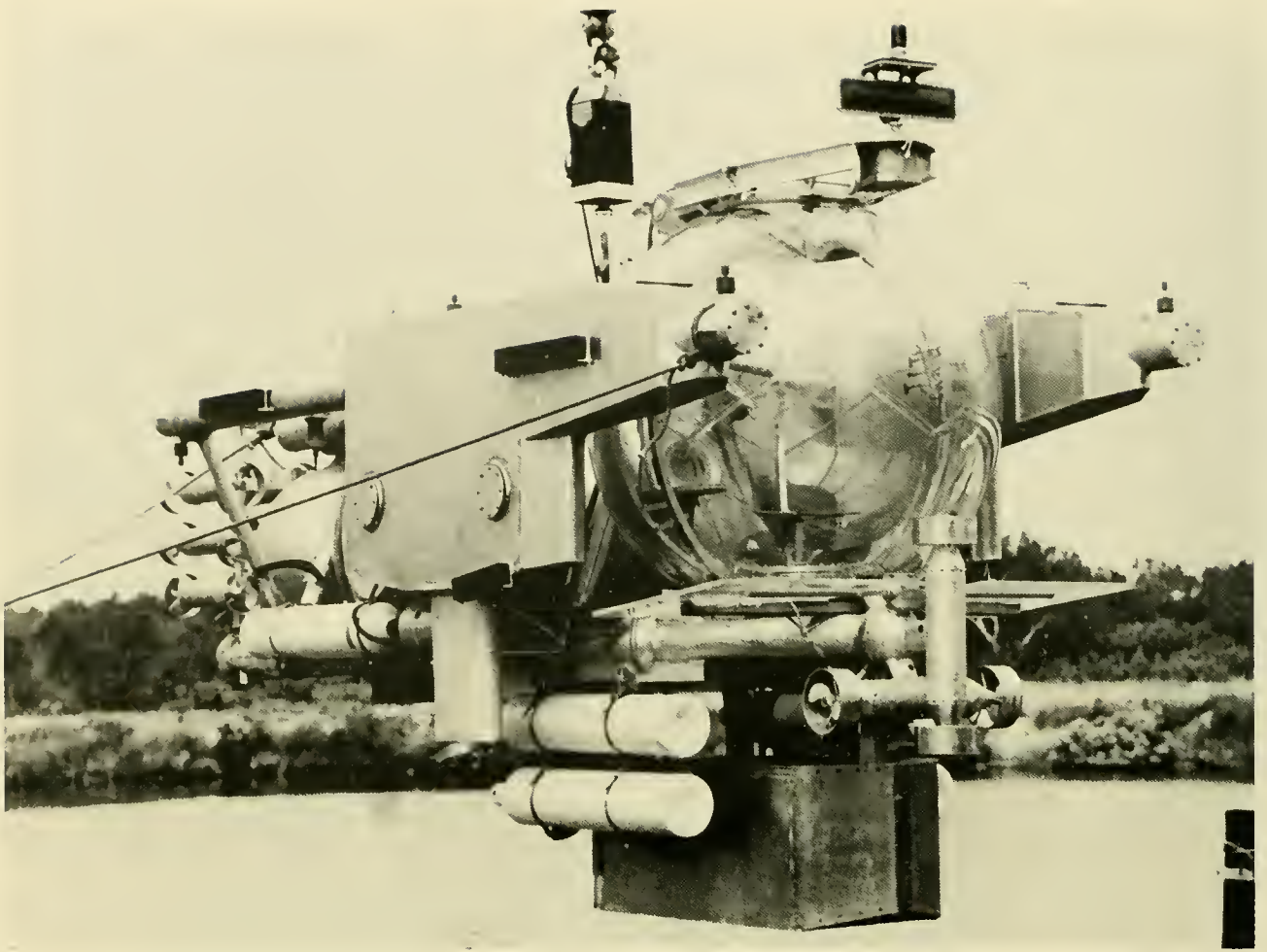



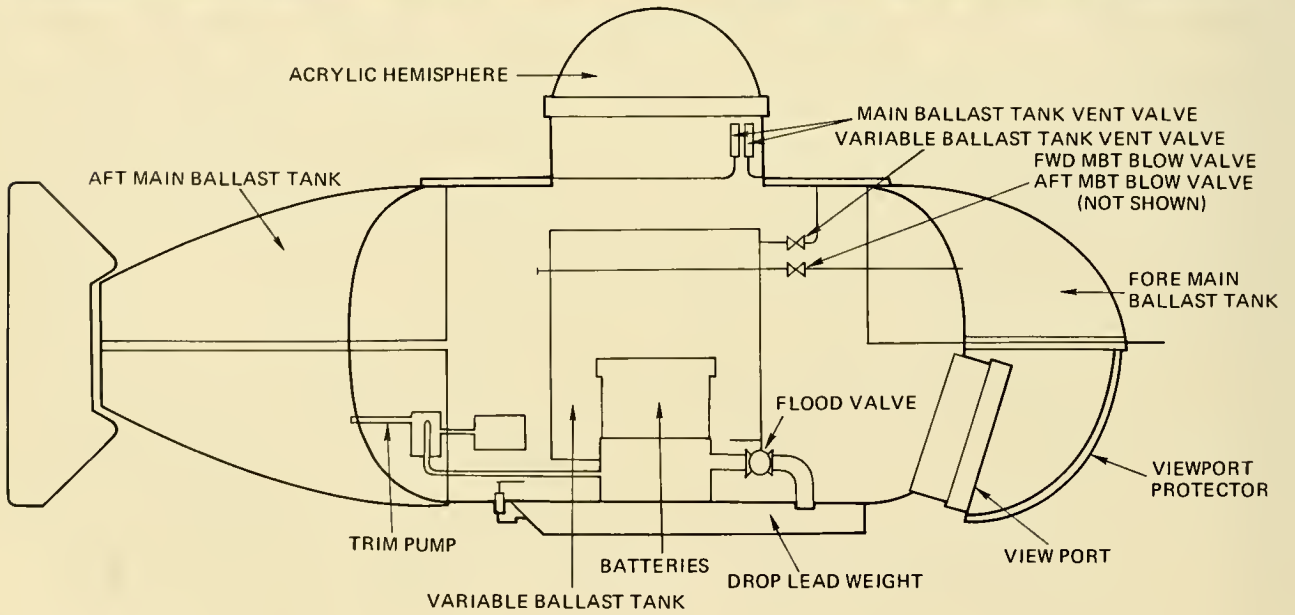
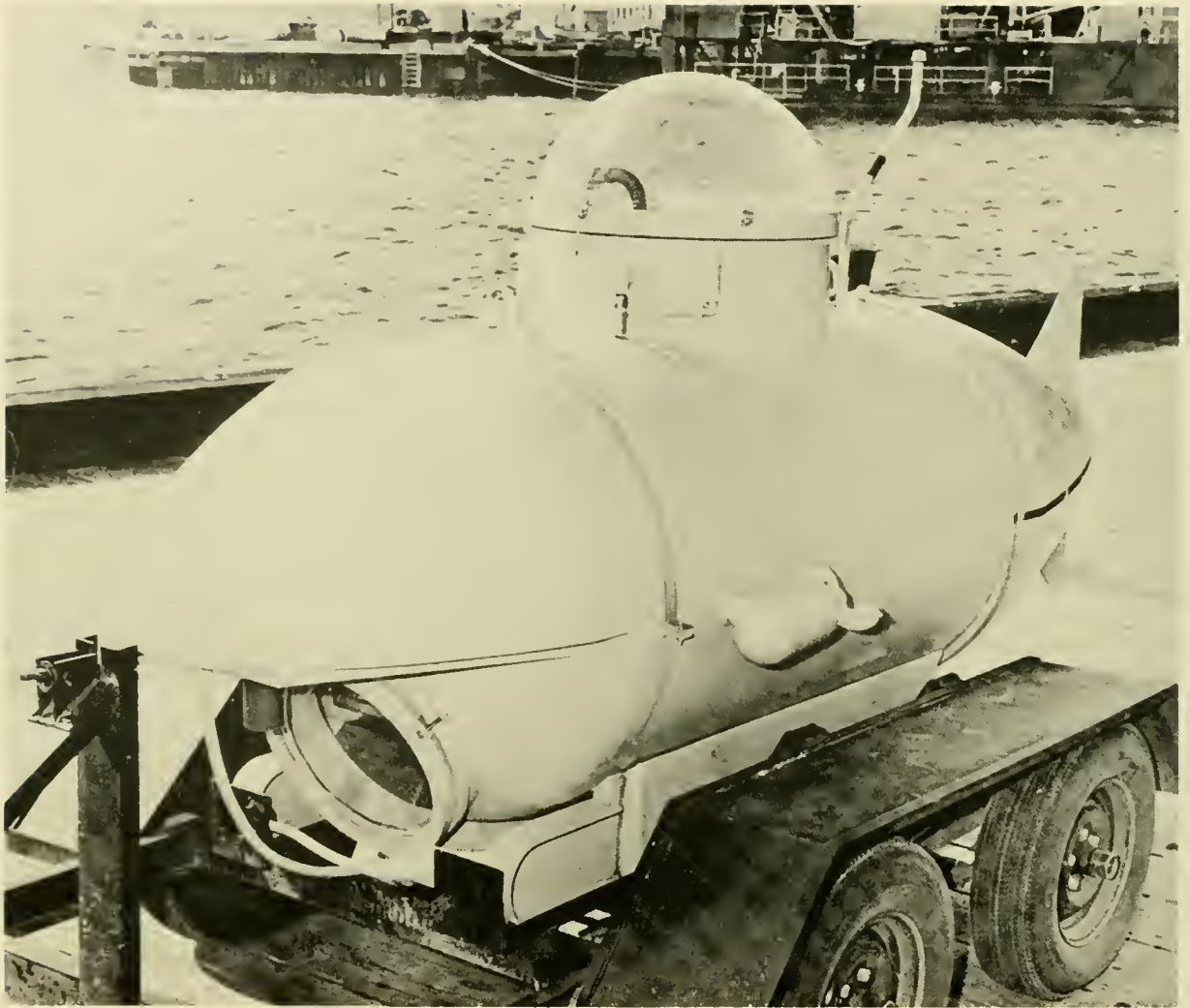



K-250

LENGTH: ..... 10.5 ft  
BEAM: ..... 4.7 ft  
HEIGHT: ..... 5 ft  
DRAFT: ..... 3 ft  
WEIGHT (DRY) ..... 2,200 lb  
OPERATING DEPTH: ..... 250 ft  
COLLAPSE DEPTH: ..... NA  
LAUNCH OATE: ..... ca. 1966

HATCH DIAMETER: ..... 22 in.  
LIFE SUPPORT (MAX): ..... 6 man-hr  
TOTAL POWER: ..... NA  
SPEED (KNOTS): CRUISE ..... NA  
                  MAX ..... 2.5  
CREW: PILOTS ..... 1  
      OBSERVERS ..... 0  
PAYLOAD: ..... 280 lb

**PRESSURE HULL:** Cylindrical shape composed of 0.25-in-thick gage steel with internal "T" bar frames.

**BALLAST/BUOYANCY:** Two fiberglass main ballast tanks, free-flooding and blown by compressed air. A variable ballast tank within the hull provides buoyancy changes when submerged. The VBT is normally pumped dry, but can be blown dry if necessary.

**PROPULSION/CONTROL:** Two motors (port/starboard) are rotatable 360° in the vertical. The motors have three speeds forward and are manually rotated. A rudder provides underway directional control.

**TRIM:** No system provided.

**POWER SOURCE:** Four 12-V, lead-acid batteries carried within the hull.

**LIFE SUPPORT:** Relies upon air entrapped in hull when hatch is closed. Snorkel for surface operations.

**VIEWING:** Plastic dome (24-in. diam.) on conning tower provides 360° of viewing. Viewport in bow 2 in. thick, 16-in. diam.

**OPERATING/SCIENTIFIC EQUIPMENT:** UQC, depth gage.

**MANIPULATORS:** None.

**SAFETY FEATURES:** Droppable weight (190 lb), MBT's and VBT can be blown dry at operational depth. Pressure hull can be flooded for emergency egress.

**SURFACE SUPPORT:** SOO.

**OWNER:** Various.

**BUILDER:** G.W. Kittredge, Warren, Maine.

**REMARKS:** Six of these vehicles were completed by 1971 and six more were under construction at that time. Also designated as the VAST MK III.

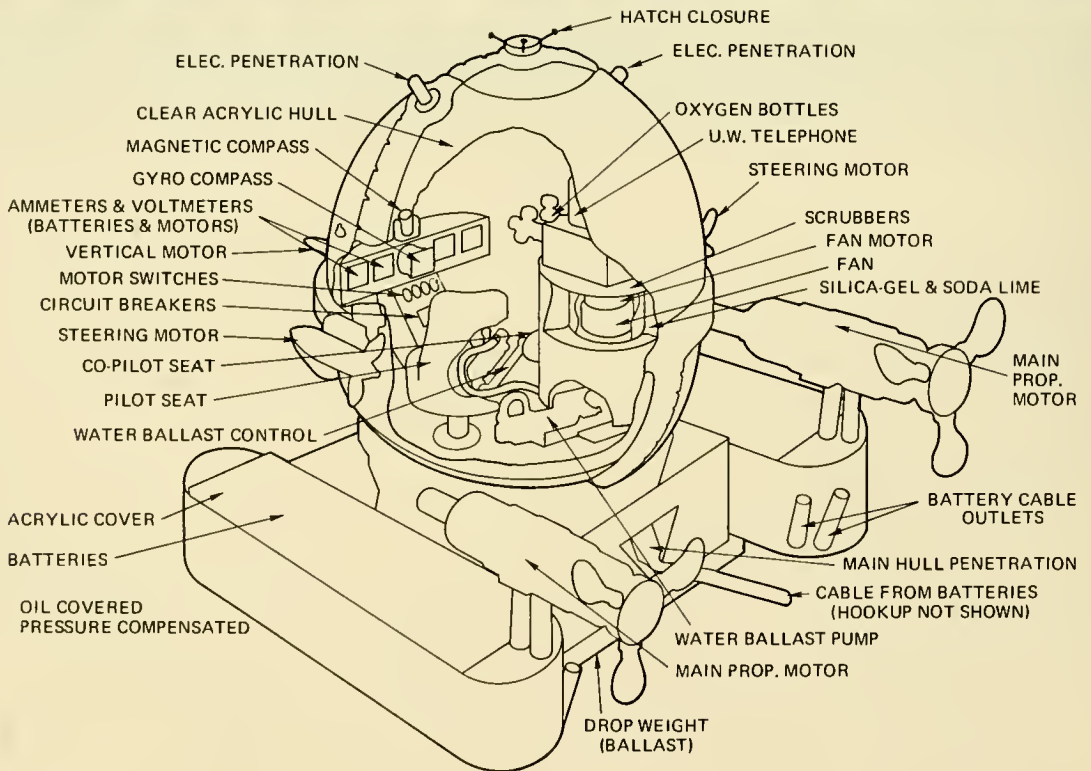

## KUMUKAHI

LENGTH: ..... 5.9 ft  
BEAM ..... 6.6 ft  
HEIGHT: ..... 7.5 ft  
DRAFT: ..... 7.5 ft  
WEIGHT (DRY): ..... 3,700 lb  
OPERATING DEPTH: ..... 300 ft  
COLLAPSE DEPTH: ..... 1,000 ft  
LAUNCH DATE: ..... 1969

HATCH DIAMETER: ..... 18 in.  
LIFE SUPPORT (MAX): ..... 32 man-hr  
TOTAL POWER: ..... 5.1 kWh  
SPEED (KNOTS): CRUISE ..... 1/4 hr  
MAX ..... 1.3/3 hr  
CREW: PILOTS ..... 1  
OBSERVERS ..... 1  
PAYLOAD: ..... 600 lb

**PRESSURE HULL:** Sphere of Rohm and Haas Plexiglas G, 1<sup>1</sup>/<sub>8</sub> in. thick, made in four parts and hot-press molded. Quarter parts bonded into a sphere using epoxy resin. Hull buoyancy 3,045 lb, weight in air 690 lb.

**BALLAST/BUOYANCY:** A 150-psi pump moves water into or out of a 15-gal tank within the hull to provide 93 lb of  $\pm$  buoyancy.

**PROPULSION/CONTROL:** Four fixed, reversible, 1/3-hp motors; 12-VOC Sears & Roebuck outboard trolling motors with minor modifications for kerosene-filled pressure-compensation and mounting. Two motors are mounted at the sides of the sphere for fore and aft motion. One motor is mounted at the top facing athwartships for transverse motion, another is mounted at the bow facing up for vertical motion.

**TRIM:** None.

**POWER SOURCE:** Two 18-VDC pods, each with three batteries (lead-acid) of fast drain type. Batteries are ESB Ltd 9, 143 amp-hr/6 hr built for golf cart use. Batteries are submerged in oil (SAE 30 motor oil) and pressure-compensated by a seawater bellows.

**LIFE SUPPORT:** Two Scott Aviation O<sub>2</sub> cylinders and two CO<sub>2</sub> humidity scrubbers contain soda lime and silica gel (2 men, 8 hours, 0.5% CO<sub>2</sub>, 60% rel. hum.). Instruments to check internal atmosphere are: Teledyne model 330 O<sub>2</sub> meter, MSA CO<sub>2</sub> tester, Taylor temperature/humidity gage, Taylor 2-psi differential pressure gage.

**VIEWING:** Panoramic viewing through plastic hull.

**OPERATING/SCIENTIFIC EQUIPMENT:** UQC (27-kHz), Directional gyrocompass and magnetic compass, depth gage.

**MANIPULATORS:** None.

**SAFETY FEATURES:** A 440-lb steel drop weight is located under the pods and is actuated by three turns of the thru-hull bolt. Pods and mount frame release with seven more turns of the same bolt. Flood valve can equalize internal pressure in 1.5 min for blow and go ascent to surface.

**SURFACE/SUPPORT:** SOO.

**OWNER:** Oceanic Foundation, Makapuu Point, Waimanalo, Hawaii.

**RUILDER:** Oceanic Institute, Makapuu Point, Waimanalo, Hawaii.

**REMARKS:** On display at Sea Life Park, Waimanalo, Hawaii.

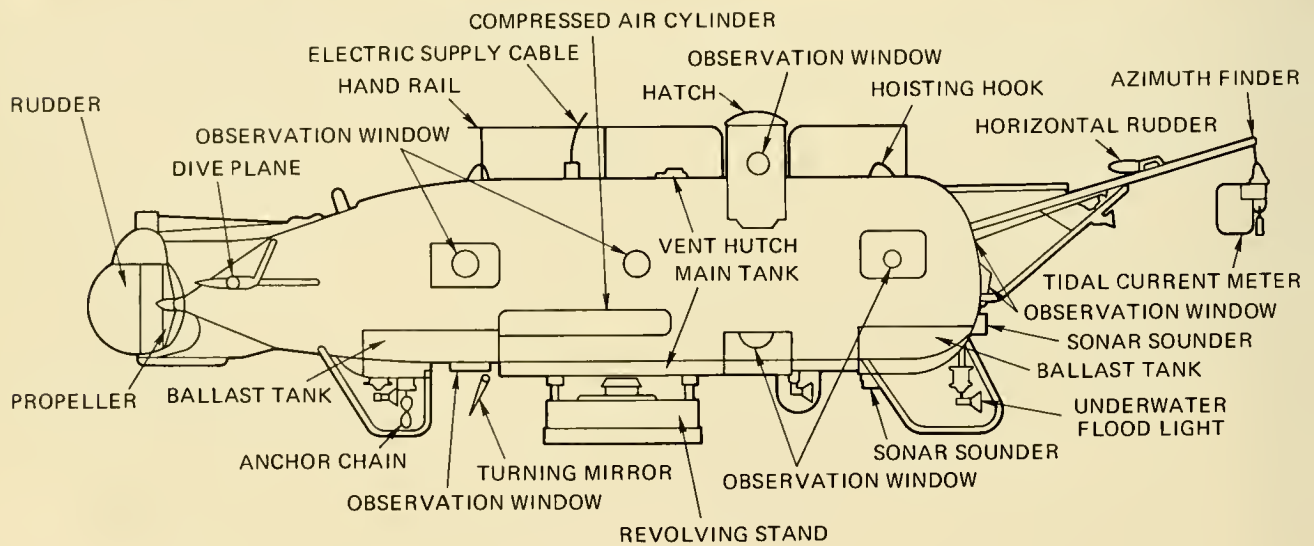
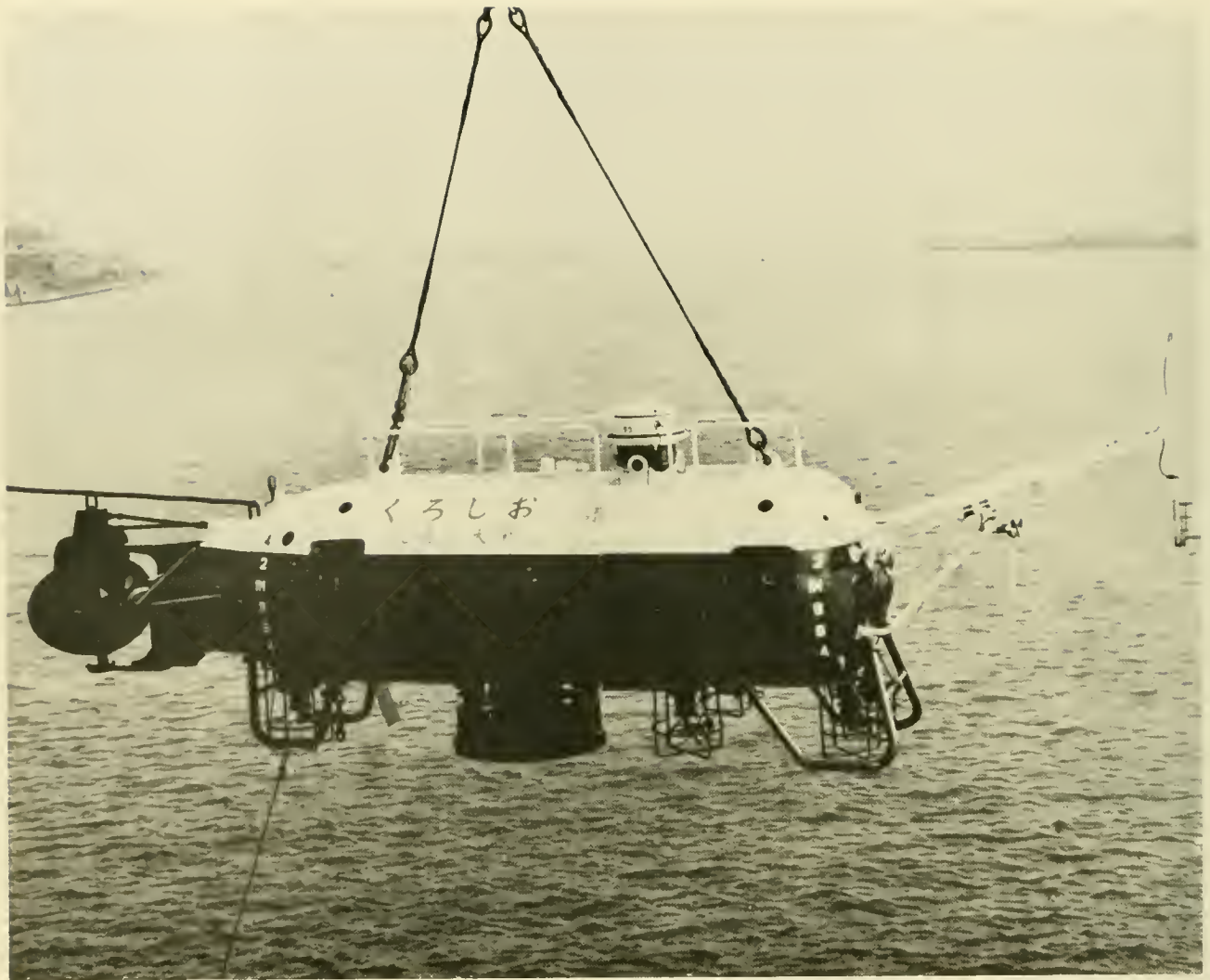

## KUROSHIO II

LENGTH: ..... 11.8 m  
BEAM: ..... 2.2 m  
HEIGHT: ..... 3.2 m  
DRAFT: ..... 1.9 m  
WEIGHT (DRY) ..... 12.5 tons  
OPERATING DEPTH: ..... 200 m  
COLLAPSE DEPTH: ..... 365 m  
LAUNCH DATE: ..... 1960

HATCH DIAMETER: ..... 538 mm  
LIFE SUPPORT (MAX): ..... 96 man-hr  
TOTAL POWER: ..... tethered  
SPEED (KNDTS): CRUISE ..... 1  
                                  MAX ..... 2  
CREW: PILOTS ..... 2  
          OBSERVERS ..... 2  
PAYLOAD: ..... NA

**PRESSURE HULL:** The main section of the hull is a cylinder of soft steel (SM41) 14 mm thick; 1,482-mm OD and 5,600-mm length. One end plate is a hemisphere of soft steel 24 mm thick and 1,300-mm radius. The other end plate is a cone of soft steel. The hatch coaming is a cylinder of soft steel 12 mm thick, 550-mm OD and 1,000 mm high. All components are joined by electrical welding.

**BALLAST/BUOYANCY:** Two ballast tanks fore (240 l) and aft (180 l) within pressure hull are flooded and pumped dry of seawater to obtain desired surface weight. A main tank (6,000 l) below the pressure hull is filled with seawater to capacity to obtain negative diving buoyancy. To ascend the ballast tanks are pumped dry and, upon reaching the surface, a low-pressure air hose from the support ship is used to blow the main tank.

**PROPULSION/CONTROL** A stern-mounted, three-bladed, 800-mm diam. propeller provides lateral propulsion and is driven by a 3.2-kW, three-phase AC, 4006 motor. Underway lateral control is through two rudders mounted within a cylinder surrounding the propeller which is trained left/right. Two stern-mounted, port-starboard bow planes control vertical movement.

**TRIM:** Up/down bow angles can be obtained by differential filling of the VBT's.

**POWER SOURCE:** A 600 m long, 36-mm diam. cable from surface ship supplies all electrical power.

**LIFE SUPPORT:** Compressed O<sub>2</sub> is carried in a 40-l-capacity cylinder. CO<sub>2</sub> removal is through a 100-W ventilation system.

**VIEWING:** Sixteen viewports throughout the vehicle ranging in diameter from six 60-mm, seven 120-mm to three 160-mm.

**OPERATING/SCIENTIFIC EQUIPMENT:** Hard-wired telephone to support ship (24-V, battery-powered), battery (3-V) powered compass, tidal current meter, water temperature sensor, horizontal vertical sonars.

**MANIPULATORS:** None.

**SAFETY FEATURES:** Main ballast tanks can be blown. Electric supply cable can be manually detached from within the pressure hull. Vehicle can be hoisted to surface by power cable. Marker buoy.

**SURFACE/SHORE SUPPORT:** Towed by support ship to and from dive site.

**OWNER:** University of Hokkaido, Hokkaido, Japan.

**BUILDER:** Japanese Steel and Tube Co., Hokkaido, Japan.

**REMARKS:** Operational. Kuroshio I was a tethered vehicle also, and operated from 1951 through 1960. Kuroshio II radically departs from its predecessor's design, in that Kuroshio I was basically a diving bell configured for support from the surface.

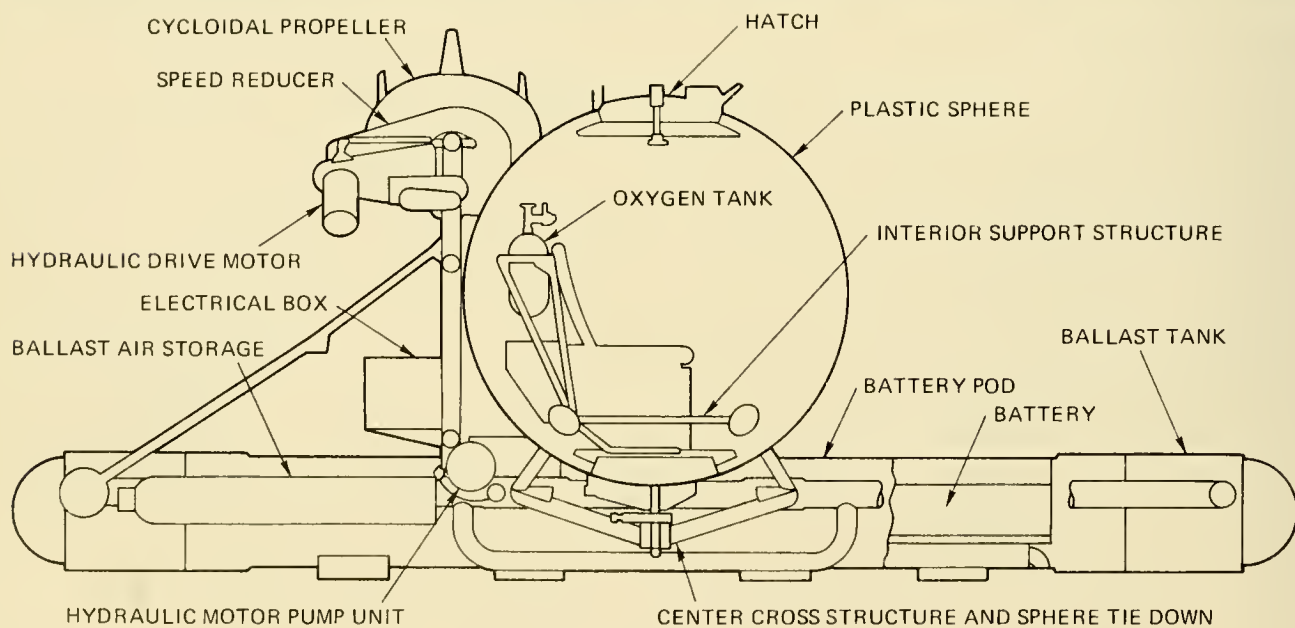
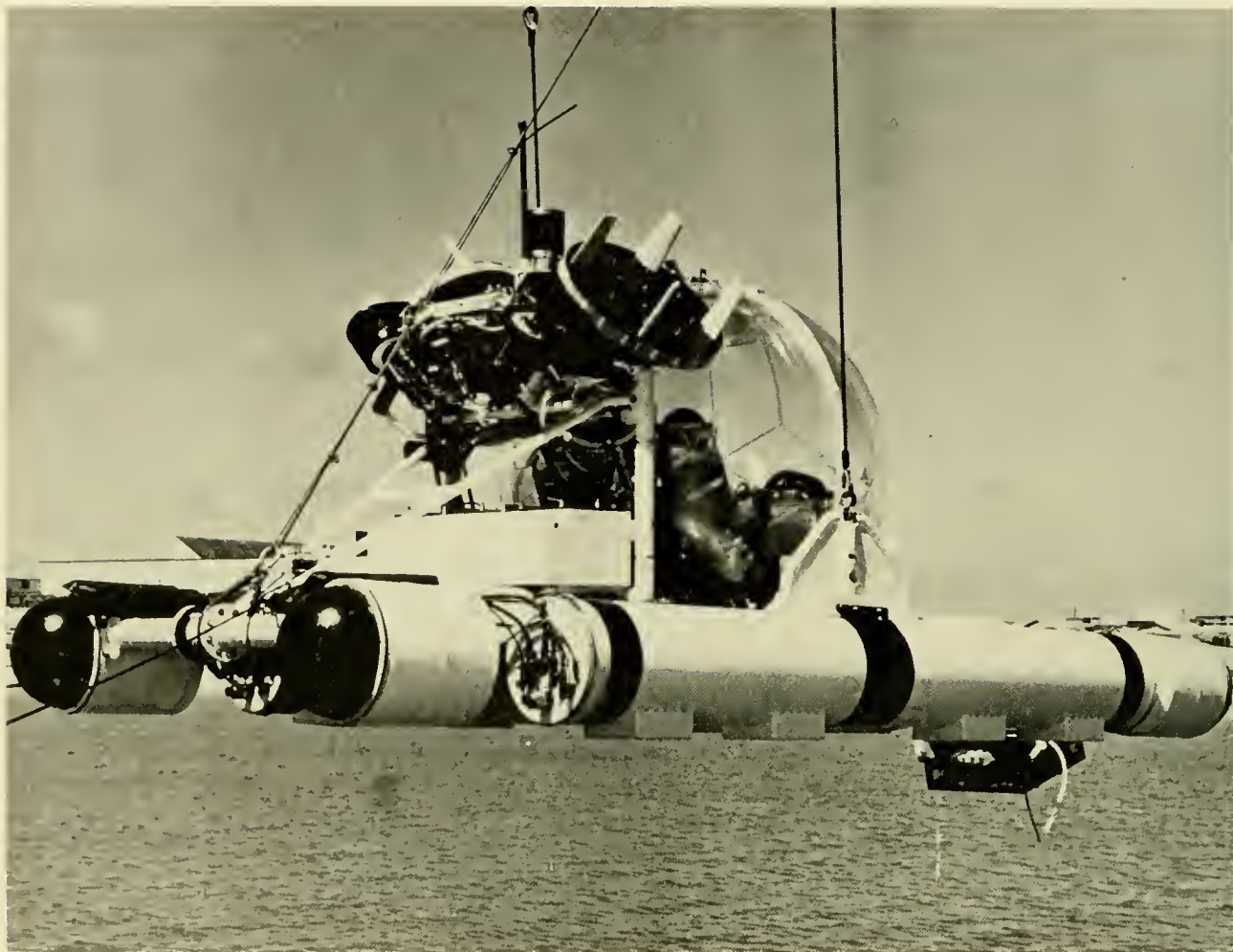

## MAKAKAI

LENGTH: ..... 18.5 ft  
BEAM: ..... 8 ft  
HEIGHT: ..... 7.5 ft  
DRAFT: ..... 5.9 ft  
WEIGHT (DRY): ..... 5.3 tons  
OPERATING DEPTH: ..... 600 ft  
COLLAPSE DEPTH: ..... 4,150 ft  
LAUNCH DATE: ..... 1974

HATCH DIAMETER: ..... 18.5 in.  
LIFE SUPPORT (MAX): ..... 72 man-hr  
TOTAL POWER: ..... 36 kWh  
SPEED (KNOTS): CRUISE ..... 0.75/8 hr  
MAX ..... 3  
CREW: PILOTS ..... 1  
OBSERVERS ..... 1  
PAYLOAD: ..... 870 lb

**PRESSURE HULL:** Acrylic plastic (Plexiglas G) sphere composed of 12 spherical pentagons bonded together with adhesive. Hull is 66-in. OD and 2.5 in. thick. Top (hatch) and bottom plates are of cadmium plated 4130 steel. Bottom plate is for passage of penetrators. Hull weighs 1,500 lb in air and displaces 5,500 lb in water. A 0.5-in-thick acrylic cap around the pressure hull protects it from abrasion or accidental impact.

**BALLAST/BUOYANCY:** Variable weight system consisting of four pressure-compensated ballast tanks mounted at each corner of the vehicle from which water may be pumped into or out. System is limited to three complete fill/refill cycles by the volume of compressed air used for pressure compensation, 400 lb may be gained or lost.

**PROPULSION/CONTROL:** Two Kirsten Boeing, pi-pitch cycloidal propellers provide four degrees of maneuvering freedom and are driven by a 4-hp hydraulic motor.

**TRIM:** Gross trim is adjusted manually before diving by fore or aft movement of 1,200-lb (each) battery pods. Trim is controlled up or down by pumping water fore or aft in the ballast tanks. Roll is controlled by pumping water overboard on one side and taking water onboard on the other.

**POWER SOURCE:** External, pressure-compensated, lead-acid batteries in two pods, each containing a 120-V and 30-V battery string. The 120-V string is made up of twenty 6-V, 190-amp-hr batteries which power the propulsion and ballast systems and lights. The 30-V string powers the controls, electronics and scientific instrument payload.

**LIFE SUPPORT:** O<sub>2</sub> is stored in the pressure hull in high pressure flasks and is bled through a pressure reducer at 2 ft<sup>3</sup>/hr. CO<sub>2</sub> is removed by Baralyme and water vapor by silica gel. Both O<sub>2</sub> and CO<sub>2</sub> are monitored visually from instruments within the sphere. Three blowers circulate the air to remove water vapor and CO<sub>2</sub>.

**VIEWING:** Panoramic viewing is provided through plastic pressure hull.

**OPERATING/SCIENTIFIC EQUIPMENT:** UQC (8.08-kHz), two depth gages, altimeter.

**MANIPULATORS:** None.

**SAFETY FEATURES:** Emergency breathing through two closed-circuit O<sub>2</sub> rebreathers of 36-hr capacity each. Pressure hull mechanically releasable from chassis. Jettisonable 50-lb ballast weight. Jettisonable 1,200-lb battery pods (2,400 lb total). Additional surface freeboard (3 ft total) may be obtained by inflation of four modules (one at each corner of the chassis).

**SURFACE SUPPORT:** Air, ship, or truck/trailer transportable. May be launched/retrieved from conventional ship with necessary capacity handling system. Has been deployed and retrieved with LARP system (see chap. 12).

**OWNER:** U.S. Naval Undersea Center, San Diego, Calif.

**BUILDER:** USNUC, Kaneohe Bay, Hawaii.

**REMARKS:** Placed in storage in 1974.

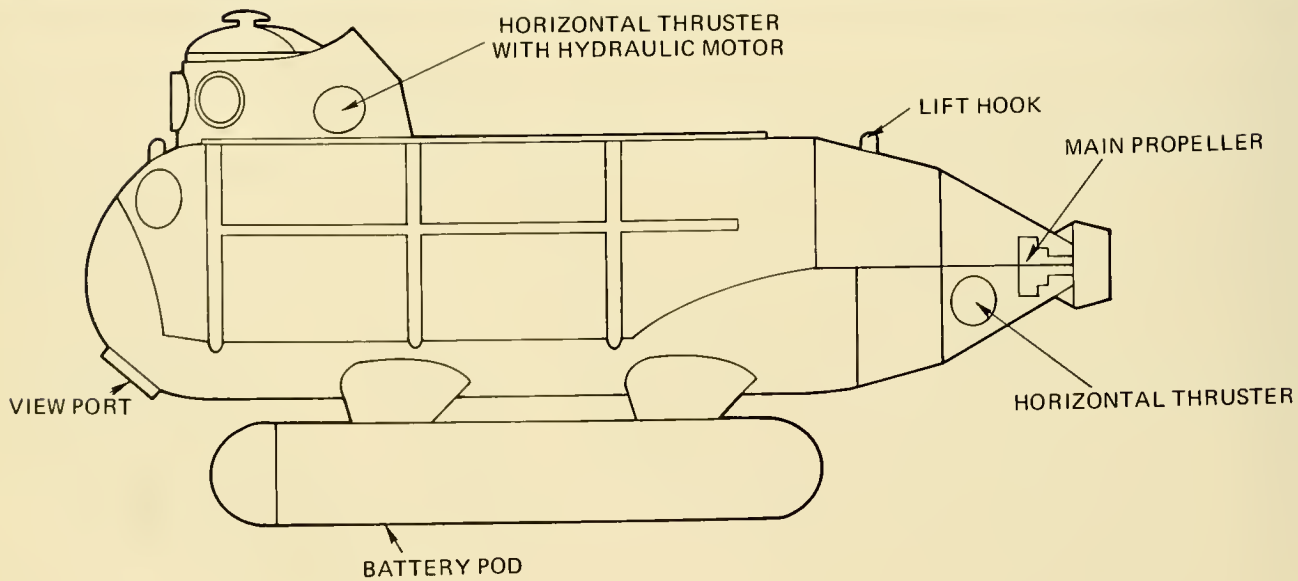
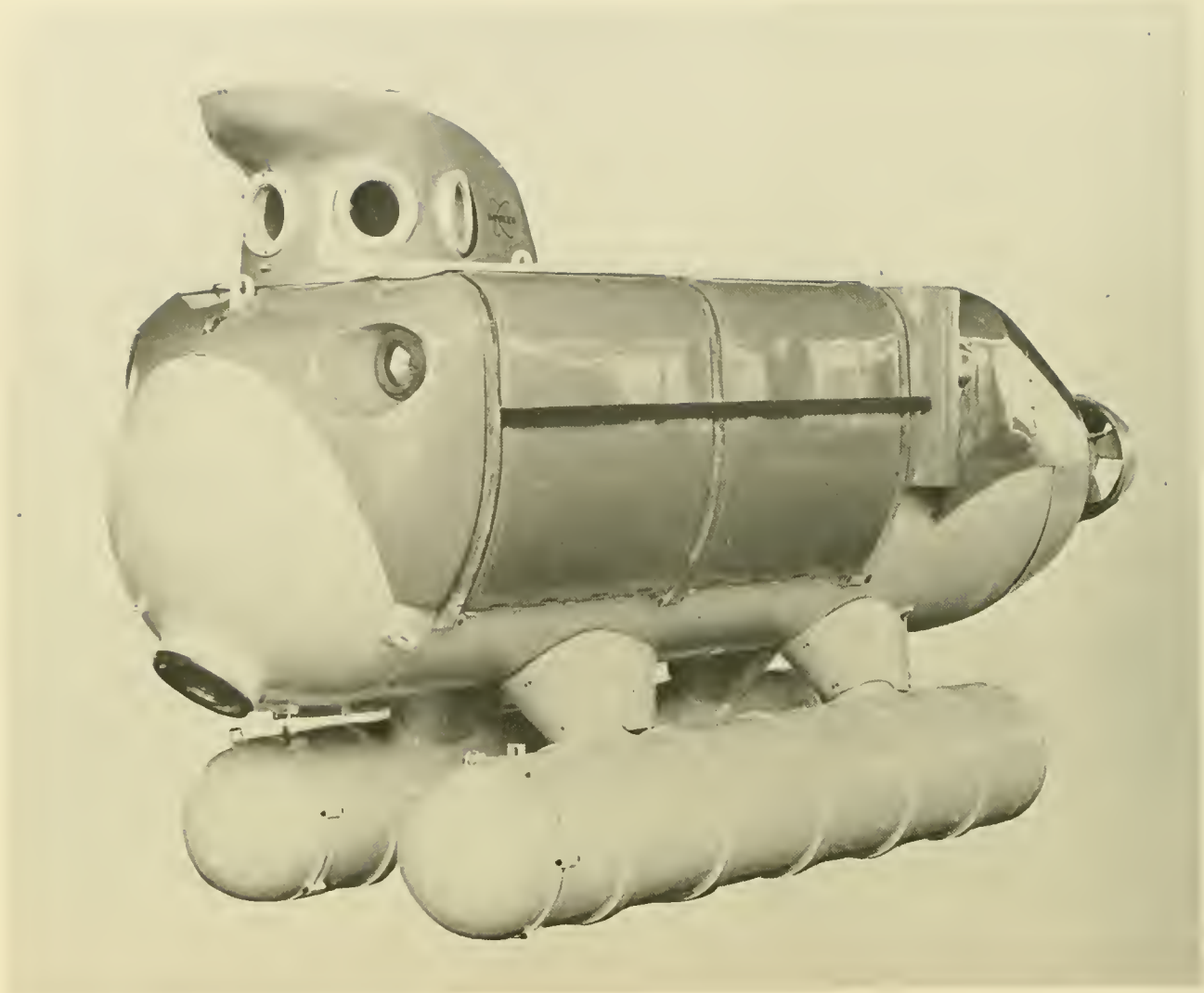



## MERMAID I/II

LENGTH: ..... 5.15 m  
BEAM: ..... 1.70 m  
HEIGHT: ..... 2.60 m  
DRAFT: ..... 1.8 m  
WEIGHT (DRY): ..... 6.3 tons  
OPERATING DEPTH: ..... 300 m  
COLLAPSE DEPTH: ..... 600 m  
LAUNCH DATE: ..... 1972

HATCH DIAMETER: ..... 0.60 m  
LIFE SUPPORT (MAX): ..... 120 man-hr  
TOTAL POWER: ..... 16.2 kWh  
SPEED (KNOTS): CRUISE ..... 1.5/8 hr  
                  MAX ..... 3/4 hr  
CREW: PILOTS ..... 1  
      OBSERVERS ..... 1  
PAYLOAD: ..... 550 kg

**PRESSURE HULL:** Cylindrical shape composed of three cylindrical sections and two endcaps of high tensile steel (St 53.7). Diameter of the cylinder is 1.25 m; thickness is 15 mm and total length is 4.30 m. A cylindrical conning tower (600-mm diam.) is welded to the main hull.

**BALLAST/BUOYANCY:** Glass-fiber reinforced ballast tanks (300 kg total) are located one on each side and atop the pressure hull. The tanks are free-flooding for descent and blown dry for ascent by compressed air. Fine buoyancy adjustments are made by regulating tanks in the pressure hull which are blown by compressed air.

**PROPULSION/CONTROL:** A stern-mounted propeller driven by a 3-hp motor provides fore and aft propulsion. Two lateral thrusters, one in the stern and one aft of the conning tower, are each driven by a 1.6-hp motor. All propellers are controlled independently and are reversible which allows any combination of lateral thrust.

**TRIM:** Within the "legs" beneath the vehicle is a trim system which is hydraulically or manually operated and can obtain up/down bow angles of  $\pm 20^\circ$  by moving the batteries fore or aft.

**POWER SOURCE:** Within the two "legs" are pressure-resistant containers holding two lead-acid accumulators which supply 660 amp-hr at 24 V. An emergency battery of 24 V, 115 amp-hr is carried within the pressure hull.

**LIFE SUPPORT:** O<sub>2</sub> is supplied from tanks of 24-l capacity mounted external to the pressure hull. CO<sub>2</sub> is removed automatically on command by a special compound called Drager-Atem Kalk and a CO<sub>2</sub> detector controls removal rate.

**VIEWING:** Four viewports are available: three in the conning tower of 180-mm diameter and 35 mm thick and one in the bow of 22-mm diameter and 55 mm thick.

**OPERATING/SCIENTIFIC EQUIPMENT:** UQC, echo sounder, depth gage, directional gyrocompass.

**MANIPULATORS:** None.

**SAFETY FEATURES:** Mechanically droppable ballast. Ballast tanks may be blown at maximum operating depth by a hand valve or compressed air. A pressure sensor may be set to automatically activate surfacing if maximum depth is exceeded. Emergency battery in pressure hull; hull may be flooded for egress.

**SURFACE SUPPORT:** SOO.

**OWNER:** International Underwater Contractors, New York City.

**BUILDER:** Bruker-Physik A.G. Karlsruhe, West Germany.

**REMARKS:** Operational. A prototype, MERMAID I, was launched and tested in 1972. From these tests modifications were made and the vehicle renamed MERMAID I/II in 1973.

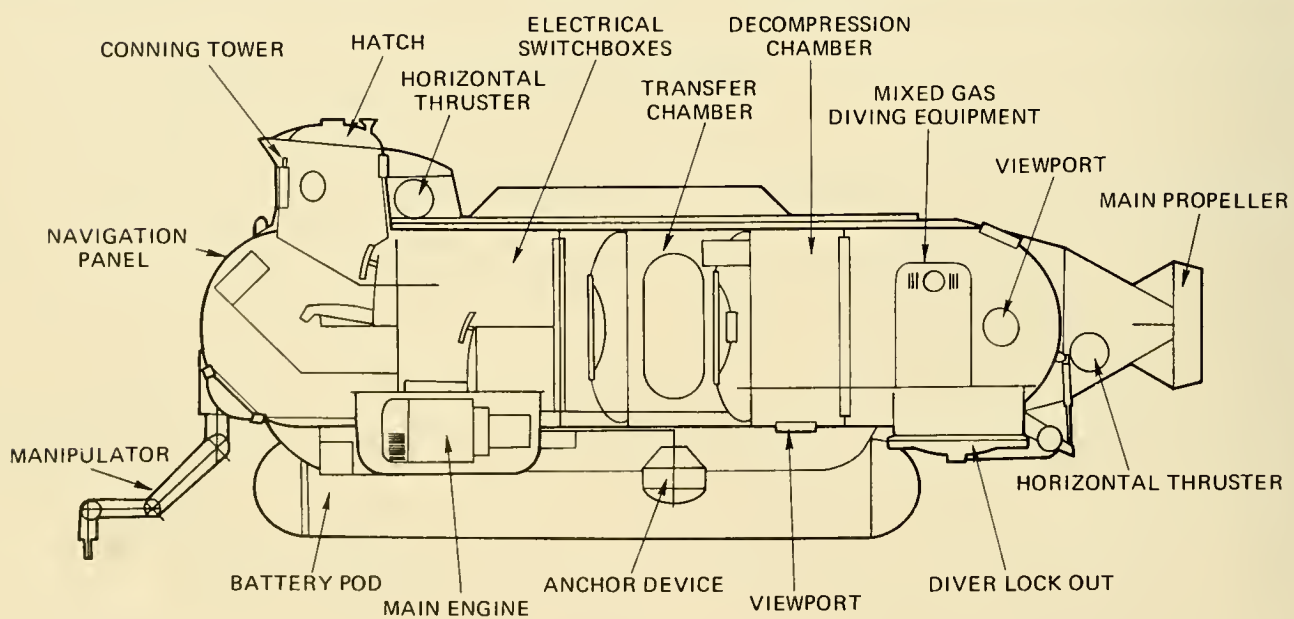
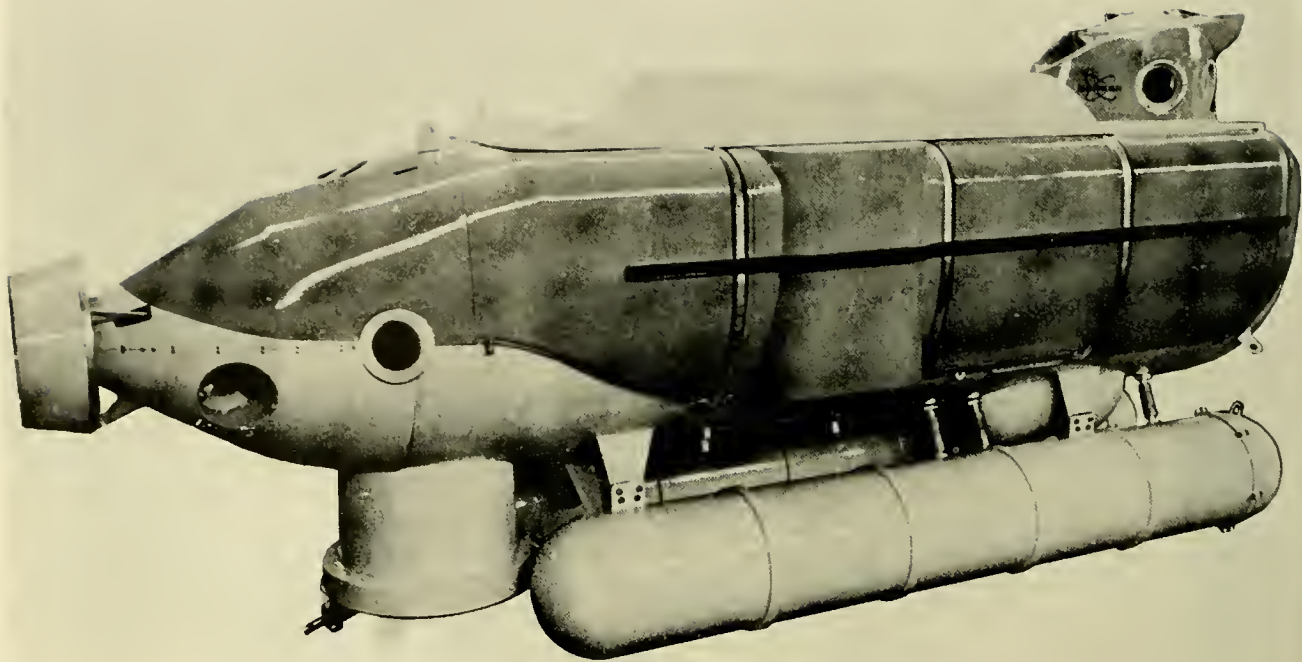

## MERMAID III/IV

LENGTH: ..... 6.2 m  
BEAM: ..... 1.8 m  
HEIGHT: ..... 2.7 m  
DRAFT: ..... NA  
WEIGHT (DRY): ..... 10.5 tons  
OPERATING DEPTH: ..... 200 m  
COLLAPSE DEPTH: ..... NA  
LAUNCH DATE: ..... 1975

HATCH DIAMETER: ..... main hull 0.6 m  
HATCH DIAMETER: ..... lock-out 0.7 m  
LIFE SUPPORT (MAX): ..... 120 man-hr  
TOTAL POWER: ..... 36 kWh  
SPEED (KNOTS): CRUISE ..... NA  
MAX ..... 2/1 hr  
CREW: PILOTS ..... 2  
OBSERVERS ..... 2  
PAYLOAD: ..... NA

**PRESSURE HULL:** Composed of two cylinders of high tensile steel (St 53.7) both with hemispherical endcaps and joined by a cylindrical chamber. The forward cylinder operates at atmospheric pressure; the after cylinder operates at ambient pressure and is equipped for diver lock-out.

**BALLAST/BUOYANCY:** NA.

**PROPULSION/CONTROL:** Main propulsion is from a 10-kW, stern-mounted hydraulically-actuated propeller continuously variable in speed and reversible. Two lateral thrusters of 1-kW each are mounted fore and aft, provisions can be made to also incorporate vertical thrusters.

**TRIM:** NA.

**POWER SOURCE:** Same as MERMAID I/II.

**LIFE SUPPORT:** Same as MERMAID I/II for the atmospheric (forward) cylinder. He/O<sub>2</sub> supply for the divers consists of four flasks of 50-l capacity (each).

**VIEWING:** Nine plastic viewports. Five in conning tower of 170-mm diam, and two of 80-mm diam. Four viewports in lock-out chamber of 70-mm diam. The bow can be fitted with two or three viewports or one large plastic hemisphere.

**OPERATING/SCIENTIFIC EQUIPMENT:** UOC, depth gage, echo sounder, compass.

**MANIPULATORS:** None.

**SAFETY FEATURES:** No data available, but is assumed equal to that of MERMAID I/II.

**SURFACE SUPPORT:** SOO.

**OWNER:** International Underwater Contractors, New York City.

**BUILDER:** Bruker-Physik A.G. Karlsruhe, West Germany.

**REMARKS:** These are two identical lock-out submersibles. MERMAID III/IV is scheduled to be operational by 1975.

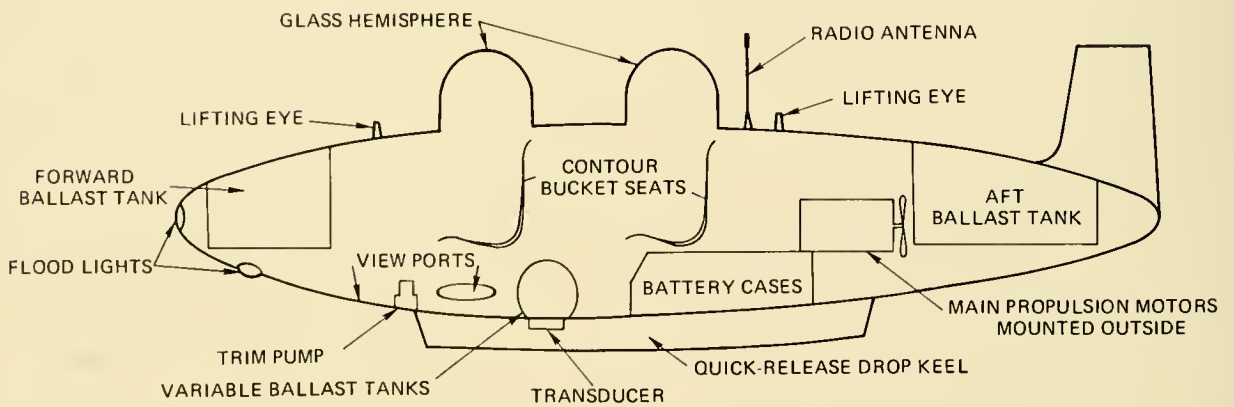
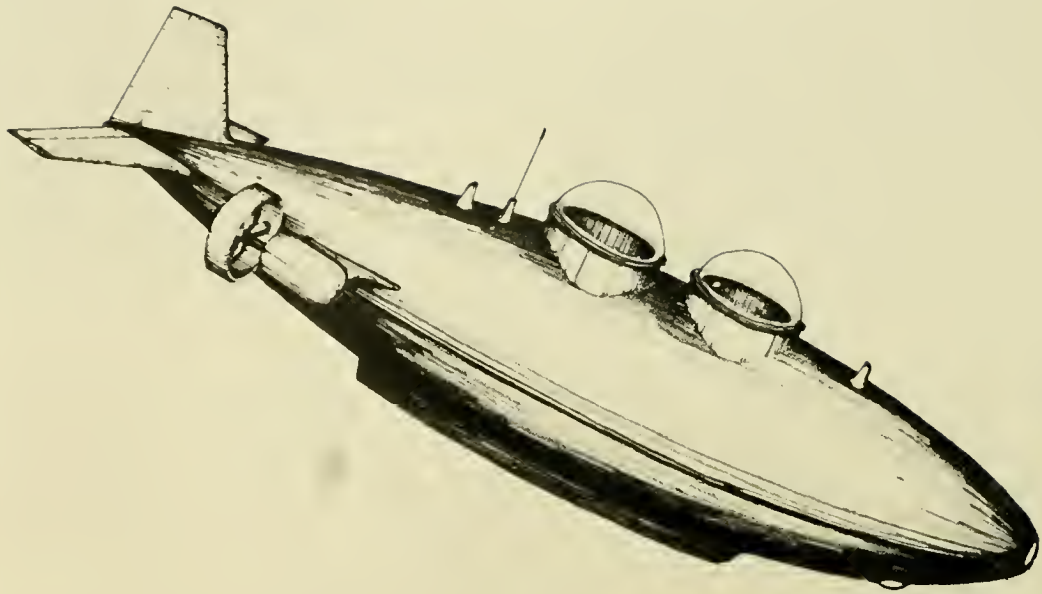

## MINI DIVER

LENGTH: ..... 16 ft  
BEAM: ..... 3.5 ft  
HEIGHT: ..... 5 ft  
DRAFT: ..... 2 ft  
WEIGHT (DRY): ..... 1.9 tons  
OPERATING DEPTH: ..... 250 ft  
COLLAPSE DEPTH: ..... 400 ft  
LAUNCH DATE: ..... 1968

HATCH DIAMETER ..... NA  
LIFE SUPPORT (MAX): ..... 18 man-hr  
TOTAL POWER: ..... NA  
SPEED (KNOTS): CRUISE ..... 1/6 hr  
                  MAX ..... 6  
CREW: PILOTS ..... 1  
      OBSERVERS ..... 1  
PAYLOAD: ..... 300 lb

**PRESSURE HULL:** Cylindrical shape of welded steel 0.275 in. thick, 3-ft OD. Penetrations include two for motors, dive planes, rudder and three for viewports.

**BALLAST/BUOYANCY:** Surface buoyancy derived from a main ballast tank; submerged buoyancy changes are obtained from a variable ballast tank.

**PROPULSION/CONTROL:** Lateral propulsion is obtained from two stern-mounted, 1-hp, 6-V propellers. Diving planes and a rudder provide underway maneuvering.

**TRIM:** No system provided.

**POWER SOURCE:** All power is derived from four 6-V lead-acid batteries.

**LIFE SUPPORT:** Compressed air for O<sub>2</sub>; CO<sub>2</sub> absorbant.

**VIEWING:** Three, 16-in. diam. acrylic plastic viewports.

**OPERATING/SCIENTIFIC EQUIPMENT:** Transponder, Fathometer, artificial horizon, chronometer, compass, UQC.

**MANIPULATORS:** None.

**SAFETY FEATURES:** Droppable ballast, emergency breathing apparatus for escape

**SURFACE/ShORE SUPPORT:** SOO.

**OWNER:** Great Lakes Underwater Sports, Inc., Elmwood Park, Ill.

**BUILDER:** Same as above.

**REMARKS:** Not operating. Deepest dive 70 ft. Undergoing refit, operational future depends on market for vehicle or services.



## NAUTILETTE

LENGTH: .....	1-man: 11.25 ft	HATCH DIAMETER: .....	22 in.
	2-man: 13.75 ft	LIFE SUPPDRT (MAX): .....	1;2 man-hr
BEAM: .....	4.5 ft	TOTAL POWER: .....	4.4 kWh
HEIGHT: .....	3.9 ft	SPEED (KNOTS): CRUISE .....	2/6 hr
DRAFT: .....	2.25 ft	MAX .....	5/3 hr
WEIGHT (DRY): .....	1-man: 1.9 tons	CREW: PILOTS .....	1
	2-man: 1.2 tons	OBSERVERS .....	1 (2-man model)
OPERATING DEPTH: .....	100 ft	PAYLOAD: .....	NA
COLLAPSE DEPTH: .....	1,800 ft		
LAUNCH DATE: .....	1964		

**PRESSURE HULL:** Cylindrical shape composed of steel, 9.375 in. thick and 30-in. ID.

**BALLAST/BUOYANCY:** Internal ballast system (400 lb) which can be pumped dry by an electric motor or manually.

**PROPULSION/CONTROL:** A 1.5-hp, 24-VDC reversible electric motor in a pressure-resistant container drives a propeller mounted topside aft. Two bow planes and a rudder are manually maneuvered to obtain underway control.

**TRIM:** No systems.

**POWER SOURCE:** Four 185-amp-hr, 6-V, lead-acid batteries provide all power.

**LIFE SUPPORT:** Air within the pressure hull at time of hatch closure provides about 1 hr/passenger breathing. Soda Sorb used for CO<sub>2</sub> removal.

**VIEWING:** Cylindrical plastic dome (two on 2-man model) over hatch openings and one forward on bow. Domes are 0.5 in. thick on cylinder portion and 2.5 in. thick on plate portion.

**OPERATING/SCIENTIFIC EQUIPMENT:** Depth gage, radio, lights, remote compass. The Haight 1-man model has a hard line radio from vehicle to surface buoy.

**MANIPULATORS:** None.

**SAFETY FEATURES:** Droppable weight.

**SURFACE SUPPORT:** SOO.

**OWNER:** Various.

**BUILDOR:** Nautilette, Inc., Ft. Wayne, Indiana.

**REMARKS:** Three vehicles built, two 2-man and one 1-man, and are located as follows:

1-man: Mr. D. Haight, Warrensville, Ill. (used for salvage of wrecks).

2-man: Mr. C. Russner, Nashville, Mich.

2-man: Nautilette, Inc., Ft. Wayne, Ind. (used for commercial purposes).

All models are capable of operations within 48 hours.

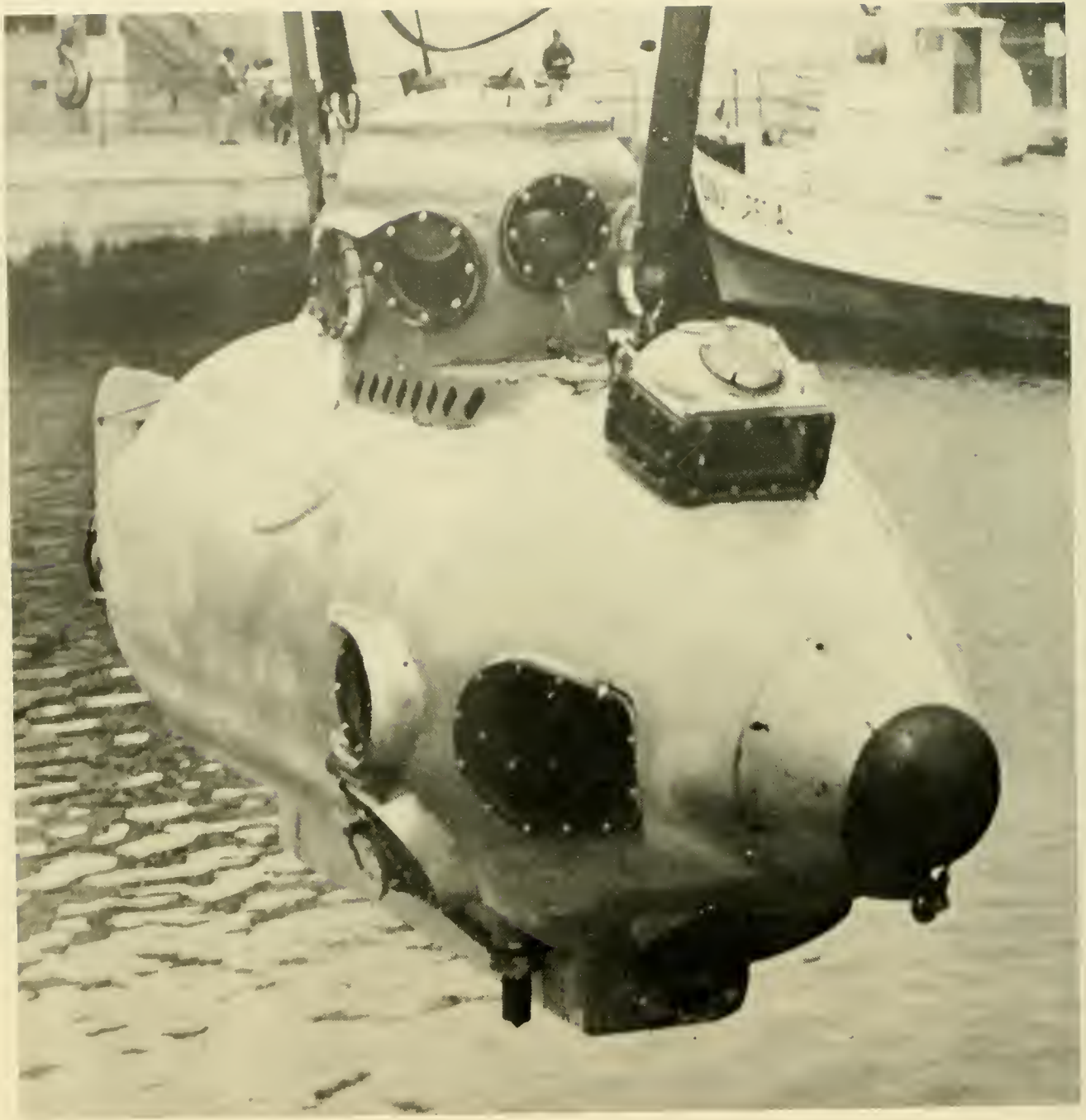



**NEKTON ALPHA, BETA, GAMMA**

LENGTH: ..... 15.5 ft  
 BEAM: ..... 5 ft  
 HEIGHT: ..... 6 ft  
 DRAFT: ..... 4 ft  
 WEIGHT (DRY): ..... 2.35 tons  
 OPERATING DEPTH: ..... 1,000 ft  
 COLLAPSE DEPTH: ..... 2,500 ft  
 LAUNCH DATE: ..... 1968, 70, 71

HATCH DIAMETER: ..... 18 in.  
 LIFE SUPPORT (MAX): ..... 48 man-hr  
 TOTAL POWER: ..... 4.5 kWh  
 SPEED (KNOTS): CRUISE ..... 1.5/3.5 hr  
                   MAX ..... 2.5/1 hr  
 CREW: PILOTS ..... 1  
           OBSERVERS ..... 1  
 PAYLOAD ..... 450 lb

**PRESSURE HULL:** Cylindrical shape of A-212 and A-515 (BETA, GAMMA) mild steel, 9/16 in. thick, 8-ft length and 42-in. ID. Conning tower is 24-in. diam. and 24 in. high of A-285 steel.

**BALLAST/BUOYANCY:** Vehicle launched positively buoyant, flooding of fore and aft ballast tanks (1,500-lb capacity each) produces 15 to 20 lb negative buoyancy for descent and during dive. Fine buoyancy control can be obtained by venting or blowing a 30-lb-capacity tank in pressure hull.

**PROPULSION/CONTROL:** One 3.5-hp Westinghouse M-15 electric motor (24-V) mounted on the stern within a pressure-resistant tank, drives a 10-in. diam. propeller. Mechanically actuated rudder provides lateral control and a starboard-mounted dive plane provides vertical control.

**TRIM:** Up/down bow angles are controlled by dive plane.

**POWER SOURCE:** Eight 6-V, 190-amp-hr, lead-acid batteries, wired for 24 V and 48 V, carried in a pressure-resistant compartment.

**LIFE SUPPORT:** Compressed O<sub>2</sub> is carried in the pressure hull in two tanks, one tank is of 50-ft<sup>3</sup> capacity and the other is of 25-ft<sup>3</sup>, both are at 1,800 psi. CO<sub>2</sub> is removed by blowing air through Baralyme cannisters of which four each are carried (2 lb Baralyme/cannister). An aircraft altimeter is used to measure ambient cabin pressure.

**VIEWING:** Seventeen acrylic plastic viewports are provided which are flat discs 6.5 in. in diameter and 1.25 in. thick.

**OPERATING/SCIENTIFIC EQUIPMENT:** UQC (8-kHz) 2,000-yd range, needle type depth gage (0-1,300 ft), scanning sonar (audio, variable frequency), Straza-type tracking system (37-kHz), compass, directional gyro, echo sounder, sample bag.

**MANIPULATORS:** One hand-operated manipulator consisting of a 3-ft long rod penetrating the starboard side of the pressure hull through a stuffing gland and terminating in a 3-pronged grasping device can be manipulated by the observer to obtain suitable samples or artifacts.

**SAFETY FEATURES:** Emergency breathing provided by two scuba regulators attached to a high pressure air system (72-ft<sup>3</sup> capacity). Mechanically-droppable, 75-lb lead weight, propeller-rudder assembly droppable (40 lb), ballast tanks and trim tank blowable at maximum operating depth (1,040 lb total).

**SURFACE SUPPORT:** Supported and launched/retrieved at sea by either R/V SEAMARK or R/V DAWN STAR. Launch/retrieval from SEAMARK by a non-articulated boom, from DAWN STAR by an "A" frame type apparatus. A total of four people is required to support and operate the submersible and support ship (DAWN STAR) at sea.

**OWNER:** General Oceanographics, Inc., Irvine, California.

**BUILDER:** NEKTON, Inc., a subsidiary of General Oceanographics.

**REMARKS:** All operational. NEKTON ALPHA varies from sister submersibles in the following: length 15 ft, weight 2.25 tons, payload 300 lb, and in its topside bow viewport configuration.

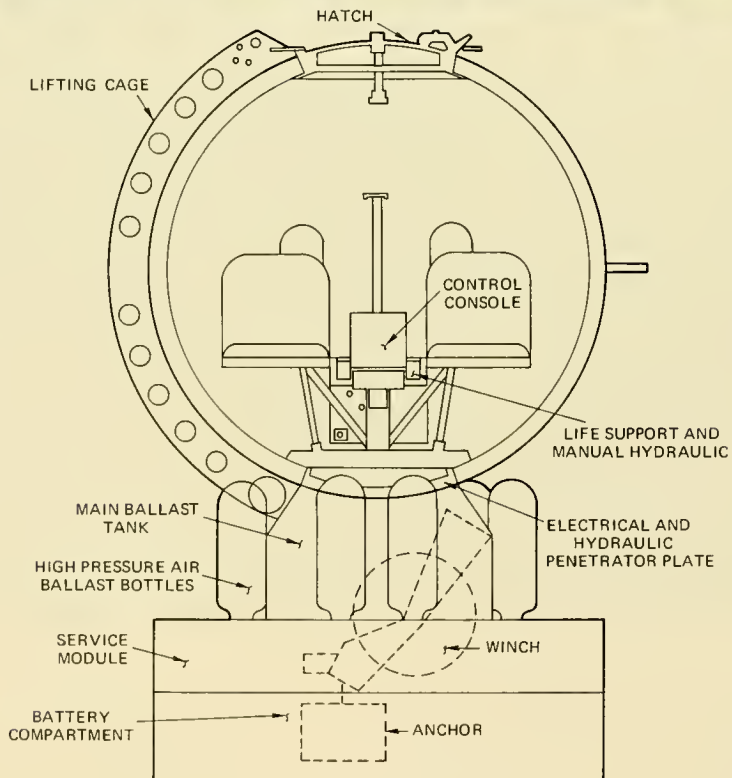
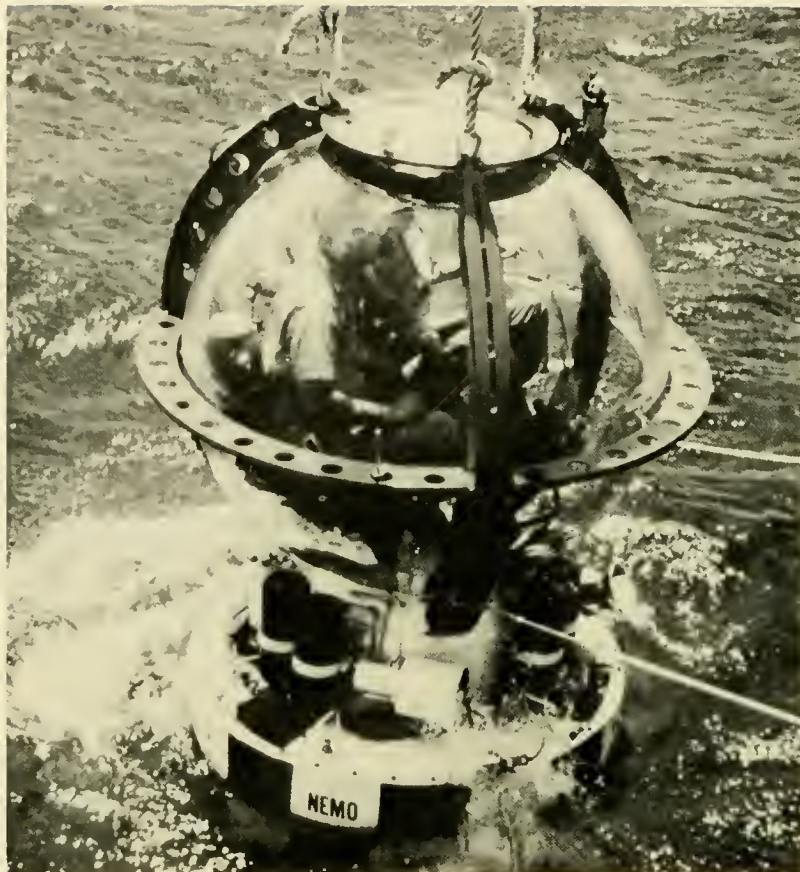

## NEMO

LENGTH: ..... 7.5 ft  
 BEAM: ..... 7.5 ft  
 HEIGHT: ..... 9.2 ft  
 DRAFT: ..... 1 ft  
 WEIGHT (DRY): ..... 4 tons  
 OPERATING DEPTH: ..... 600 ft  
 COLLAPSE DEPTH: ..... 4,150 ft  
 LAUNCH DATE: ..... 1970

HATCH DIAMETER: ..... 18.7 in.  
 LIFE SUPPORT (MAX): ..... 64 man-hr  
 TOTAL POWER: ..... 15 kWh  
 SPEED (KNOTS): CRUISE ..... 0.75/8 hr  
                           MAX ..... NA  
 CREW: PILOTS ..... 1  
           OBSERVERS ..... 1  
 PAYLOAD ..... 850 lb (incl. crew)

**PRESSURE HULL:** Acrylic plastic (Plexiglas G) sphere composed of 12 spherical pentagons bonded together with adhesive. Hull is 66-in. OD and 2.5 in. thick. Top (hatch) and bottom plates are of cadmium-plated 4130 steel. Bottom plate is for passage of penetrators. Hull weighs 1,500 lb in air and displaces 5,500 lb in water.

**BALLAST/BUOYANCY:** Main ballast is supplied by an 8-ft<sup>3</sup> capacity free-flooding cylindrical tank below the pressure hull. Deballasting is accomplished by six 50-ft<sup>3</sup> capacity air bottles at 2,250 psi, which make available 19-ft<sup>3</sup> (371 SCF) of air at 600-ft depth and allow two complete cycles at this depth. A free-flooding auxiliary ballast tank aft has a capacity of 2 ft<sup>3</sup>.

**PROPULSION/CONTROL:** Two 1.5-hp hydraulic motors mounted on each side of the vehicle drive 8-in. diam., shrouded propellers, which serve to rotate the vehicle in the lateral plane and to allow short excursions when at neutral buoyancy. Within the service module is a hydraulically-driven winch (1,200 ft of 0.25-in. wire ropes) which the pilot can operate to provide vertical excursions (anchor weight 380 lb).

**TRIM:** Not required.

**POWER SOURCE:** Main power is from twenty-one 6-V, 150-amp-hr. pressure-compensated, lead-acid batteries supplying 120 V. Secondary power is supplied by a 20-amp-hr. silver-zinc battery carried within the pressure sphere.

**LIFE SUPPORT:** O<sub>2</sub> is stored in two 50-ft<sup>3</sup>-capacity tanks at 1,600 psi and automatically bled into the sphere at a selected rate. CO<sub>2</sub> is removed by blowing air through an 8-lb cannister of Baralyme. Silica gel (50-in.<sup>3</sup>) removes water vapor. Partial pressure of O<sub>2</sub>, cabin pressure and CO<sub>2</sub> content are continuously monitored, a Drager kit serves as backup measuring device.

**VIEWING:** Panoramic viewing through the plastic pressure hull.

**OPERATING/SCIENTIFIC EQUIPMENT:** UQC (8.08-kHz).

**MANIPULATORS:** None.

**SAFETY FEATURES:** Two closed-circuit O<sub>2</sub> rebreathers for emergency use. Internal emergency power supply can actuate anchor cable cutter drop battery pack (2,170 lb in air), blow ballast tanks and operate normal life support system. There is also a manual anchor cable cutter.

**SURFACE/SHORE SUPPORT:** Air, ship, truck transportable. Launched/retrieved at sea from any ship of 100 tons or greater with an over-the-side handling capacity of at least 10 tons.

**OWNER:** U.S. Naval Undersea Center, San Diego, California.

**BUILDER:** U.S. Naval Civil Engineering Laboratory, Port Hueneme, California.

**REMARKS:** Not operating. Now at Southwest Research Inst.

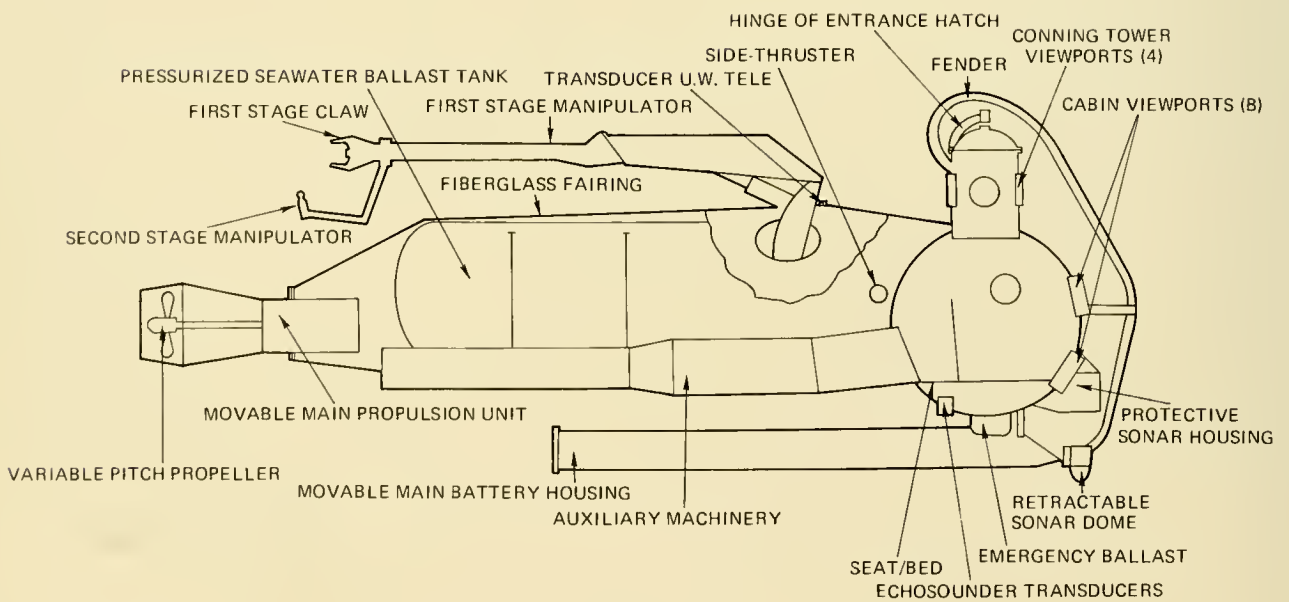
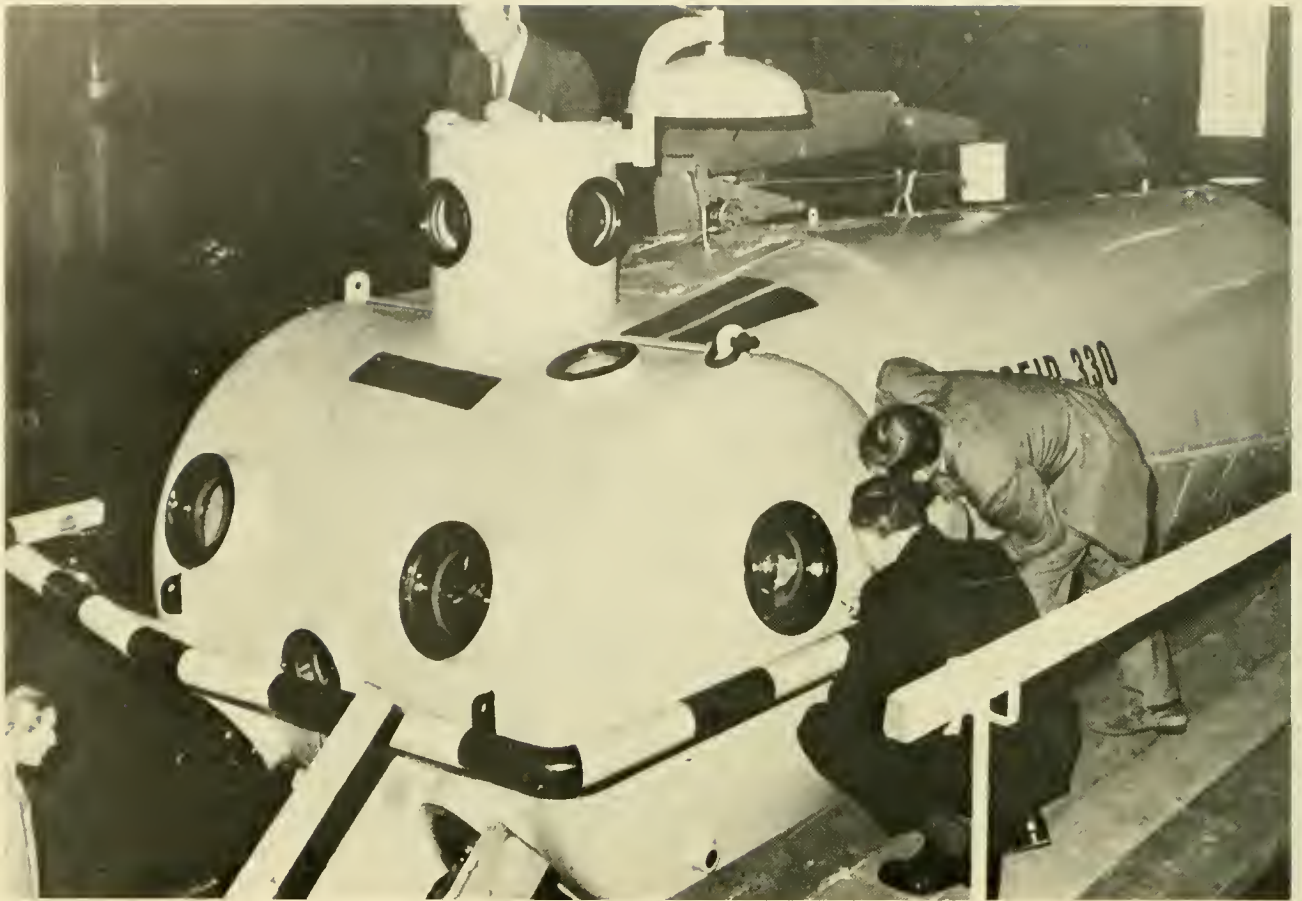

## NEREID 330

LENGTH: ..... 29 ft  
 BEAM: ..... 11 ft  
 HEIGHT: ..... 11 ft  
 DRAFT: ..... 7 ft  
 WEIGHT (DRY): ..... 11 tons  
 OPERATING DEPTH: ..... 330 ft  
 COLLAPSE DEPTH: ..... 500 ft  
 LAUNCH DATE: ..... 1972

HATCH DIAMETER: ..... 22.8 in.  
 LIFE SUPPORT (MAX): ..... 96 man-hr  
 TOTAL POWER: ..... 40 kWh  
 SPEED (KNOTS): CRUISE ..... 2/8 hr  
                   MAX ..... 4  
 CREW: PILOTS ..... 1  
           OBSERVERS ..... 2  
 PAYLOAD: ..... 5,500 lb

**PRESSURE HULL:** Cylindrical shape steel hull, OD of 70 in. symmetrical axis perpendicular to fore-aft axis. Dished ends. Two cylindrical extensions, OD of 20 in. on port and starboard side, length of 13 ft.

**BALLAST/BUOYANCY:** Main ballast tank is half filled with seawater and air compressed at a higher pressure than the 330-ft operating depth; to obtain negative buoyancy a pump is used to add more water. To obtain positive buoyancy a purge valve is opened which blows the main ballast dry. One 200-l atmospheric tank provides auxiliary negative buoyancy.

**PROPULSION/CONTROL:** A stern-mounted, laterally-trainable, variable-pitch propeller driven by a 10-hp motor provides main horizontal propulsion. A 2.5-hp lateral thruster mounted aft of the pressure hull assists in fine maneuvering control.

**TRIM:** Up/down bow angles of 30° are obtainable by hydraulically moving the main battery housing fore or aft.

**POWER SOURCE:** Nine 12-V each, lead-acid batteries are carried in two longitudinal pressure-resistant tubes below the vehicle and deliver 200 V. Four 12-V, lead-acid batteries supply 24 V.

**LIFE SUPPORT:** Two 12-l-capacity tanks.

**VIEWING:** Thirteen viewports.

**OPERATING/SCIENTIFIC EQUIPMENT:** UQC, CTFM, gyrocompass, depth indicator speed log, downward-looking echo sounder.

**MANIPULATORS:** Two; one is 15 ft long and capable of 2,500-lb lift; the second is a smaller one attached to the larger arm which is used to perform delicate operations. Installed on starboard side near center of buoyancy. Gripping force of the large claw is 6 tons.

**SAFETY FEATURES:** Internally-pressurized buoyancy tank may be blown by entrapped air to operational depth. Hand released reserve ballast (700 lb). Emergency breathing equipment for leaving flooded hull through escape hatch.

**SURFACE SUPPORT:** SOO.

**OWNER:** Nereid nv. Schiedam, Holland.

**BUILDER:** Same as above.

**REMARKS:** Operating. A 700-ft lock-out NEREID 700 was scheduled for launching in 1973, but nothing has been heard of this project since May 1973.

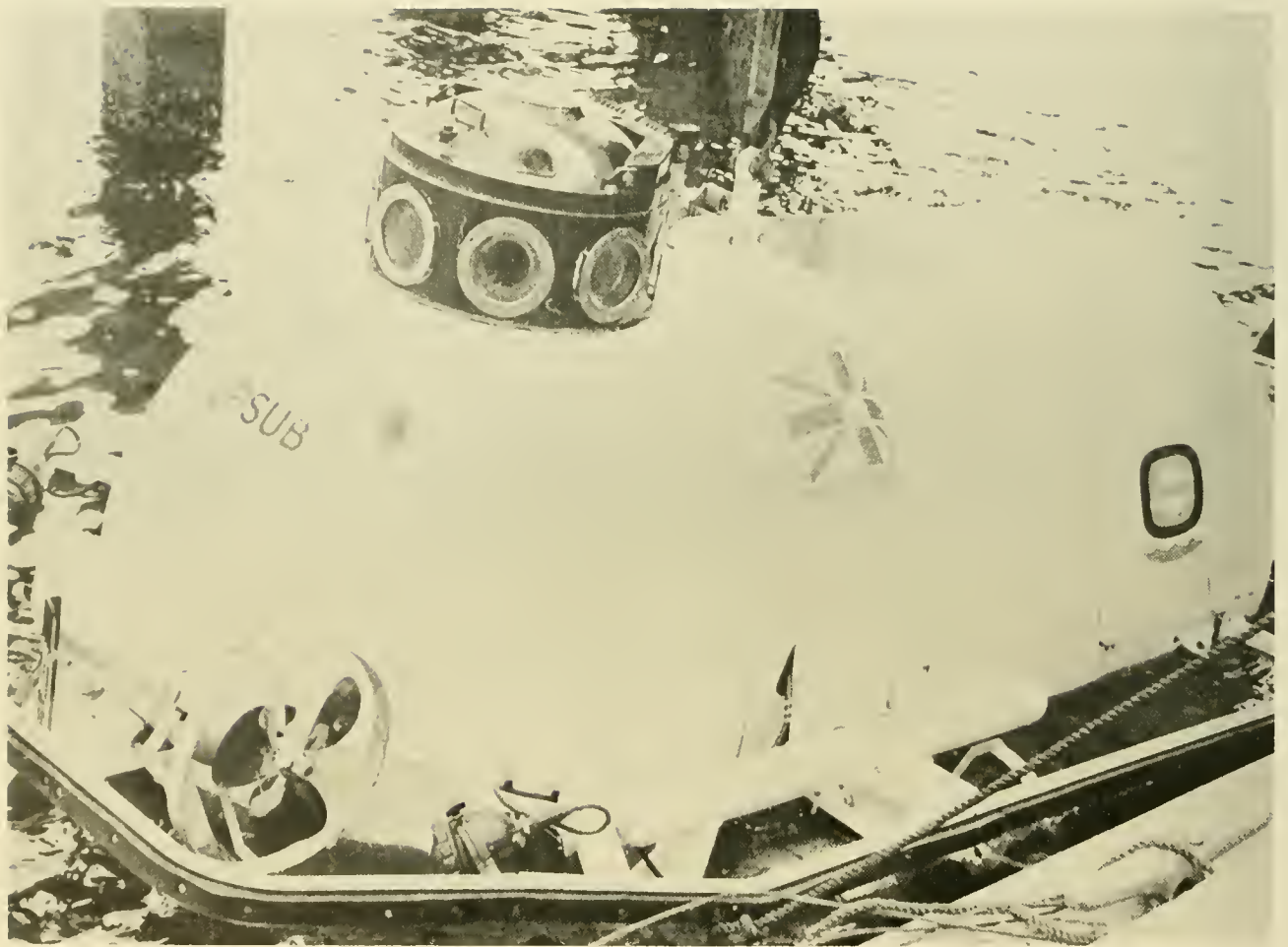

## OPSUB

LENGTH: ..... 18 ft  
BEAM: ..... 8.5 ft  
HEIGHT: ..... 7.5 ft  
DRAFT: ..... 6 ft (est.)  
WEIGHT (DRY): ..... 5.2 tons  
OPERATING DEPTH: ..... 2,000 ft  
COLLAPSE DEPTH: ..... NA  
LAUNCH DATE: ..... 1972

HATCH DIAMETER: ..... NA  
LIFE SUPPORT (MAX): ..... 48 man-hr  
TOTAL POWER: ..... Tethered  
SPEED (KNOTS): CRUISE ..... NA  
                  MAX ..... 2  
CREW: PILOTS ..... 1  
      OBSERVERS ..... 1  
PAYLOAD: ..... 750 lb

**PRESSURE HULL:** Spherical shape, 66-in. OD, 0.5 in. thick and composed of HY-80 steel.

**BALLAST/BUOYANCY:** Large weight changes are compensated for before the dive by changing external weights in the fixed ballast compartment on a droppable weight platform. Small buoyancy changes during the dive are obtained through a variable ballast tank (200-lb capacity). The tank is flooded to fill and pumped dry.

**PROPULSION/CONTROL:** Five motors provide propulsion. Three are for horizontal motion and are mounted port, starboard and aft, the aft motor is trainable 90° left and right. The remaining two motors are thrusters for horizontal and vertical control. All motors are oil-compensated, 10-hp, 350-lb thrust, and are reversible with two speeds forward and aft.

**TRIM:** No systems provided.

**POWER SOURCE:** An umbilical from the surface provides 50 kW of power from a diesel generator providing 440-VAC regulated power. Communications, TV transmission and voltage sensing also passes through this wire. The umbilical is 1,000 ft long, 1.4-in. diam. and has a breaking strength of 10,000 lb, it can be cut by the vehicle if the need arises.

**LIFE SUPPORT:** Three O<sub>2</sub> flasks are carried in the hull. CO<sub>2</sub> is removed by Baralyme in a forced-air scrubber. O<sub>2</sub> is monitored by a Teledyne Analyzer, CO<sub>2</sub> is monitored by a Dräger Analyzer, a second Dräger Analyzer (Multi-gas Detector Mod. 21) measures both CO<sub>2</sub> and CO. An altimeter measures cabin pressure. Two scuba bottles (compressed air) and regulators provide emergency breathing for approximately 4 man-hr.

**VIEWING:** There are 13 viewports total. Four are in the hull, eight in the conning tower and one in the hatch.

**OPERATING/SCIENTIFIC EQUIPMENT:** UQC and hard wire communications, scanning sonar, TV, 35-mm still camera & strobe, two depth gages, directional gyro.

**MANIPULATORS:** None.

**SAFETY FEATURES:** A 600-lb, droppable weight, emergency breathing, backup communications on batteries, umbilical cutter, running lights, fire extinguisher, life jackets, underwater flashlights.

**SURFACE SUPPORT:** SOO.

**OWNER:** Phillips Petroleum, Bartlesville, Okla.

**BUILDER:** Perry Submarine Builders, Riviera Beach, Fla.

**REMARKS:** Inactive, has not made an operational dive.

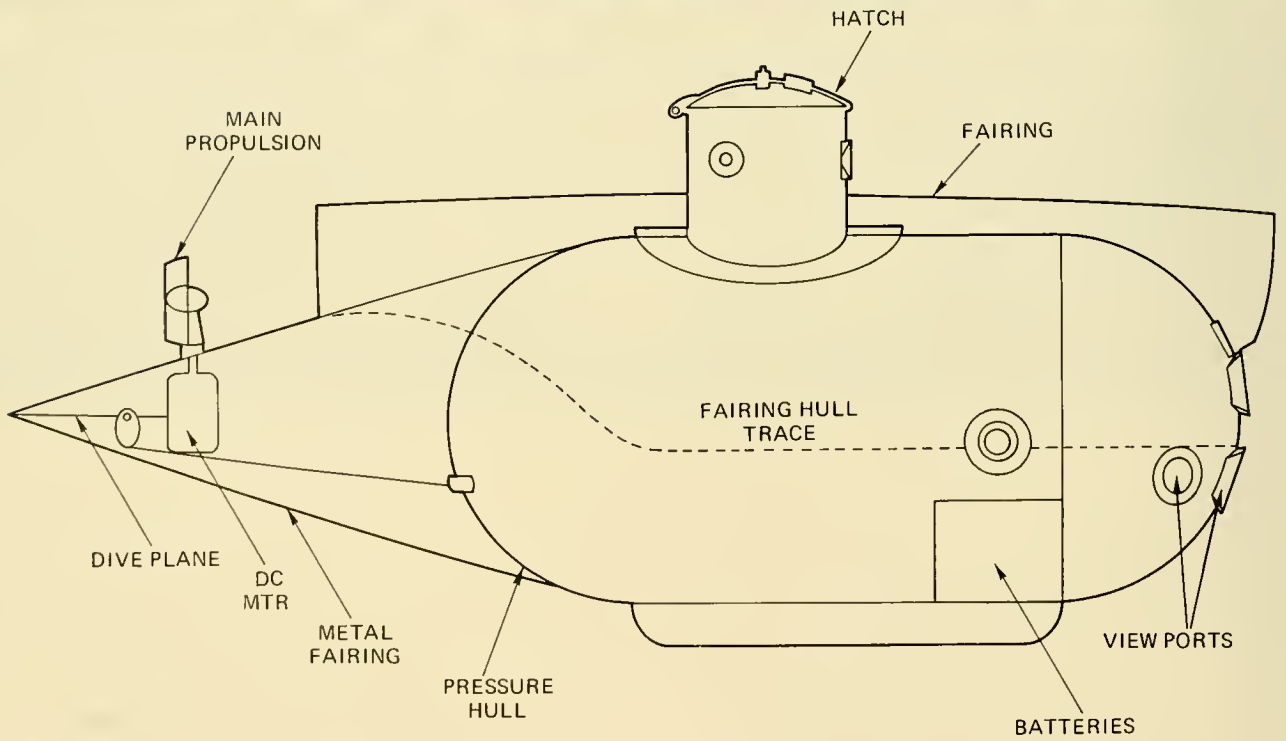



PAULO I

LENGTH ..... 13.5 ft  
 BEAM: ..... 4.5 ft  
 HEIGHT: ..... 6.3 ft  
 DRAFT: ..... 4.5 ft  
 WEIGHT (DRY): ..... 2.6 tons  
 OPERATING DEPTH: ..... 600 ft  
 COLLAPSE DEPTH: ..... 3,650 ft  
 LAUNCH DATE: ..... 1967

HATCH DIAMETER: ..... 20-3/4 in.  
 LIFE SUPPORT (MAX): ..... 96 man hr  
 TOTAL POWER: ..... 5.2 kWh  
 SPEED (KNOTS): CRUISE ..... 0.75/25 hr  
                           MAX ..... 3/10 hr  
 CREW: PILOTS ..... 1  
           OBSERVERS ..... 1  
 PAYLOAD: ..... 480 lb

**PRESSURE HULL:** Cylindrical shape with hemispherical endcaps. Cylinder is 4-ft. ID, 8 ft long and 0.75 in. thick of A 212 steel. Endcaps and hatch are 0.5 in. thick of a 212B steel.

**BALLAST/BUOYANCY:** Main and fairwater ballast tanks provide 480 and 3,000 lb positive/negative buoyancy, respectively.

**PROPULSION/CONTROL:** A stern-mounted, 11-in. diam. propeller is driven by a 4-hp Bendix, 4,000-rpm, 30-amp motor. Propeller may be trained mechanically left or right and is reversible.

**TRIM:** Ten 6-in. OD, 40-in.-long tanks of 48-lb capacity each may be vented or blown to adjust trim.

**POWER SOURCE:** Four 6 V, 217-amp-hr. each lead-acid batteries provide 6, 12, or 24 V through a selector switch to provide main power supply. Auxiliary power is from two 92-amp-hr each lead-acid batteries.

**LIFE SUPPORT:** O<sub>2</sub> is carried in two 70-ft<sup>3</sup>-capacity tanks at 2,200 psi with automatic flow adjustment. A blower circulates air through a soda sorb cannister to remove CO<sub>2</sub>.

**VIEWING:** Ten acrylic plastic viewports. Six are in the pressure hull forward area and are 4 in. ID, 8 in. OD and 2 in. thick. Four girdle the conning tower and one is in the hatch which is 2 in. ID, 4-in. OD and 1 in. thick.

**OPERATING/SCIENTIFIC EQUIPMENT:** UQC (42-kHz), Bendix Magnesyn compass, depth gage, echo sounder, altimeter and differential pressure gage.

**MANIPULATORS:** None.

**SAFETY FEATURES:** Mechanically droppable keel (100 lb). Main and fairwater ballast tanks can be blown by divers from surface ship. Pressure hull can be pressurized and opened for emergency exit.

**SURFACE/SHORE SUPPORT:** SOO.

**OWNER:** Previous owner: Anautics Inc., San Diego, Calif.

**BUILDER:** Same as above.

**STATUS:** Sold in 1971 to Candive Ltd., Vancouver, B.C. and leased on long-term basis to Arctic Marine, Ltd., Vancouver, B.C. who reconfigured it into the present SEA OTTER.

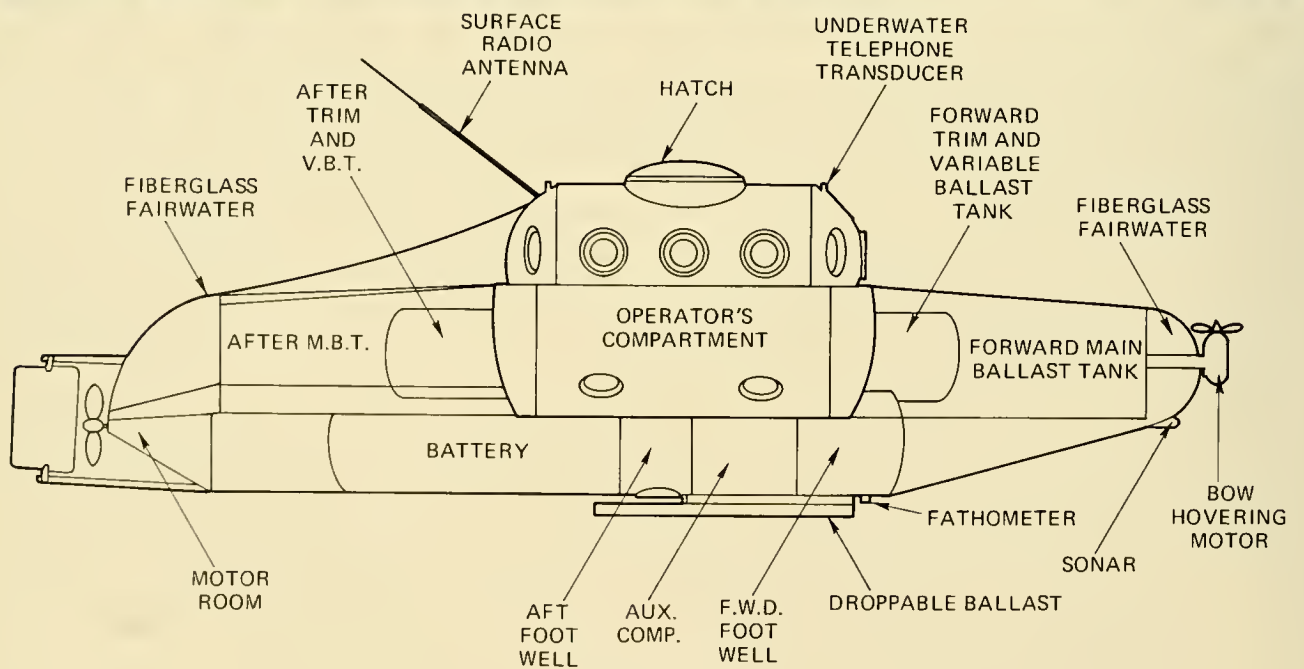

## PC-3A1 & 2

LENGTH: ..... 18.5 ft  
BEAM: ..... 3.5 ft  
HEIGHT: ..... 5.75 ft  
DRAFT: ..... 3.5 ft  
WEIGHT (DRY): ..... 4,790 lb  
OPERATING DEPTH: ..... 300 ft  
COLLAPSE DEPTH: ..... 500 ft  
LAUNCH DATE: ..... 1964; 1966

HATCH DIAMETER: ..... 19 in.  
LIFE SUPPORT (MAX): ..... 20 man-hr  
TOTAL POWER: ..... 7.5 kWh  
SPEED (KNOTS): CRUISE ..... 2/8 hr  
MAX ..... 4.5/5 hr  
CREW: PILOTS ..... 1  
OBSERVERS ..... 1  
PAYLOAD: ..... 750 lb

**PRESSURE HULL:** Main hull, motor room and battery compartment are of 0.25-in.-thick A285 steel. Canopy is 0.25-in.-thick plate, heads are of A285 steel. Hatch trunk is 0.5-in. S.S.ASTM A 351 casting and hatch cover is Almag 335 casting. Mechanical penetrations in hull are for propeller shaft, hatch opening shaft and droppable keel operating shaft. Motor room is separated from batteries and operators by a wall capable of withstanding full ambient pressure at operating depth.

**BALLAST/BUOYANCY:** Main ballast tanks are made of 11 & 12 gage A285 steel and located fore and aft to provide displacement of 1,250 lb. Trim tanks may also be employed to provide 320 lb displacement.

**PROPULSION/CONTROL:** Main propulsion is from a stern-mounted, 7-hp, 36-V, 855-rpm, Allis Chalmers motor with infinitely variable speed control. Hydraulically-operated rudder and bow planes provide horizontal and vertical maneuvering. Bow or stern thrusters of fractional hp are available if required.

**TRIM:** Two tanks, 0.25 in. thick, of A285 steel, 160-lb capacity each can be blown or pumped to and from seawater or fore and aft from one tank to the other. Valves and piping are stainless steel of non-corrosive 600-psi test minimum. Trim pump is a Hypro 3.1 gpm at 200 psi driven by a G. E. 0.5 hp, 15-amp, 32-V motor.

**POWER SOURCE:** Six 6-V, 210-amp-hr, Excel, lead-acid batteries, type GRP 6, are located in a pressure-resistant, gas-tight compartment. Optionally, silver cadmium (72 Yardney Ys-200) or silver-zinc (100 Yardney LR-200) batteries may be used to extend cruising time to 10 and 20 hr, respectively.

**LIFE SUPPORT:** CO<sub>2</sub> removal by Baralyme (4-qt supply) through which air is drawn by two 72-cfm Vane-Axial Blowers. One external 70-ft<sup>3</sup>, 2,200 psi O<sub>2</sub> bottle connected to reducer to flowmeter and regulator. Low pressure air is connected to the scuba regulators which can be used in an emergency.

**VIEWING:** Seventeen viewports through vehicle, thickness is 1.0 in.; ID of 6.5 in.; OD of 8 in.

**OPERATING/SCIENTIFIC EQUIPMENT:** UQC, magnetic compass, depth gage.

**MANIPULATORS:** None.

**SAFETY FEATURES:** Pressure hull can be pressurized and flooded for escape. By blowing ballast tanks or dropping solid ballast the following positive buoyancy can be obtained: Main ballast tank 1,250 lb, trim tanks 320 lb, keel 180 lb. Emergency air is obtained through scuba regulators and hoses off the low pressure air supply. Ballast tanks can be blown through external connections.

**SURFACE SUPPORT:** SOO.

**OWNER:** U.S. Army and U.S. Air Force.

**BUILDER:** Perry Submarine Builders, Riviera Beach, Fla.

**REMARKS:** Operating. Kentron Ltd. of Hawaii operates these vehicles for the Air Force and Army.

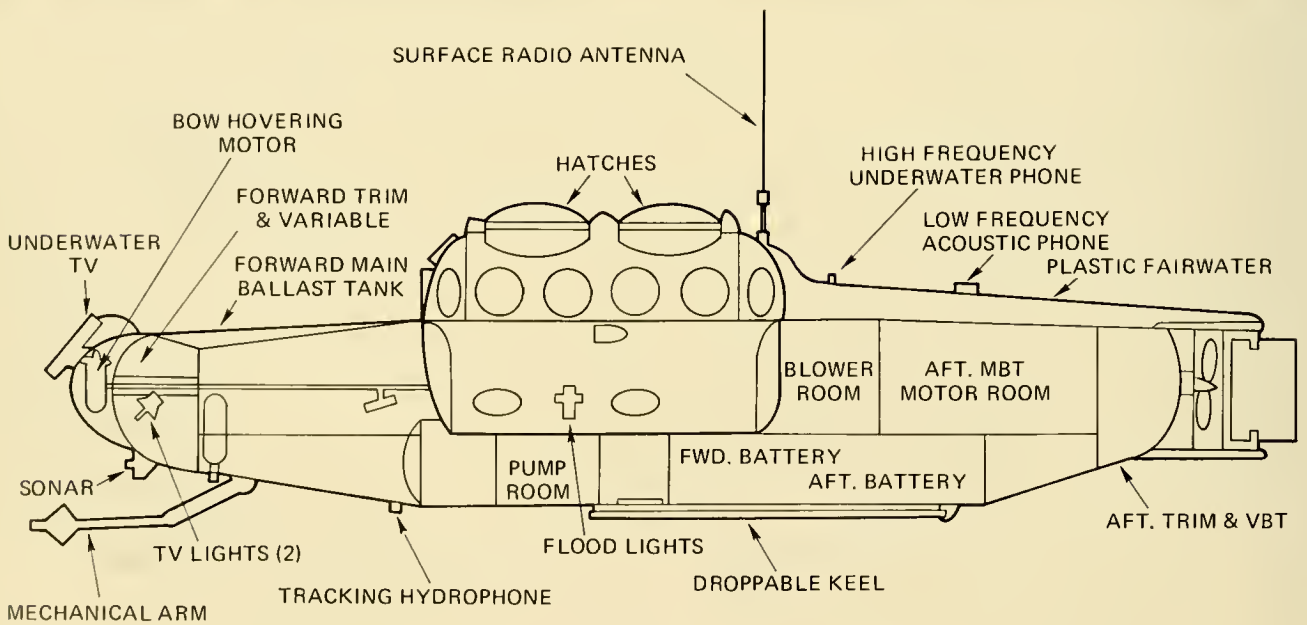

PC-3B

LENGTH: ..... 22 ft  
BEAM: ..... 3,5 ft  
HEIGHT: ..... 5,75 ft  
DRAFT: ..... 3,5 ft  
WEIGHT (DRY): ..... 2,75 tons  
OPERATING DEPTH: ..... 600 ft  
COLLAPSE DEPTH: ..... 900 ft  
LAUNCH DATE: ..... 1963

HATCH DIAMETER: ..... 19 in.  
LIFE SUPPORT (MAX): ..... 40 man-hr  
TOTAL POWER: ..... 10 kWh  
SPEED (KNOTS): CRUISE ..... 1.75/10 hr  
MAX ..... 4/2 hr  
CREW: PILOTS ..... 1  
OBSERVERS ..... 1  
PAYLOAD: ..... 300 lb

**PRESSURE HULL:** Main hull of 0,5-in.-thick plate and heads of A212 steel. Canopy of 0,25-in.-thick plate and 3/8-in. heads of A212 steel. Motor room & battery compartment 0,25-in. plate and heads of A212 steel. Hatch trunk is 0,5-in.-thick S.S.ASTM A-351 casting; hatches are Almag 335 castings. Mechanical penetrations in hull are for propeller shaft with crane seal backed up by pneumatically operated seal; two hatch openings and one droppable keel operating shaft.

**BALLAST/BUOYANCY:** Main ballast tanks made of 11 & 12 gage A285 steel are located fore and aft and provide a displacement of 2,000 lb. Trim tanks may also be employed to provide 400-lb displacement.

**PROPULSION/CONTROL:** Main propulsion is from a stern-mounted, 7-hp, 36-V, 855-rpm, Allis Chalmers motor with infinitely variable speed controls. Hydraulically-actuated rudder and bow planes provide horizontal and vertical underway maneuvering. Bow or stern thrusters of fractional hp available.

**TRIM:** Two tanks, 0,25 in. thick, of A212 steel 200-lb capacity each can be blown or pumped to and from seawater or fore and aft from one tank to the other. Valves and piping are of stainless steel or other non-corrosive material. Trim pump is a Hypro 6 gpm at 400 psi driven by a 2,5-hp, 36-V 60-amp, Milwaukee motor.

**LIFE SUPPORT:** CO<sub>2</sub> removal by Baralyme (4-qt supply) through which air is drawn by two 72-cfm Vane-Axial blowers. O<sub>2</sub> is supplied from one externally-mounted 70-ft<sup>3</sup>, 2,200-psi bottle connected to reducer to flowmeter and regulator. Two scuba regulators within the vehicle are connected to the low pressure air supply for emergency breathing.

**POWER SOURCE:** Either silvercel batteries or 10 lead-acid batteries may be used which are located in a pressure-resistant compartment just above the keel and aft. The silvercel batteries extend cruising time by a factor of 2 over the lead-acid batteries.

**VIEWING:** Seventeen viewports throughout the vehicle of 1,5-in. thickness, ID of 6 in.; OD of 8 in.

**OPERATING/SCIENTIFIC EQUIPMENT:** UQC, radio, echo sounder, magnetic compass, forward-scanning sonar.

**MANIPULATORS:** None.

**SAFETY FEATURES:** Pressure hull can be pressurized and flooded for escape. By blowing tanks or dropping ballast the following positive buoyancy can be obtained: main ballast tank 200 lb, trim tanks 400 lb, weight drop 75 lb. Main ballast tanks can receive air from ship or scuba diver with air bottle.

**SURFACE SUPPORT:** SOO.

**OWNER:** International Underwater Contractors, New York.

**BUILDER:** Perry Submarine Builders, Riviera Beach, Fla.

**REMARKS:** Has not dived for several years, but can be available on short notice if required. Renamed TECHDIVER when purchased by its present owner.

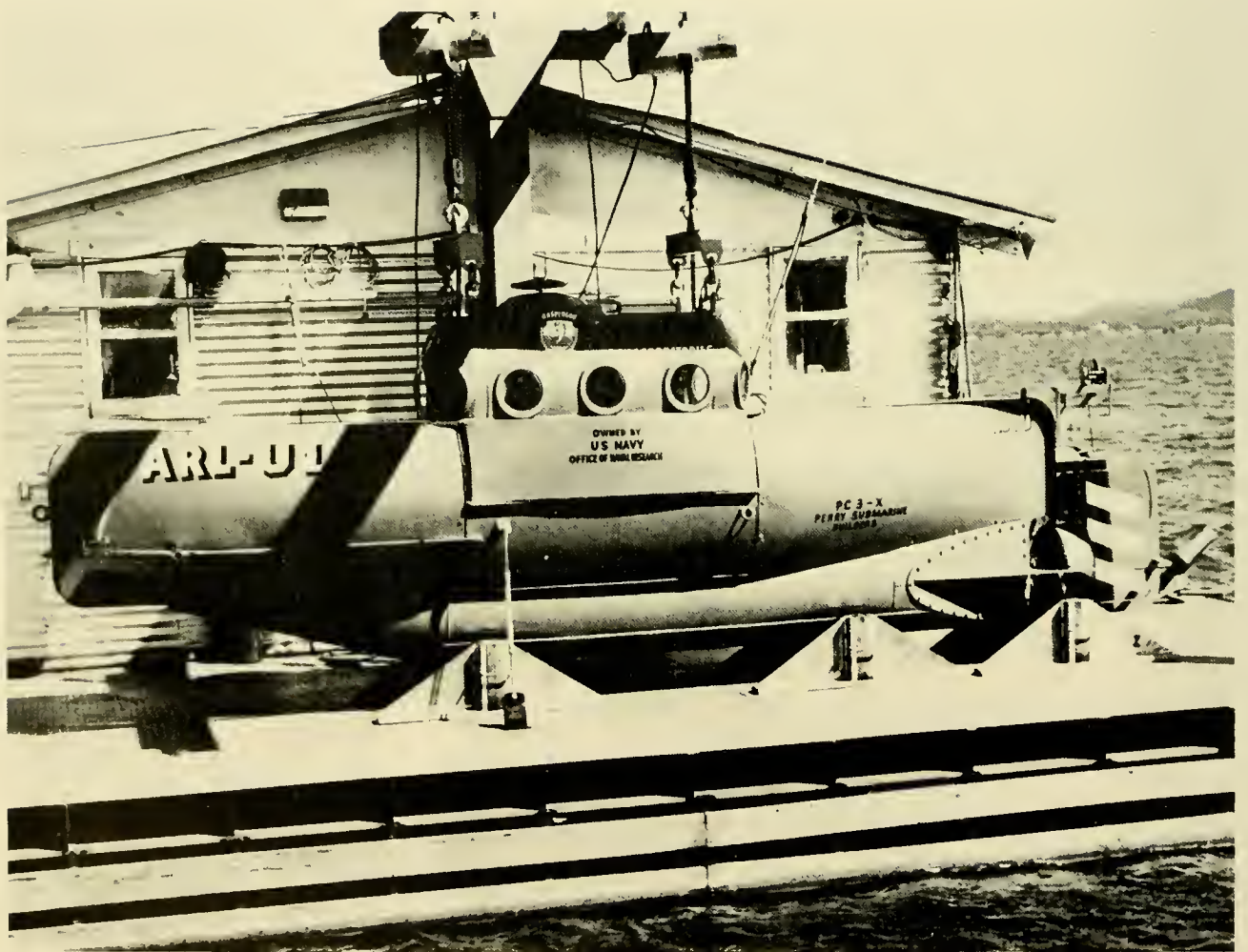

PC3-X

LENGTH: ..... 20 ft  
BEAM: ..... 3.5 ft  
HEIGHT: ..... 5 ft  
DRAFT: ..... 3.75 ft  
WEIGHT (DRY): ..... 4,700 lb  
OPERATING DEPTH: ..... 150 ft  
COLLAPSE DEPTH: ..... 500 ft  
LAUNCH DATE: ..... 1962

HATCH DIAMETER: ..... 19 in.  
LIFE SUPPORT (MAX): ..... 16 man-hr  
TOTAL POWER: ..... 11 kWh  
SPEED (KNOTS): CRUISE ..... 2/6 hr  
                  MAX ..... 4/3 hr  
CREW: PILOTS ..... 1  
          OBSERVERS ..... 1  
PAYLOAD: ..... 100 lb

**PRESSURE HULL:** Composed of 0.25-in.-thick plate and heads of A285 steel.

**BALLAST/BUOYANCY:** Main ballast tanks fore and aft which are free flooding and blown by compressed air in four bottles (270-ft<sup>3</sup> total capacity) at 2,000 psi. Two variable ballast tanks fore and aft which are pumped dry to the sea or from one tank to the other.

**PROPULSION/CONTROL:** One, stern-mounted, reversible propeller provides all propulsion. It is powered by a 4-hp, 115-VDC, 32-amp motor enclosed in a separate water-tight compartment. Bow planes and rudder are hydraulically actuated by the pilot using airplane-type controls.

**TRIM:** Up/down bow angle can be achieved to a moderate degree by differentially filling the VBT's.

**POWER SOURCE:** Six 6-V, lead-acid batteries rated at 210 amp-hr each are carried in a pressure-resistant compartment.

**LIFE SUPPORT:** NA.

**VIEWING:** Thirteen viewports located around the conning tower, 0.5 in. thick.

**OPERATING/SCIENTIFIC EQUIPMENT:** Magnesyn compass, echo sounder, two depth gages, CB radio, UQC, forward-looking sonar, transponder.

**MANIPULATORS:** None.

**SAFETY FEATURES:** Emergency breathing through scuba regulator off high pressure deballasting air. Pressure hull may be flooded for passenger egress. External fitting to receive air from divers, Life vests.

**SURFACE SUPPORT:** SOO.

**OWNER:** Applied Research Laboratory, Univ. of Texas, Austin, Texas.

**BUILDER:** Perry Submarine Builders, Riviera Beach, Fla.

**REMARKS:** This is the first Perry CUBMARINE considered a production-type vehicle (it was the third one built). It now dives occasionally in Lake Travis, Texas. Its present owner has designated it the GASPERGOU. At one point in its diving history it was called SUB-ROSA.

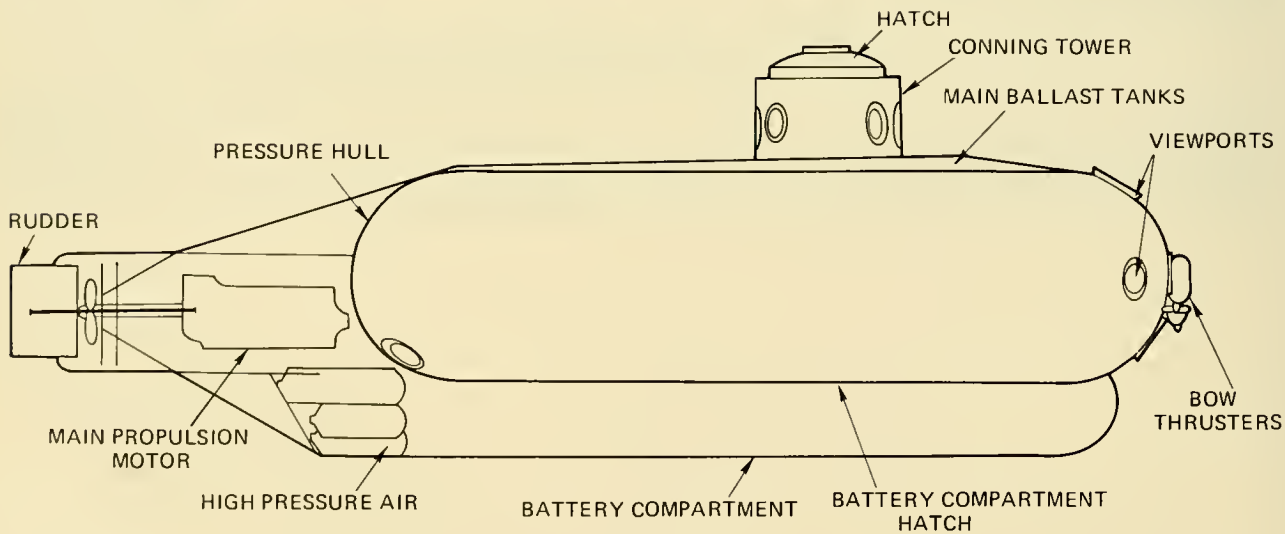
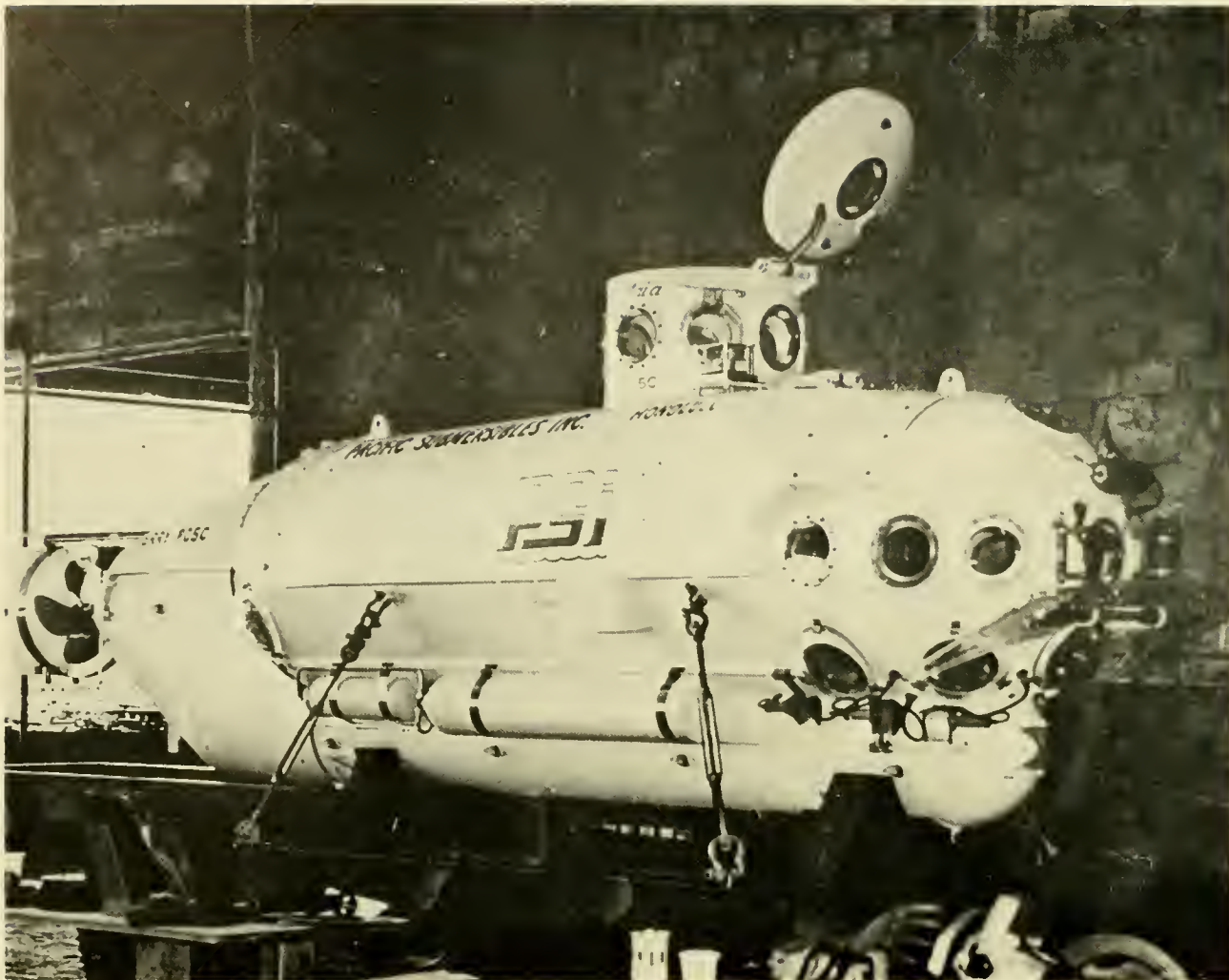



## PC5C

LENGTH: ..... 22.3 ft  
BEAM: ..... 4.1 ft  
HEIGHT: ..... 7.1 ft  
DRAFT: ..... 4.75 ft  
WEIGHT (DRY): ..... 11,450 lb  
OPERATING DEPTH: ..... 1,200 ft  
COLLAPSE DEPTH: ..... 2,000 ft  
LAUNCH DATE: ..... 1968

HATCH DIAMETER: ..... 23 in.  
LIFE SUPPORT (MAX): ..... 180 man-hr  
TOTAL POWER: ..... 16 kWh  
SPEED (KNOTS): CRUISE ..... 0.5/4 hr  
                  MAX ..... 6.5/0.5 hr  
CREW: PILOTS ..... 1  
      OBSERVERS ..... 2  
PAYLOAD: ..... 725 lb

**PRESSURE HULL:** Passenger compartment is a stiffened cylinder with hemispherical endcaps. Main hull and battery compartment is 0.5-in.-thick, SA 212 grade B steel; conning tower and motor room are 3/8-in. SA 212 grade B steel; hatch is Almag 35 steel. Passenger, motor, and battery compartments have separate, water-tight integrity.

**BALLAST/BUOYANCY:** Buoyancy control tanks, made of 18 gage, 304 stainless steel, are located within the hull and have a total capacity of 260 lb. A hydropump (4 gpm; 700 psi) can pump from tanks to sea or sea to tanks or bilges to tanks. The pump motor is a G.E., 120-V, 2-hp at 750 rpm. Main ballast tanks straddle the pressure hull.

**PROPULSION CONTROL:** Stern-mounted propeller provides main horizontal propulsion and is driven by a 10-hp motor. Two bow and one stern thruster of fractional hp are fluid-filled, and 36° trainable. Plexiglass bow planes assist in controlling underway vertical motion.

**TRIM:** A mechanical control system within the pilot's compartment moves lead slugs fore or aft in trim tubes located in the battery compartment.

**POWER SOURCE:** Twenty 12-V, 67-amp-hr, 20-hr-rated, lead-acid batteries in separate water-tight compartment with nitrogen atmosphere and provisions for purging. Power available to customer: 120 VDC, 100 amp; 12 VDC, 2 amp. Additional 4-amp inverter available.

**LIFE SUPPORT:** Three blowers supply air through three 4-lb beds of Baralyme with 36 lb carried in reserve for 52 hr of life support for three men. Increasing to three 6-lb beds of LiOH extends life support for three men to 60 hr. O<sub>2</sub> supply is 50-ft<sup>3</sup> bottles (ea.) at 2,000 psi carried externally. Reserve supply of chlorate candles can be made available to provide 50-man-hr support. Three emergency regulators operate off the air system.

**VIEWING:** Eight horizontal and one vertical viewports in conning tower, 13 forward and 4 aft in pressure hull. Thickness of 1.5 in.; ID of 6.3 in., OD of 8.0 in.

**OPERATING/SCIENTIFIC EQUIPMENT:** Magnesyn and gyrocompass, automatic pilot, depth gage and depth recorder, UOC, current meter, water temperature sensor, altimeter.

**MANIPULATORS:** None.

**SAFETY FEATURES:** Can surface by blowing main ballast tanks or buoyancy control tanks at operating depth. Droppable keel; inflatable bag can be filled with CO<sub>2</sub> or gas generator. Cockpit may be flooded for egress. Three emergency breathing regulators are connected with vehicles' low pressure air system.

**SURFACE SUPPORT:** SOO.

**OWNER:** Sub Sea Oil Services (S.P.A.), Milan, Italy.

**BUILDER:** Perry Submarine Builders, Riviera Beach, Florida.

**REMARKS:** Presently undergoing refurbishment.



PC-8B

LENGTH: ..... 18.5 ft  
BEAM: ..... 5.75 ft  
HEIGHT: ..... 6.75 ft  
DRAFT: ..... 5 ft  
WEIGHT (DRY): ..... 5.5 tons  
OPERATING DEPTH: ..... 800 ft  
COLLAPSE DEPTH: ..... 1,800 ft  
LAUNCH DATE: ..... 1971

HATCH DIAMETER: ..... 24 in.  
LIFE SUPPORT (MAX): ..... 48 man-hr  
TOTAL POWER: ..... 22 kWh  
SPEED (KNOTS): CRUISE ..... 2/8 hr  
MAX ..... 4/2 hr  
CREW: PILOTS ..... 1  
OBSERVERS ..... 1  
PAYLOAD: ..... 500 lb

**PRESSURE HULL:** Cylinder with hemispherical bow and conical aft section composed of low temperature carbon steel 3.5-ft diam., 13.7-ft length, and 3/8 in. thick.

**BALLAST/BUOYANCY:** Two main free-flooding ballast tanks straddle the pressure hull and are blown with compressed air. One variable ballast tank (160-lb capacity) in the pressure hull is free-flooding and pumped dry.

**PROPULSION/CONTROL:** All propulsion is provided by a stern-mounted, reversible propeller which is driven by a 7.5-hp, DC motor within the pressure hull. Electro-hydraulic rudder and dive plane.

**TRIM:** No system provided.

**POWER SOURCE:** Lead-acid batteries are carried within two pressure-resistant pods beneath the hull and provide 24 and 120 VDC.

**LIFE SUPPORT:** O<sub>2</sub> flasks are carried externally (four ea. of 72-ft<sup>3</sup> cap., 2,250 psi). CO<sub>2</sub> is removed by LiOH. Monitors for O<sub>2</sub> and CO<sub>2</sub>, altimeter. Emergency breathing provided by two scuba regulators drawing off the compressed air for deballasting.

**VIEWING:** Plastic bow dome, 2.25 in. thick (114° spherical segment). Eight (8-in. OD, 6¼-in. ID, 2-in.-thick) viewports in conning tower and one of the same dimensions in the hatch.

**OPERATING/SCIENTIFIC EQUIPMENT:** UQC, CB radio, scanning sonar, compass, automatic pilot, depth gage.

**MANIPULATORS:** One with three degrees of freedom.

**SAFETY FEATURES:** Droppable weight (450 lb), MBT's can be blown at operating depth. Fire extinguisher. Life vests.

**SURFACE SUPPORT:** SOO.

**OWNER:** Northern Offshore Ltd., London.

**BUILDER:** Perry Submarine Builders, Riviera Beach, Fla.

**REMARKS:** Operating.

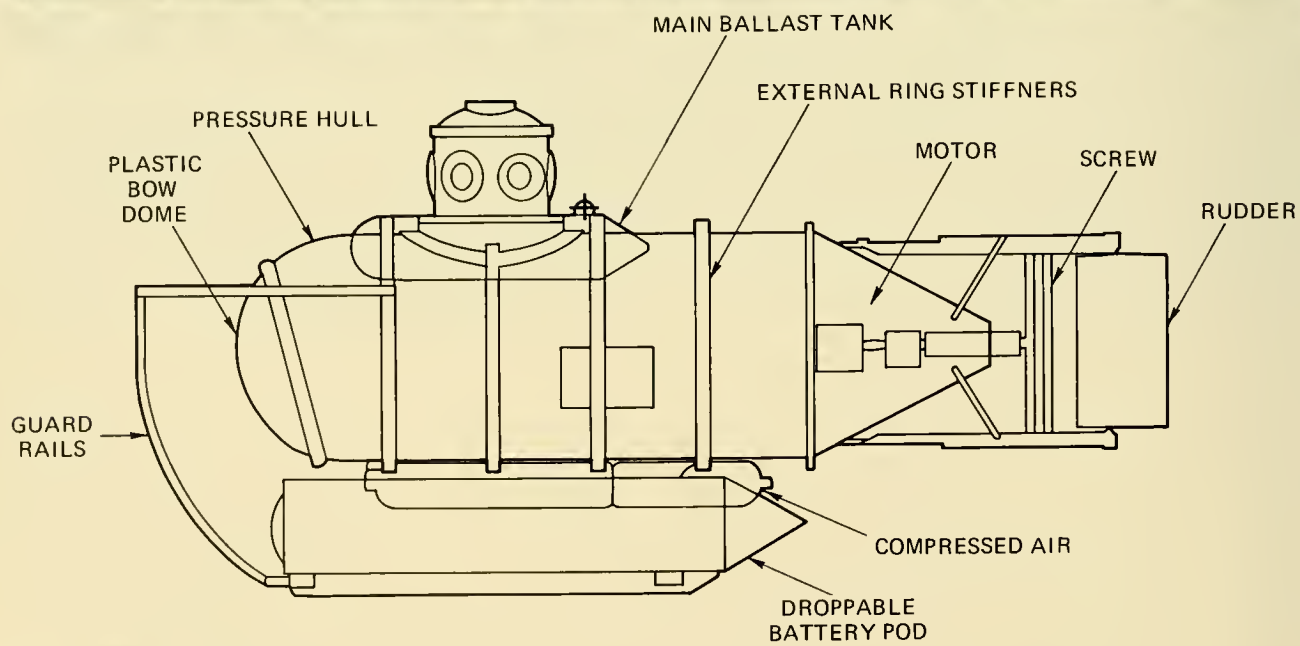
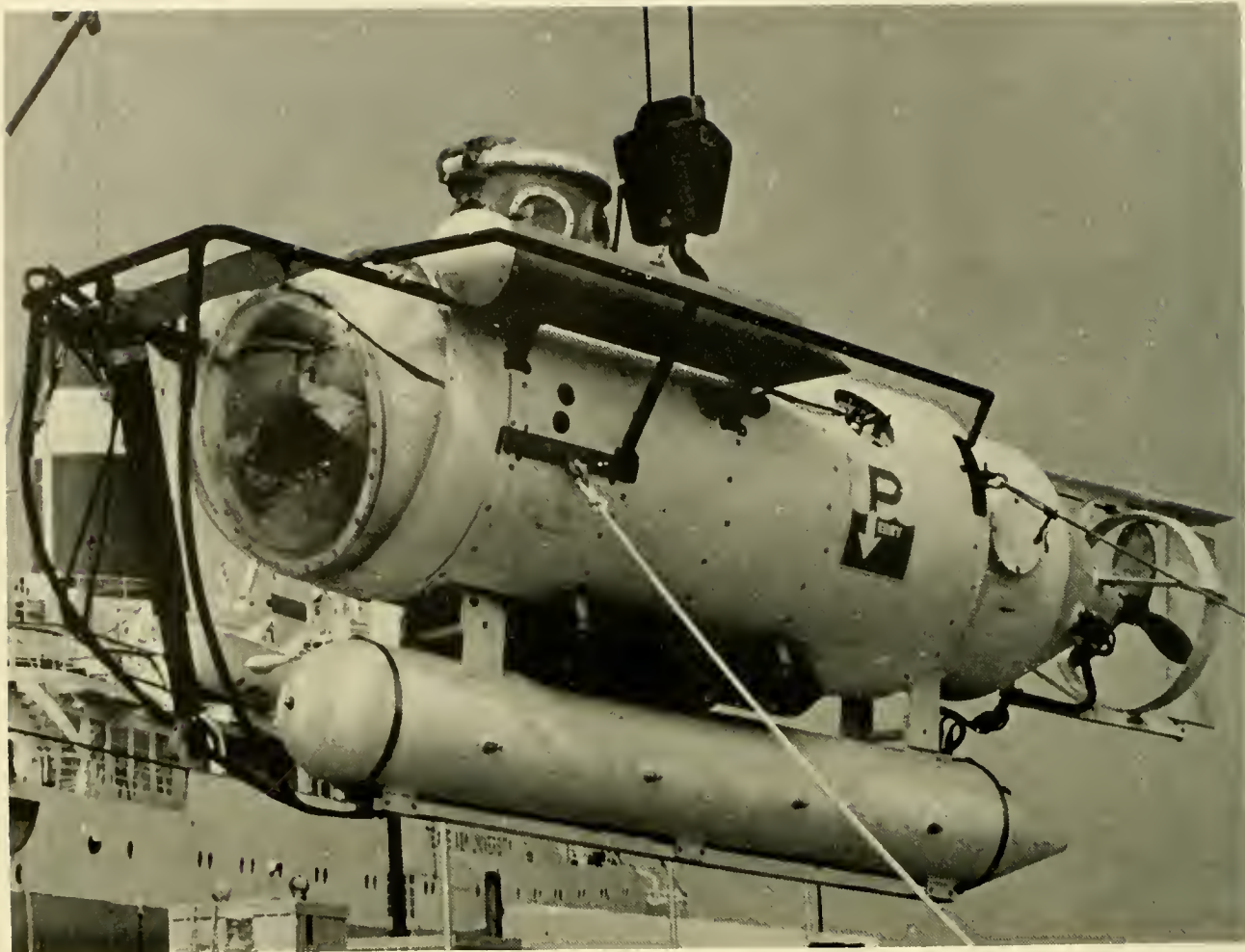

PC-14

LENGTH: ..... 19.5 ft  
BEAM: ..... 5 ft  
HEIGHT: ..... 8 ft  
DRAFT: ..... 6 ft  
WEIGHT (DRY): ..... 5 tons  
OPERATING DEPTH: ..... 1,200 ft  
COLLAPSE DEPTH: ..... NA  
LAUNCH DATE: ..... 1974

HATCH DIAMETER: ..... 19 in.  
LIFE SUPPORT (MAX): ..... 60 man-hr  
TOTAL POWER: ..... 15 kWh  
SPEED (KNOTS): CRUISE ..... NA  
MAX ..... NA  
CREW: PILOTS ..... 1  
OBSERVERS ..... 1  
PAYLOAD: ..... 1,100 lb

**PRESSURE HULL:** Cylindrical shape with a conical aft section made of A516 grade 70 normalized steel <sup>7</sup>/<sub>16</sub> in. thick, Plastic bow dome 40-in. ID and 2 in. thick.

**BALLAST/BUOYANCY:** Two main ballast tanks straddle the hull, these have a capacity of 200 lb each and are blown dry. Variable ballast tanks to obtain neutral buoyancy submerged have a capacity of 100 lb.

**PROPULSION/CONTROL:** Main propulsion is from a stern-mounted propeller powered by a 36-VDC, 7.3-amp, G.E. motor in the hull which drives a 0.5-hp hydraulic motor to actuate the propeller. Propeller is reversible and has three speeds forward and reverse. Manually actuated dive planes and rudder.

**TRIM:** No systems provided.

**POWER SOURCE:** Within a droppable, pressure-resistant cylinder are twelve 12-V, lead-acid batteries which provide all electrical power.

**LIFE SUPPORT:** Four O<sub>2</sub> flasks within the hull. O<sub>2</sub> flow is controlled by a flow meter. CO<sub>2</sub> is removed by LiOH. Monitoring devices for O<sub>2</sub>, CO<sub>2</sub> and hull pressure.

**VIEWING:** Plastic bow dome forward. Six plastic viewports on conning tower sides and one in hatch cover of 7.5-in. OD and 6.5-in. ID.

**OPERATING/SCIENTIFIC EQUIPMENT:** UQC, directional gyro, CB radio, depth gage.

**MANIPULATORS:** One with four degrees of freedom.

**SAFETY FEATURES:** Main ballast tanks can be blown at operating depth. Battery pod droppable. Emergency breathing off compressed air. Life jackets.

**SURFACE SUPPORT:** Presently operating off the R/V GYRE.

**OWNER:** Texas A & M Univ., College Station, Texas.

**BUILDER:** Perry Submarine Builders, Riviera Beach, Fla.

**REMARKS:** Operational. Redesignated *DIAPHUS* by owner.

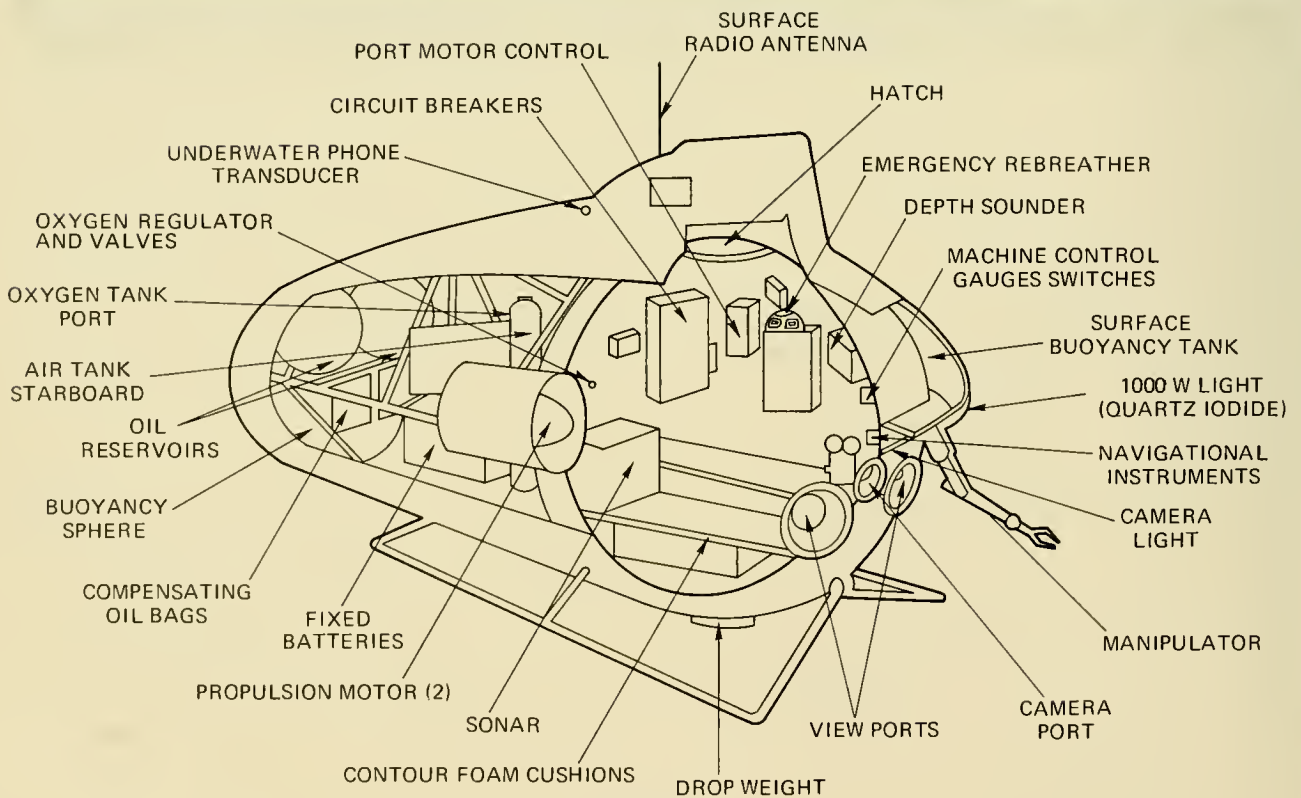
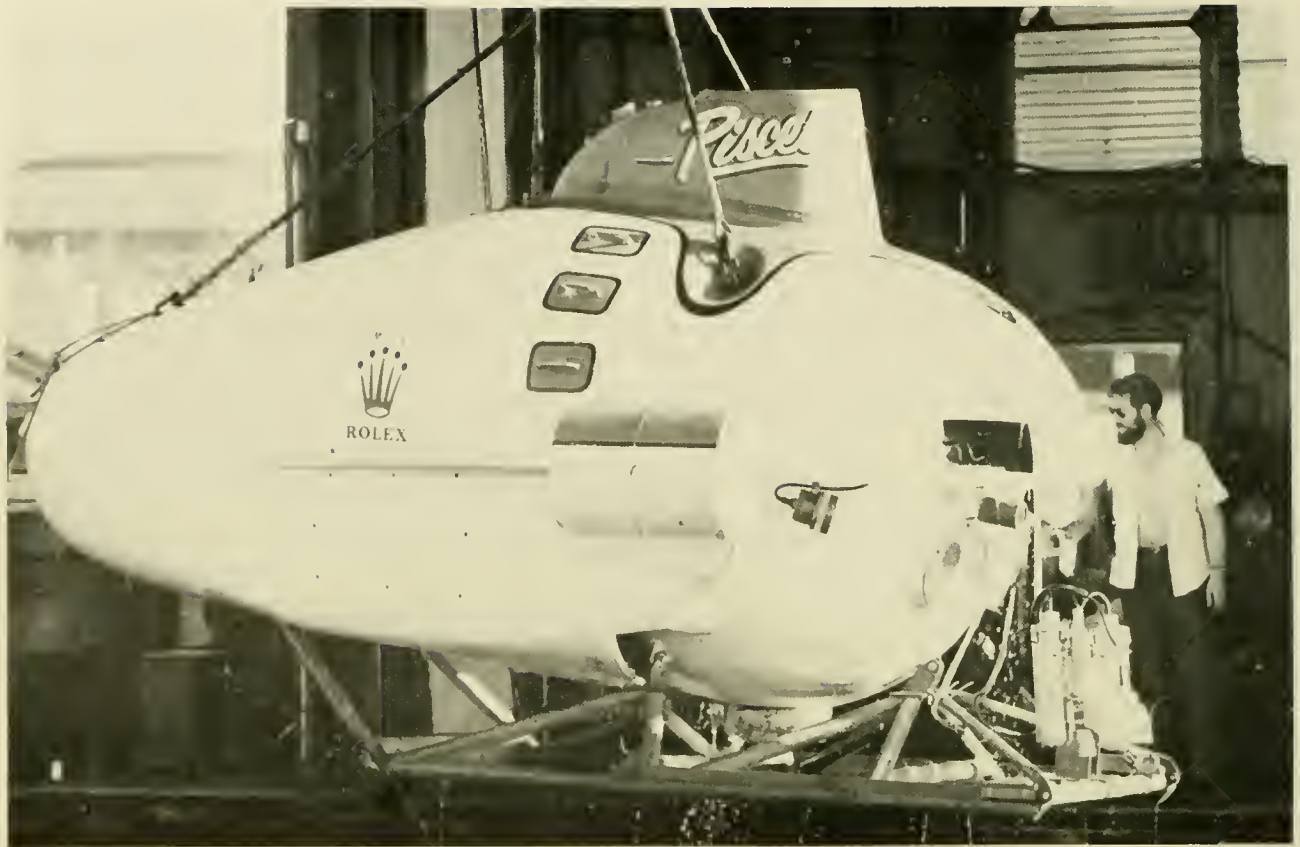

## PISCES I

LENGTH: ..... 16 ft  
BEAM: ..... 11 ft  
HEIGHT: ..... 10 ft  
DRAFT: ..... 7.5 ft  
WEIGHT (DRY): ..... 7.5 tons  
OPERATING DEPTH: ..... 1,200 ft  
COLLAPSE DEPTH: ..... 3,600 ft  
LAUNCH DATE: ..... 1965

HATCH DIAMETER: ..... 18 in.  
LIFE SUPPORT (MAX): ..... 100 man-hr  
TOTAL POWER: ..... 66 kWh  
SPEED (KNOTS): CRUISE ..... 1/8 hr  
MAX ..... 2/4 hr  
CREW: PILOTS ..... 1  
OBSERVERS ..... 1  
PAYLOAD: ..... 800 lb (Incl. crew)

**PRESSURE HULL:** Spherical shape (two hemispheres), of Algoma-44 steel, 0.75 in. thick and 6.5-ft OD.

**BALLAST/BUOYANCY:** Thirty gal of oil are carried in a hard aft sphere which can be electrically or manually pumped into flexible bladders at ambient pressure. Pumping oil into the bladders increases buoyancy at a rate of 64 lb for each ft<sup>3</sup> of water displaced. A total of 300 lb of positive buoyancy may be obtained with this system. On the surface high pressure air can blow clear a circular tank surrounding the upper half of the pressure hull and add a total of 2,000 lb of positive buoyancy to increase freeboard.

**PROPULSION/CONTROL:** Two 19-in. propellers mounted amidships on each side the vehicle provide forward or aft movement in the horizontal. The propellers are driven by two oil-filled, 5-hp, DC motors which can control screw rotation from 0 to 1,200 rpm in either direction.

**TRIM:** Up/down bow angles of  $\pm 15^\circ$  can be attained by moving the lower battery pod fore or aft by a hydraulic arm.

**POWER SOURCE:** Lead-acid battery pack (60 cells) in an oil-filled, pressure-compensated aluminum box rated at 500 amp-hr.

**LIFE SUPPORT:** O<sub>2</sub> supply is carried internally in a 50-ft<sup>3</sup> tank and is manually bled into the hull. CO<sub>2</sub> is removed by LiOH.

**VIEWING:** Three viewports looking forward and slightly downward of the horizontal. The two large ports are 6 in. thick, 6-in. ID, 13-in. OD providing approximately 48° of viewing each. A smaller viewport is located slightly above and between the two large ports for photography.

**OPERATING/SCIENTIFIC EQUIPMENT:** UQC (8-kHz), echo sounder, directional gyrocompass, TV, obstacle avoidance sonar, VHF radio, seawater temperature indicator, depth gage.

**MANIPULATORS:** One arm, six degrees of freedom, of 82-in. total reach and 150-lb lift. A second clamping arm is available which has three degrees of freedom, a jaw opening up to 21 in. and can rotate 360° at the wrist. Jaw clamp is capable of lifting or pulling 400 lb.

**SAFETY FEATURES:** O<sub>2</sub> rebreathers (two ea.). Mechanically jettisonable, 400-lb weight. Surface buoyancy system can be employed in an emergency while submerged. Mechanical arms jettisonable.

**SURFACE/SHORE SUPPORT:** VICKERS VOYAGER & VICKERS VENTURER.

**OWNER:** Vickers Oceanics, Barrow-in-Furness, England.

**BUILDER:** International Hydrodynamics Ltd., Vancouver, B.C.

**REMARKS:** Operational. The basic details, e.g., length, beam, height, etc., are taken from a recent brochure from the current owner; the remaining data was obtained primarily from the builder and may be incorrect as the vehicle now stands.

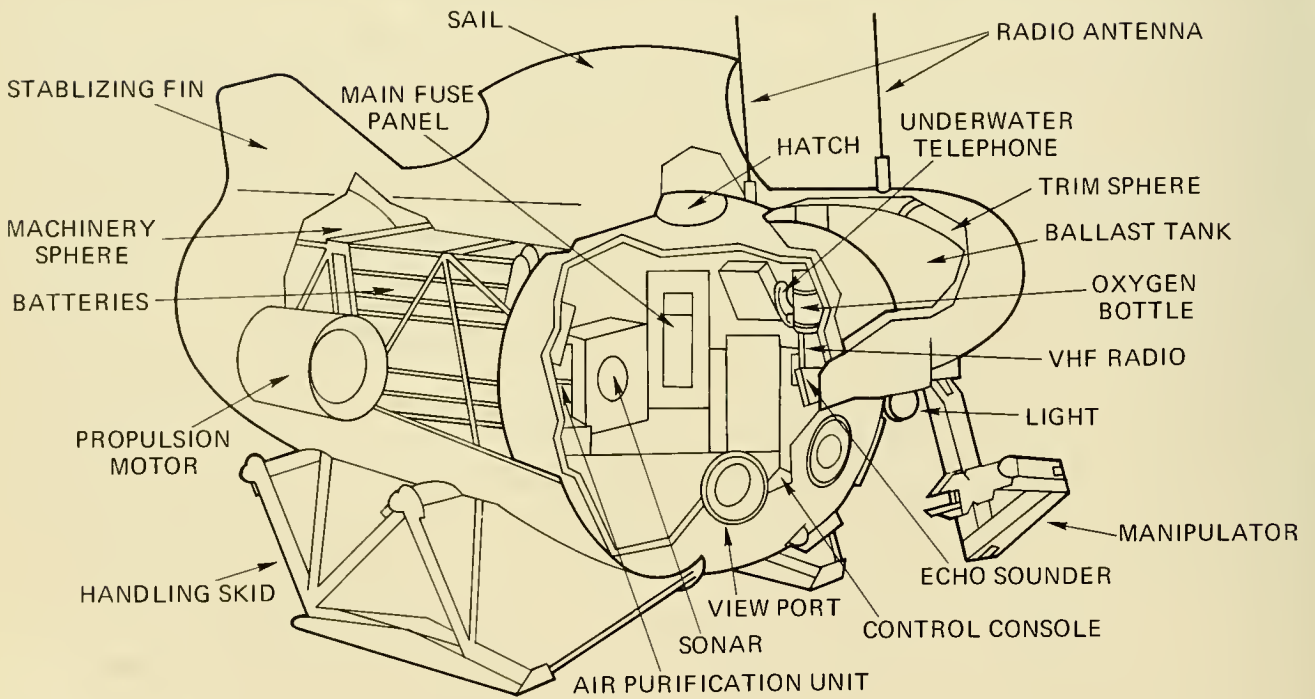



## PISCES II & III

LENGTH: ..... 20 ft  
BEAM: ..... 10 ft  
HEIGHT: ..... 10 ft  
DRAFT: ..... 7.5 ft  
WEIGHT (DRY): ..... 12.5 tons  
OPERATING DEPTH: PII: ..... 2,600 ft  
                  PIII: ..... 3,600 ft  
COLLAPSE DEPTH: ..... 5,000 ft  
LAUNCH DATE: PII: ..... 1968  
              PIII: ..... 1969

HATCH DIAMETER: ..... 19.5 in.  
LIFE SUPPORT (MAX): ..... 100 man-hr  
TOTAL POWER: ..... 40 kWh  
SPEED (KNOTS): CRUISE ..... NA  
                  MAX ..... 4  
CREW: PILOTS ..... 1  
          OBSERVERS ..... 2  
PAYLOAD: ..... 2,000 lb

**PRESSURE HULL:** Spherical shape, two hemispheres of A242 welded steel segments 1.1 in. thick; 6-ft 8-in. OD.

**OPERATING/SCIENTIFIC EQUIPMENT:** UQC, depth gage, echo sounder, directional gyro, transponder, TV, scanning sonar/interrogator, VHF radio.

**MANIPULATORS:** Two; one is for grasping (three degrees of freedom) and one for working (six degrees of freedom). Both can be adapted to carry drills, impact wrenches, grinders, mud pumps and cable cutters which can be changed underwater.

**SURFACE SUPPORT:** Both are supported by the M/V VICKERS VOYAGER (4,500-ton displacement) or the VICKERS VENTURER (640-ton displacement). The former is an ex-fish factory ship; the latter an ex-stern trawler.

**OWNER:** Vickers Oceanics Ltd., Barrow-in-Furness, England.

**BUILDER:** International Hydrodynamics Ltd., Vancouver, B.C.

**REMARKS:** The features given above are from the present owner, features not described parallel those of PISCES I when both PII & PIII were first constructed. Considerable modifications have taken place since the present owner acquired these vehicles.

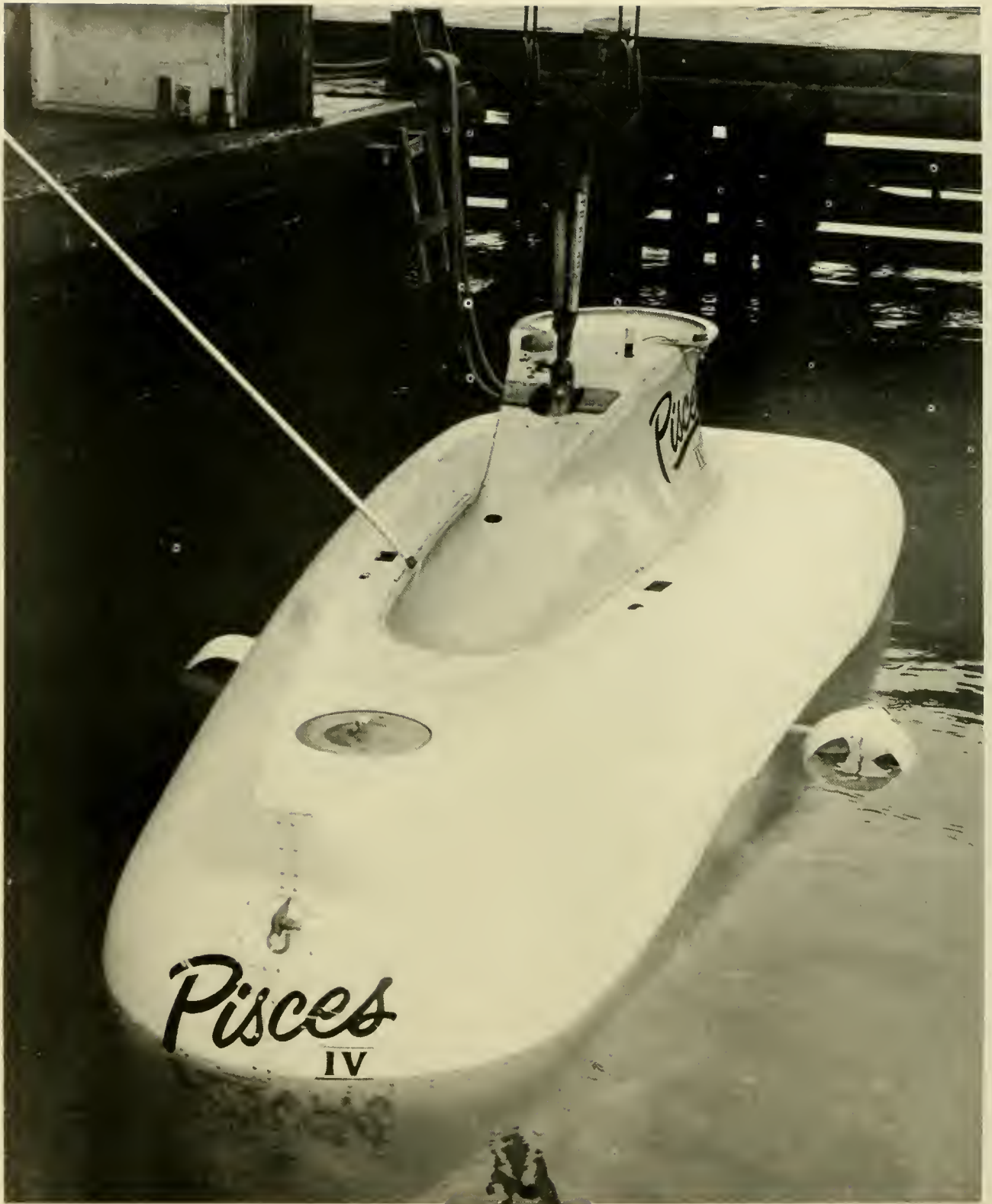

## PISCES IV & V

LENGTH: .....	20 ft	HATCH DIAMETER: .....	19.5 in.
BEAM: .....	10 ft	LIFE SUPPORT (MAX): .....	76 man-hr
HEIGHT: .....	12 ft	TOTAL POWER: .....	70 kWh
DRAFT: .....	8.75 ft	SPEED (KNOTS): CRUISE .....	2/6 hr
WEIGHT (DRY): .....	10 tons	MAX .....	4/3 hr
OPERATING DEPTH: .....	6,500 ft	CREW: PILOTS .....	1
COLLAPSE DEPTH: .....	9,750 ft	OBSERVERS .....	2
LAUNCH DATE: .....	1971, 1973	PAYLOAD: .....	1,500 lb (Incl. crew)

**PRESSURE HULL:** Spherical shape of HY-100 steel hemispheres 1.1 in. thick, 6-ft 8-in. OD.

**VIEWING:** On PISCES II, III, IV and V there are three viewports one looking directly forward, and two looking slightly port and starboard of the centerline a few degrees below the horizontal. All are 6-in. ID, 14-in. OD and 3.5 in. thick.

**OWNER:** PISCES IV: Canadian Department of Environment, Victoria, B.C.

PISCES V: P & O Intersubs, Vancouver, B.C.

**BUILDER:** International Hydrodynamics Ltd., Vancouver, B.C.

**REMARKS:** Operational, PISCES IV, V fall under the same constraints as the descriptions for PISCES II & III.

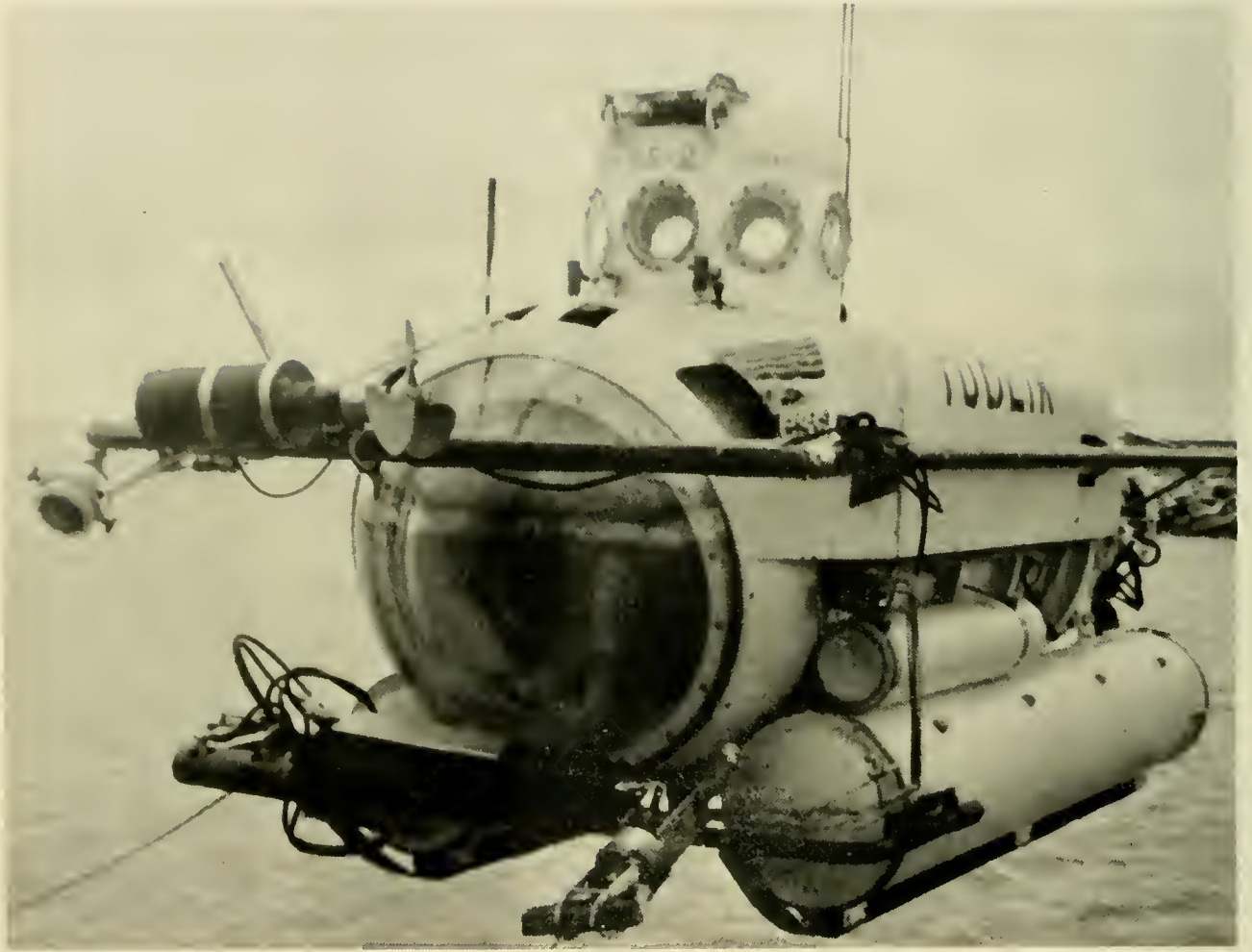

PS-2

LENGTH: ..... 18.5 ft  
BEAM: ..... 5.75 ft  
HEIGHT: ..... 6.75 ft  
DRAFT: ..... NA  
WEIGHT (DRY): ..... 6 tons  
OPERATING DEPTH: ..... 1,025 ft  
COLLAPSE DEPTH: ..... NA  
LAUNCH DATE: ..... 1972

HATCH DIAMETER: ..... NA  
LIFE SUPPORT: ..... 72 man-hr  
TOTAL POWER: ..... 17 kWh  
SPEED (KNOTS): CRUISE ..... NA  
MAX ..... NA  
CREW: PILOTS ..... 1  
OBSERVERS ..... 1  
PAYLOAD: ..... 1,000 lb

**PRESSURE HULL:** Cylindrical shape of ASTM A-516 grade 70 steel, 42-in. diam. and a 28-in. diam. conning tower.

**BALLAST/BUOYANCY:** Buoyancy is obtained through a soft tank which is pumped full to provide positive buoyancy or emptied to obtain negative buoyancy.

**PROPULSION/CONTROL:** Main propulsion is from a stern-mounted propeller driven by a variable-speed, reversible, DC, 7.5-hp, electric motor. Low speed maneuvering is provided by a thruster which can be mounted vertical or horizontal. Bow planes and a rudder are hydraulically controlled to provide underway attitude control.

**TRIM:** No systems provided.

**POWER SOURCE:** Two pressure-resistant battery pods carry lead-acid batteries providing 120-V main power and 24-V auxiliary power.

**LIFE SUPPORT:** NA.

**VIEWING:** Six, 6-in. diam. viewports in conning tower and one 6-in. diam. in hatch. One 116<sup>o</sup> hemispherical bow window similar to PC-8 provides wide angle viewing forward.

**OPERATING/SCIENTIFIC EQUIPMENT:** UQC, (27-kHz), directional gyro, CB radio, scanning sonar, pinger, transponder, surface light.

**MANIPULATORS:** One with four degrees of freedom.

**SAFETY FEATURES:** Ballast can be blown at maximum dive depth. Droppable weight of 200 lb, scuba apparatus for each passenger.

**SURFACE SUPPORT:** SOO.

**OWNER:** Sub Sea Oil Services, S.P.A., 45 Via San Vittore, 20123 Milano, Italy.

**BUILDER:** Perry Submarine Builders, Inc., Riviera Beach, Fla.

**REMARKS:** Operational, Also known as TUDLIK when operated by Access of Toronto, Canada.

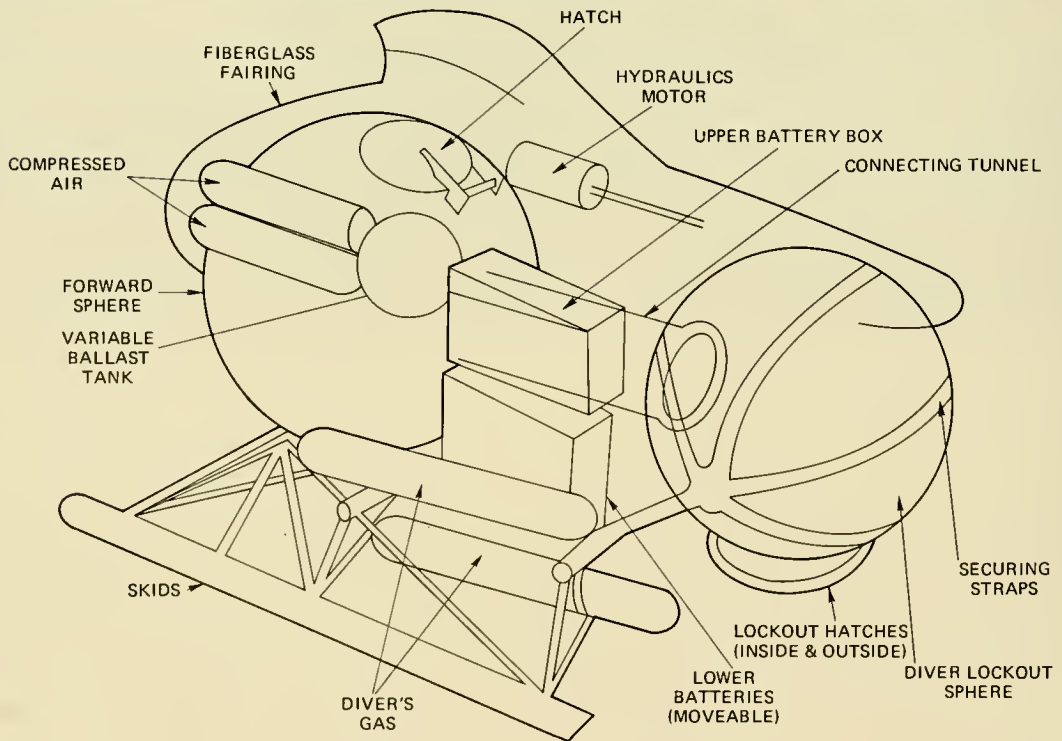
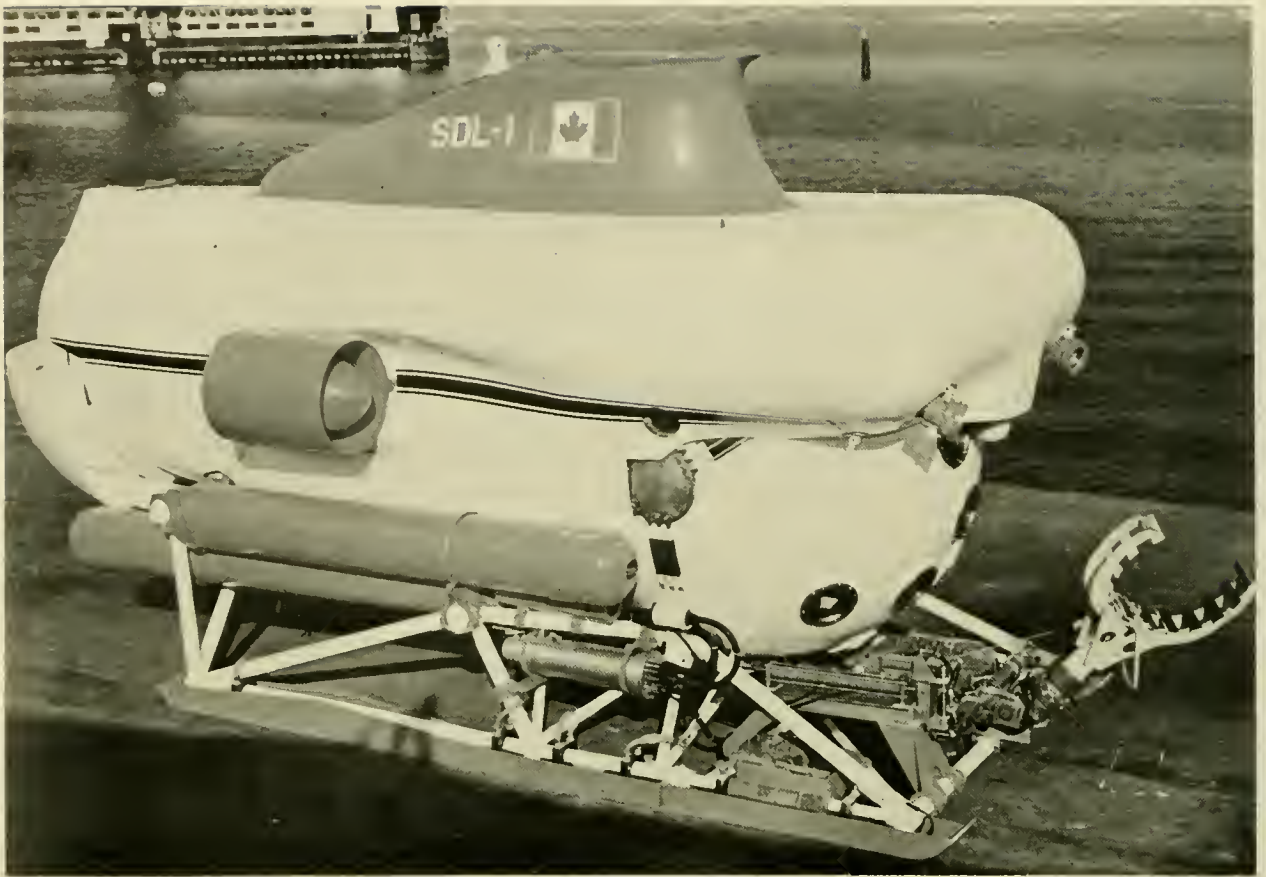



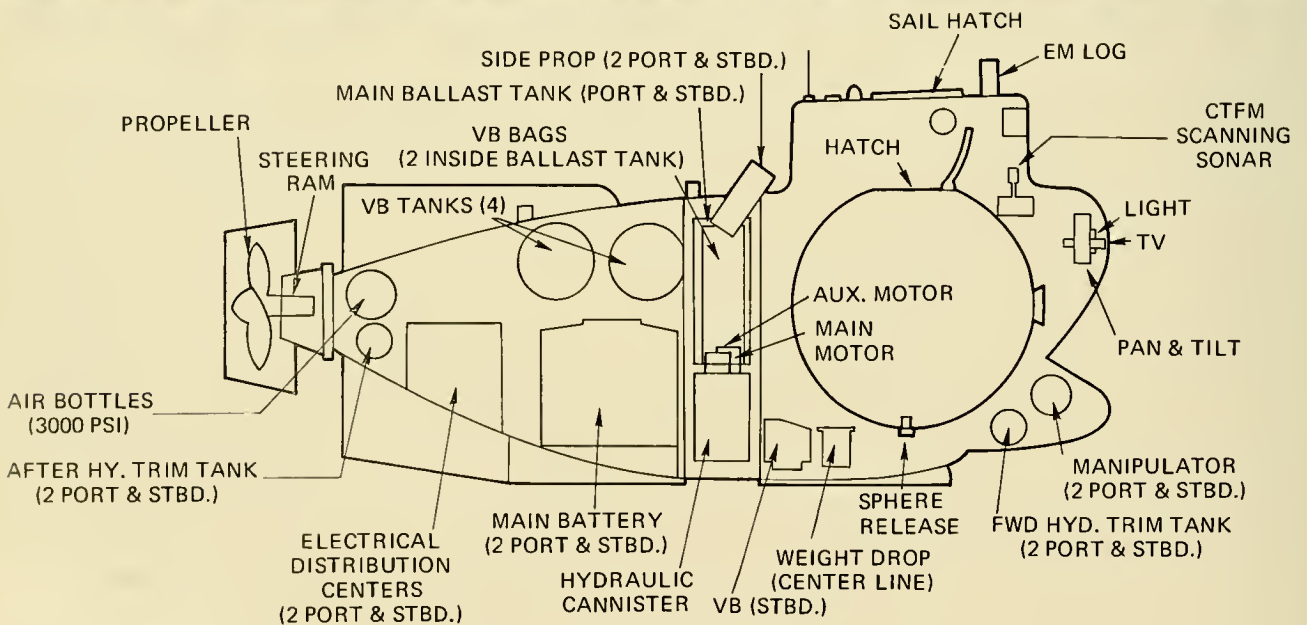
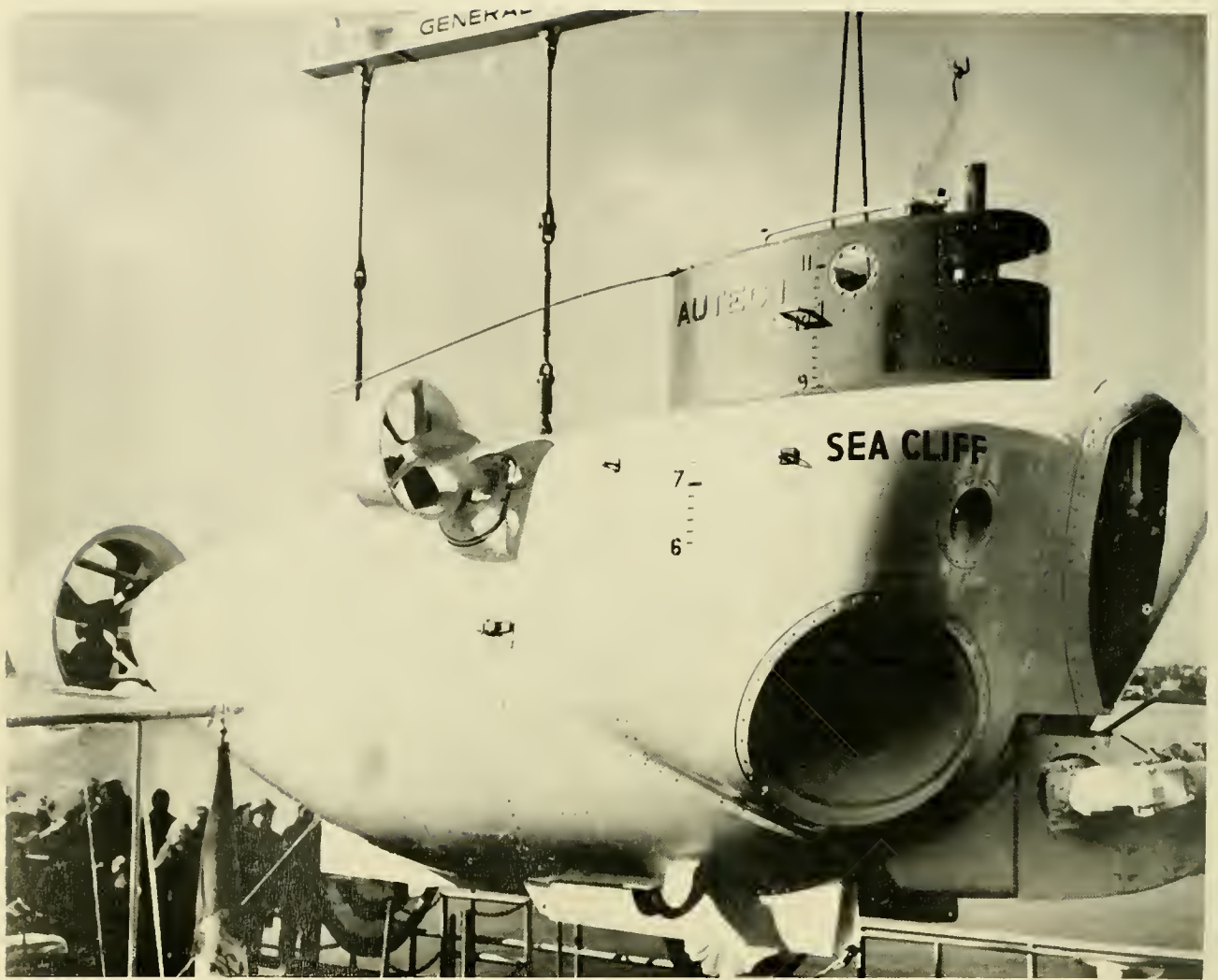



## SEA CLIFF & TURTLE

LENGTH: .....26 ft  
BEAM: .....12 ft  
HEIGHT: .....12 ft  
DRAFT: .....7.4 ft  
WEIGHT (DRY): .....24 tons  
OPERATING DEPTH: .....6,500 ft  
COLLAPSE DEPTH: .....9,750 ft  
LAUNCH DATE: .....1968

HATCH DIAMETER: .....19.75 in.  
LIFE SUPPORT (MAX): .....100 man-hr  
TOTAL POWER: .....60 kWh  
SPEED (KNOTS): CRUISE .....1/8 hr  
MAX .....2.5/1 hr  
CREW: PILOTS .....2  
OBSERVERS .....1  
PAYLOAD: .....300 lb

**PRESSURE HULL:** Spherical shape of 1.33-in.-thick, quenched and tempered HY-100 steel. Sphere is 7-ft OD of two welded hemispheres which thicken to 3.5 in. at viewports. Entire sphere stress-relieved.

**BALLAST/BUOYANCY:** The submersibles descend by flooding the two main ballast tanks and partially emptying the two variable ballast oil-filled bladders into the four variable ballast tanks. This variable ballast system is the primary ballast control for diving and surfacing. The variable ballast system can attain a buoyancy differential of 880 lb. The two main ballast tanks are used primarily to gain freeboard while on the surface.

**PROPULSION/CONTROL:** A single stern shroud and propeller and two side propulsion units are the principal propulsion systems. The stern propeller is powered by a variable-speed, hydraulic motor and can be trained through 45° left and right. The side pod propulsion units are powered by reversible, variable-speed, DC electric motors and can be trained together through 360° by an electric motor. The three motors and reduction gears are encased in a pressure-compensating oil environment and can be operated in three modes: stern propeller alone, side pods alone, side pods & stern propeller together.

**TRIM:** Up/down bow angles of ±25° are obtainable by transferring 540 lb mercury/oil fore or aft to three (two forward & one aft) small fiberglass spheres.

**POWER SOURCE:** Electrical power is supplied by two 60-V and two 30-V, pressure-compensated, lead-acid batteries. The 60-V batteries have a total capacity of 500 amp-hr at a 6-hr discharge rate; energy stored totals 30 kWh. The 30-V batteries also have a total capacity of 500 amp-hr at a 6-hr discharge rate; energy stored totals 15 kWh. Power is available as: 120 VAC, 60 Hz, single phase; 120 VAC, 400 Hz, single phase; 60 VDC; 30 VDC; 24 VAC, 40 Hz, three phase (fed directly to gyrocompass). Two 30-V, silver-zinc safety batteries located within the personnel sphere have a total capacity of 12 amp-hr at a 1-hr discharge rate.

**LIFE SUPPORT:** O<sub>2</sub> is carried in a 0.6-ft<sup>3</sup> tank at 3,000 psi. LiOH is used to remove CO<sub>2</sub> by air blown through cannisters at 7 SCFM.

**VIEWING:** There are five viewports, four in the sphere and one in the hatch. The four main viewports are oriented one dead ahead, two (one each side) on the port and starboard quadrant at an approximate 40° declination and one on centerline looking downward at approximately 80° from the horizontal. The main ports are 3.5 in. thick with an ID of 5 in. and an OD of 12 in. The fifth smaller port is located in the center of the hatch and is used for obstacle avoidance and ambient light observations, it is 2 in. thick, has an ID of 2-1/8 in., and an OD of 6 in., and a 45° angle of view.

**OPERATING/SCIENTIFIC EQUIPMENT:** UQC (8.087-kHz) Two closed-circuit TV cameras (one mounted on pan & tilt mechanism the other on starboard manipulator), gyrocompass, depth indicator, altimeter, speedometer, odometer, CTFM sonar, electromagnetic log, inclinometer, echo sounder.

**MANIPULATORS:** Each submersible is equipped with two identical manipulators. Each manipulator can be equipped with tools to perform varied tasks such as drilling, cable cutting, and grasping of objects. These tools are stored in racks on the submersible and can be interchanged during a mission. Each manipulator is capable of seven degrees of freedom.

**SAFETY FEATURES:** Emergency breathing apparatus (3 man-hr). Manipulators jettisonable. The three banks of batteries weighing 3,400 lb can be dumped. Ultimately, the personnel sphere and buoyancy ring can be separated from the rest of the vehicle from within the sphere; its 1,800 lb of positive buoyancy will float the sphere to the surface. Emergency power in pressure hull.

**SURFACE SUPPORT:** Air (C5A), ship and truck/trailer transportable. Presently launched/retrieved at sea aboard a leased offshore work boat of 164-ft length, 198.4 tons and equipped with a 100-ton-capacity non-articulated crane.

**OWNER:** U.S. Navy, Submarine Development Group-One, San Diego, Calif.

**BUILDER:** General Dynamics Corp., Groton, Conn.

**REMARKS:** Both operational. These vehicles were originally designated AUTECH I & II. The Navy's numbered designation is DSV-3 (TURTLE) and DSV-4 (SEA CLIFF).

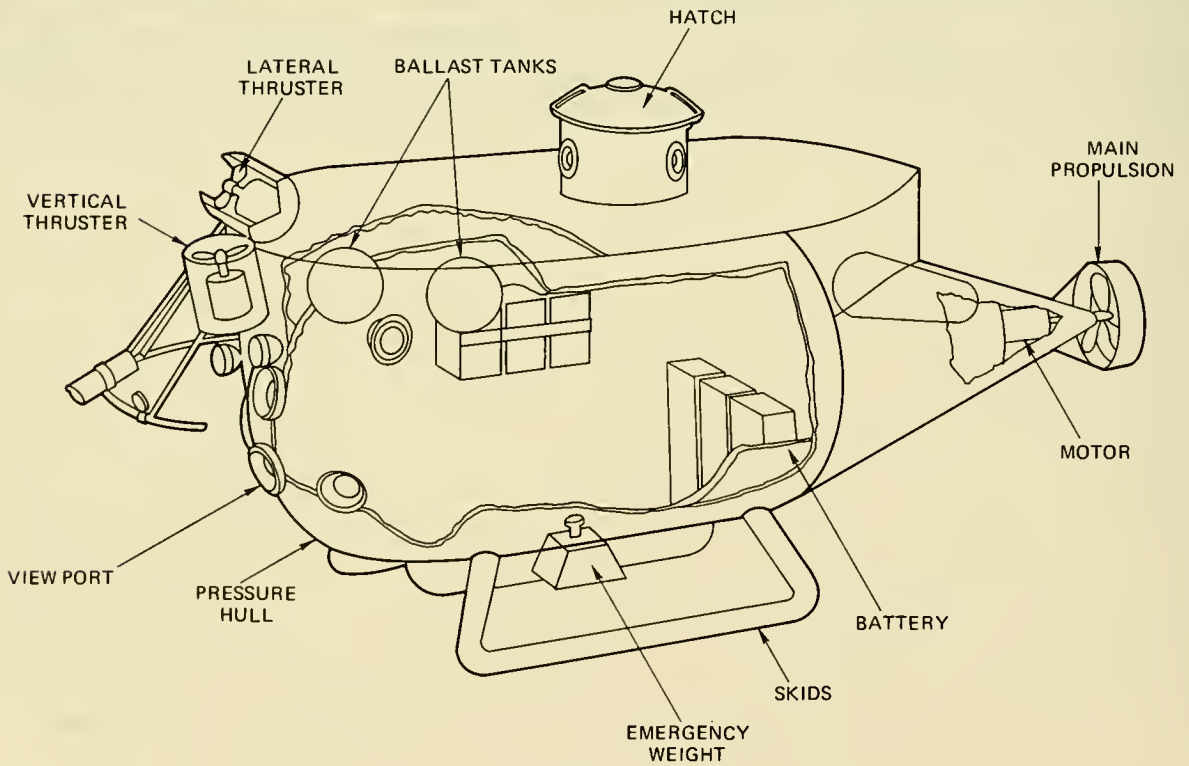

## SEA OTTER

LENGTH: ..... 13.5 ft  
BEAM: ..... 5 ft  
HEIGHT: ..... 7.2 ft  
DRAFT: ..... 5.5 ft  
WEIGHT (DRY): ..... 3.2 tons  
OPERATING DEPTH: ..... 1,500 ft  
COLLAPSE DEPTH: ..... 3,650 ft  
LAUNCH DATE: ..... 1971

HATCH DIAMETER: ..... 19 in.  
LIFE SUPPORT (MAX): ..... 192 man-hr  
TOTAL POWER: ..... 13.8 kWh  
SPEED (KNOTS): CRUISE ..... 1/6, hr  
MAX ..... 3/1.5 hr  
CREW: PILOTS ..... 1  
OBSERVERS ..... 2  
PAYLOAD: ..... .550 lb

**PRESSURE HULL:** Two 0.625-in.-thick, section welded, mild steel, hemispheric sections are welded to the ends of a 0.75-in.-thick, 57.0-in.-long, 48.0-in.-wide, mild steel cylinder, with a 0.75-in.-thick, 19.0-in.-diam., hatch tower welded in with double plates to the pressure hull.

**BALLAST/BUOYANCY:** Launched positively buoyant. Buoyancy is controlled by two 250-lb main buoyancy air/water ballast tanks and two 62.5-lb forward trim air/water ballast tanks. The tanks are alternately flooded and vented for descent, ascent and trim as required. Venting air is supplied by a 500-ft<sup>3</sup>, 3,000-psi air flask.

**PROPULSION/CONTROL:** A 3-hp, DC motor drives a 9-in. by 15-in. propeller for main propulsion. Two ½-hp, DC, horizontal thrusters located fore and aft provide steering along with a hydraulically controlled rudder (mounted on the main thruster) which serves as a trim tab for use in cross currents. A ½-hp vertical thruster is mounted forward. All thruster and main propulsion motors are air compensated. A Kort nozzle surrounds the stern propeller.

**TRIM:** Bow angle and fine trim are controlled by high pressure (3,000-psi) air and water in either the main or forward ballast tanks.

**POWER SOURCE:** Twelve 2-V lead-acid batteries provide 13.8 kWh. They are located inside the pressure hull and are equipped with catalyzers to eliminate H<sub>2</sub>.

**LIFE SUPPORT:** Three 40-ft<sup>3</sup> tanks of medical grade O<sub>2</sub> supply the life support system. Scrubbing of CO<sub>2</sub> is accomplished by recirculating air through a 6.4-lb LiOH cannister. Three cannisters provide 192 man-hr of available life support on each dive. CO<sub>2</sub> and O<sub>2</sub> percentages along with atmospheric pressure are monitored. A backup emergency breathing system (air supply through mouthpieces), is also provided off the high pressure air.

**VIEWING:** Four viewports are provided forward for the pilot and passengers, with two viewports along the side to accommodate reading externally-mounted instruments. Three viewports are located in the hatch tower, providing 270° of viewing and one viewport is located in the hatch, providing visibility toward the surface.

**OPERATING/SCIENTIFIC EQUIPMENT:** Two underwater telephone systems are provided (27-kHz primary, 42-kHz secondary). A directional gyrocompass and a narrow, horizontal bandwidth, 27-kHz receiving antenna are provided for navigation along with five air-compensated lights totaling 1.5 x 10<sup>6</sup> cp of illumination. Also provided are external depth and temperature gages, a pressure gage, a Hydro Products 400-exposure 70-mm camera and strobe, 16-mm cine camera with a capacity of 400 ft of film and a video camera with both audio and video recording capabilities. A 23-channel CB radio is provided for surface communication and direction finder location. A 27-kHz pinger for location, tracking and diver/submersible rendezvous operations and an upward/downward-looking echo sounder.

**MANIPULATOR:** The Beaver MKI Manipulator gives all the degrees of freedom of the human arm and hand plus 360° of rotation at the wrist and a wrist extension. Additional tools are available and can be provided on the manipulator for specific tasks. An "A" frame which is hydraulically controlled is also provided and is utilized as an attachment point for core samples, cable cutters, collection basket and many other simple tasks and applications as required.

**SAFETY FEATURES:** A 200-lb, mechanically-releasable, emergency ascent weight. A releasable buoy and messenger line that can be released by the pilot through a thru-hull penetrator. A magnesium release pin is used to provide release if the pilot is incapacitated. The messenger line is used to send down a self-locking clamp and lift line. The submersible can be retrieved even if flooded. Eight hours of emergency breathing air is also provided. Xenon light, life vests, fire extinguisher, distress rockets, CB radio, emergency food rations.

**SURFACE SUPPORT:** Can be transported by aircraft, ship, truck, or trailer. Submersible is normally on a trailer and can be launched from small boat launching ramp. Can be towed at 4-5 knots. Tows completely submerged.

**OPERATORS:** Arctic Marine, Ltd., North Vancouver, B.C., Canada.

**BUILDER:** Anautics Inc., San Diego, California.

**REMARKS:** Operational. This vehicle was originally PAULO I, it was purchased by Candive of Vancouver, B.C. and is now leased by the present operator.

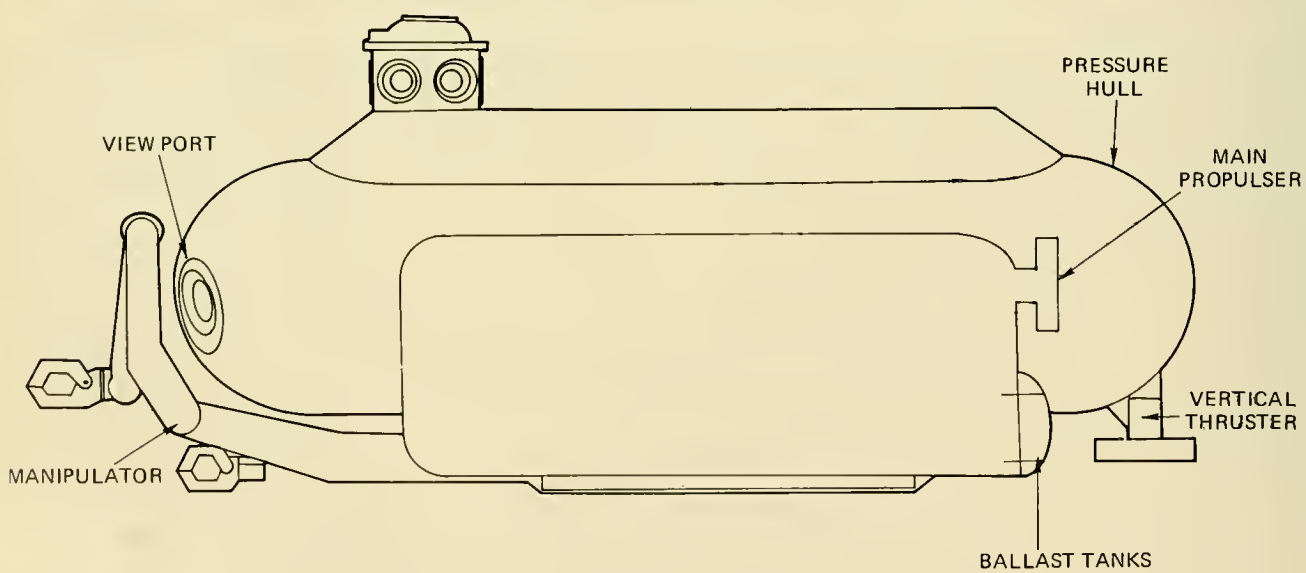
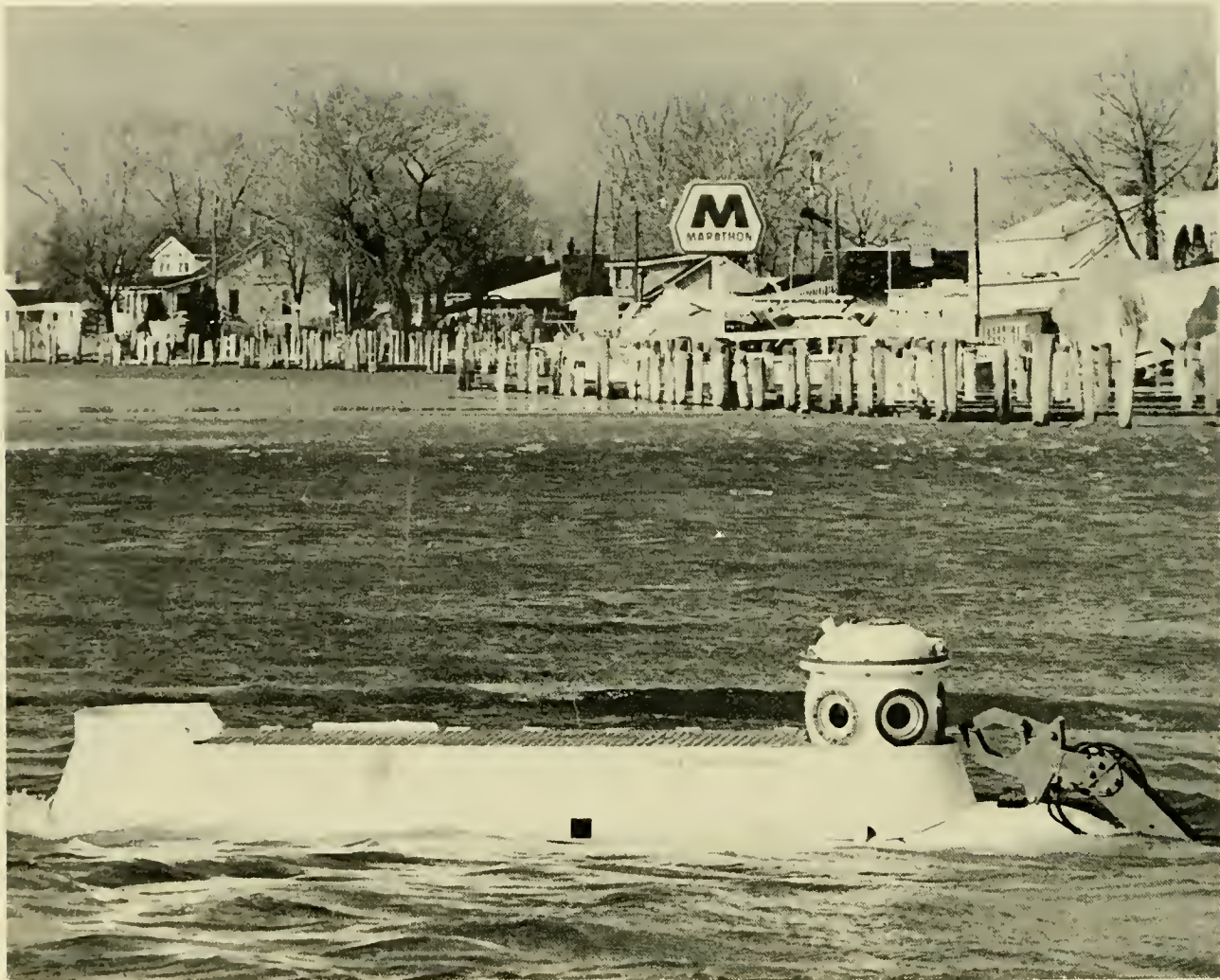

## SEA RANGER

LENGTH: .....17 ft  
BEAM: .....8 ft  
HEIGHT: .....7.75 ft  
DRAFT: .....NA  
WEIGHT (DRY): .....8 tons  
OPERATING DEPTH: .....600 ft  
COLLAPSE DEPTH: .....NA  
LAUNCH DATE: .....1972

HATCH DIAMETER: .....20 in.  
LIFE SUPPORT (MAX): .....120 man-hr  
TOTAL POWER: .....43.5 kWh  
SPEED (KNOTS): CRUISE .....NA  
                  MAX ......4  
CREW: PILOTS .....1  
      OBSERVERS .....3  
PAYLOAD: .....1.25 tons

**PRESSURE HULL:** Cylindrical shape with hemispherical endcaps; composed of 0.5-in.-thick A-285-C steel, 16 ft long and 4-ft diam. Conning tower is 2.25 ft high, 21-in. diam.

**BALLAST/BUOYANCY:** NA.

**PROPULSION/CONTROL:** Two stern-mounted (port-starboard) main propellers of 5.5 hp each. One stern-mounted 5.5-hp thruster provides movement in the vertical. A 10-hp electric motor in the pressure hull and hydraulic pump operate propellers and thruster.

**TRIM:** NA.

**POWER SOURCE:** Lead-acid batteries mounted externally in a pressure-resistant tank supply 240 V at 180 amp-hr. A cable can be fitted to the vehicle to supply surface-derived power if desired.

**LIFE SUPPORT:** NA.

**VIEWING:** Conning tower fitted with seven 7-in.-diam. plastic viewports, six circle the tower and one is in the hatch looking upward. Two 12-in.-diam. viewports are located in the forward hemihead (port/starboard) for forward and downward viewing.

**OPERATING/SCIENTIFIC EQUIPMENT:** Electronic compass, depth gage.

**MANIPULATORS:** Two manipulators. One is 6 ft long, has six degrees of freedom and can lift 200 lb at full extension. The second is a telescoping type with a clamping device to stabilize the submersible when necessary. The telescoping device is pivoted at the center of the vehicle and can drop vertically to provide 2,600 lb of lift.

**SAFETY FEATURES.** High pressure air can be blown into submersible to prevent flooding; 400-lb ballast is jettisonable; the entire undercarriage holding the propellers, manipulators, batteries and variable ballast tanks may be detached.

**SURFACE SUPPORT:** SOO.

**OWNER:** Verne Engineering, Mt. Clemens, Michigan.

**BUILDER:** Same as above.

**REMARKS:** Operating.

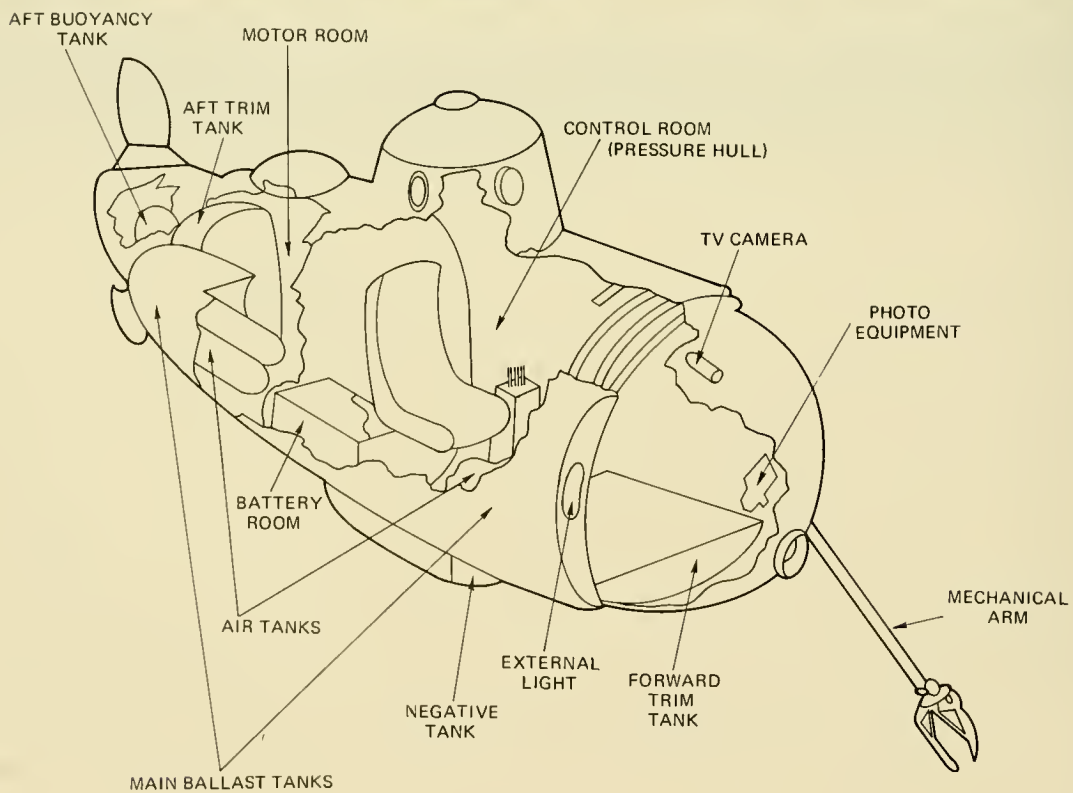
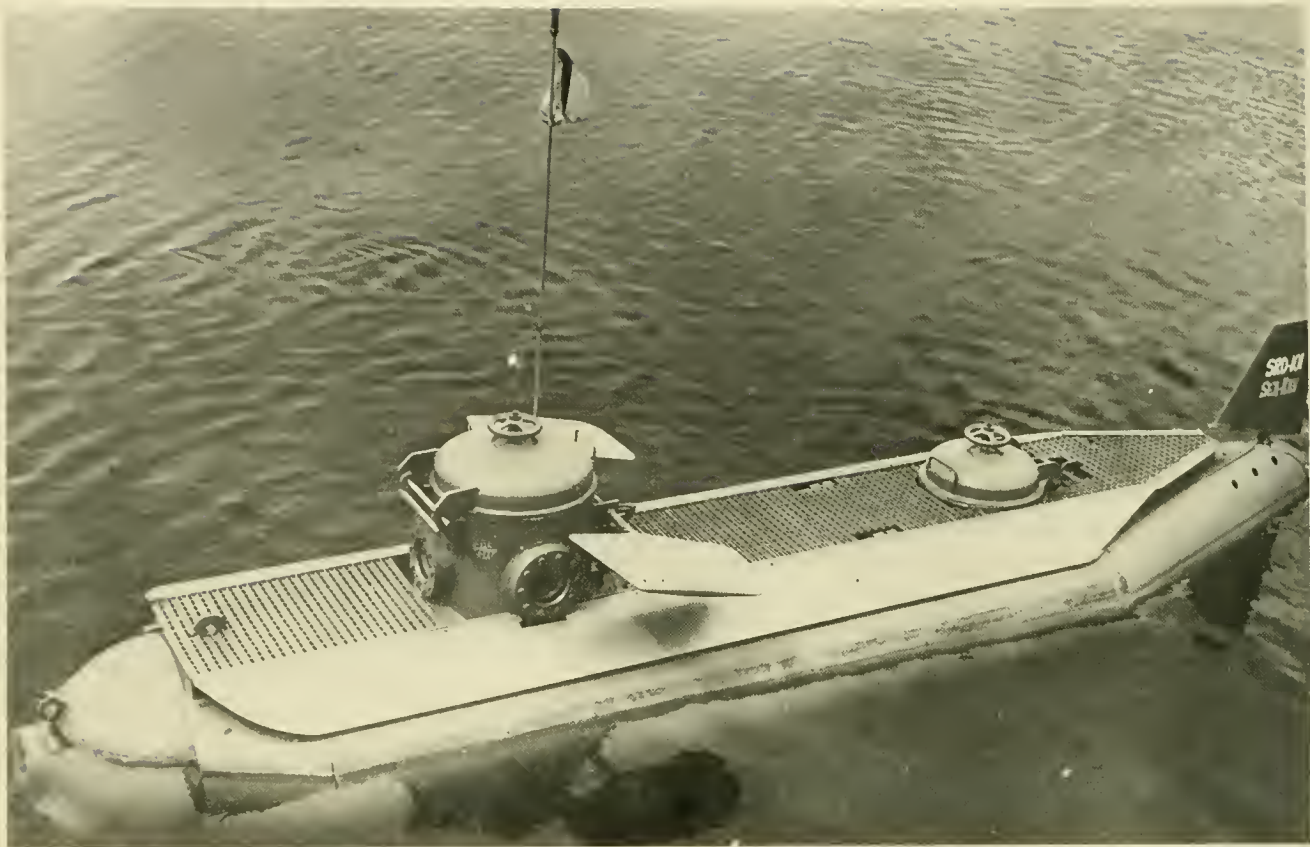

## SEA-RAY (SRD - 101)

LENGTH: ..... 20.5 ft  
BEAM: ..... 5 ft  
HEIGHT: ..... 5.5 ft  
DRAFT: ..... 3.25 ft  
WEIGHT (DRY): ..... 4.5 tons  
OPERATING DEPTH: ..... 1,000 ft  
COLLAPSE DEPTH ..... 5,000 ft  
LAUNCH DATE: ..... 1968

HATCH DIAMETER: ..... 23 in.  
LIFE SUPPORT (MAX): ..... 24 man-hr  
TOTAL POWER: ..... 15 kWh  
SPEED (KNOTS): CRUISE ..... 4/4 hr  
MAX ..... 6/2 hr  
CREW: PILOTS ..... 1  
OBSERVERS ..... 1  
PAYLOAD: ..... 400 lb

**PRESSURE HULL:** Cylindrical shape with hemispherical endcaps, 3-ft diam., 17 ft long, 0.5-in.-thick steel. An 18-in.-high, 2-ft diam. conning tower joins the hull.

**BALLAST/BUOYANCY:** Main ballast tanks for surface buoyancy. A separate tank which can be blown or pumped dry provides negative buoyancy to submerge.

**PROPULSION/CONTROL:** A reversible, 2-speed, stern-mounted propeller provides all propulsion and it is driven by a G.E., 5-hp, 900-rpm, 36-VDC motor. Rudder and dive planes are hydraulically-actuated.

**TRIM:** Up/down bow angles can be obtained by transferring seawater between a fore and an aft tank.

**POWER SOURCE:** Six, 12-V, 208-amp-hr, lead-acid batteries provide all power. The batteries are housed in a sealed compartment within the pressure hull.

**LIFE SUPPORT:** O<sub>2</sub> tank carried within the hull. CO<sub>2</sub> is removed by soda sorb. Monitors for O<sub>2</sub>, CO<sub>2</sub> and a H<sub>2</sub> detector. Silica gel carried to reduce humidity.

**VIEWING:** Eight viewports 1.75 in. thick and 6-in. diam. Four are in the conning tower and four are in the bow.

**OPERATING/SCIENTIFIC EQUIPMENT:** UQC, gyrocompass, two depth gages, still and cine cameras, TV.

**MANIPULATORS:** One.

**SAFETY FEATURES:** Hull may be pressurized with compressed air for underwater egress. External fitting for resupply of air underwater. Droppable keel. Negative tank can be blown or pumped dry at operating depth.

**SURFACE SUPPORT:** SOO.

**OWNER:** Submarine Research and Development Corp., Lynnwood, Washington.

**BUILDER:** Mr. E. Crosby, Edmonds, Washington.

**REMARKS:** Operating.

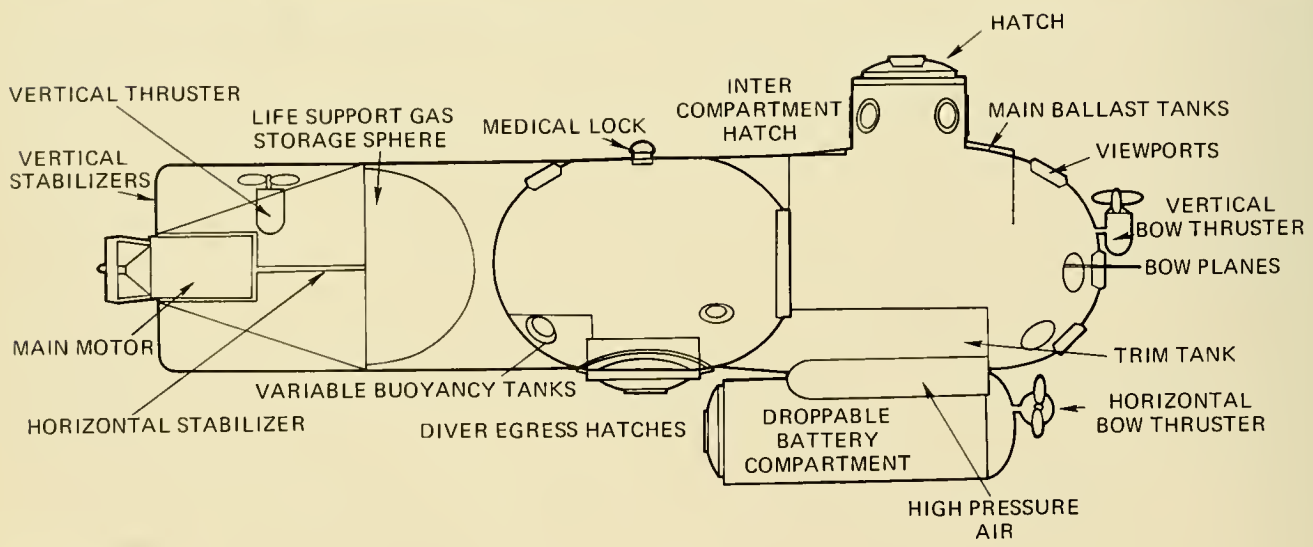
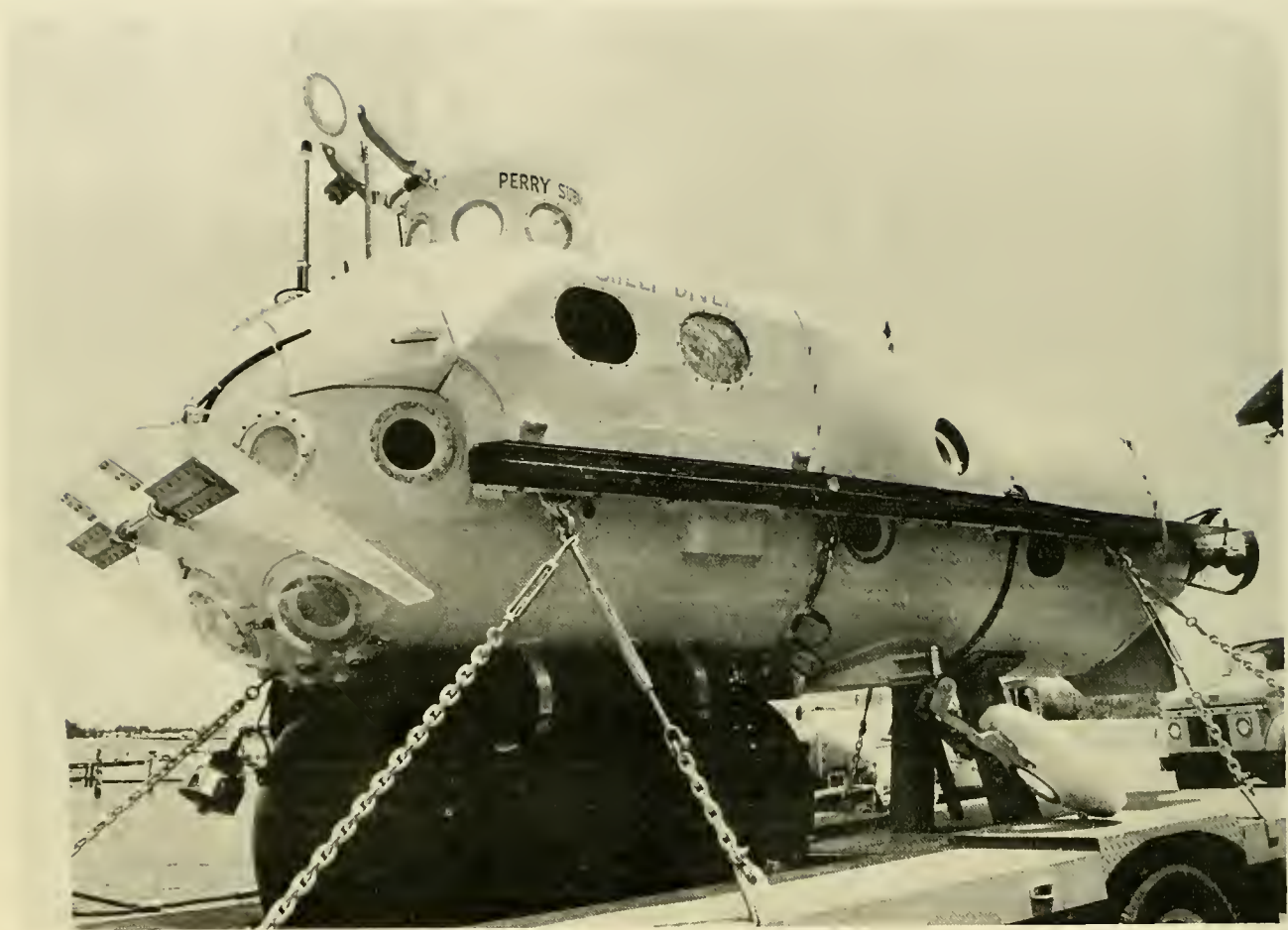



## SHELF DIVER (PLC4B)

LENGTH: ..... 23 ft  
BEAM: ..... 5.5 ft  
HEIGHT: ..... 9 ft  
DRAFT: ..... 6.7 ft  
WEIGHT (DRY): ..... 8.5 tons  
OPERATING DEPTH: ..... 800 ft  
COLLAPSE DEPTH: ..... 1,200 ft  
LAUNCH DATE: ..... 1968

HATCH DIAMETER: ..... 23 in.  
LIFE SUPPORT (MAX): ..... 172 man-hr  
TOTAL PDWER: ..... 37 kWh  
SPEED (KNOTS): CRUISE ..... 2/6 hr  
MAX ..... 3/0.5 hr  
CREW: PILOTS ..... 1  
OBSERVERS ..... 3  
PAYLOAD: ..... 1,400 lb

**PRESSURE HULL:** Consists of two cylindrical compartments 0.5 in thick with 54-in. diam., hemispherical endcaps. The hulls are A.S.M.E. SA-212 grade B firebox quality steel. The conning tower is made of the same steel but is 3/8 in. thick increasing to 0.5 in. at the interception with the hull. The conning tower is 28-in. OD and 19 in. high. Hatches are made of cast Almag 35. Gas sphere 0.5-in. HY-100 and HY-80 steel.

**BALLAST/BUOYANCY:** Two main ballast tanks, made of 11 gage mild steel, straddle the hull and provide 845 lb of positive buoyancy. Two externally-mounted high pressure air bottles of 440 ft<sup>3</sup> total capacity supply air at 2,250 psi to blow the main ballast tanks.

**PROPULSION/CONTROL:** Main horizontal propulsion is provided by a stern-mounted propeller driven by a 120-VDC, 1,150-rpm motor. Bow and stern thrusters are driven by a 2-hp, 120-VDC, 500-rpm motor. Bow dive planes assist in underway maneuvering. Additional assistance in steering is obtained from vertical and horizontal stern stabilizers.

**TRIM:** Consists of one fiberglass tank forward divided into two sections of 380-lb total capacity and a steel trim tank aft of 400-lb total capacity. A Hypro pump (6 gpm at 500 psi) driven by an electric motor can pump water from one trim tank to another and/or to and from the sea.

**POWER SOURCE:** Thirty-four V, lead-acid batteries of 95-amp-hr capacity each are located in an external battery pod. The batteries are at atmospheric pressure in the 0.5-in.-thick, 6.5-ft-long, 2.1-ft-diam., 1,200-lb pod. The pod is droppable in an emergency.

**LIFE SUPPORT:** CO<sub>2</sub> is absorbed by two 12-lb beds of Baralyme. Four externally-mounted bottles of O<sub>2</sub> supply a total of 338 ft<sup>3</sup> at 2,200 psi. Blowers circulate air in both compartments. Diver's gas mixture is supplied from a steel sphere of 33.5-ft<sup>3</sup> capacity at 2,000 psi. Emergency breathing from regulators in the vehicle is supplied from the high pressure air bottles used to blow the main ballast tanks.

**VIEWING:** Twenty-three viewports total, 15 double-acting in main hull, 8 single-acting in conning tower. Thickness of ports is 1.5 in., ID is 6 in., OD is 8 in.

**OPERATING/SCIENTIFIC EQUIPMENT:** UQC, Magnesyn compass, depth gages, echo sounder, radio, scanning sonar.

**MANIPULATORS:** None.

**SAFETY FEATURES:** The following systems can be blow free of water or jettisoned: ballast tank 845 lb, trim tanks 780 lb, battery pod (weight in water) 1,200 lb. Emergency batteries in hull.

**SURFACE SUPPORT:** The vehicle can be carried on a truck, ship or an aircraft. It can be towed to the dive site or carried aboard its 85-ft support boat.

**OWNER:** Operated by Inter-Sub, Marseilles, France.

**BUILDER:** Perry Submarine Builders, Riviera Beach, Florida.

**REMARKS:** Operational. Originally designated PLC4B.

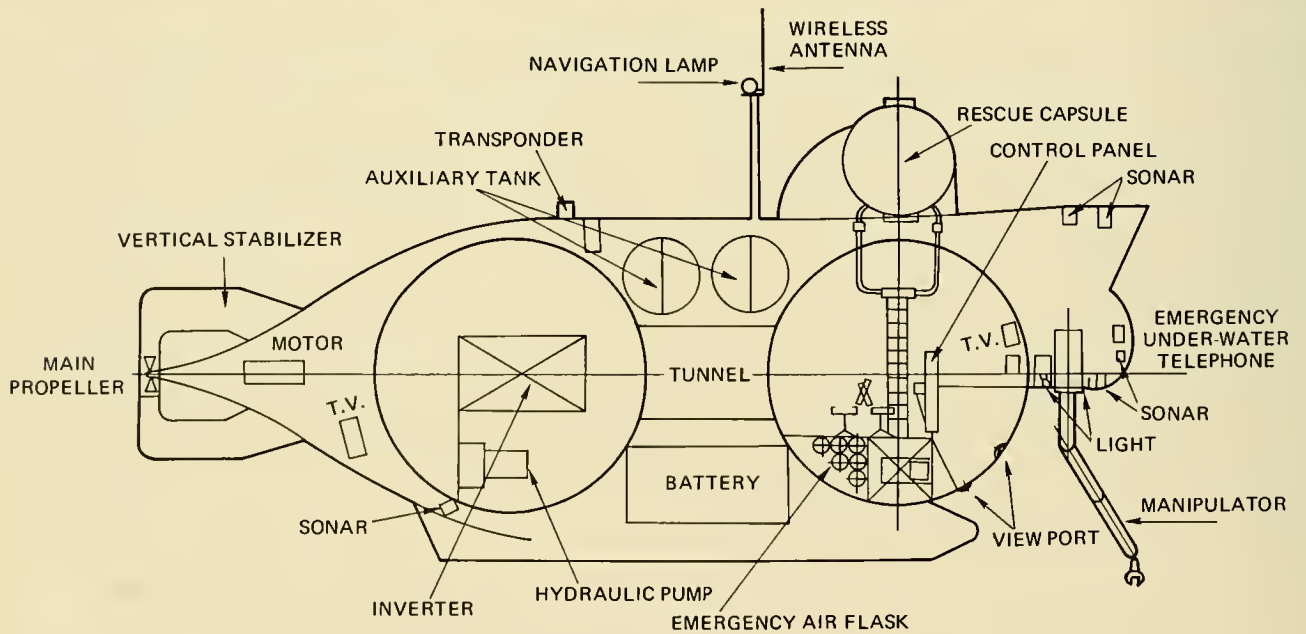



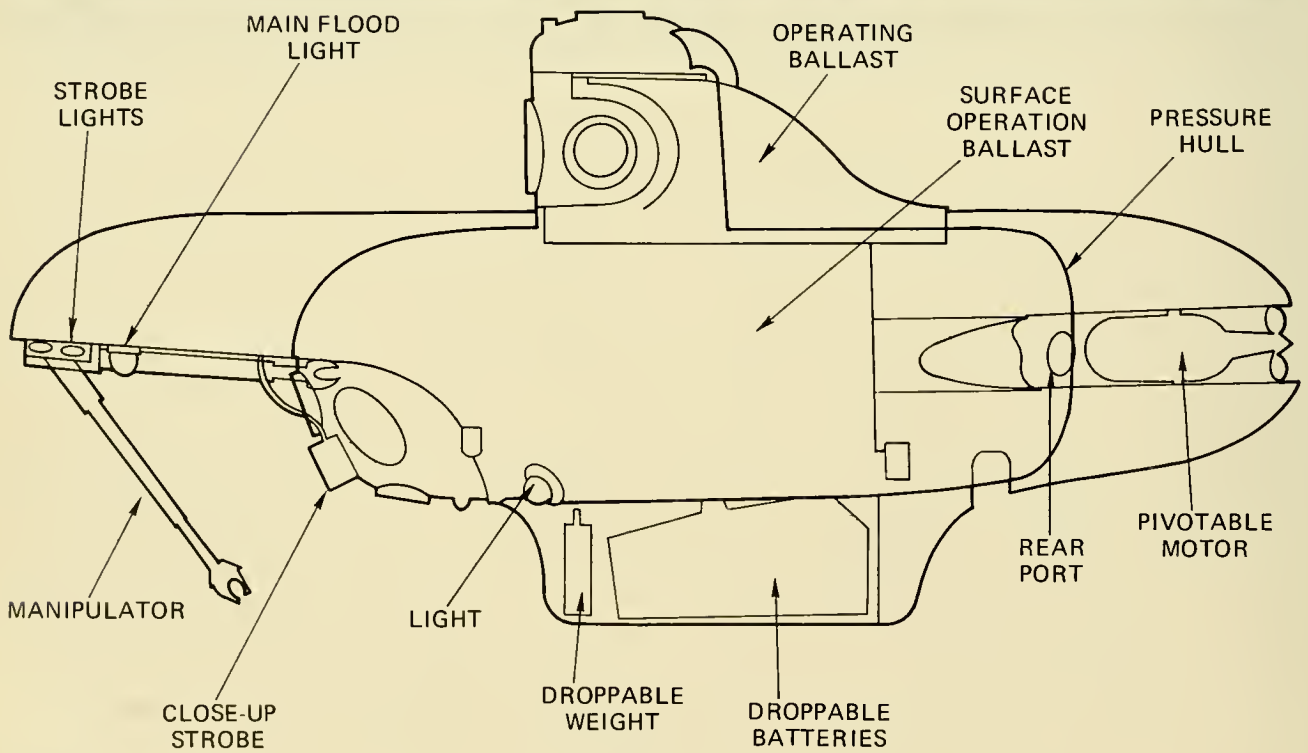

## SNOOPER

LENGTH: ..... 14.5 ft  
BEAM: ..... 4.1 ft  
HEIGHT: ..... 7 ft  
DRAFT: ..... 5 ft  
WEIGHT (DRY): ..... 2.25 tons  
OPERATING DEPTH: ..... 1,000 ft  
COLLAPSE DEPTH: ..... 2,100 ft  
LAUNCH DATE: ..... 1969

HATCH DIAMETER: ..... 24 in.  
LIFE SUPPORT (MAX): ..... 24 man-hr  
TOTAL POWER: ..... 9.7 kWh  
SPEED (KNOTS): CRUISE ..... 1/6 hr  
MAX ..... 3/4 hr  
CREW: PILOTS ..... 1  
OBSERVERS ..... 1  
PAYLOAD: ..... 200 lb

**PRESSURE HULL:** Cylindrical shape with hemispherical endcaps. Composed of mild steel (A-212) 0.5 in. thick and 36-in. OD on body and 24-in. OD on conning tower. Cylinder is approximately 8.3 ft long, conning tower is approximately 2.2 ft high.

**BALLAST/BUOYANCY:** At launch vehicle is positively buoyant and made negative by flooding a small volume tank located on conning tower fairing. A 12-ft<sup>3</sup> capacity tank provides additional freeboard when on the surface. Both tanks are free flooding and open to the sea at their lowest point at all times.

**PROPULSION/CONTROL:** One stern-mounted, reversible propeller driven by a 2-hp electric motor and capable of rotating 220° in the horizontal provides forward, reverse and lateral movement.

**TRIM:** No system included.

**POWER SOURCE:** Four 205-amp, 6-V, lead-acid, pressure-compensated batteries mounted under the pressure hull provide main propulsion power. All other power is supplied by two 100-amp, 24-V, nickel-cadmium batteries carried within the pressure sphere.

**LIFE SUPPORT:** O<sub>2</sub> is carried within the pressure hull and CO<sub>2</sub> is removed by blowing cabin air through a Baralyme cannister.

**VIEWING:** Ten acrylic plastic viewports all 2.5 in. thick. Two viewports are 12-in. OD, five are 10.5-in. ID and three are 8-in. ID.

**OPERATING/SCIENTIFIC EQUIPMENT:** UQC (8.072-kHz) range 6,000 yd. Two externally-mounted strobe lights for photography in addition to 12 flood lights of 250-W capacity each contained within four (three bulbs/dome) pressure-resistant pyrex domes. Vehicle was designed primarily for photography.

**MANIPULATORS:** One mounted forward of pressure sphere capable of two degrees of freedom and 8-lb lift.

**SAFETY FEATURES:** Hand-operated, hydraulically-releasable 140-lb weight. Mechanically-droppable battery pod (400 lb). Pressure hull is floodable to allow egress in the event of emergency.

**SURFACE SUPPORT:** SOO.

**OWNER:** Sea Graphics Inc., Torrance, California.

**BUILDER:** Sea Graphics Inc., Torrance, California.

**REMARKS:** Operational.

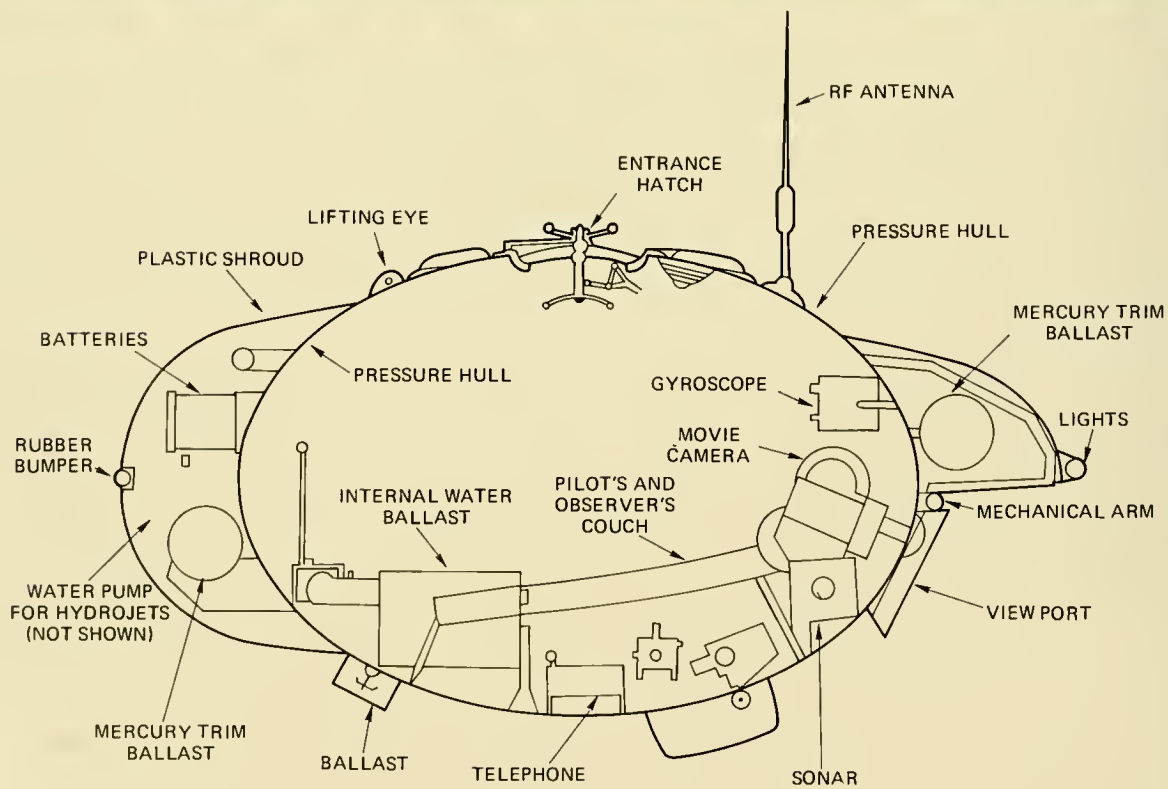
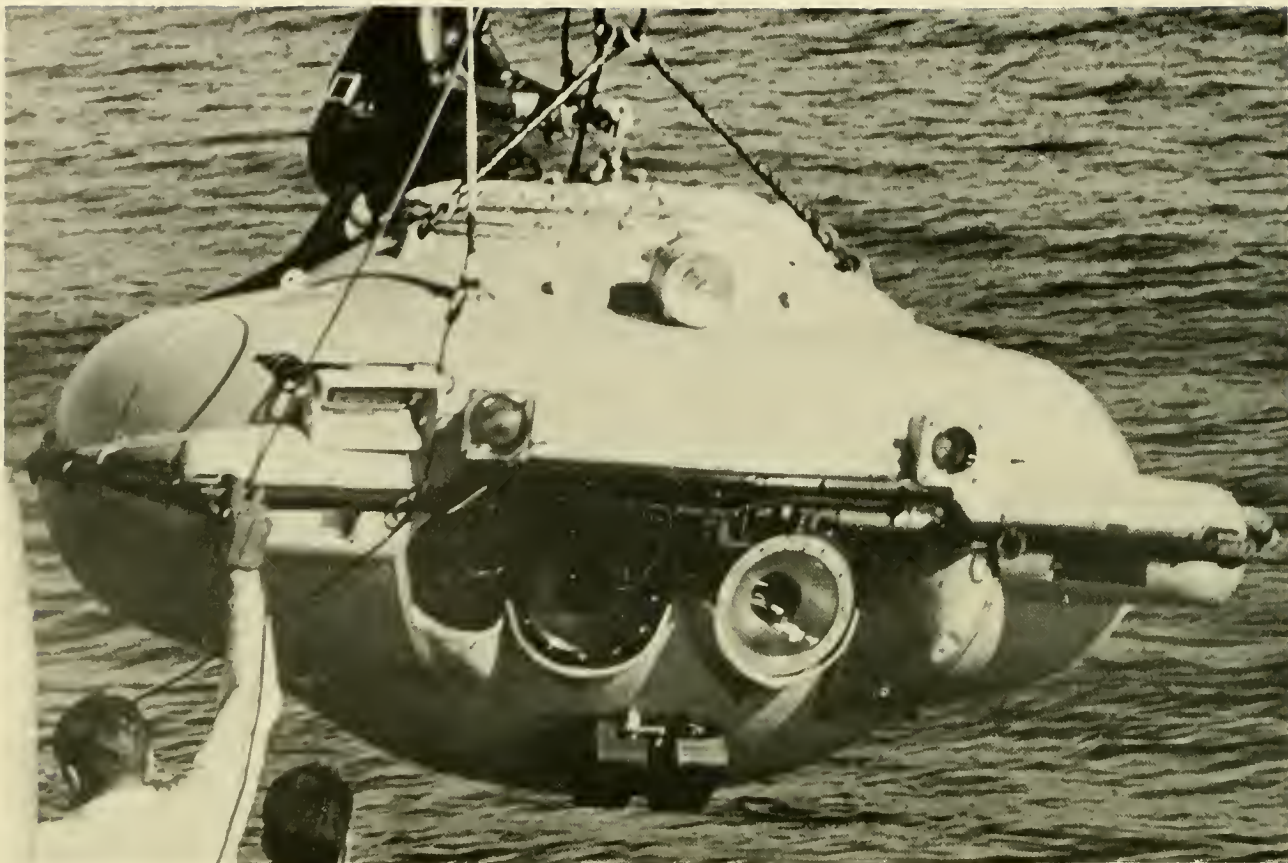

SP-350

LENGTH: ..... 9 ft  
 BEAM: ..... 9 ft  
 HEIGHT: ..... 5 ft  
 DRAFT: ..... 5 ft  
 WEIGHT (DRY) ..... 4.2 tons  
 OPERATING DEPTH ..... 1,350 ft  
 COLLAPSE DEPTH: ..... 3,300 ft  
 LAUNCH DATE: ..... 1959

HATCH DIAMETER: ..... 15.75 in.  
 LIFE SUPPORT (MAX): ..... 96 man-hr  
 TOTAL POWER: ..... 13 kWh  
 SPEED (KNOTS): CRUISE ..... 0.6/4 hr  
 MAX ..... 1.0/2 hr  
 CREW: PILOTS ..... 1  
 OBSERVERS ..... 1  
 PAYLOAD: ..... 300 lb

**PRESSURE HULL:** Two, 0.75-in.-thick, forged, mild steel ellipsoids are welded together to form a 6.5-ft major diam., 4.9-ft minor diam. pressure hull.

**BALLAST/BUOYANCY:** Launched negatively buoyant. Two 55-lb cast iron weights provide negative buoyancy at launch. When nearing the bottom one weight is mechanically dropped and the vehicle is near neutral buoyancy. Fine buoyancy control is obtained by flooding/pumping seawater in or out of a 12-gal tank. To ascend, the second 55-lb weight is dropped.

**PROPULSION/CONTROL:** A 2-hp, DC motor drives ambient seawater through a hard plastic, 2-in.-diameter tube configured to terminate on port and starboard sides at jet nozzles. Jets can be made to rotate 270° from straight forward (pointing aft) to the vertical. Water flow may be diverted from one jet to another. Motor speeds are ½ or full.

**TRIM:** Bow angles of ±30° from the horizontal are obtained by hydraulically pumping 275 lb of mercury from one to another of two cylinders located fore and aft of the vehicle. The forward cylinder is above the vehicle's centerline and the aft one below.

**POWER SOURCE:** Six 120-V, lead-acid batteries supply 105 amp-hr of power for propulsion and lighting. Batteries are located external to the pressure hull and are pressure-compensated.

**LIFE SUPPORT:** Two 20-ft<sup>3</sup> capacity tanks in the pressure hull holds sufficient O<sub>2</sub> for 96 man-hr. Six perforated trays hold a total of 16 lb Baralyme to absorb CO<sub>2</sub>. Air is circulated by a fan to facilitate CO<sub>2</sub> removal and is monitored periodically as is atmospheric pressure.

**VIEWING:** Two, acrylic plastic viewports 120° apart looking forward and slightly below the horizontal for pilot/passenger. These two ports are 3.5 in. thick, 4.7-in. ID, 6.55-in. OD and provide overlapping coverage at 80° each. Between the two large ports is a 1.65-in.-diam. camera port. Three wide-angle optical windows look upwards and provide 170° field of view.

**OPERATING/SCIENTIFIC EQUIPMENT:** UQC (42-kHz), gyrocompass, depth gage, up/down echo sounder, 35-mm external camera. Hydraulic boom (5 ft extension) holds a 2,500-W light source for internal 16-mm cine camera.

**MANIPULATORS:** One mounted port side forward, hydraulically driven, with two degrees of freedom (shoulder/hand). Basically this is a pivoted arm (rotating in one plane) which folds under the brow when not in use and is extended downward in the vertical to grasp. The vehicle itself can be maneuvered to attain somewhat greater arm versatility.

**SAFETY FEATURES:** Inflatable conning tower around hatch for emergency surface exit. 400-lb mechanically releasable weight. Trim mercury (275 lb) jettisonable. Scuba tanks inside hull for emergency breathing.

**SURFACE SUPPORT:** SOO.

**OWNER:** Campagnes Oceanographique Francaises, Monaco.

**BUILDER:** Office Francais de Recherches Sous-Marine, Marseilles, France.

**REMARKS:** Operational. Redesignated SP-350 in 1970 following repressurization of all components to assure greater operational depth capability. Also known as DIVING SAUCER, DENICE, DS-2, SP-300 and LA SOUCOUBE PLONGEANTE.

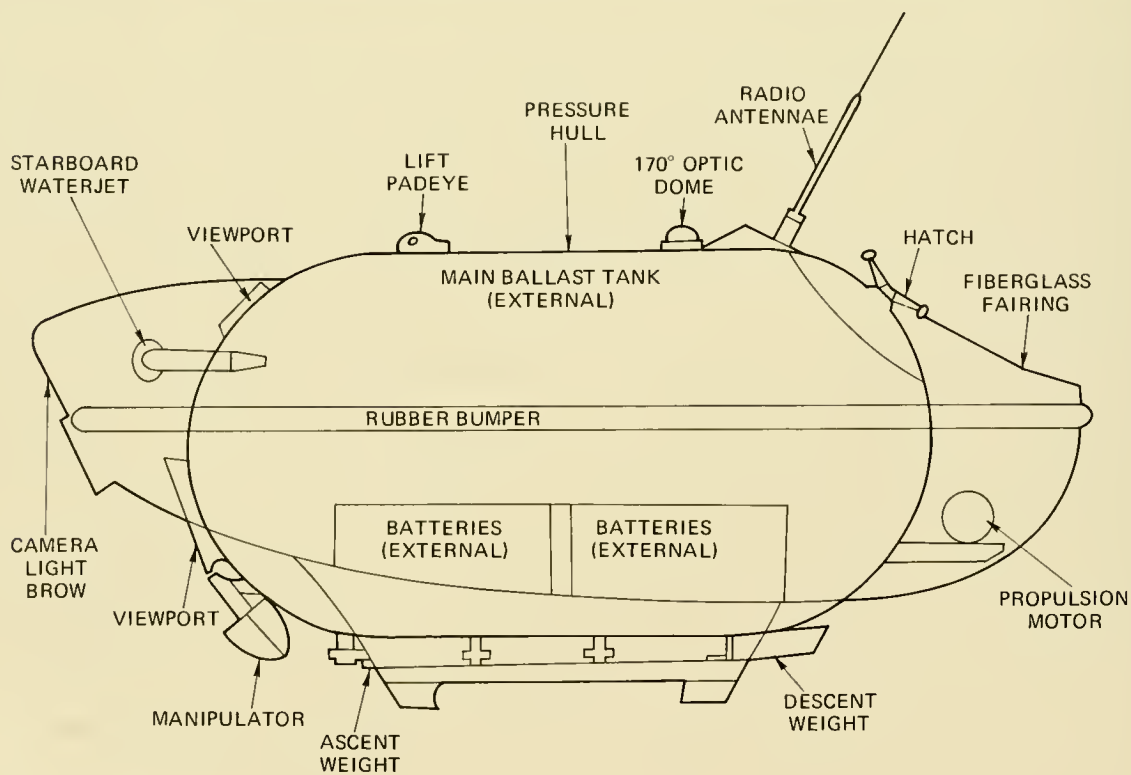



SP-500

LENGTH: ..... 2.9 m  
 BEAM: ..... 1.93 m  
 HEIGHT: ..... 1.35 m  
 DRAFT: ..... NA  
 WEIGHT (DRY): ..... 2,400 kg  
 OPERATING DEPTH: ..... 500 m  
 COLLAPSE DEPTH: ..... 3,000 m  
 LAUNCH DATE: ..... 1969

HATCH DIAMETER: ..... 0.4 m  
 LIFE SUPPORT (MAX): ..... 12 man-hr  
 TOTAL POWER: ..... 6.8 kWh  
 SPEED (KNOTS): CRUISE ..... 0.8/2 hr  
 MAX ..... 1.1/1.5 hr  
 CREW: PILOTS ..... 1  
 OBSERVERS ..... 0  
 PAYLOAD: ..... 45 kg

**PRESSURE HULL:** Cylindrical shape steel with two hemispherical endcaps; ID of 1.03 m; length of 2.0 m.

**BALLAST/BUOYANCY:** Launched negatively buoyant, 40-kg descent weight; 20-kg ascent weight. There are twenty-one 1-kg lead weights which may be dropped individually and 20 kg of water ballast for fine buoyancy control.

**PROPULSION/CONTROL:** Water jets with reversible-directional nozzles and a 2-hp electric motor which drives water through a "Y" shaped valve for yaw control. Jets rotate 270° in the vertical.

**TRIM:** Up/down bow angles of ±30° can be attained by transporting 70 kg of mercury fore or aft.

**POWER SOURCE:** Pressure-compensated, lead-acid batteries of 125 V at 55 amp-hr.

**LIFE SUPPORT:** O<sub>2</sub> is carried within the pressure hull and is automatically set and released into the hull. Cartridges containing IR8 are used to absorb CO<sub>2</sub>.

**VIEWING:** Three viewports, one large and two small. Large viewport on centerline is 120-mm OD with 80° field of view. Two smaller viewports are left and right of large port at 46°; they are 60-mm OD and allow 80° of view. Aft and astern is a wide-angle viewport of 170° enabling viewing upward in the vertical.

**OPERATING/SCIENTIFIC EQUIPMENT:** Gyrocompass, echo sounder (down/forward) pinger, UOC, cine cameras, radio, directional antennae.

**MANIPULATORS:** One hydraulically-operated arm and claw capable of two degrees of freedom.

**SAFETY FEATURES:** One 50-kg weight and mercury dump of 70 kg. Inflatable hatch trunk, flares, smoke signal, portable scuba for emergency breathing.

**SURFACE SUPPORT:** SOO.

**OWNER:** Campagnes Oceanographique Francaises, Monaco.

**BUILDER:** Sud Aviation, France.

**REMARKS:** Inactive. Two similar vehicles. Also known as PUCE de MER or OCEAN FLEAS.

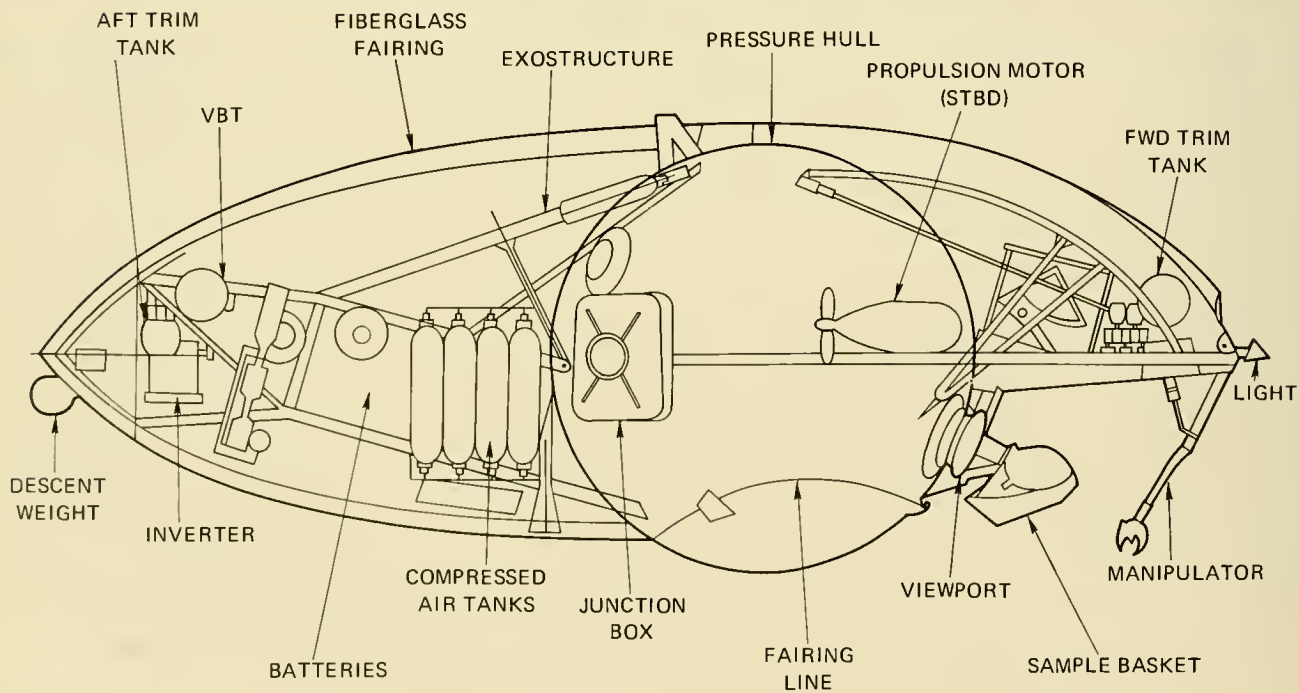





## SPORTSMAN 300 & 600

	300	600	300	600
LENGTH: .....	12 ft	13 ft	HATCH DIAMETER: .....	NA
BEAM: .....	4.3 ft	5.5 ft	LIFE SUPPORT (MAX): .....	16 man-hr
HEIGHT: .....	4.75 ft	5.2 ft	TOTAL POWER: .....	4.2 kWh
DRAFT: .....	NA	NA	SPEED (KNOTS): CRUISE .....	2/8 hr
WEIGHT (DRY): .....	1 ton	1.75 tons	MAX .....	4/3 hr
OPERATING DEPTH: .....	300 ft	600 ft	CREW: PILOTS .....	1
COLLAPSE DEPTH: .....	1,300 ft	NA	OBSERVERS .....	1
LAUNCH DATE: .....	1961	1963	PAYLOAD: .....	450 lb
				700 lb

**PRESSURE HULL:** Cylindrical shape of high-strength, welded and dimecoted A-36 steel  $\frac{3}{16}$  in. thick, partially reinforced with  $\frac{3}{8}$ -in. double plate and 2-in. flat bar rings for the 300 model. The 600 model is composed of 0.5-in.-thick A-36 steel.

**BALLAST/BUOYANCY:** Surface buoyancy is supplied by two, side-mounted  $\frac{1}{6}$ -in.-thick ballast tanks. A small tank within the pressure hull provides small adjustment in buoyancy when submerged. A low pressure (150 psi) tank is normally used to blow main ballast, a high pressure (2,000 psi) tank is carried in reserve.

**PROPULSION/CONTROL:** A 3-hp electric motor (12 and 24 VDC) with two speeds forward and reverse drives a stern-mounted propeller. Bow-mounted dive planes and a rudder provide underway attitude control.

**TRIM:** No systems provided.

**POWER SOURCE:** 300 Model: four, 175-amp-hr, 6-VDC, lead-acid batteries. 600 Model: four, 6-VDC, nickel-cadmium batteries.

**LIFE SUPPORT:**  $O_2$  is carried within the pressure hull in a 15-ft<sup>3</sup>-capacity tank and bled off as needed.  $CO_2$  is removed by Baralyme. A snorkel device may be used on or just below the surface. A barometer is carried to measure cabin pressure changes.

**VIEWING:** The conning tower has circular wrap-around windows 4 in. wide and 1 in. thick. The 600 model has an 8-in.-diam. viewport in the bow.

**OPERATING/SCIENTIFIC EQUIPMENT:** CB radio, depth gage, compass.

**MANIPULATORS:** None.

**SAFETY FEATURES:** High pressure air for emergency ballast blow at operating depth. A 150-lb droppable weight on the keel.

**SURFACE SUPPORT:** SOO.

**OWNER:** Several of these vehicles are reportedly built, the only ones which have been located are The Tiburon Marine Laboratory, Tiburon, Calif. (300 Model) and the Brazosport College, Lake Jackson, Texas (600 Model).

**BUILDER:** American Submarine Co., Lorain, Ohio.

**REMARKS:** None of the models located are operating.

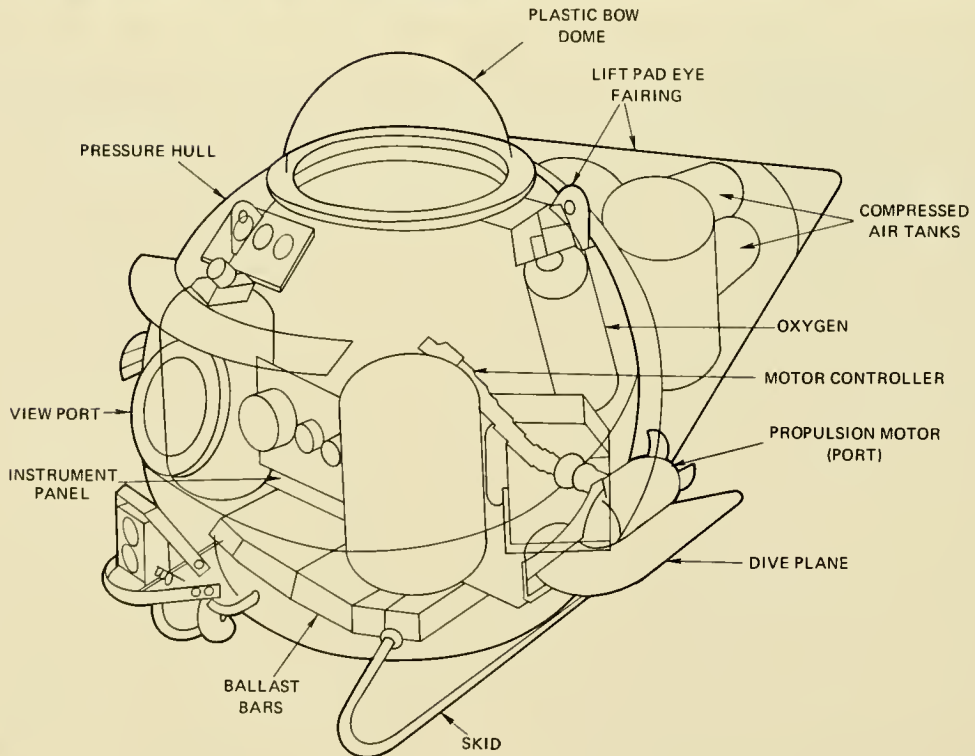
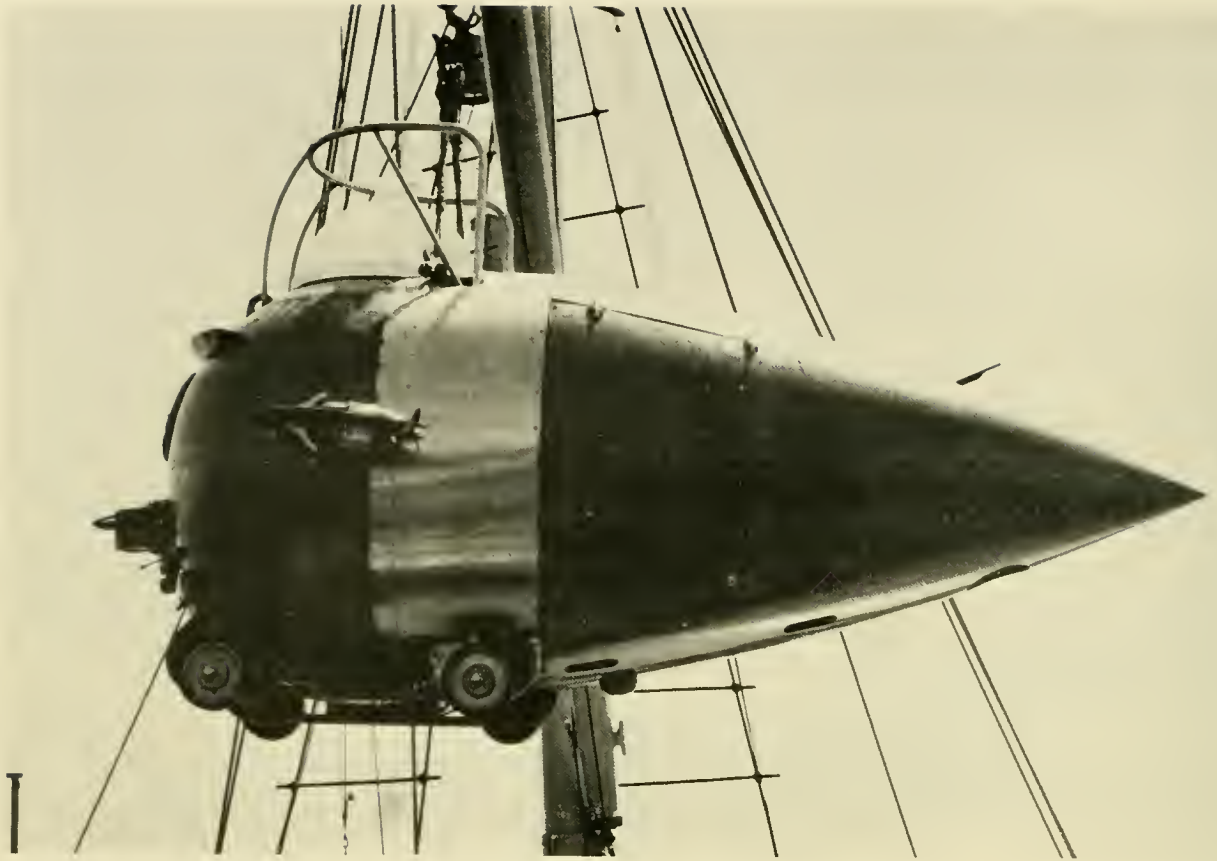

## STAR I

LENGTH: ..... 10 ft  
BEAM: ..... 4 ft  
HEIGHT: ..... 5.8 ft  
DRAFT: ..... NA  
WEIGHT (DRY): ..... 2,750 lb  
OPERATING DEPTH: ..... 200 ft  
COLLAPSE DEPTH: ..... 400 ft  
LAUNCH DATE: ..... 1963

HATCH DIAMETER: ..... 19 in.  
LIFE SUPPORT (MAX): ..... 18 man-hr  
TOTAL POWER: ..... 4.3 kWh  
SPEED (KNOTS): CRUISE .....  $3/4/3$  hr  
MAX ..... 1/1 hr  
CREW: PILOTS ..... 1  
OBSERVERS ..... 0  
PAYLOAD: ..... 200 lb

**PRESSURE HULL:** Spherical shape 4 ft in diameter,  $3/8$  in. thick, A 212 grade B steel. Penetrations include two viewports, hatch and two shafts for rotating side pods.

**BALLAST/BUOYANCY:** Six main seawater ballast tanks of 375-lb capacity. Ballast is blown by 144-ft<sup>3</sup> (STP) air at 2,250 psi. Auxiliary ballast tank inside pressure hull to obtain fine buoyancy control.

**PROPULSION/CONTROL:** Two side-mounted, rotatable, 0.25-hp, 24-VDC motors. Both steering and depth are controlled by rotating the motors and differentially controlling their speed.

**TRIM:** None.

**POWER SOURCE:** Two externally-mounted, pressure-compensated, 24-VDC, 72-amp-hr, lead-acid batteries for propulsion and one 12-VDC, 72-amp-hr battery for instrumentation. Has carried experimental fuel cell.

**LIFE SUPPORT:** CO<sub>2</sub> scrubber system with blower. D<sub>2</sub> is carried in an 18-ft<sup>3</sup> (STP) bottle. Emergency system consists of a scuba regulator which can be attached to the high pressure air supply or a scuba bottle.

**VIEWING:** Two 7-in.-diam, flat plate plexiglass viewports on the centerline. Axis of one looks forward and up 15° above horizontal. The other looks down and forward 45° below the horizontal.

**OPERATING/SCIENTIFIC EQUIPMENT:** UQC, directional gyro, echo sounder, depth gage, CB radio, avoidance sonar.

**MANIPULATORS:** None.

**SAFETY FEATURES:** Droppable weight of 200 lb. External salvage and air connections. Emergency breathing off main de-ballasting air or portable flask.

**SURFACE SUPPORT:** SDO.

**OWNER:** Philadelphia Maritime Museum.

**BUILDER:** General Dynamics Corp., Electric Boat Div., Groton, Conn.

**REMARKS:** On display.

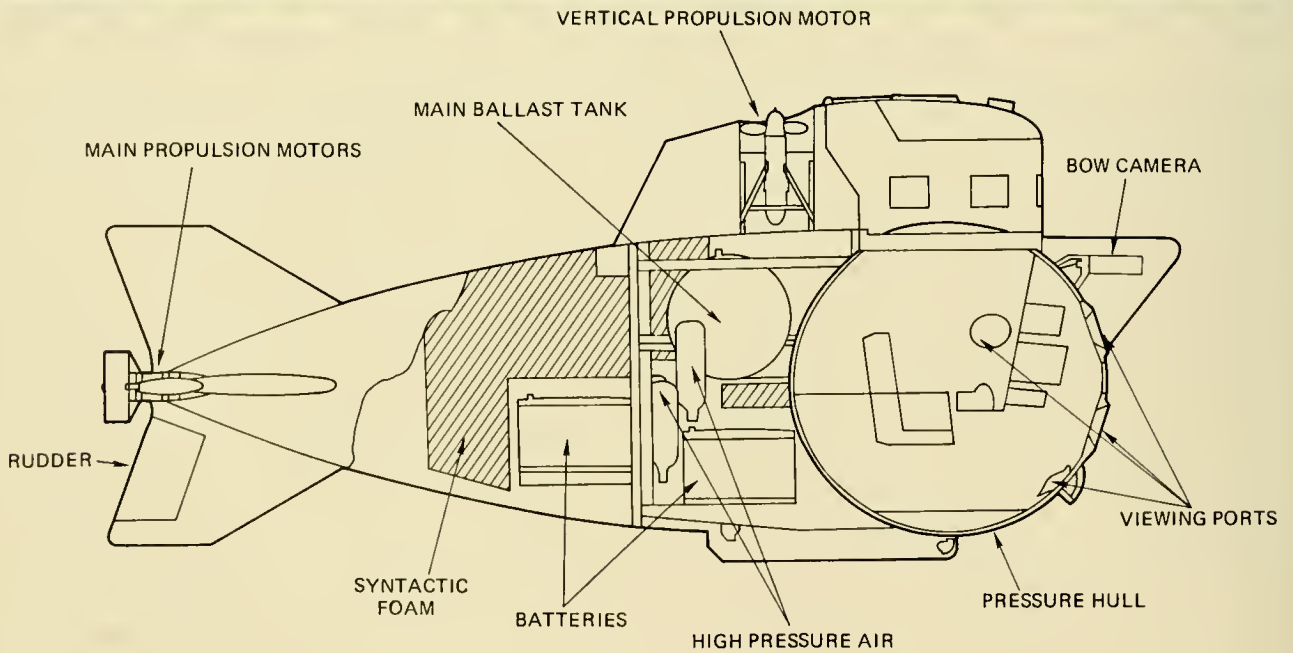
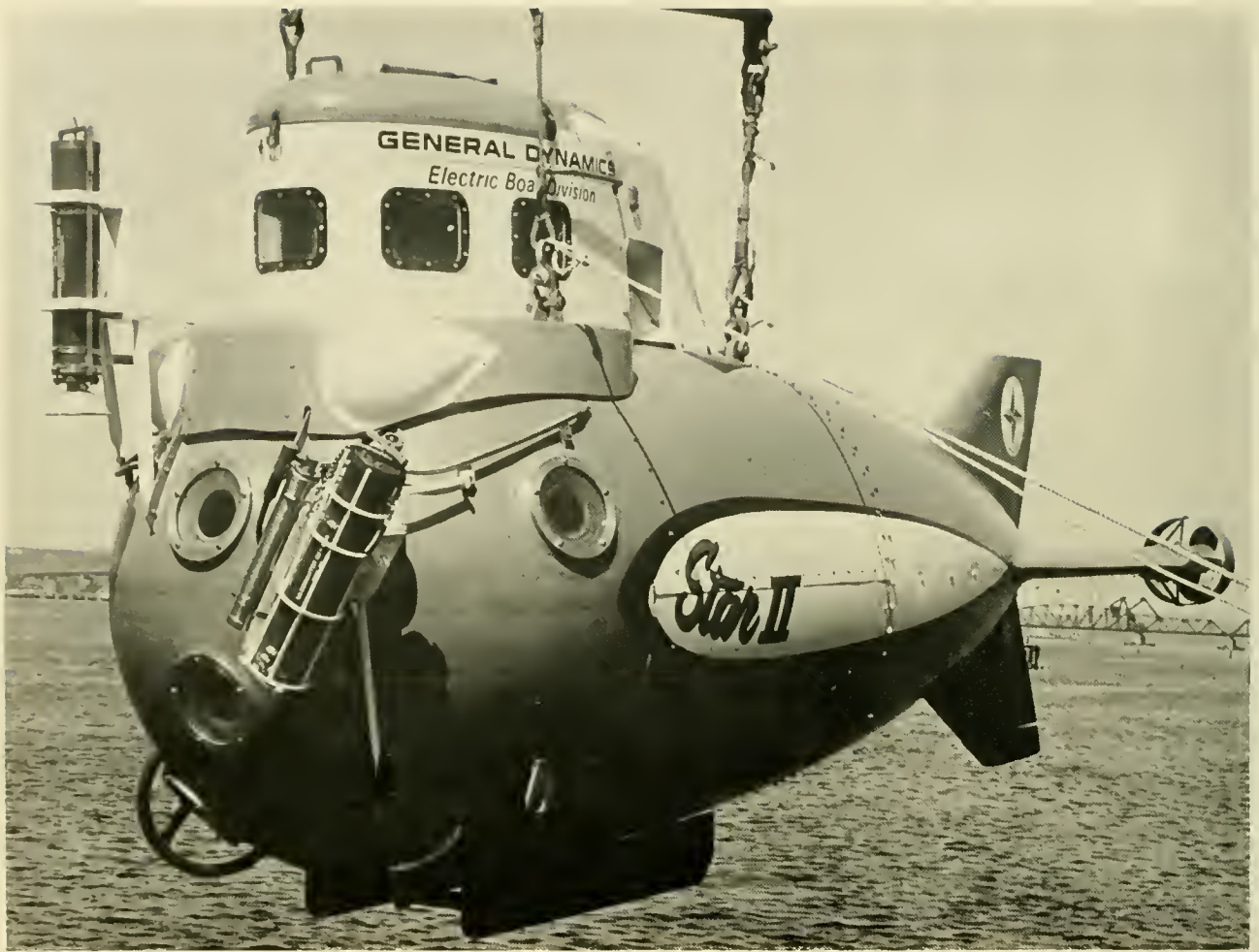



## STAR II

LENGTH: ..... 17.75 ft  
BEAM: ..... 5.3 ft  
HEIGHT: ..... 7.7 ft  
DRAFT: ..... 4.9 ft  
WEIGHT (DRY): ..... 5 tons  
OPERATING DEPTH ..... 1,200 ft  
COLLAPSE DEPTH: ..... 2,400 ft  
LAUNCH DATE: ..... 1966

HATCH DIAMETER: ..... 20 in.  
LIFE SUPPORT (MAX): ..... 48 man-hr  
TOTAL POWER: ..... 14.8 kWh  
SPEED (KNOTS): CRUISE ..... 1/10 hr  
                  MAX ..... 3/1.5 hr  
CREW: PILOTS ..... 1  
      OBSERVERS ..... 1  
PAYLOAD: ..... 250 lb

**PRESSURE HULL:** Spherical shape, 5-ft ID, 5/8 in. thick, of HY-80 steel.

**BALLAST/BUOYANCY:** Main ballast tank of 500-lb capacity is blown by four tanks of compressed air at 2,250 psi. Auxiliary seawater ballast tank of 130-lb capacity is used to obtain buoyancy adjustments when submerged. Two blocks of syntactic foam (30-pcf density) are carried fore and aft to provide additional positive buoyancy.

**PROPULSION/CONTROL:** Main propulsion is provided by two propellers mounted aft on stabilizing fins and driven by a 2-hp, DC motor at 900 rpm which is reversible. Immediately behind the hatch is a vertical thruster of similar characteristics as the main propulsion units. Electrically-driven rudder controls underway lateral maneuvering.

**TRIM:** No systems provided.

**POWER SOURCE:** Main power is derived from externally-mounted, pressure-compensated lead-acid batteries (Exide 3-FN-17) providing 180 amp-hr at 115 VDC.

**LIFE SUPPORT:** Gaseous  $D_2$  is carried within the hull.  $CO_2$  is removed by soda sorb.

**VIEWING:** Six viewports 5-in. ID, 9-in. OD and 0.625 in. thick. A smaller viewport (2-in. ID) is located in the hatch cover.

**OPERATING/SCIENTIFIC EQUIPMENT:** UQC, CB radio, still camera, TV, pinger, Magnesyn compass, altitude/depth echo sounder, depth gage.

**MANIPULATORS:** One.

**SAFETY FEATURES:** Droppable skid (300 lb). Emergency battery pack in pressure hull. Scuba regulator in pressure hull provides emergency breathing by drawing off the deballasting air supply. Hull can be flooded for emergency egress.

**SURFACE SUPPORT:** SOO.

**OWNER:** Electric Boat Div., General Dynamics Corp., Groton, Conn.

**BUILDER:** Same as above.

**REMARKS:** Operating. On loan to Deep Water Exploration Ltd., Honolulu, Hawaii.

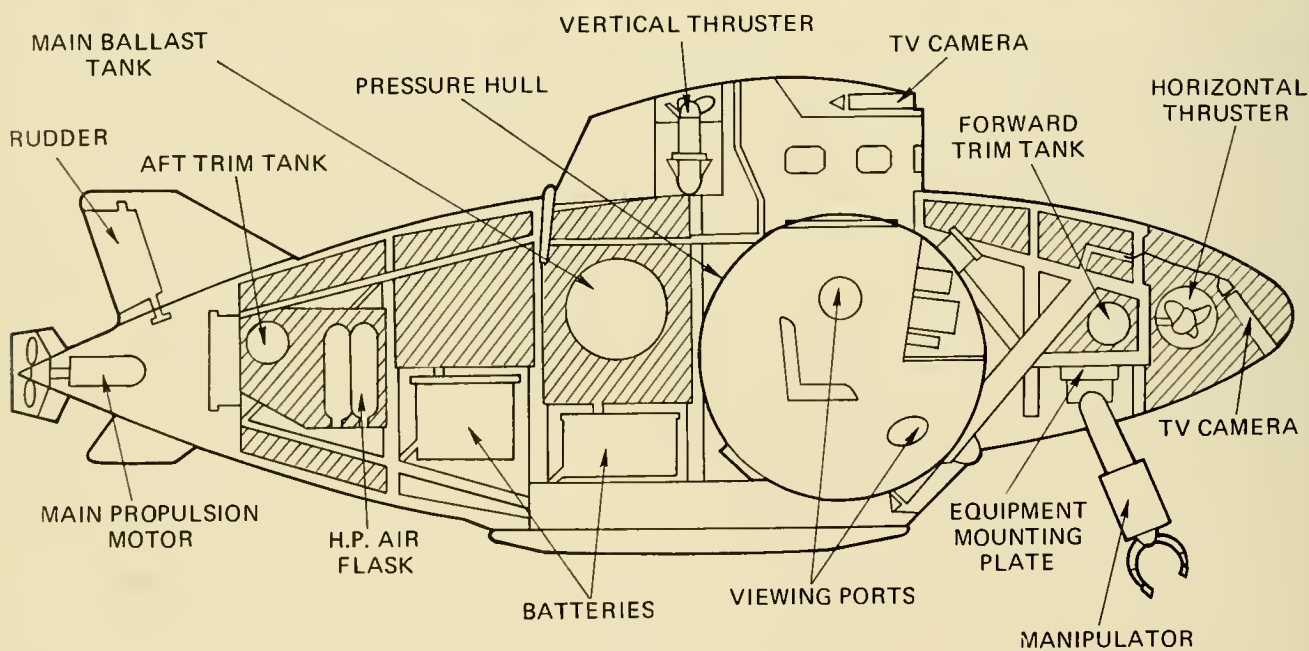

## STAR III

LENGTH: ..... 24.5 ft  
BEAM: ..... 6.75 ft  
HEIGHT: ..... 8 ft  
DRAFT: ..... 6.5 ft  
WEIGHT (DRY): ..... 10.5 tons  
OPERATING DEPTH: ..... 2,000 ft  
COLLAPSE DEPTH: ..... 4,000 ft  
LAUNCH DATE: ..... 1966

HATCH DIAMETER: ..... 20 in.  
LIFE SUPPORT (MAX): ..... 120 man-hr  
TOTAL POWER: ..... 30 kWh  
SPEED (KNOTS): CRUISE ..... 1/12 hr  
                          MAX ..... 4/1.5 hr  
CREW: PILOTS ..... 1  
          OBSERVERS ..... 1  
PAYLOAD: ..... 1,000 lb

**PRESSURE HULL:** Spherical shape, 5.5-ft ID, 0.5 in. thick and made of HY-100 steel.

**BALLAST/BUOYANCY:** NA.

**PROPULSION/CONTROL:** Main propulsion is provided by a stern-mounted, reversible, 7.5-hp propeller. One vertical and one horizontal thruster, each powered by a 2-hp motor, assist in maneuvering. An electrically-actuated rudder assists in underway maneuvering.

**TRIM:** Bow angles of  $\pm 30^\circ$  can be obtained by transferring mercury between fore and aft tanks.

**POWER SOURCE:** Sixty, external, pressure-compensated, lead-acid battery cells provide 29 kWh of 120-VDC power at a 10-hr discharge rate. This can be converted to 115 VAC, 60 Hz.

**LIFE SUPPORT:** A pressure regulator automatically bleeds  $O_2$  from a 72-ft<sup>3</sup>-capacity tank into the hull.  $CO_2$  is removed by soda sorb. A reserve  $O_2$  tank is carried that is manually operated as desired. Monitors for  $O_2$ ,  $CO_2$  and cabin pressure. Emergency breathing is from two scuba regulators drawing off the high pressure air supply.

**VIEWING:** There are five viewports, each is 2 in. thick with a 5-in. ID and a 9-in. OD. Three of the ports look forward and are depressed  $33^\circ$  from the horizontal. One of these is on the vertical centerline. The remaining two viewports are raised approximately  $10^\circ$  above the horizontal and are located  $90^\circ$  to the right and left of the centerline. Each viewport has a field of view of  $69^\circ$  in water.

**OPERATING/SCIENTIFIC EQUIPMENT:** UQC, CB radio, pinger, Magnesyn compass, altitude/depth echo sounder, depth gage, two TV cameras, still camera.

**MANIPULATORS:** One with six degrees of freedom.

**SAFETY FEATURES:** Lead weight (250 lb) drops automatically if high pressure air supply drops below 185 psi above ambient seawater pressure. Manipulator jettisonable. Hull can be flooded for emergency egress.

**SURFACE SUPPORT:** SOO.

**OWNER:** Scripps Institute of Oceanography, La Jolla, Calif.

**BUILDER:** Electric Boat Div., General Dynamics Corp., Groton, Conn.

**REMARKS:** Not operating.



## SUBMANAUT

LENGTH: ..... 9.5 ft  
BEAM: ..... 4.2 ft  
HEIGHT: ..... 4.75 ft  
DRAFT: ..... 3 ft  
WEIGHT (DRY): ..... 2.75 tons  
OPERATING DEPTH: ..... 200 ft  
COLLAPSE DEPTH: ..... 2,000 ft  
LAUNCH DATE: ..... 1963

HATCH DIAMETER: ..... 16.5 in.  
LIFE SUPPORT (MAX): ..... 24 man-hr  
TOTAL POWER: ..... 3.5 kWh  
SPEED (KNOTS): CRUISE ..... 1.1/4 hr  
MAX ..... 1.6/2 hr  
CREW: PILOTS ..... 1  
OBSERVERS ..... 1  
PAYLOAD: ..... 1,200 lb

**PRESSURE HULL:** Elliptically-shaped pressure hull, with a major axis of 96 in. and a minor axis of 42 in. It is constructed of 128 rings of 0.75-in-thick plywood bonded together. The radial thickness of the rings is 4 in. and the assembled hull is covered with 0.75-in.-thick glass reinforced plastic giving a total hull thickness of 4.75 in. The hatch is of steel with a flat gasket seal.

**BALLAST/BUOYANCY:** A water ballast tank located within the pressure hull provides  $\pm 110$ -lb buoyancy and may be manually pumped or blown with air. External ballast tanks are presently under construction.

**PROPULSION/CONTROL:** Forward and reverse thrust is provided by a 1.5-hp, 1,800-rpm, 24-VDC motor mounted on centerline aft. Two 1/3-hp, 800-rpm motors are mounted on the main motor casing, one vertically and one horizontally to provide vertical and horizontal thrust. Pneumatically-actuated diving planes and rudder are also mounted aft for altitude control while underway.

**TRIM:** No static trim or list control is provided. Underway trim is controlled by the diving planes and vertical thruster.

**POWER SOURCE:** Four 6-V, 120-amp-hr, lead-acid batteries connected in series and one 12-V battery are carried inside the pressure hull.

**LIFE SUPPORT:** O<sub>2</sub> resupply is accomplished manually from a 60-SCF O<sub>2</sub> tank and CO<sub>2</sub> is scrubbed using a blower to recirculate cabin air. A desiccant is used to reduce humidity.

**VIEWING:** A single 4-in.-thick plexiglass viewport with an OD of 24 in. is located at the bow. Because of the method of mounting, a viewing angle of 170° is obtained when in the water. The ID of the window is 12 in.

**OPERATING/SCIENTIFIC EQUIPMENT:** UQC, speed/distance indicator, water temperature sensor, depth gage, pinger.

**MANIPULATORS:** None.

**SAFETY FEATURES:** 300 lb of lead in segments formed to the hull are held in place with a steel band around the hull forward of the conning tower. The band can be released hydraulically from inside the pressure hull to jettison the weights.

**SURFACE SUPPORT:** SUBMANAUT is transported on a modified auto trailer and launched by moving the trailer down any available boat launching ramp. No support ship has been used for transport.

**OWNER:** Helle Engineering, Inc., San Diego, Calif.

**BUILDER:** Same as above.

**REMARKS:** Not operating.



## SUBMANAUT

LENGTH: ..... 43 ft  
BEAM: ..... 10.75 ft  
HEIGHT: ..... 16 ft  
DRAFT: ..... 9 ft  
WEIGHT (DRY): ..... 50.5 tons  
OPERATING DEPTH: ..... 600 ft  
COLLAPSE DEPTH: ..... NA  
LAUNCH DATE: ..... 1956

HATCH DIAMETER: ..... 34 in.  
LIFE SUPPORT (MAX): ..... 300 man-hr  
TOTAL PDWER: ..... 91 kWh  
SPEED (KNOTS): CRUISE ..... 3/20 hr  
MAX ..... 4.5/10 hr  
CREW: PILOTS ..... 2  
OBSERVERS ..... 4  
PAYLOAD: ..... 4,500 lb

**PRESSURE HULL:** Cylindrical shape, constructed of an inner and outer hull 9/16 in. thick, 10/30 carbon steel, welded, air-peened and stress relieved. Honeycomb reinforcement between hulls. Conning tower is 1.0-in.-thick rolled steel.

**BALLAST/BUOYANCY:** To obtain  $\pm$  buoyancy there are four hull tanks (346 gal ea.) and two keel tanks (140 gal ea.). Tanks may be emptied by pumps (high & low pressure systems) or compressed air. Fine buoyancy control is obtained by adding or subtracting water from smaller tanks, 945 gal are required to submerge leaving 5-35 gal to obtain negative buoyancy. Ballast pumps are: a 10-hp, 80-gpm at 300 psi (high pressure) and a 5-hp, 400-gpm at 25 psi (low pressure).

**PROPULSION/CONTROL:** Main propulsion is provided by a stern-mounted, 38 in. x 34 in. propeller. Underway maneuvering is obtained through a rudder and dive planes.

**TRIM:** No systems provided.

**POWER SOURCE:** Surface, General Motors, 6-cylinder diesel engine developing 235 hp. Submerged: lead-acid batteries in each "leg" are in pressure-resistant cases. There is a 115-V bank in each leg with a total of nineteen 12-V units of 400-amp-hr capacity. Batteries are recharged on the surface by the diesel engine.

**LIFE SUPPORT:** Two tanks containing 200 ft<sup>3</sup> of O<sub>2</sub> are carried within the pressure hull. Three circulating blowers with attached soda lime cannisters are used to remove CO<sub>2</sub>. Two bunks are available.

**VIEWING:** Three, 2.5-in.-thick, Plex R (Rohm & Haas) wrap-around windows are on the forward hemihead; they are two 17 in. x 48 in. and one 17 in. x 16 in. all on a 51-in. radius in the same horizontal plane. Conning tower has one window 20 in. x 14 in., 3 in. thick, on a 20-in. radius. Six additional glass (crown optical) viewports, 6 in. thick, 7-in. DD and 5.75-in. ID, are located throughout the vehicle.

**OPERATING/SCIENTIFIC EQUIPMENT:** Gyrocompass with three repeaters, depth sounder, radio telephone.

**MANIPULATORS:** None.

**SAFETY FEATURES:** The entire keel ("legs") section is manually releasable and totals 3,240 lb. Dry chemical fire extinguisher, life vests.

**SURFACE SUPPORT:** Independent operation.

**OWNER:** Uncertain, as of August 1968 vehicle was owned by Submarine Services Inc., Coral Gables, Fla.

**BUILDER:** Martine's Diving Bells Inc., San Diego, Calif.

**REMARKS:** Not operating.

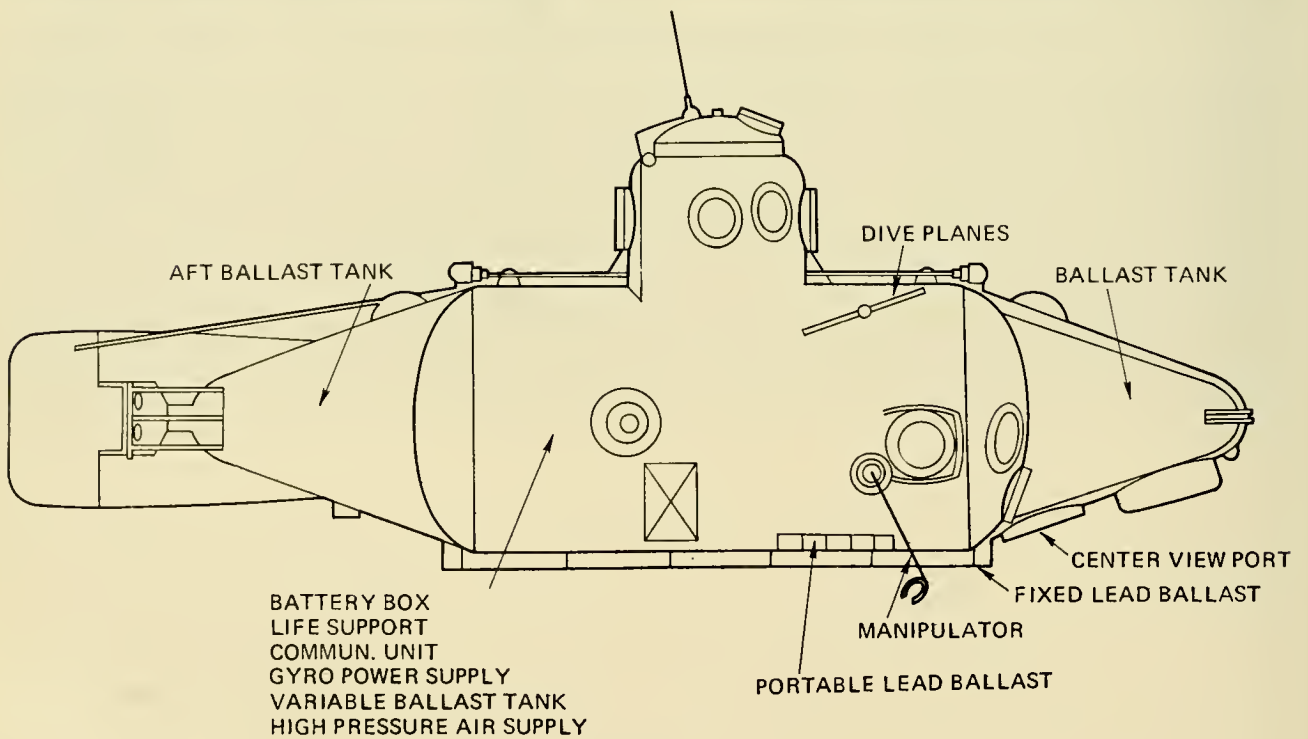



## SUBMARAY

LENGTH: ..... 14 ft  
BEAM: ..... 3 ft  
HEIGHT: ..... 5 ft  
DRAFT: ..... 2.1 ft  
WEIGHT (DRY): ..... 1.45 tons  
OPERATING DEPTH: ..... 300 ft  
COLLAPSE DEPTH: ..... 1,100 ft  
LAUNCH DATE: ..... 1962

HATCH DIAMETER: ..... 18 in.  
LIFE SUPPORT (MAX): ..... 32 man-hr  
TOTAL POWER: ..... 4.5 kWh  
SPEED (KNOTS): CRUISE ..... 2/6 hr  
MAX ..... NA  
CREW: PILOTS ..... 1  
OBSERVERS ..... 1  
PAYLOAD: ..... 450 lb

**PRESSURE HULL:** Cylindrical shape composed of mild steel (boiler plate) 36-in. ID; 88 in. long and  $\frac{3}{8}$  in. thick.

**BALLAST/BUOYANCY:** Main ballast is provided through 900-lb-capacity tanks blown with high pressure air. An 8.5-gal-capacity tank serves as a variable buoyancy tank.

**PROPULSION/CONTROL:** A stern-mounted propeller provides forward and reverse maneuverability and is powered by a 24-VDC, 2-hp, 1,800-rpm, 1-speed, forward/reverse motor. A rudder aft of the propeller and dive planes on the bow provide lateral and vertical maneuvering, respectively.

**TRIM:** No systems provided.

**POWER SOURCE:** Four, 6-V, 190-amp-hr, lead-acid batteries supply main power. Dry cell batteries power CB radio and UQC.

**LIFE SUPPORT:**  $O_2$  is carried within the pressure hull in a 50-ft<sup>3</sup> tank.  $CO_2$  is removed by blowing cabin air through Baralyme. A barometer monitors cabin pressure and a hydrometer monitors humidity.

**VIEWING:** Four viewports, 7-in. diam. in lower hull. Eight, 6-in.-diam. ports in conning tower.

**OPERATING/SCIENTIFIC EQUIPMENT:** UQC, depth gage, forward-scanning and downward-looking recording echo sounders. CB radio, gyrocompass.

**MANIPULATORS:** None.

**SAFETY FEATURES:** Manually droppable 40-lb weights, main ballast blows at maximum operating depth, pressure hull may be flooded to allow escape, marker buoy can be released from within vehicle.

**SURFACE SUPPORT:** SOO.

**OWNER:** Kinautics Inc., Winchester, Mass.

**BUILDER:** C & D Tools, Calif.

**REMARKS:** Not operating.

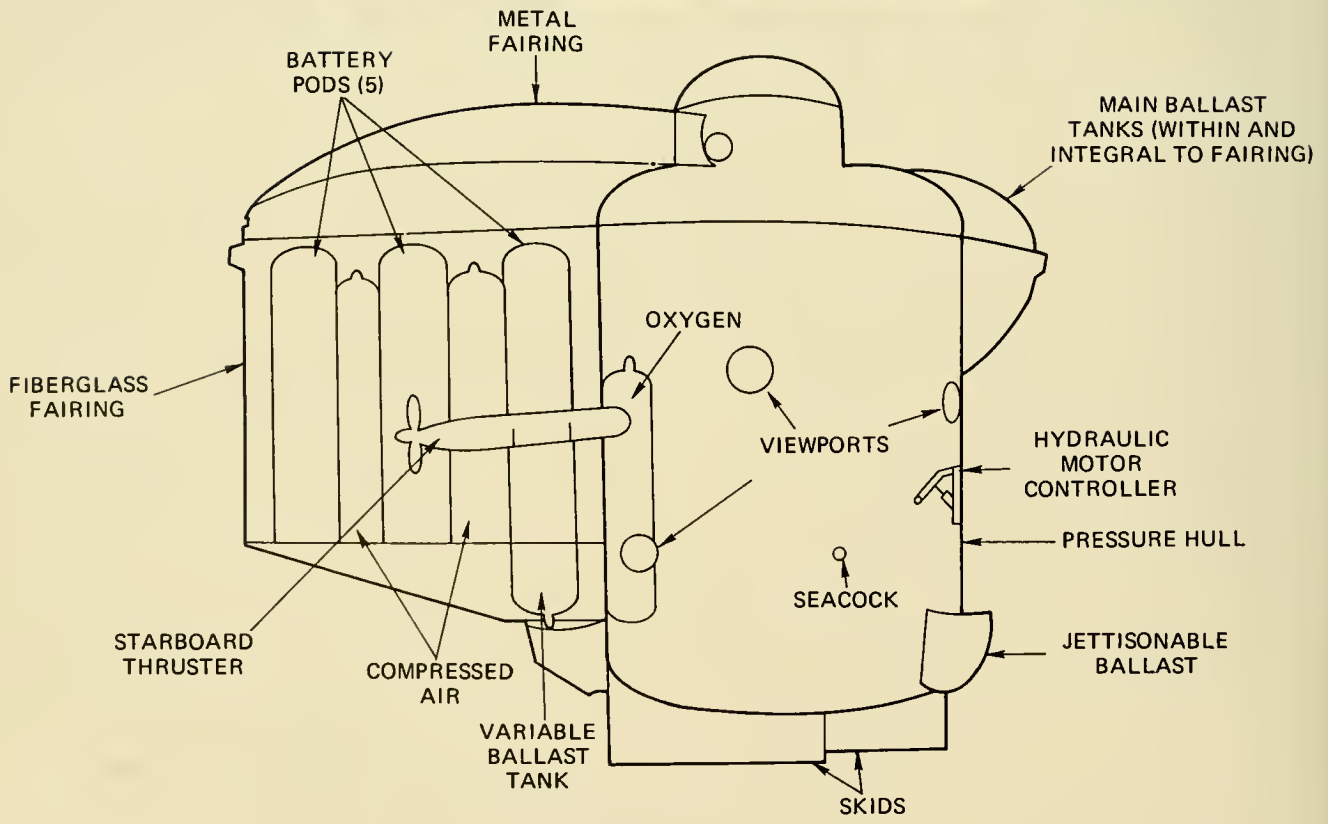
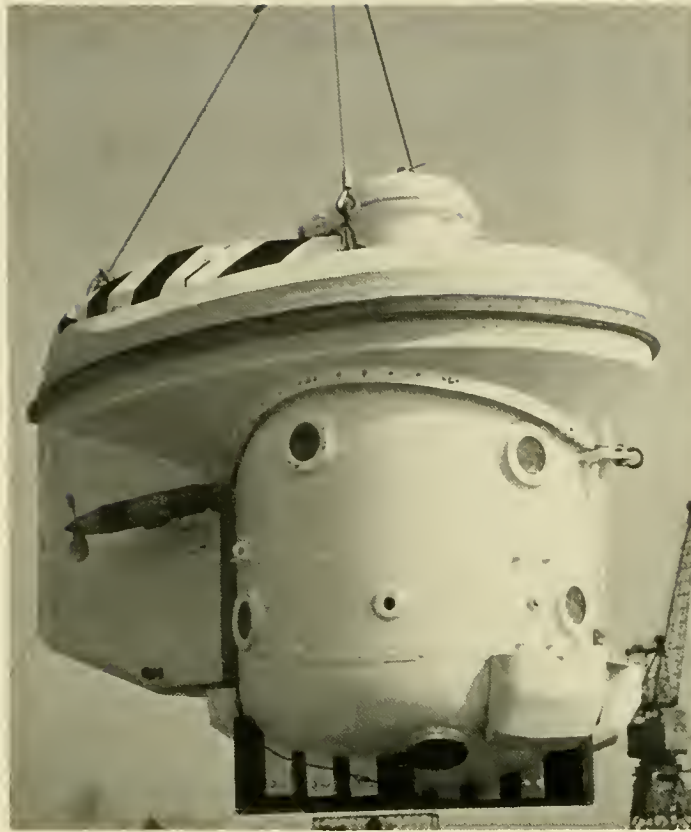

## SURV

LENGTH: ..... 10.9 ft  
BEAM: ..... 6.3 ft  
HEIGHT: ..... 9.5 ft  
DRAFT: ..... NA  
WEIGHT (DRY): ..... 6.1 tons  
OPERATING DEPTH: ..... 600 ft  
COLLAPSE DEPTH: ..... 4,800 ft  
LAUNCH DATE: ..... 1967

HATCH DIAMETER ..... NA  
LIFE SUPPORT (MAX): ..... 100 man-hr  
TOTAL POWER: ..... 12 kWh  
SPEED (KNOTS): CRUISE ..... 0.5/9 hr  
MAX ..... 2.5  
CREW: PILOTS ..... 1  
OBSERVERS ..... 1  
PAYLOAD: ..... 250 lb

**PRESSURE HULL:** Cylindrical shape with "dish" endcaps composed of mild steel plate to BS 1501/151B. Cylinder is 1.1/8 in. thick; upper endcap is 1.5 in. thick; lower endcap is 1.5/8 in. thick. Total length 6.5 ft, ID of 5 ft.

**BALLAST/BUOYANCY:** Three free-flooding tanks within fiberglass fairing around pressure hull provide surface buoyancy of 850 lb. They are blown by a 275-ft<sup>3</sup>-capacity, 2,500-psi air tank. Tanks may be blown at 600-ft depth. Two trim tanks of ±40-lb capacity located aft of the pressure hull provide submerged buoyancy control. An identical backup blowing system is carried.

**PROPULSION/CONTROL:** Lateral propulsion is provided by two (port/starboard), variable-speed, 2.5-hp each motors. The motors are rotatable to provide any angle beyond 5° in the vertical.

**TRIM:** No systems.

**POWER SOURCE:** Lead-acid batteries (146-V) carried in five pressure-resistant cases.

**LIFE SUPPORT:** O<sub>2</sub> is supplied by two, 40-ft<sup>3</sup>, 1,850-psi tanks within the pressure hull and is manually controlled. CO<sub>2</sub> is absorbed in four soda lime cannisters of 3.5-lb capacity each. O<sub>2</sub> and CO<sub>2</sub> partial pressures are constantly displayed. An alarm system is automatically activated if CO<sub>2</sub> exceeds 1% or O<sub>2</sub> departs from 20% to 24%.

**VIEWING:** Ten plastic viewports in pressure hull are 2.25 in. thick; 7-in. OD and 4-in. ID. Three smaller viewports are located around the conning tower.

**OPERATING/SCIENTIFIC EQUIPMENT:** UQC, hard-line telephone (shallow depth), gyrocompass, rate-of-turn indicator, pressure depth gage, up/down echo sounder, speedometers, temperature gage.

**MANIPULATORS:** None.

**SAFETY FEATURES:** Portable emergency breathing sets (40 ft<sup>3</sup> of air ea.) are provided. Jettisonable weights (850 lb). Main ballast tanks can be blown at operating depth. Pressure hull can be flooded for personnel egress.

**SURFACE SUPPORT:** SOO.

**OWNER:** Lintott Engineering Ltd., Horsham, England.

**BUILDER:** Same.

**REMARKS:** Retired 1969.

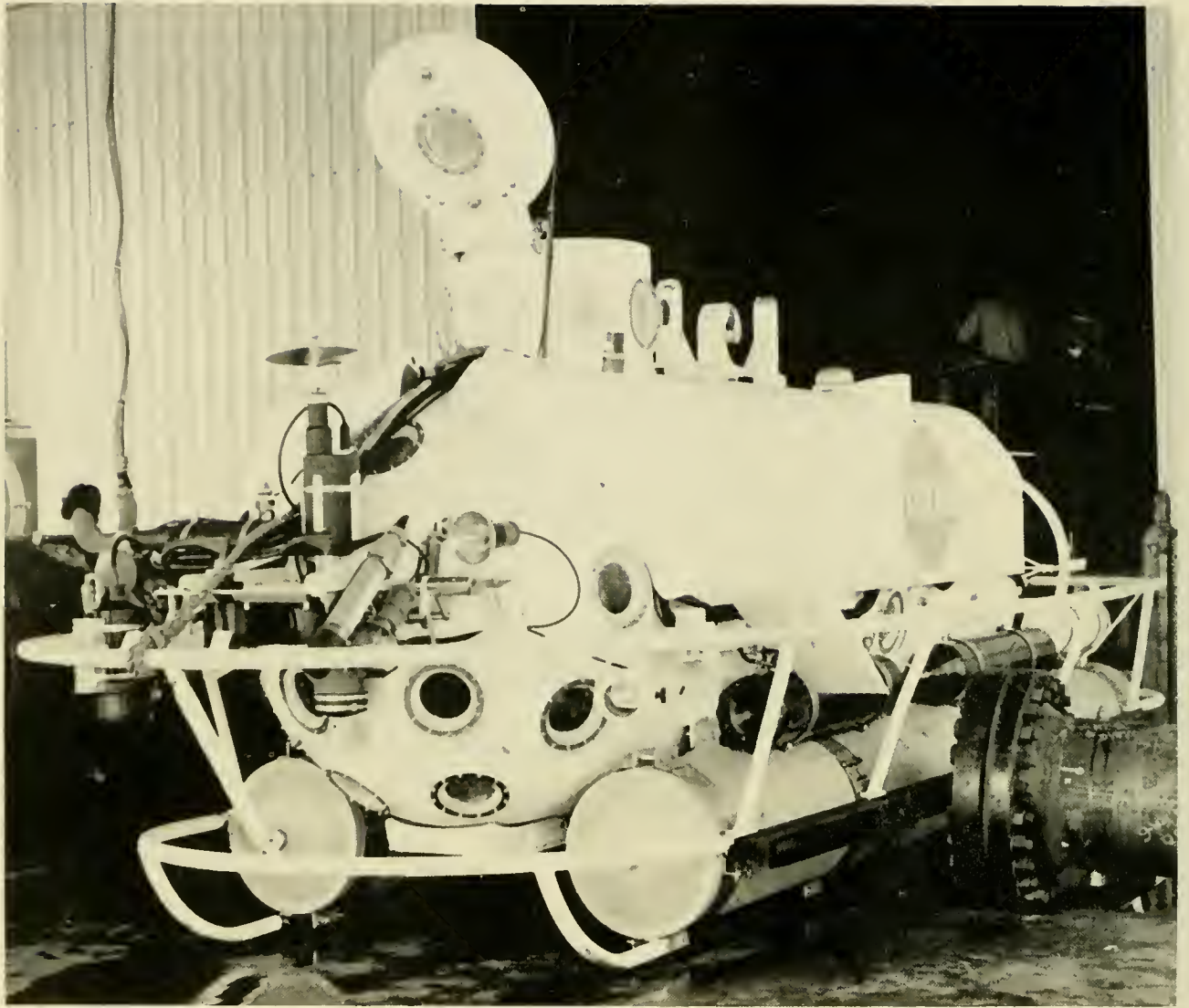

## SURVEY SUB 1

LENGTH: ..... 26 ft  
BEAM: ..... 7.1 ft  
HEIGHT: ..... 8 ft  
DRAFT: ..... 5.3 ft  
WEIGHT (DRY): ..... 11.25 tons  
OPERATING DEPTH: ..... 1,350 ft  
COLLAPSE DEPTH: ..... 2,500 ft  
LAUNCH DATE: ..... 1970

HATCH DIAMETER: ..... 24 in.  
LIFE SUPPORT (MAX): ..... 216 man-hr  
TOTAL POWER: ..... 49.9 kWh  
SPEED (KNOTS): CRUISE ..... 1.5/10 hr  
MAX ..... 4.5 hr  
CREW: PILOTS ..... 1  
OBSERVERS ..... 2  
PAYLOAD: ..... 500 lb

**PRESSURE HULL:** Cylindrical shape of SA-537 grade A normalized steel 9/16 in. thick, 54-in. ID, 218-in. length.

**BALLAST/BUOYANCY:** Main buoyancy (1,100 lb) is from a soft reservoir tank connected to a smaller hard tank; both are blown by compressed air. Two internal, fore/aft tanks control fine buoyancy or trim ( $\pm 400$  lb).

**PROPULSION/CONTROL:** Main propulsion is through a variable-speed reversible 10-hp, DC electric motor mounted in a water-tight container in the stern which drives a stern propeller. One single-speed reversible bow thruster (0.75-hp) and two 0.5-hp vertical thrusters provide low speed maneuvering. Hydraulically activated bow planes and rudder control attitude underway. An automatic pilot controls rudder angle.

**TRIM:** Two, internally-mounted, fore and aft tanks can be differentially filled with seawater to attain up/down angles on the bow.

**POWER SOURCE:** Twin battery pods, 18-in. diam. of SA53 grade B steel, contain 6-V, lead-acid heavy duty batteries providing 120 VDC main power (41.6 kWh at 20 hr) and 24-VDC auxiliary power (8.3 kWh at 20 hr).

**LIFE SUPPORT:** Gaseous O<sub>2</sub> (four tanks) is carried external to the pressure hull. 240-ft<sup>3</sup> total capacity. CO<sub>2</sub> is removed by LiOH (6.4 lb).

**VIEWING:** Twenty-one viewports; nine in the forward pressure hull, nine in the conning tower and three aft. All are 6.25-in. ID, 1.5 in. thick, 8-in. OD.

**OPERATING/SCIENTIFIC EQUIPMENT:** UQC, CB radio, Magnesyn compass, Doppler navigation sonar, scanning sonar, up/down recording echo sounder. Transponder and pinger, three TV's with three video recorders and five monitors.

**MANIPULATORS:** None.

**SAFETY FEATURES:** Ballast (1,150 lb) can be blown at maximum operating depth. Mechanically droppable 840-lb weight. Emergency breathing devices for each passenger. Flashing light.

**SURFACE SUPPORT:** Presently supported by the M/V WILLIAM DAMPIER, an off-shore oil supply boat 170 ft long, 39-ft beam, 9-ft draft which cruises at 12 knots and has a range of 6,500 n.m. A constant-tension, 50,000-lb-capability, stern A-Frame handling system is used for launch/retrieval. The support ship can berth 22 people, 2 of these accommodations are for customer personnel.

**OWNER:** Taylor Diving Services, Belle Chasse, La.

**BUILDER:** Parry Submarine Builders, Riviera Beach, Fla.

**REMARKS:** Operating. Originally designated PC-9 by Parry, recently redesignated TS-1 by present owner. Original owner, Brown and Root, gave it its SURVEY SUB 1 designation.

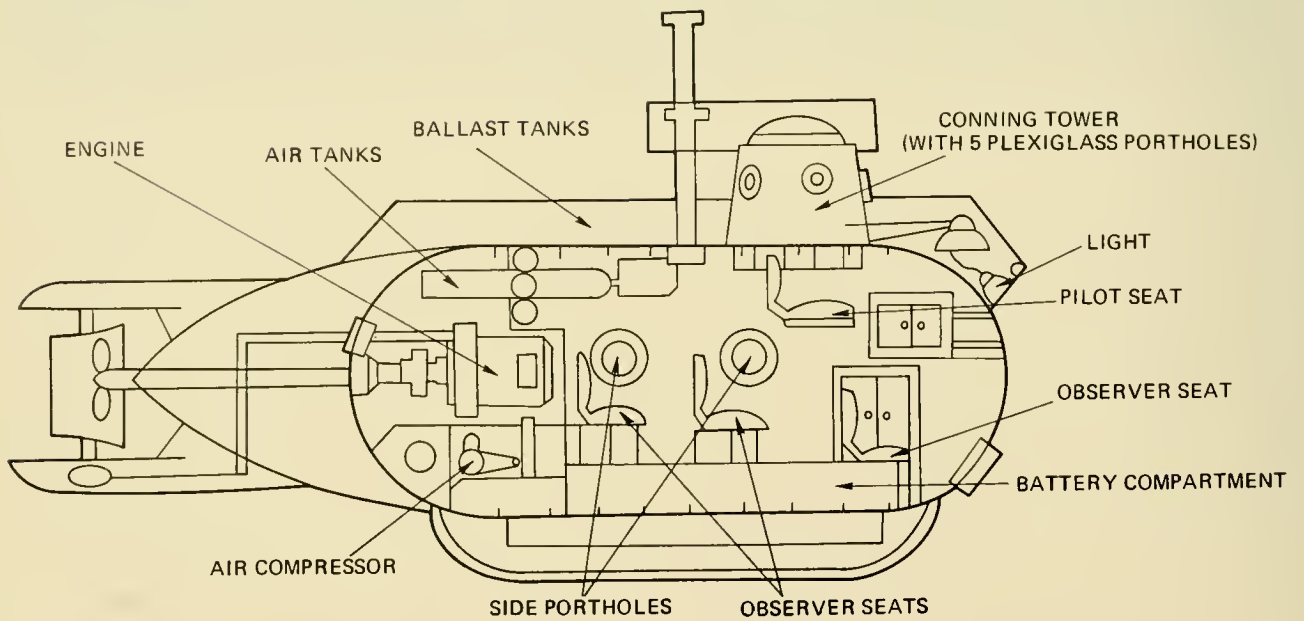
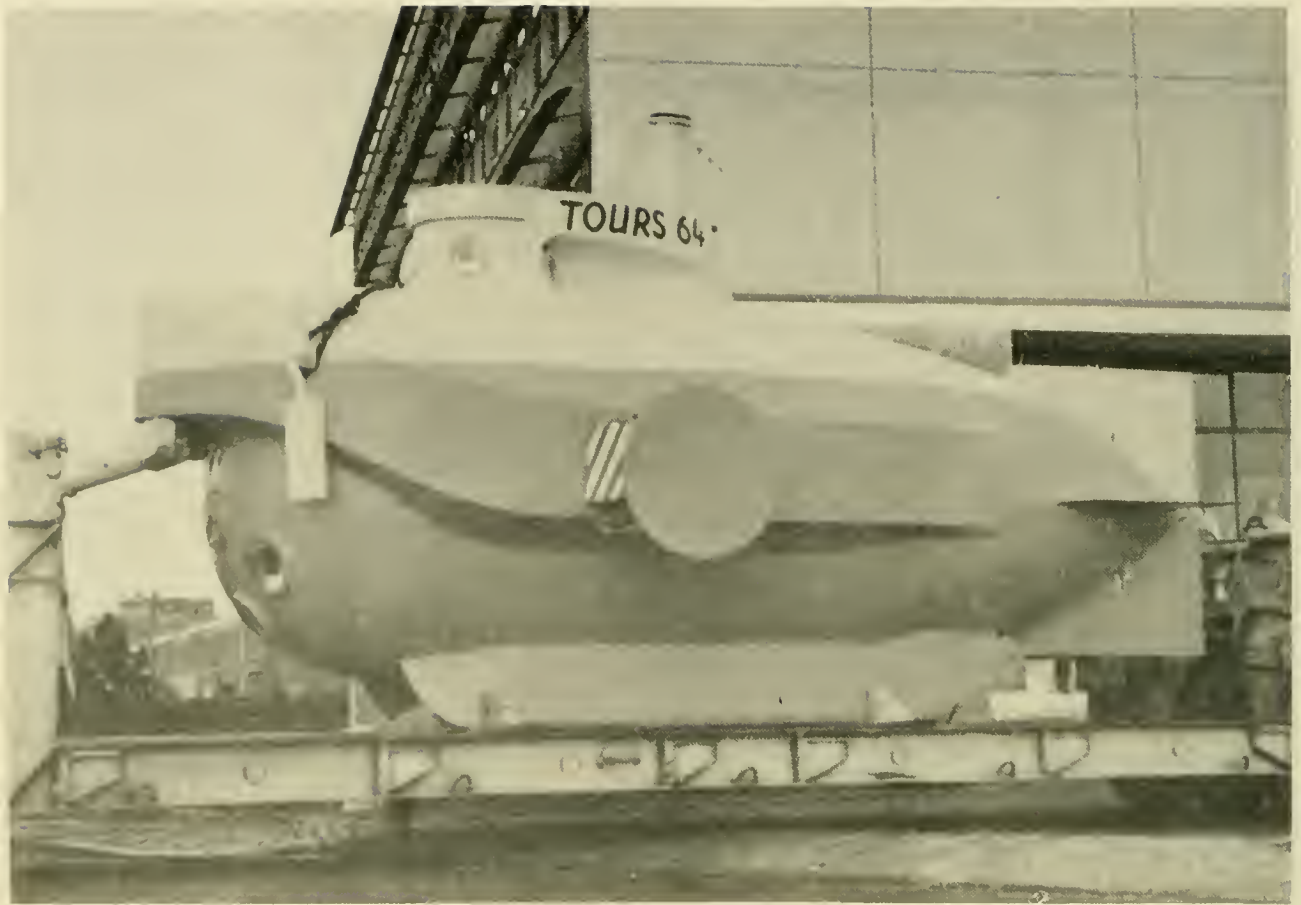



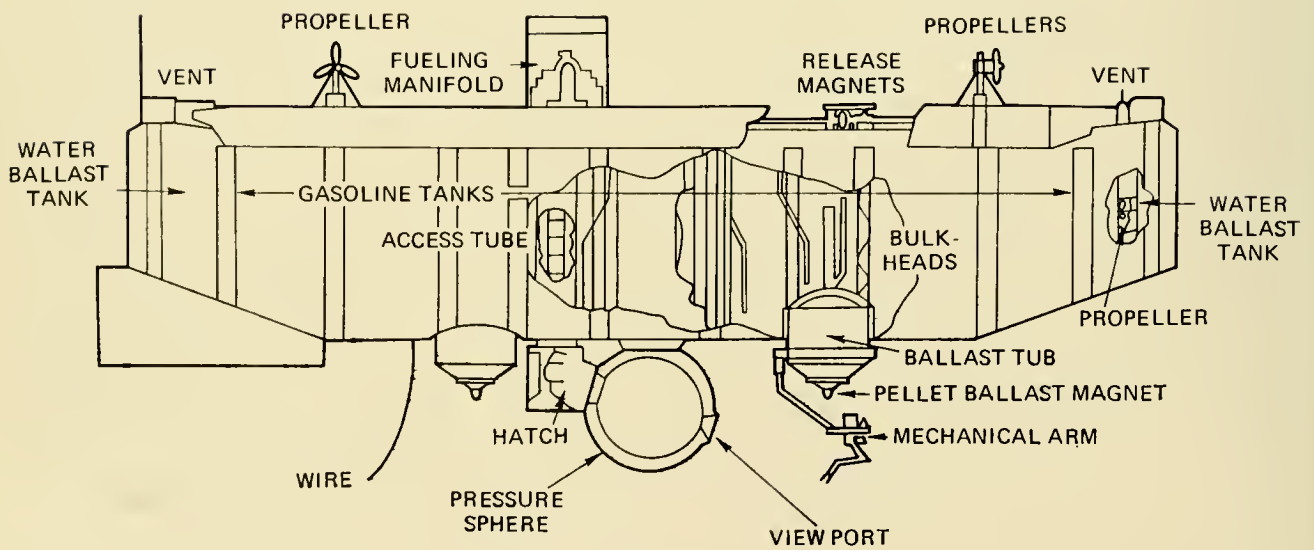
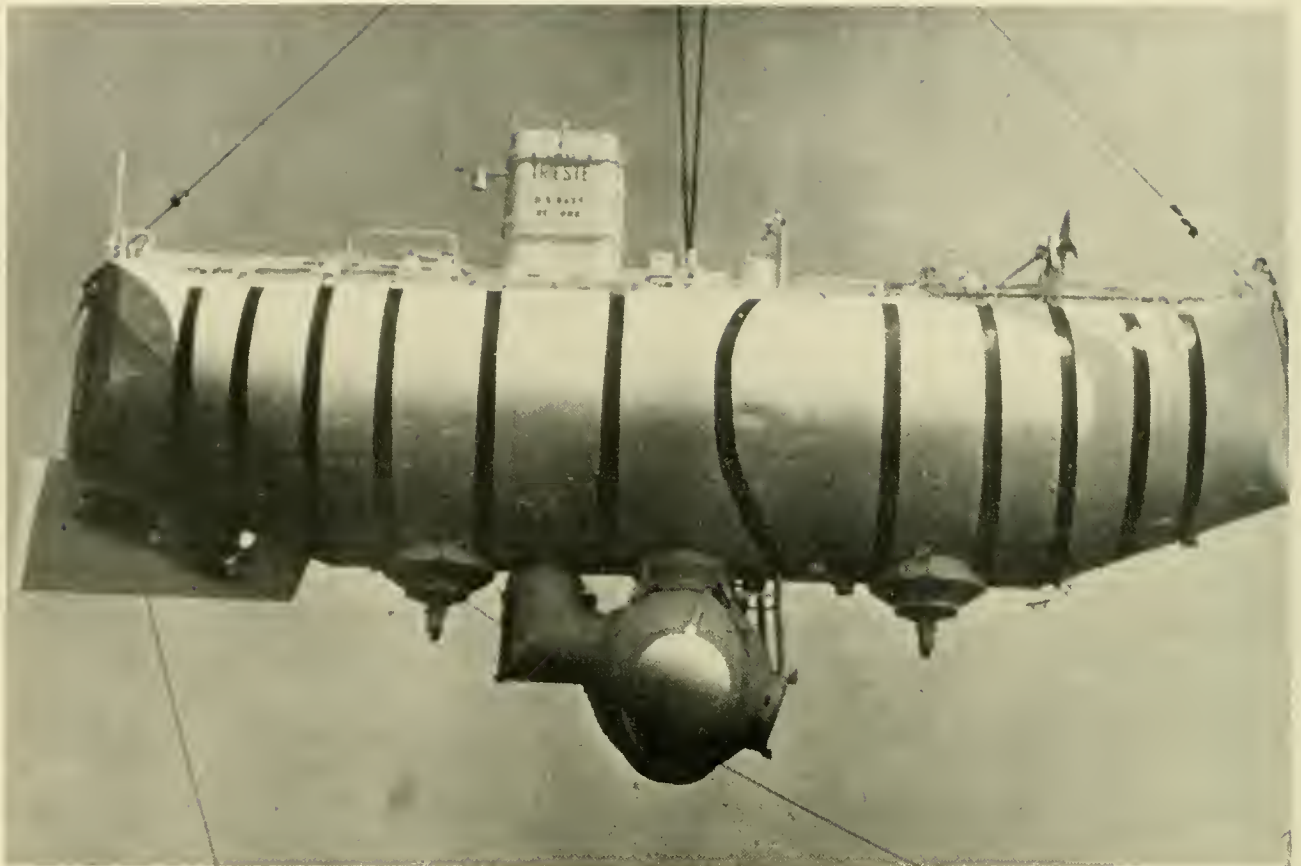



## TRIESTE I

LENGTH: ..... 59.5 ft  
BEAM ..... 11.5 ft  
HEIGHT: ..... NA  
DRAFT: ..... 18 ft  
WEIGHT (DRY): ..... NA  
OPERATING DEPTH: ..... No known ocean limit  
COLLAPSE DEPTH: ..... 60,000 ft  
LAUNCH DATE: ..... 1953

HATCH DIAMETER: ..... 16.9-in. ID; 22.5-in. OD  
LIFE SUPPORT (MAX): ..... NA  
TOTAL POWER: ..... NA  
SPEED (KNOTS): CRUISE ..... 0.5  
MAX ..... 0.5  
CREW: PILOTS ..... 1  
OBSERVERS ..... 2  
PAYLOAD: ..... NA

**PRESSURE HULL:** Spherical shape of three, Ni-Cr-Mo steel forgings 6.25-in. ID and 5 to 7 in. thick.

**BALLAST/BUOYANCY:** Buoyancy provided by 29,000 gal of aviation gasoline. Eleven tons of steel shot ballast carried in two hoppers is released to offset compression of gasoline as vehicle goes deeper. Release controlled through an electromagnet valve. Additional shot release over amount required to offset gasoline compression initiates ascent. A small fixed percentage of gasoline may be released to offset over release of shot if necessary.

**PROPULSION/CONTROL:** Two, 2-hp motors used for propulsion and steering. Motors in light casings filled with Trichlorethelene and pressure-compensated.

**TRIM:** Some bow angles obtainable by dropping shot only from one hopper.

**POWER SOURCE:** Initially lead-acid batteries in the sphere, these were replaced by silver-zinc batteries.

**LIFE SUPPORT:** Compressed, gaseous O<sub>2</sub> at constant flow rate equivalent to usage of two men, passed through an eductor, draws cabin air through three Drager (LiOH) canisters to remove CO<sub>2</sub>.

**VIEWING:** Two plastic conical viewports 2-in. ID, 16-in. OD and 7 in. thick.

**OPERATING/SCIENTIFIC EQUIPMENT:** UOC, echo sounder, depth gage.

**MANIPULATORS:** None.

**SAFETY FEATURES:** Electromagnetic shot valves fall open upon loss of power. Each of the two hoppers held in place electromagnetically may be jettisoned if valves fail and will release automatically in event of power loss. Gasoline compartments sized such that loss of all gasoline in one compartment will not reduce buoyancy below ability of reserve shot to compensate.

**SURFACE/ShORE SUPPORT:** Sea-going tug for tow to and from dive site.

**OWNER:** U.S. Navy.

**BUILDER:** Auguste and Jacques Piccard.

**REMARKS:** The above description is from the 1953-1959 period. TRIESTE I established and still holds the world's deepest dive record: 35,800 ft in the Challenger Deep (200 miles southwest of Guam) on 23 Jan. 1960. Aboard during this dive was Jacques Piccard and LT Don Walsh, USN. The float is now on display in the Navy Yard, Wash., D.C.

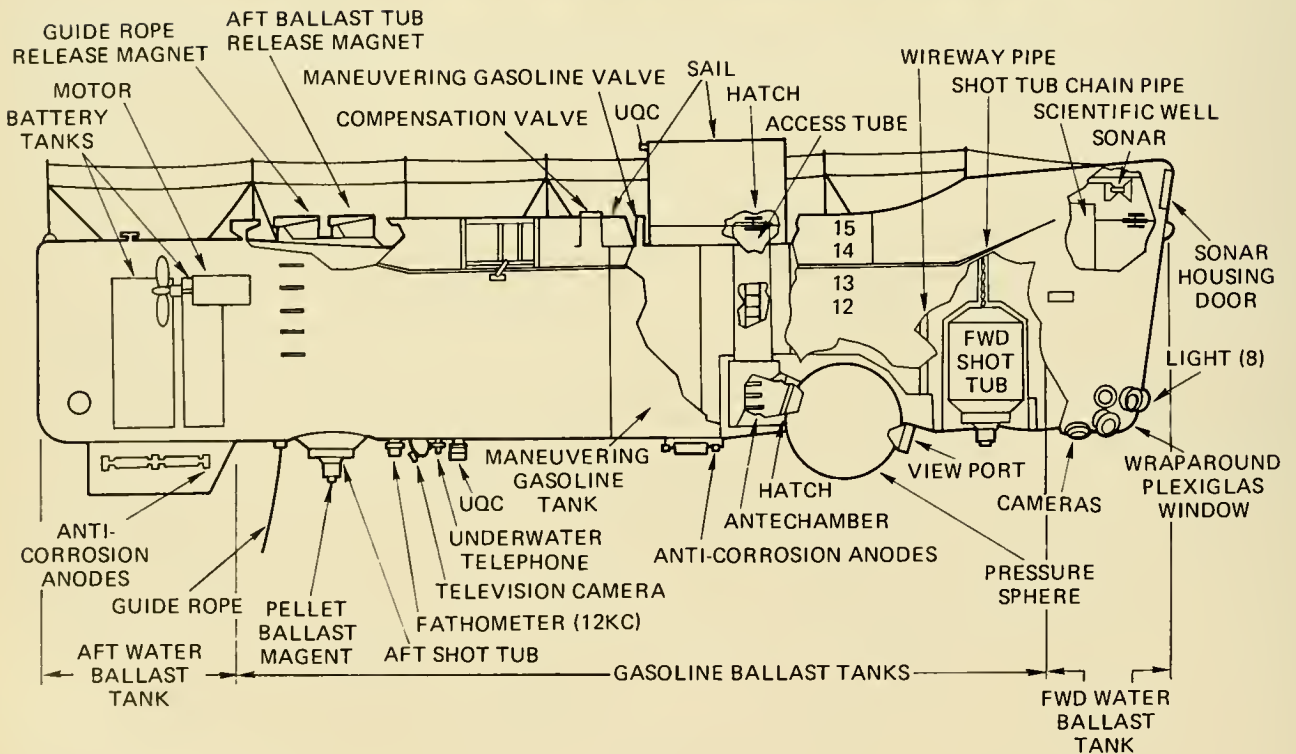
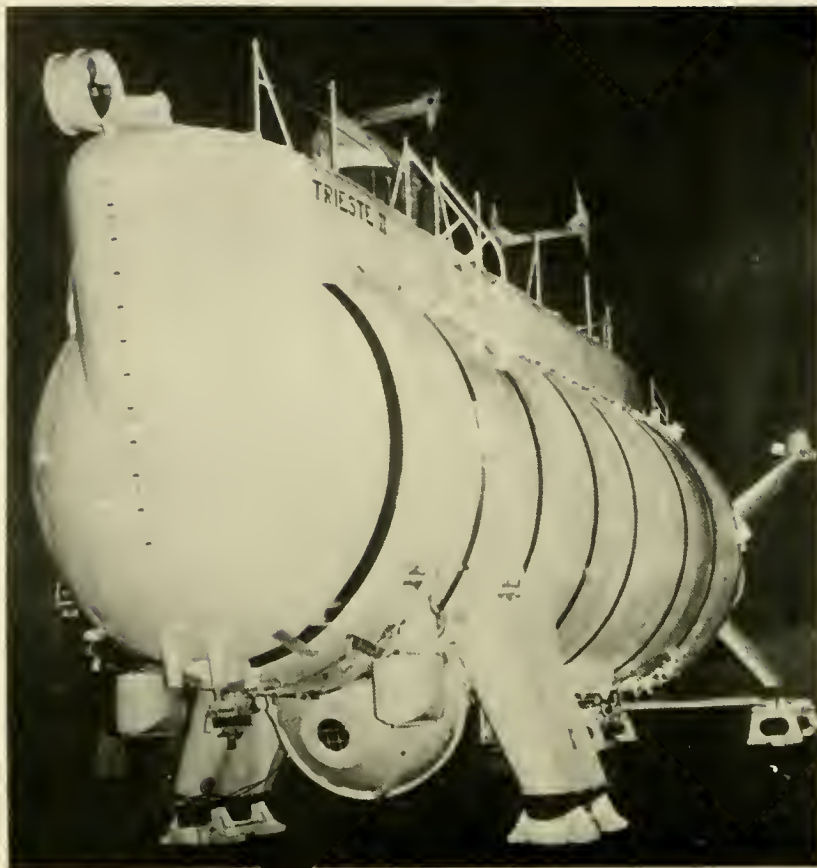

## TRIESTE II

LENGTH: ..... 78.6 ft  
BEAM: ..... 15.25 ft  
HEIGHT: ..... 26.9 ft  
DRAFT: ..... 21 ft  
WEIGHT (DRY): ..... 87.5 tons  
OPERATING DEPTH: ..... 20,000 tons  
COLLAPSE DEPTH: ..... >40,000 ft  
LAUNCH DATE: ..... 1964

HATCH DIAMETER: ..... 19.8-in. ID  
LIFE SUPPORT (MAX): ..... 72 man-hr  
TOTAL POWER: ..... NA  
SPEED (KNOTS): CRUISE ..... 2/12 hr  
MAX ..... NA  
CREW: PILOTS ..... 2  
OBSERVERS ..... 1  
PAYLOAD: ..... 5 tons

**PRESSURE HULL:** Spherical shape composed of two hemispheres of HY-120 steel clamped together on an equatorial flange. ID of 84 in., 3.9 in. thick to 6 in. at viewports and penetrations.

**BALLAST/BUOYANCY:** Aviation gasoline (65,830 gal) is carried in a thin-walled float to provide positive buoyancy. Electromagnetically held iron shot (22 tons) provides negative buoyancy and is incrementally released to ascend or decrease the vehicle's buoyancy. Trailing ball (250 & 750 lb) on 150-ft cable.

**PROPULSION/CONTROL:** Three, stern-mounted, 1,750-rpm, 120-VDC, 6.5-hp (each) motors provide main propulsion. A horizontal thruster is mounted on the bow.

**TRIM:** Shot hoppers mounted port/starboard amidships and one aft may be differentially filled to obtain  $\pm 12^\circ$  list, and  $+33^\circ$  to  $-27^\circ$  down bow angles at 20,000 ft.

**POWER SOURCE:** Externally-mounted, pressure-compensated silver-zinc batteries. Sixteen cells provide 5,000 amp-hr apiece at 24 V and 80 cells provide 952 amp-hr apiece at 120 V.

**LIFE SUPPORT:** Gaseous O<sub>2</sub>, three bottles, each 72 ft<sup>3</sup> at 2,250 psi (two normal, one emergency). CO<sub>2</sub> removed by LiOH. Monitors for O<sub>2</sub>, CO<sub>2</sub>, cabin pressure, temperature and humidity. Air conditioning system, Hull heat exchange system. Emergency breathing off O<sub>2</sub> bottle.

**VIEWING:** Four plastic viewports. One is 16-in. OD, the remaining three are 3-in. OD.

**OPERATING/SCIENTIFIC EQUIPMENT:** UQC, CTFM sonar, Doppler navigator, X-Y plotter, gyrocompass, altitude/depth sonar, echo sounder, transponder interrogator system, sound velocimeter, three still cameras, one cine camera, three TV's.

**MANIPULATORS:** One with six degrees of freedom.

**SAFETY FEATURES:** Shot and several outboard equipments jettisonable. Emergency breathing of 36 man-hr. Fail-safe shot jettison. Fire extinguisher. Distress rockets. Surface lights.

**SURFACE SUPPORT:** Transported by floating Dry Dock towed by an ocean-going tugboat.

**OWNER:** U.S. Navy, Submarine Development Group One, San Francisco, Calif.

**BUILDER:** U.S. Navy, Mare Island Shipyard, San Francisco, Calif.

**REMARKS:** Operational. Studies underway to substitute aviation gasoline with Isopar F., a lower flash-point fluid. Since its first major modification in 1964, TRIESTE II has undergone numerous, significant design and operational changes. The above description is how it now (Aug. 1974) stands.

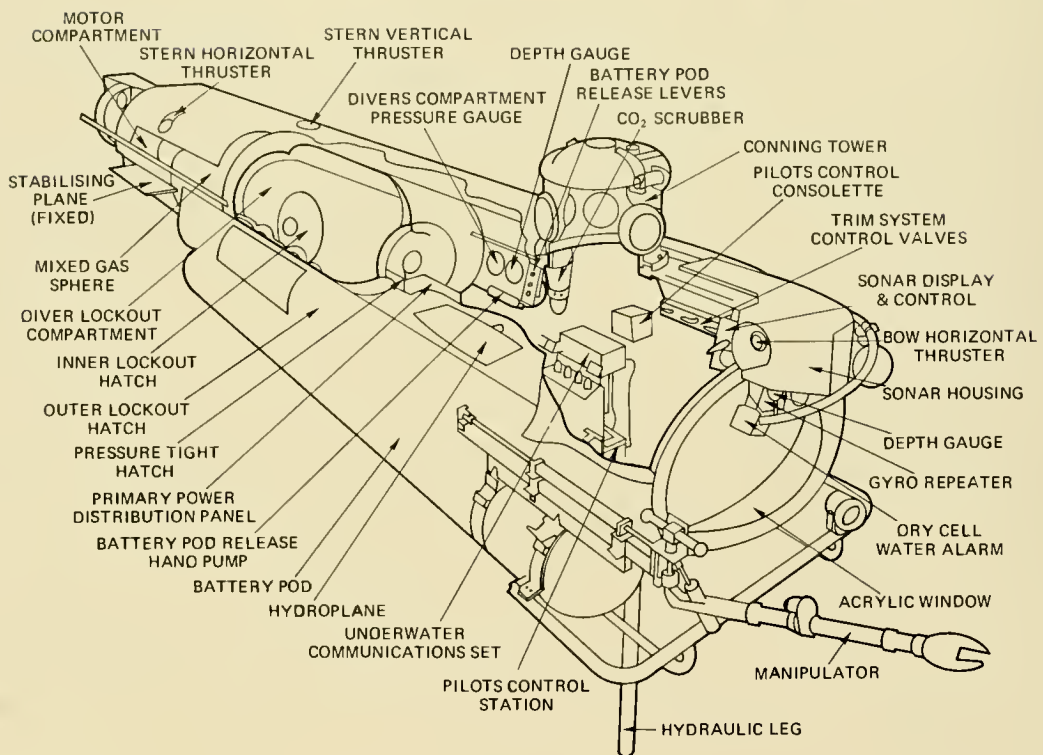
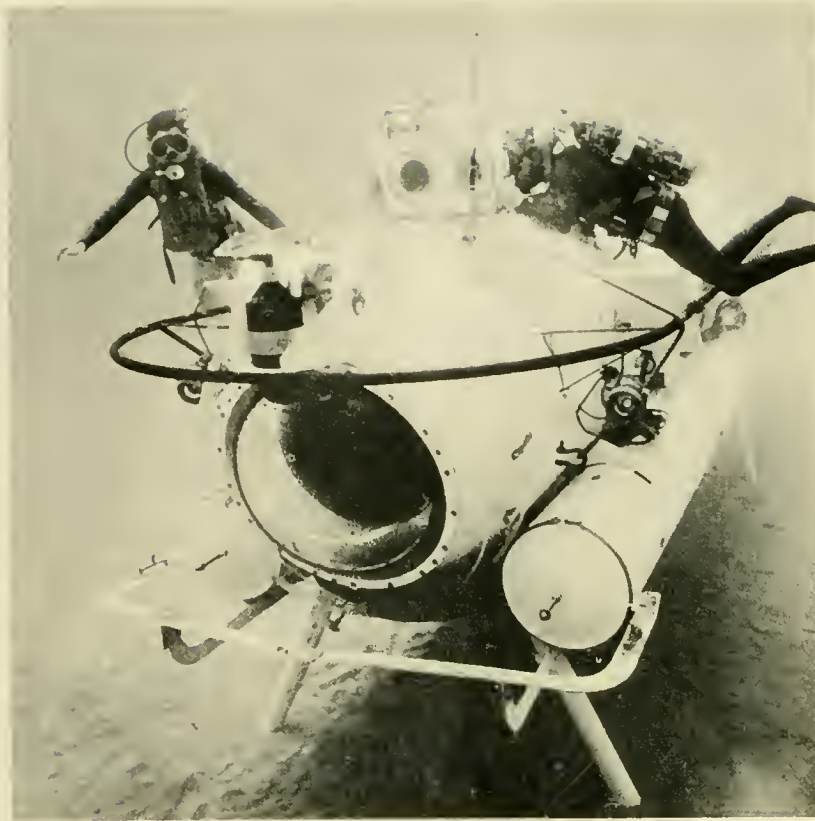

VOL-L1

LENGTH: ..... 32 ft  
 BEAM: ..... 6 ft  
 HEIGHT: ..... 7 ft  
 DRAFT: ..... 5.3 ft  
 WEIGHT (DRY): ..... 13 tons  
 OPERATING DEPTH: ..... 1,200 ft  
 COLLAPSE DEPTH: ..... 1,800 ft  
 LAUNCH DATE: ..... 1973

HATCH DIAMETER: ..... 22 in.  
 LIFE SUPPORT (MAX): ..... 192 man-hr  
 TOTAL POWER: ..... 54 kWh  
 SPEED (KNOTS): CRUISE ..... 1/13-15 hr  
                           MAX ..... 5/0.5 hr  
 CREW: PILOTS ..... 1  
           OBSERVERS ..... 3  
 PAYLOAD: ..... 2000 lb

**PRESSURE HULL:** Cylindrical shape with diver lock-out sphere aft. Hull composed of SA-537 grade A steel to specs. for low temperature operations. Hull is 0.5 in. thick; 54-in. ID and 28.5 ft long. Conning tower is 20 in. high. Hatch to diving compartment is 24-in. diam., diver egress hatch is oblong and 24-in. x 26-in. diam. Helium sphere is of HY-100 steel.

**BALLAST/BUOYANCY:** Internal, fore & aft tanks are pumped dry or flooded to obtain  $\pm 545$  lb (aft) and  $\pm 170$  lb (fwd) buoyancy. Main (surface) buoyancy is attained by venting or blowing main ballast tanks of  $\pm 650$ -lb capacity.

**PROPULSION/CONTROL:** Main propulsion is from a stern-mounted propeller driven by two 10-hp, DC electric motors which have infinitely variable speed control and are reversible. Two horizontal and one vertical thruster assist in maneuvering. Electrohydraulically controlled rudder and bow planes assist in underway maneuvering. An automatic pilot controls rudder angle to  $\pm 3^\circ$ .

**TRIM:** Internal, fore and aft tanks can be differentially filled to obtain up/down bow angles.

**POWER SOURCE:** Three separate banks of 12-V, heavy duty, lead-acid batteries contained in two pressure-resistant battery pods provide 120-VDC main power (44 kWh, 20 hr) and 24-V auxiliary power (10 kWh, 20 hr).

**LIFE SUPPORT:** Gaseous  $O_2$  is carried external to the hull in four tanks of 288-ft<sup>3</sup> total capacity.  $CO_2$  is removed by circulating air through a LiOH (8.2-lb capacity) cannister.  $O_2$  is continuously monitored and  $CO_2$  is monitored periodically with Drager tubes.

**VIEWING:** Six viewports in the conning tower and one in the hatch. Aft compartment has a viewport in the egress hatch and two on each side of the sphere. The forward endcap is fitted with an acrylic plastic dome similar to PC-B.

**OPERATING/SCIENTIFIC EQUIPMENT:** UQC, gyro compass, depth gage, automatic pilot, echo sounder, scanning sonar.

**MANIPULATORS:** One with five degrees of freedom.

**SAFETY FEATURES:** Can blow ballast tanks dry at maximum operating depth. Battery pods are droppable (2,000 lb ea.). Medical lock in diver's compartment.

**SURFACE SUPPORT:** Support ship the same as for PISCES I, II, III.

**OWNER:** Vickers Oceanics Ltd., Barrow-in-Furness, England.

**BUILDER:** Perry Submarine Builders, Riviera Beach, Fla.

**REMARKS:** Operational. Designated by Perry as PC-15.

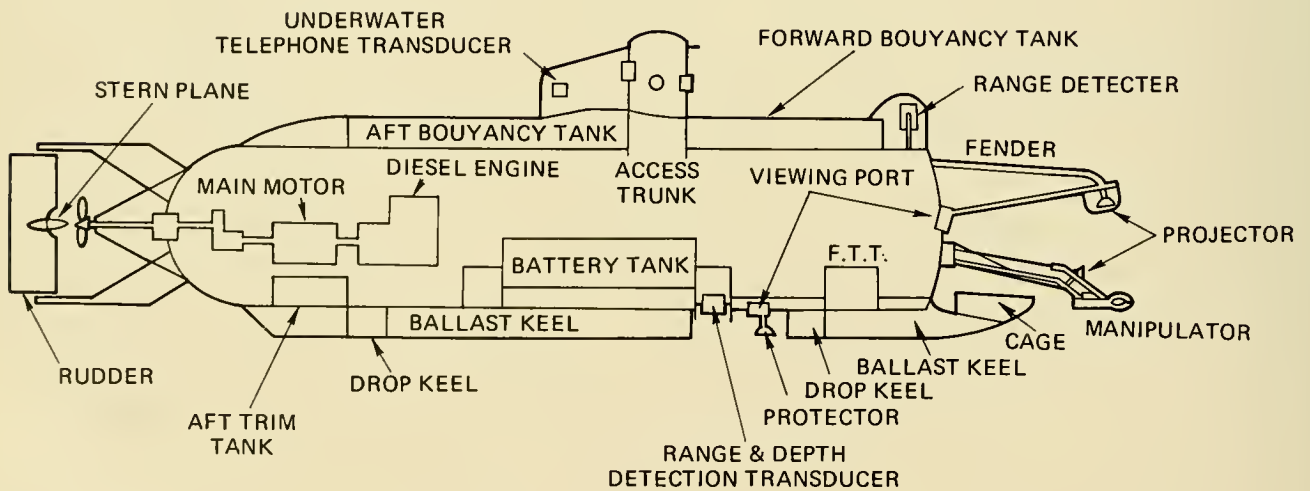

## YOMIURI

LENGTH: ..... 14.5 m  
BEAM: ..... 2.45 m  
HEIGHT: ..... 2.80 m  
DRAFT: ..... 2.20 m  
WEIGHT (DRY): ..... 41 tons  
OPERATING DEPTH: ..... 300 m  
COLLAPSE DEPTH: ..... 519 m  
LAUNCH DATE: ..... 1964

HATCH DIAMETER: ..... 63.5 cm  
LIFE SUPPORT (MAX): ..... 492 man-hr  
TOTAL POWER: ..... 45 kWh  
SPEED (KNOTS): CRUISE ..... 2/10 hr  
MAX ..... 3/6 hr  
CREW: PILOTS ..... 3  
OBSERVERS ..... 3  
PAYLOAD: ..... 1,900 lb

**PRESSURE HULL:** Cylindrical shape with one hemi-spherical endcap (stern) and one spherical mirror plate (bow). Hull material is high tensile steel (46 Hg/mm<sup>2</sup>), cylinder is 2.05-m OD, 16 mm thick and 10.683-m length. Stern endcap is 1.02-m radius, bow endcap is 2.0-m radius.

**BALLAST/BUOYANCY:** The superstructure above pressure hull serves as the surface buoyancy tank with a capacity of 8 tons and is blown by compressed air. A 2-ton-capacity ballast tank is located within the pressure hull which is flooded to descend and pumped dry to ascend.

**PROPULSION/CONTROL:** A 12-kW, 100-rpm motor drives a 3-bladed, stern-mounted propeller for forward propulsion. A vertical rudder and horizontal stern plane aft of the propeller provides vertical and lateral maneuvering.

**TRIM:** Two tanks of 0.4-ton capacity each are within the pressure hull (fore and aft) between which seawater is pumped to obtain desired trim angles.

**POWER SOURCE:** Fifty lead-acid batteries within the pressure hull supply main power to the vehicle. An AC motor generator supplies AC power at 60 Hz, 11 V and 1.5 KVA. Battery recharging is performed at the surface by the submersible's motor generator.

**LIFE SUPPORT:** O<sub>2</sub> is carried in a 46.7-l flask. CO<sub>2</sub> is removed with LiOH scrubbers. During battery charging a fan circulates air in the pressure hull and the gases generated by charging are removed by absorbing them into the (recharging) diesel engine.

**VIEWING:** Two viewports are in the bow of the pressure hull and one is in the bottom. They are 120-mm diam. and 62 mm thick and are made of optically homogeneous glass. Four viewports in the access trunk (conning tower) are 60-mm diam. and 40 mm thick.

**OPERATING/SCIENTIFIC EQUIPMENT:** UQC, obstacle avoidance sonar, echo sounder, transponder.

**MANIPULATORS:** One with six degrees of freedom.

**SAFETY FEATURES:** Breathing masks are provided for each occupant in emergency. Two droppable blocks of 400-kg weight. Skirt under access trunk can be used to exit the vehicle by pressurizing interior.

**SURFACE SUPPORT:** Vehicle is towed and supported at dive site by the 34.57-m (LOA), 235.7-ton ship YAMAMOTO.

**OWNER:** Yomiuri Shimbu Newspaper, Tokyo.

**BUILDER:** Mitsubishi Heavy Industries, Kobe, Japan.

**REMARKS:** Not operating.







# 5

## PRESSURE HULLS AND EXOSTRUCTURES

The first consideration in submersible design is to provide the occupants with a dry, pressure-resistant habitat. Secondly, because volume inside this habitat is generally limited, an external structure is required to carry power sources, motors, and other supporting systems. Thirdly, to prohibit this supporting structure from entanglement or snagging and minimize hydrodynamic drag, a smooth external covering or fairing is indicated. Within these major design considerations must be included pressure hull penetrations to allow occupant entrance/egress and external viewing and penetrations for electrical, hydraulic or mechanical activation and monitoring of external systems.

### PRESSURE HULLS

#### SHAPE

Pressure hull shapes, with few variations, are predominantly spheres or cylinders in various combinations (Table 5.1). A sphere is the most efficient structural form to obtain a minimum weight-to-displacement (W/D) ratio, an ellipse is second, and right circular, cylindrical shell reinforced with frames is last. Two types of end closures have been used on cylindrical pressure hulls: A hemisphere and an ellipsoid. The most efficient from a strength-weight ratio standpoint is

TABLE 5.1 PRESSURE HULL SHAPES AND MATERIALS

Submersible	Depth (Ft)	Hull Shape	Hull Material
HIKINO	20	Sphere	Plastic
GOLDFISH	100	Inverted wedge	Steel
NAUILLETTE (3 Vehicles)	100	Cylinder	Steel
ALL OCEAN INDUSTRIES	150	Cylinder	Ashme steel (Jap.); Plastic conning tower dome
PC3-X	150	Stacked cylinders	A 285 steel
PORPOISE	150	Shoe-like cylinder	Molded fiberglass and resin; Plastic conning tower dome
STAR I	200	Sphere	A 212 Grade B steel
SUBMANAUT (Helle)	200	Elliptical	Plywood with GRP coating
K-250 (12 Vehicles)	250	Cylinder	Steel; Plastic conning tower dome
MINI DIVER	250	Cylinder	Welded steel
SPORTSMAN 300	300	Cylinder	Welded dimetcoated A-36 steel
SUBMARAY	300	Cylinder	Mild steel (boiler plate)
KUMUKAHI	300	Sphere	Plastic
PC-3A1 & 2	300	Stacked cylinders	A 285 steel
NEREID 330	330	Cylinder	Steel
SEA RANGER	600	Cylinder	A 285 C steel
SPORTSMAN 600	600	Cylinder	Welded dimetcoated A-36 steel
SUBMANAUT (Martine)	600	Cylinder	Two 10/30 carbon steel shells with honeycombed reinforcement
TECHDIVER (PC-3B)	600	Stacked cylinders	A 212 steel
ASHERAH	600	Sphere	A 212 Grade B mild steel
BENTHOS V	600	Sphere	A 285 C steel
MAKAKAI	600	Sphere	Plastic
NEMO	600	Sphere	Plastic
PAULO I	600	Cylinder	A 212 B steel
SURV	600	Cylinder	Mild steel plate conforming to BS 1501/1518 (British)
KUROSHIO I	650	Sphere	Steel
KUROSHIO II	650	Cylinder	Soft steel (SM41) (Japanese)
NEREID 700	700	Cylinder	Steel
PC-8	800	Cylinder and Cone	Low temperature carbon steel; Plastic bow dome
SHELF DIVER	800	Cylinder	SA 212 Grade B firebox quality steel
YDMIURI	972	Cylinder	High tensile (46 Hg/mm <sup>2</sup> ) steel
MERMAID	984	Cylinder	High tensile steel (St 53.7) (West German)
HAKUYO	984	Cylinder	High tensile steel NS46 (Japan Defence Agency standard)
TOURS 64 & 66	984	Cylinder	Class G 36 high tensile steel (West German)
GUPPY	1000	Sphere	HY-100 steel
NEKTON A	1000	Cylinder	A 212 mild steel
NEKTON B & C	1000	Cylinder	A 515 mild steel
SEA-RAY	1000	Cylinder	Steel
JOHNSON SEA LINK	1000	Sphere & Cylinder	Plastic (sphere); Aluminum (cylinder)
SNOOPER	1000	Cylinder	A 212 mild steel
PS-2	1025	Cylinder and Cone	A 516 Grade 70 steel; Plastic bow dome
PC-14	1200	Cylinder and Cone	A 516 Grade 70 steel; Plastic bow dome
STAR II	1200	Sphere	HY-80 steel
AQUARIUS	1200	Cylinder	A 516 Grade 70 steel; Plastic bow dome
PISCES I	1200	Sphere	Algoma 44 steel
VDL-LI	1200	Cylinder	SA 537 Grade A steel; Plastic bow dome
VASSENA LECCO	1335	Cylinder	
SURVEY SUB I	1350	Cylinder	SA 537 Grade A normalized steel

TABLE 5.1 PRESSURE HULL SHAPES AND MATERIALS (Cont.)

Submersible	Depth (Ft)	Hull Shape	Hull Material
DEEP DIVER	1350	Cylinder	Rolled and Welded T-I steel; SA 212 Grade B steel
SP-350	1350	Ellipse	Forged mild steel
SEA OTTER	1500	Cylinder	A 212 B mild steel
DEEP VIEW	1500	Cylinder	HY-100 steel; Borosilicate glass endcap.
SP-500 (2 Vehicles)	1640	Cylinder	Steel
SHINKAI	1968	Cylinder and Bi-Sphere	High tensile steel
ARGYRONETE	1970	Cylinder	High yield strength (SMR-type) steel
GRIFFON	1970	Cylinder	Steel
BEN FRANKLIN	2000	Cylinder	Aldur steel and Welmonil steel (West German)
OPSUB	2000	Sphere	HY-80 steel
SDL-I	2000	Cylinder and Bi-Sphere	HY-100 steel
BEAVER	2000	Cylinder and Bi-Sphere	HY-100 steel
DEEP JEEP	2000	Sphere	A 225 B steel
DEEPSTAR 2000	2000	Cylinder	HY-80 steel
STAR III	2000	Sphere	HY-100 steel
AUGUSTE PICCARD	2500	Cylinder	Aldur 55/68 cylinder; Aldur 55 end caps (West German)
PISCES II & III	3000	Sphere	A 242 steel
DSRV-1	3500	Tri-Sphere	HY-140 steel
DEEPSTAR 4000	4000	Sphere	HY-80 steel
DSRV-2	5000	Tri-Sphere	HY-140 steel
TURTLE	6500	Sphere	HY-100 steel
SEA CLIFF	6500	Sphere	HY-100 steel
PISCES IV	6500	Sphere	HY-100 steel
PISCES V	6500	Sphere	HY-100 steel
PISCES VI	6500	Sphere	HY-100 steel
DOWB	6500	Sphere	HY-100 steel
DEEP QUEST	8000	Bi-Sphere	18% Ni 200 KSI grade Maraging steel
SP-3000	10082	Sphere	Vascojet 90 steel
ALVIN	12000	Sphere	Titanium 621.08
FNRS-2	13500	Sphere	Ni-Cr-Mo cast steel
FNRS-3	13500	Sphere	Ni-Cr-Mo cast steel
ALUMINAUT	15000	Cylinder	Aluminum alloy 7079-T6
DEEPSTAR 20000	20000	Sphere	HY-140 steel
TRIESTE II	20000	Sphere	HY-120 steel
TRIESTE	36000	Sphere	Ni-Cr-Mo forged steel (Krupp)
ARCHIMEDE	36000	Sphere	Ni-Cr-Mo forged steel

the hemisphere. Figure 5.1 shows the types of combination and constructions reportedly used to date. To a depth of 2,500 feet the cylinder with hemi-heads dominates, and the sphere is secondary. The remaining vehicles in this depth range are a combination of cylinders and spheres and an inverted wedge and ellipse. Below 2,500 feet only one (*ALU-*

*MINAUT*) out of 22 vehicles uses a cylinder with hemi-heads; the rest employ spheres.

The spherical pressure hull is the most weight efficient geometry but is least amenable to efficient interior arrangements. The cylinder provides an efficient utilization of internal volume but is geometrically inefficient with respect to W/D as is a sphere. As

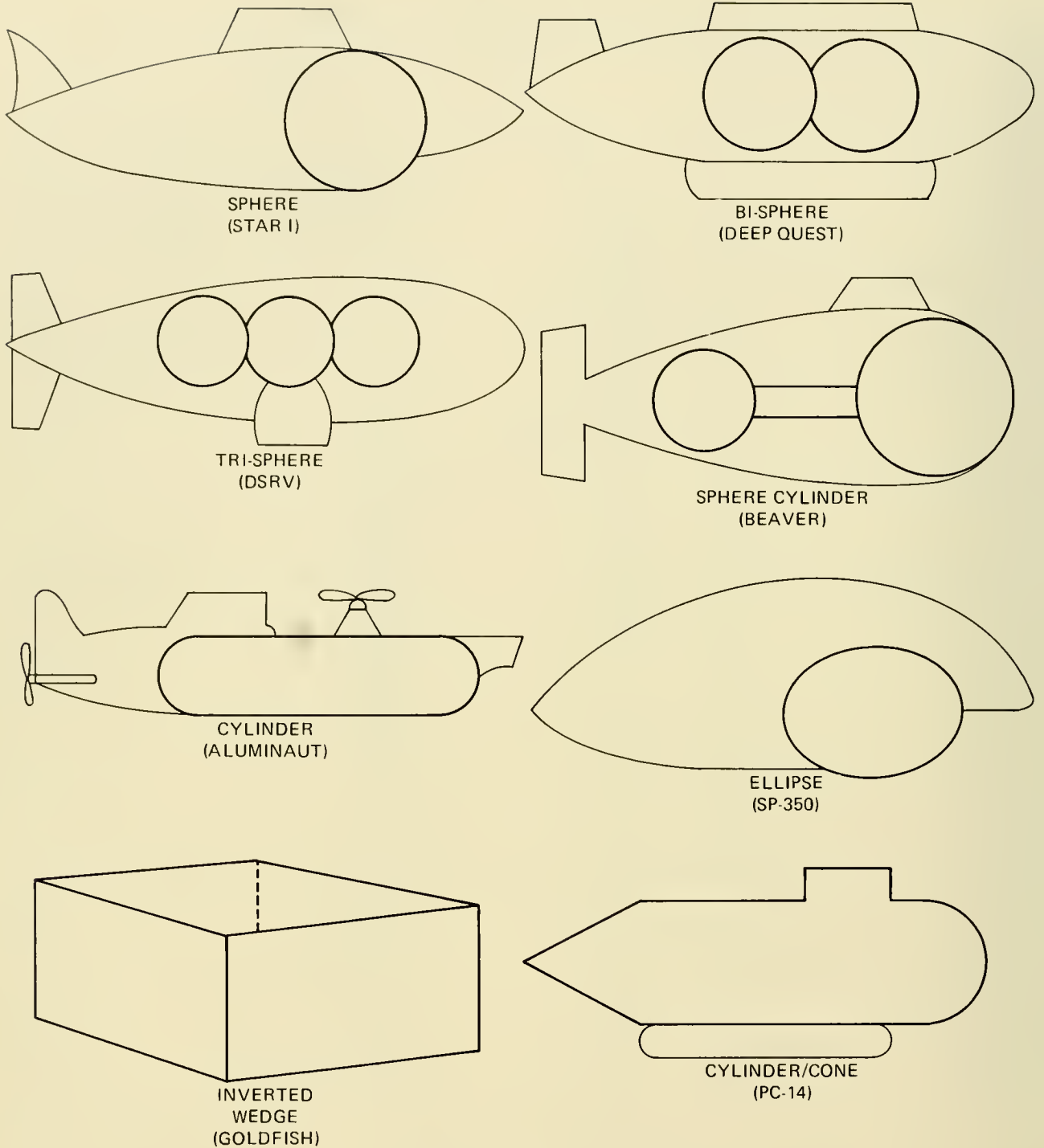

Fig. 5.1 Basic pressure hull shapes.

depth increases the cylinder must be strengthened by frames and thereby weight is added to the detriment of the W/D ratio. An example of W/D ratio as related to shape and sphericity (in this case  $8\frac{1}{8}$ -inch deviation from the nominal radius) in an 8-ft-diam-

eter sphere is presented in Table 5.2. Table 5.3 lists the relative major advantages and disadvantages of three basic configurations. It is important to note that introduction of lightweight materials into pressure hulls permits greater operational depths while

TABLE 5.2 POTENTIAL PRESSURE HULL CONFIGURATIONS AND W/D RATIOS CONSIDERED FOR THE DSRV. [FROM REF. (1)]



Material	Shape	Weight/Displacement		
		Near Perfect	$\Delta g = 1.8$ in. Stress-Relieved	$\Delta g = 1.8$ in. As Fabricated
HY-130(T)		0.39	0.46	0.51
		0.40	--	--
		0.41	0.48	0.53
		0.42+	0.49+	0.54+
		0.43	--	0.49
		0.42	--	0.47

TABLE 5.3 ADVANTAGES AND DISADVANTAGES OF SUBMERSIBLE PRESSURE HULL SHAPES

	Advantages	Disadvantages
Sphere	<ol style="list-style-type: none"> <li>1. Most favorable weight to displacement ratio</li> <li>2. Thru-hull penetrations easily made</li> <li>3. Stress analyses more accurate and less complex</li> </ol>	<ol style="list-style-type: none"> <li>1. Difficult interior arrangements</li> <li>2. Large hydrodynamic drag</li> </ol>
Ellipse	<ol style="list-style-type: none"> <li>1. Favorable weight to displacement ratio</li> <li>2. More efficient interior arrangements</li> <li>3. Thru-hull penetrations easily incorporated</li> </ol>	<ol style="list-style-type: none"> <li>1. Fabrication expensive</li> <li>2. Structural analysis difficult</li> </ol>
Cylinder	<ol style="list-style-type: none"> <li>1. Fabrication easiest</li> <li>2. Most efficient interior arrangements</li> <li>3. Low hydrodynamic drag</li> </ol>	<ol style="list-style-type: none"> <li>1. Least efficient weight to displacement ratio</li> <li>2. Stiffeners (internal) required at great depths (1,000-ft)</li> <li>3. Structural analyses techniques difficult for cylinder thru-hull penetrations</li> </ol>

maintaining a lower or equal W/D ratio. Such is the case with the aluminum *ALUMINAUT* and *ALVIN*. The latter increased its operating depth from 6,000 to 12,000 feet, and also decreased its W/D ratio by replacing its HY-100 steel hull with titanium.

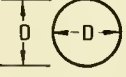
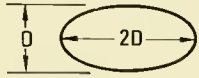
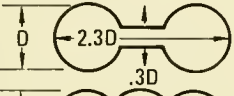
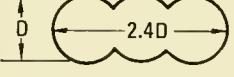
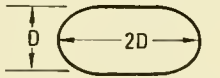
Two major factors controlling both pressure hull shape and material are the vehicle's projected maximum operating depth and payload. Both values are derived from the basic role the vehicle is expected to perform and within what range of ocean depths. Ar-

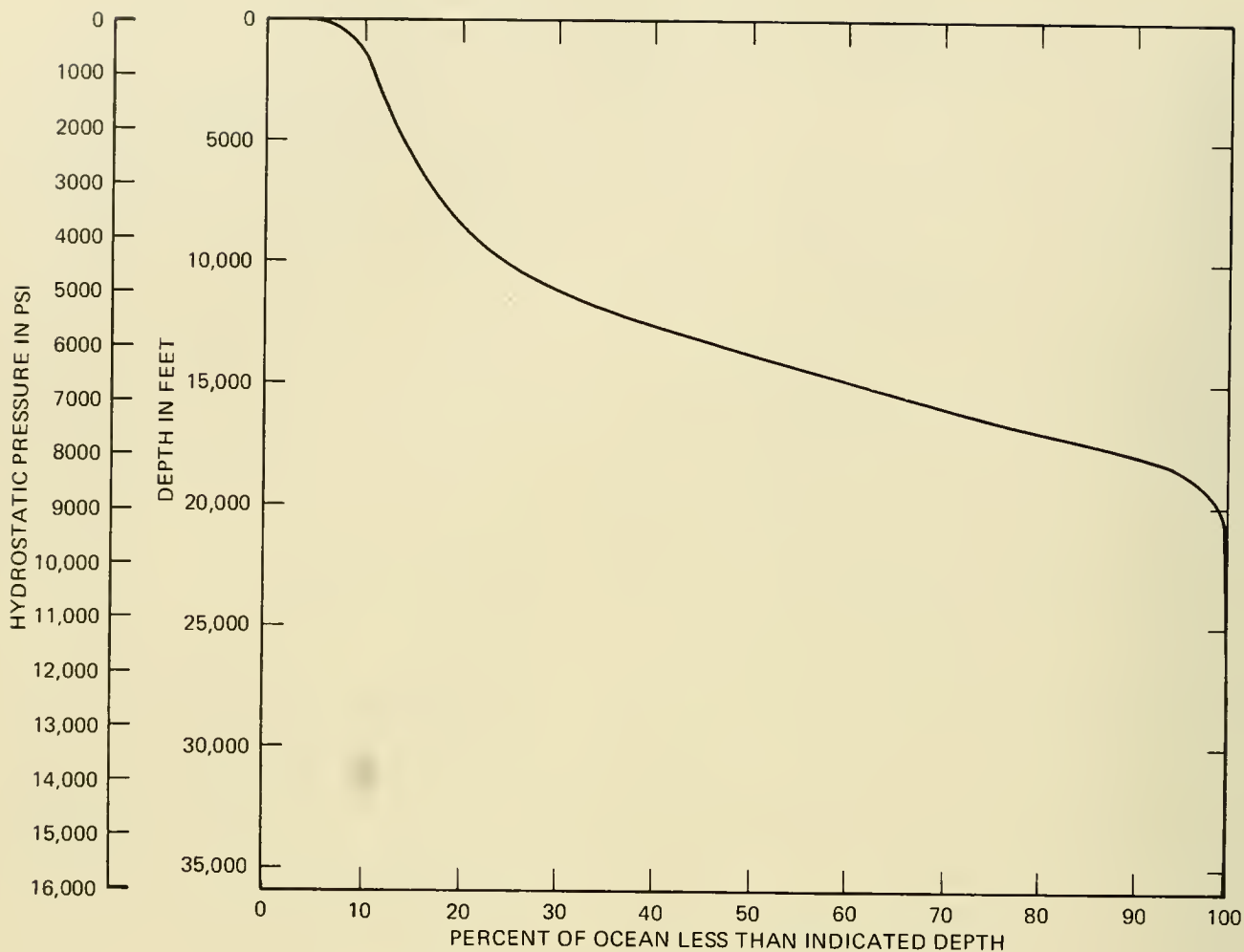

Fig. 5.2 Percent of ocean bottom at various depth levels.

iving at an operating depth is not quite as easy as it may appear, especially if the vehicle is intended to be leased or used by a variety of customers. While this problem has somewhat diminished owing to a lack of interest (funds) on the part of potential deep-diving customers, it still persists owing to varying depths of interest among scientific and commercial users, the relatively unknown location and quantity of potential marine resources and the increasing vehicle cost with increasing depth capability.

The owner must weigh all of the above factors to arrive at a useful, economic depth of operation. Unfortunately, the ocean bottom does not provide much assistance. Figure 5.2 presents the percent of the ocean bottom vs. depth, as well as the number of

submersibles within various depth ranges. Approximately 8 percent of the ocean bottom is located at continental shelf depths (0-600 feet). From this depth downward the percentage of bottom attainable increases slowly at the cost of greatly increased depth capability. For example, the 1,200-ft *STAR II* can reach 10 percent of the ocean bottom, while the far more complex and expensive 8,000-ft *DEEP QUEST* does not quite double this percentage. Unquestionably, the least gain in percentage of accessible bottom is from 20,000 feet to 36,000 feet, where the percentage of increase is from 98 to 100, respectively. The depth decision was particularly difficult in the early sixties when the incipient field offered few clues to depth of interests; from the late sixties on a trend

towards shallower, continental shelf-capable vehicles was brought about by the newly emerging offshore oil customer. As this customer goes ever-deeper in his quest for petroleum, the problem of defining a depth limit to an oil industry-oriented vehicle becomes increasingly difficult. In essence, the selection of an optimum depth is difficult, and to err on the side of excess may spell the difference between profit or loss for the commercial lessor.

## MATERIALS

Pressure hull materials are metallic and non-metallic; regardless, all physical properties must be characterized and taken into account during the process of material selection in order to provide a design which will perform successfully in the ocean environment. Such materials and their welds or bonding materials must be characterized to account for the following during the material selection phase:

**Corrosion:** The deterioration of a metal by chemical or electrochemical action within its environment,

**Stress-Corrosion Cracking:** Failure by flow propagation under combined action of a flaw and tensile stress,

**Low Cycle Fatigue:** Fracture under fluctuating stresses having a maximum value less than the tensile strength of the material. (Low cycle is less than 100,000 fluctuations in pressure),

**Creep:** Time dependent plastic deformation (permanent change in size or shape of a body) occurring under stress,

**Stress Relief Embrittlement:** Reduction in the normal ductility of a metal when it is heated to a suitable temperature and then slowly cooled to reduce residual stresses,

**Brittle Fracture:** Fracture with little or no plastic deformation which occurs in some metals at low temperatures,

**High Strength to Density Ratio:** (defined previously),

**High Ductility:** The ability to deform plastically without fracturing,

**Fracture Toughness:** The ability to deform plastically in the presence of a thru-hull crack without catastrophic propagation and failure,

**Weldability:** Suitability of a metal for welding under proper conditions,

**Formability:** The relative ease with which a metal can be shaped through plastic deformation, and

**Reproducibility:** The process of production being such that the material can be sequentially produced to closely approximate its predecessor in all properties.

Equally important are the developmental and fabrication cost and the availability of the candidate material.

Submersible pressure hull materials consist of steel, aluminum, titanium, acrylic plastic, glass and wood (Table 5.1). Steel, at 90 percent, constitutes the overwhelming majority of pressure hulls—primarily because of the high degree of knowledge available to the designers and fabricators and the large amount of experience with respect to its performance in the ocean.

The technical literature devoted to pressure hull material candidates and their characteristics is voluminous. Almost all deal with materials for deep (greater than 1,000 ft) diving, with too little attention paid to shallow diving. This is unfortunate in view of the present trend toward shallow, rather than deep, submersibles. One might theorize that sufficient is known of materials for shallow vehicles, but this is not always the case. For example, a portion of *DEEP DIVER's* pressure hull consists of a grade of T-1 steel which, when a flaw is present in a tensile stress field, is subject to brittle fracture at low temperatures. While this steel might be acceptable in certain ocean areas, or by employing design and fabrication techniques which would preclude tensile stresses and minimize the flaw size, it was not acceptable to the U.S. Navy (2). They declined material certification because of the lack of material characterization (fracture mechanics properties) and the potential existence of flaws and residual tensile stresses in weldments.

The reason for the trend toward high strength steels is their high yield stress, acceptable fatigue and fracture properties and fabricability.

At the very least, submersible development and operations in the decade of the

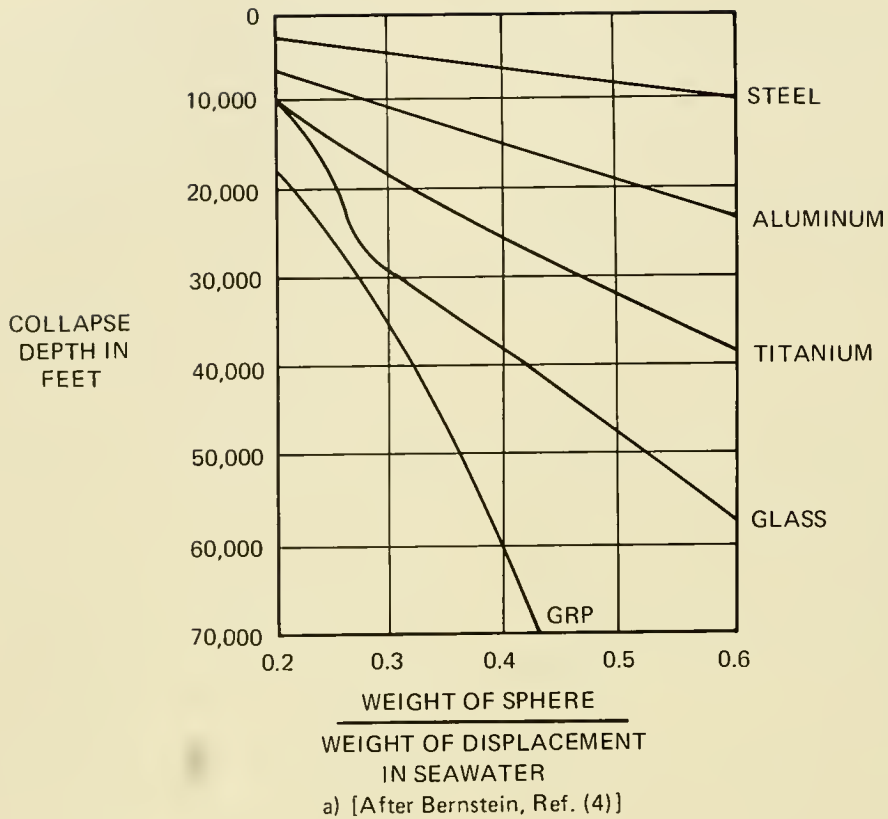

QUALITATIVE COMPARISON OF FACTORS INFLUENCING  
SELECTION OF MATERIALS FOR HYDROSPACE VEHICLES

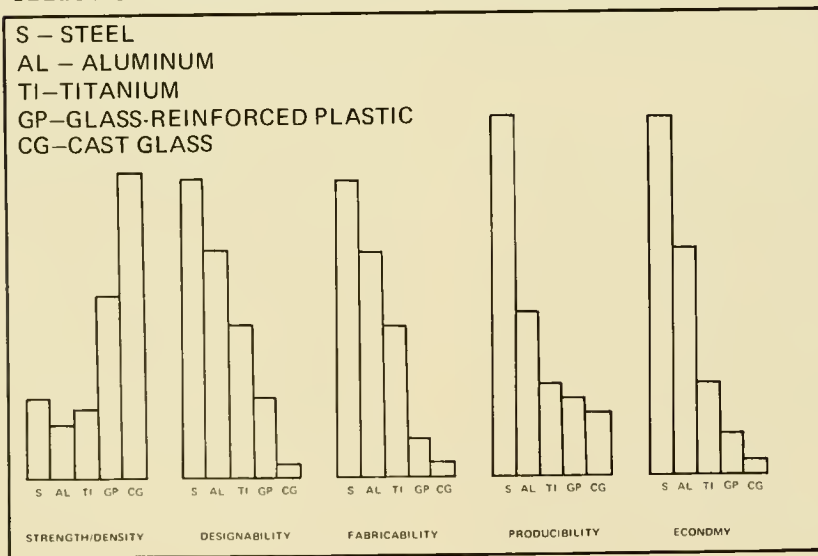

Fig. 5.3 a) W/D ratio vs. collapse depth of five material candidates for spherical pressure hulls.  
b) Qualitative comparison of pressure hull materials.



sixties put to rest a number of "can'ts" and "undesirables" in regard to materials for pressure hulls. Let us look at two examples:

1. Aluminum was considered by many to be unacceptable as a pressure hull material because it is unweldable and subject to stress-corrosion cracking. However, *ALUMINAUT*'s designers simply bolted its cylindrical sections and hemispherical endcaps together, and placed sacrificial anodes at various locations about the hull; *ALUMINAUT* performed successfully for several years before its retirement in 1970 (3).
2. Bernstein (4) relates that tests at the Naval Applied Science Laboratory in early 1965 disclosed that the titanium alloy Ti-721 was also susceptible to stress-corrosion at high tensile stress levels, but in 1973 *ALVIN* was fitted with a titanium pressure hull using an alloy insensitive to this problem.

A major innovation in pressure hull materials grew out of the introduction of acrylic plastic viewports by Piccard, which has since led to complete pressure hulls of this material. Dr. Jerry Stachiw, the leader in the research and development efforts leading to the acceptance of acrylic plastic by the U. S. Navy, presents a quasi-technical account of the development and fabrication of acrylic pressure hulls from *NEMO* through to the *JOHNSON SEA LINK* (5). More technical and detailed accounts are presented in references (6-10).

Equally innovative and promising is the introduction of glass as an endcap for *DEEP VIEW*. This application grew out of the early work with *HIKINO* under Mr. Will Forman at China Lake, California. Though *DEEP VIEW* is only certified to 100 feet, its design is experimental for the purpose of overcoming some of glass's shortcomings, such as its brittleness, high sensitivity to surface abrasion, and considerable strength degradation at joints (11). The advantages of both acrylic plastic and glass are a low weight/displacement ratio and panoramic visibility. Figure 5.3a shows the variations of collapse depth for spherical hulls of various materials against W/D ratio; the advantages in this area are clearly in favor of glass and glass reinforced plastic (GRP) for deep diving.

While some materials are clearly favored in some areas, others offer advantages of their own which must be weighed against the favorite. Figure 5.3b compares five candidate materials and their advantages and disadvantages.

While titanium, glass and GRP will undoubtedly see a future in manned submarines, provided the material development cost is not prohibitive, steel continues to be the prime candidate; according to Ballinger and Garland (13) the best of these steels are HY-100, HY-140, HP9-4-20 and 18 percent nickel maraging steel, the chemical analyses and mechanical properties for which are given in Table 5.4; both are taken from the same report.

TABLE 5.4 CHEMICAL ANALYSIS OF STEELS FOR SUBMERSIBLE VEHICLE PRESSURE HULLS (FROM REF. (13))

	C	Mn	P	S	Si	Ni	Cr	Mo	V	Co	Ti	Al
HY-100	0.20 Max	0.10/0.40	0.25 Max	0.25 Max	0.15/0.35	2.25/3.50	1.00/1.80	0.20/0.60	0.03 Max	—	0.02 Max	—
HY-140	0.12 Max	0.60/0.90	0.01 Max	0.01 Max	0.20/0.35	4.75/5.25	0.40/0.70	0.30/0.65	0.05/0.10	—	0.02 Max	—
HP9-4-20	0.17/0.23	0.20/0.30	0.01 Max	0.01 Max	0.10 Max	8.5/9.5	0.65/0.85	0.90/1.10	0.06/0.10	4.25/4.75	—	—
18% Ni Maraging	0.03 Max	0.10 Max	0.01 Max	0.01 Max	0.10 Max	17.50/19.00	—	3.50/4.50	—	7.00/8.00	0.05/0.25	0.05/0.15

TYPICAL MECHANICAL PROPERTIES FOR STEELS FOR DEEP SUBMERSIBLE PRESSURE HULLS (FROM REF. (13))

Material	0.2% Offset Yield Strength KSI	Tensile Strength KSI	Charpy V Notch Ft/Lb	K <sub>IC</sub> KSI√in.	Modulus EX 10 <sup>6</sup> psi
HY-100	100	120	>50 @ -120°F	—	30
HY-140	140	155	60 to +120 @ 0°F	>150	30
HP9-4-20	180	215	50 @ 0°F	>150	29
18% Ni Maraging	175/200	190/215	35 @ Room Temp	100/120	20

Only one submersible is known with wood as a pressure hull material, the Helle **SUB-MANAUT**. Stachiw (14) reported tests at the U.S. Naval Civil Engineering Laboratory with mahogany plywood cylinders and, by virtue of its low density (0.016 lb/in.) and a strength to weight ratio better than that of hot or cold rolled low carbon steels, found it to be quite suitable for depths less than 2,000 feet. Remarking on its low cost and easy workability, Stachiw recommends it as a candidate material for individuals or institutions where limited construction budgets prevail.

An equally promising, and unexpected, material is concrete (Fig. 5.4). Using an especially formulated concrete mix, Stachiw (15) tested 16-inch-diameter, 1-inch-thick concrete spheres, with no reinforcement, to destruction and subjected them to long-term pressure. Two hemispheres were joined with 8288-A Epocast furane epoxy after curing for 1 month in a 100 percent humidity room. One puzzling aspect of the tests was that while permeability of the concrete to seawater was low (5 ml/hr at 1,500 psi), the salinity of the water inside the sphere was less than that outside. Although more testing is required to man-rate such materials, Stachiw recommends its use for fixed installations to 3,500 feet where positive buoyancy is required.

## FABRICATION

The joining together of the pressure hull components—hemisphere-to-hemisphere cylinder-to-endcap, etc.—has been accomplished in several ways: Welding, bolting, adhesive bonding, clamping, and retaining rings. Though relatively straight-forward in a metal-to-metal bond, the problem becomes quite complex with bonds such as glass-to-metal.

### Welding:

The majority of submersible pressure hulls are joined together by welding; both the welding material's physical properties and the welder himself are governed by well-defined military or civil (commercial) regulations. The welding material should be the equivalent of the parent (pressure hull) material and stored under exacting conditions

to control moisture content which could generate nascent hydrogen in the weld and thereby weaken it. The U.S. Navy has established MILSPECS which govern welding material and the storage thereof. The American Society of Mechanical Engineers has defined requirements for welding of various pressure vessels for use by the commercial sector.

Similarly, both groups have requirements and tests which the welder must pass and efficiency levels he must maintain. Such tests include welding in different positions such as downhand and overhand, and subjecting the welds to various bending, pulling and impact tests, as well as to X-ray and ultrasonic inspection. In the case of **BEN FRANKLIN**, a dye penetrant system served as an additional test of the welders' efficiency (16).

Fabrication of the **BEN FRANKLIN** hull (Fig. 5.5) employed both welding and bolting techniques, and the checks and treatment during fabrication incorporated the majority of procedures followed in all steel-hulled vehicles. Two European steels, Aldur (77,800

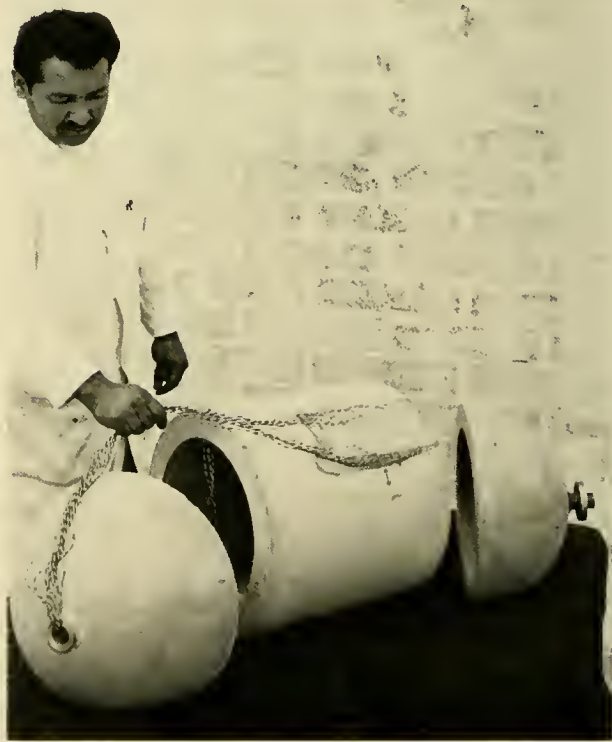

Fig. 5.4 Short cylindrical concrete hull shown prior to epoxy bonding of hemisphere caps onto cylinder section. (NCEL)

psi yield) and Welmonil (71,500 psi yield) were used in the cylinder and hemispherical endcaps, respectively. These possess properties quite similar to HY steels. The cylindrical portion of the hull was fashioned from six sections of rolled steel cold-formed to cylindrical shape in a plane-rolling machine and the longitudinal joint hand-welded. Sixteen stiffener rings were fabricated of Aldur steel and, when finished, placed on a special jig where the cylinders were heated to 200°C and lowered over the ring stiffeners. The rings were welded to the cylinders at an ambient temperature of 150°C. The endcaps were formed of seven orange-peel sections cut out of plate steel and forged to the shape of a hemisphere at 900°C. The seven cylindrical sections and endcaps were tack welded together and then the main circumferential welds made automatically outside and by

hand inside. Brackets and clips were welded at various locations outside the hull for later attachment of ballast tanks, motors and the like. Extra attachment points were included to provide for future growth or modifications of the vehicle. Welding such brackets or clips to the hull after it has been completed should be avoided as it introduces high local residual stresses which, in general, are impractical to stress relieve by heat treatment after the hull has been finished and outfitted.

When all welds were completed and checked, the two sections were stress relieved, or heated, to remove residual stresses in both the parent and weld materials. This procedure consisted of heating the hull to 525°C and holding it there for 3.5 hours (2 minutes for each mm of thickness) and then slowly cooling it in still air.

As described, *BEN FRANKLIN's* endcaps

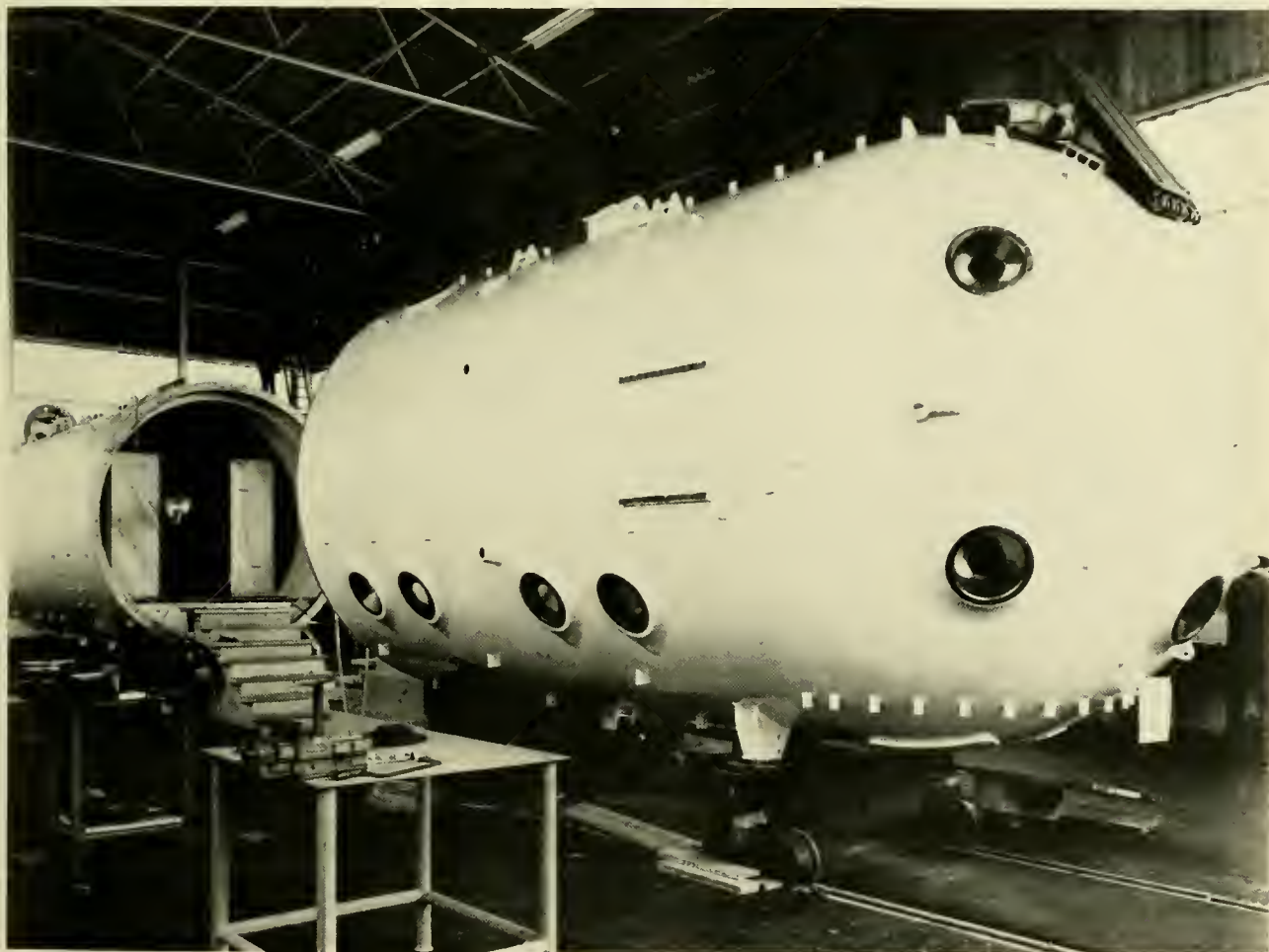

Fig 55 *BEN FRANKLIN's* pressure hull. (Grumman Aerospace)

were formed by the welding of orange peel sections to form a hemisphere; not all hemispheres are formed in this manner. *ALVIN*'s spherical pressure hull is composed of two hemispheres, both of which were originally flat, steel discs subsequently placed on a spinning table while a hydraulically-powered roller applied pressure over a form to shape the disc into the desired hemisphere (Fig. 5.6). This same procedure, hot spinning, was used to form the hulls of *DEEP QUEST*, the *DSRV*'s, *GUPPY*, and several other U.S. submersibles.

Following another complete inspection of

the welds of *BEN FRANKLIN*, over 2,000 measurements were made to check hull straightness and circularity. Radius tolerance is  $\pm 5$  mm of the theoretical radius at any point; straightness tolerance is  $\pm 2.5$  mm from a straight line between any two adjacent stiffeners. Both sections were sandblasted and painted with two coats of zinc-based epoxy and one coat of paint.

The two sections, flanges welded in each and machined to 1.25-inch thickness, were bolted together with 60 bolts. A shoulder projects from the aft section into the forward section to transfer shear loads at the joint.

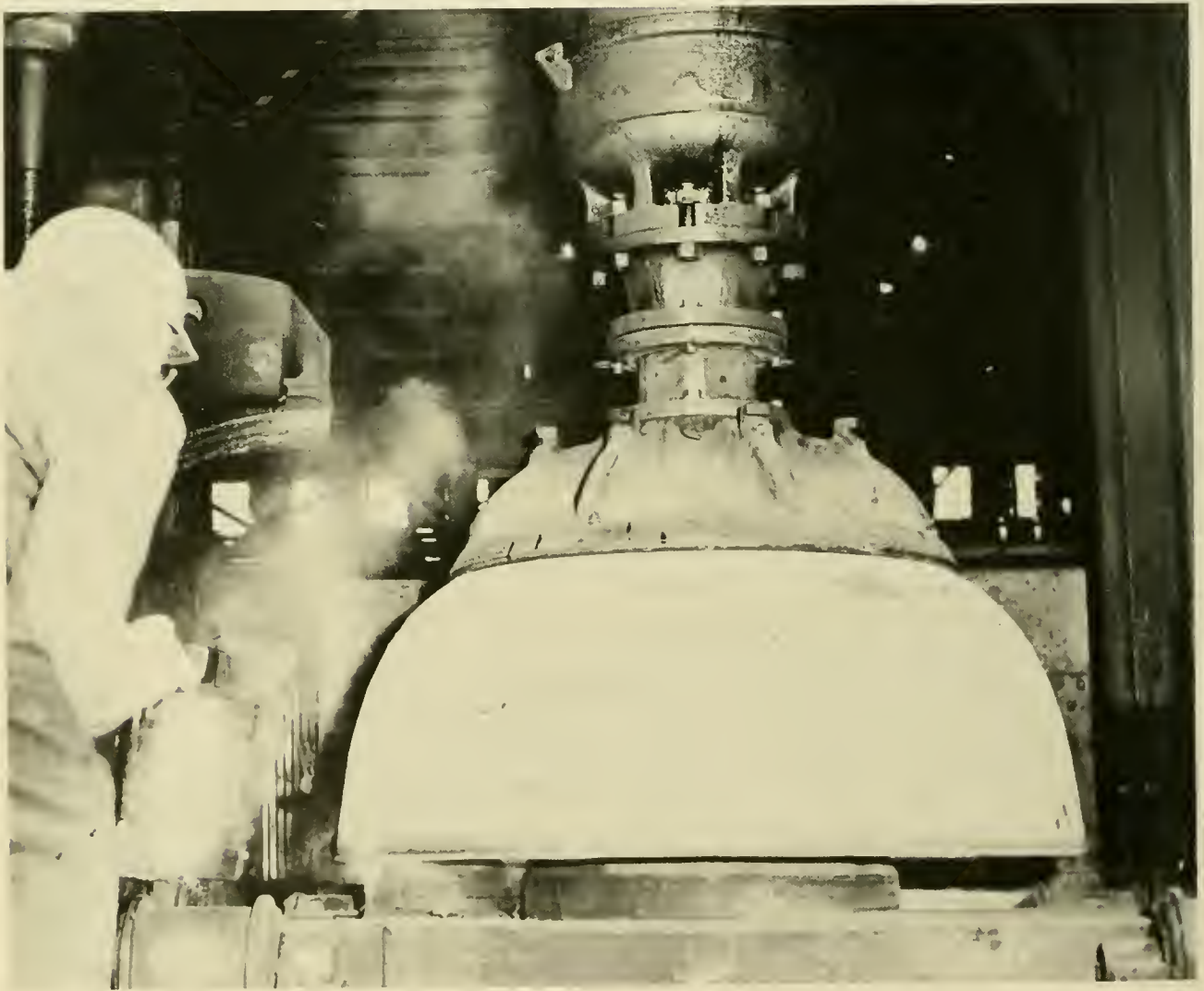

Fig. 5.6 Hot spinning *ALVIN*'s pressure hull. Roller at left of picture applies pressure while the steel sphere is spun and maintained at a high temperature. (WHOI)

An "O" ring groove was machined in the forward flange to hold a 9-mm-diameter neoprene ring which provides a watertight seal at low pressure. Metal-to-metal contact of the flanges during deep submergence serves as a high pressure seal. *BEN FRANKLIN* was bolted together to accommodate future plans for a diver lock-out module which could replace the original aft section. The finished hull prior to bolting is shown in Figure 5.5.

#### **Bolting:**

Where the pressure hull material is essentially non-weldable it may be bolted together. *ALUMINAUT* serves as an example. *ALUMINAUT*'s pressure hull (Fig. 5.7) is composed of 11 cylinders and 2 hemispherical endcaps. Thirteen huge aluminum ingots (17,000 lb each) were cast as rectangles and then heated and forged under hydraulic presses into a cylindrical shape. The centers were then punched out and the partially shaped pieces transferred to a ring rolling machine and rolled to their final contour; these and the endcaps were later machined

to critical tolerances of 32-microinch finish on all joint faces (17). The pieces, after sandblasting, received four coats of different colored polyurethane paint 0.002-inch thick to show surface scratches. Flanges were then bolted to each cylinder and then bolted together. The selection of bolts and the bolting procedures were practically laboratory controlled. After initial jig drilling, bolt holes were reamed to tolerances of 0.0005 inch or better in roundness and 0.001 inch for size. Some 400 bolts are used in the hull; each bolt and bolt hole was measured individually and matched to each other for the best fit. Each bolt was then shrink-fitted by cooling it in liquid nitrogen at  $-320^{\circ}\text{F}$  prior to insertion and allowed to expand to a degree where no bolt diameter exceeded hole diameter by more than twelve ten-thousandths of an inch. In this case, there was no intention of later unbolting sections as with *BEN FRANKLIN*.

#### **Adhesive:**

On plastic-hulled vehicles neither bolting nor welding is feasible; hence, an adhesive or



Fig. 5.7 *ALUMINAUT*'s pressure hull. (Reynolds Submarine Services)

glue is used. In the case of *NEMO*, 12 spherical pentagons were made by first sawing discs from a flat sheet of Plexiglas G (Rohm & Haas), and then molding the flat disc to the desired spherical shape. Each sphere was then machined to a pentagonal shape. The pentagons were then placed in an assembly jig (six at a time) until two quasi-hemispheres were formed which were then bonded to each other (Fig. 5.8). In bonding operations the pentagons were spaced 0.125 inch apart with plastic spacers and the joint on each side was covered with an adhesive backed aluminum foil (Scotch Brand No. 425). Swedlow's proprietary casting material SS-6217 was used to bond the pentagons together (18). Bubbles, visible in the bonding cement, were removed by machining or drilling and, after an annealing process, the areas to be repaired were filled with SS-6217.

Two conical steel (cadmium plated 4130 steel) end plates are at the top and bottom of the sphere; the former is the hatch and the latter is for thru-hull penetrations. These are held in place by retaining rings.

#### Clamping:

The present *TRIESTE II* has two hemispheres, manufactured by Hahn and Clay, of a high yield steel (HY-120); the weldability of this material is unknown. Consequently, a circumferential flange was machined along the outer edge of each hemisphere; the two sections were aligned by means of an alignment groove. Then a bolted "C" type clamping ring was fitted over both flanges around the entire sphere to hold both halves together (Fig. 5.9). An O-ring outboard of the alignment groove serves as a low pressure seal. The original Krupp sphere was of three sections (two disk-like endcaps and a central cylinder-like section). The three sections were originally bonded together by epoxy resin, but this glue failed, and the sphere was subsequently held together by six metal bands gripping two metal rings top and bottom.

#### Glass-to-Metal:

A special situation exists with joining glass to metal as in *DEEP VIEW*. The softness of glass, its low Young's Modulus and high Poisson's ratio, makes it difficult to mate with metals which generally have the

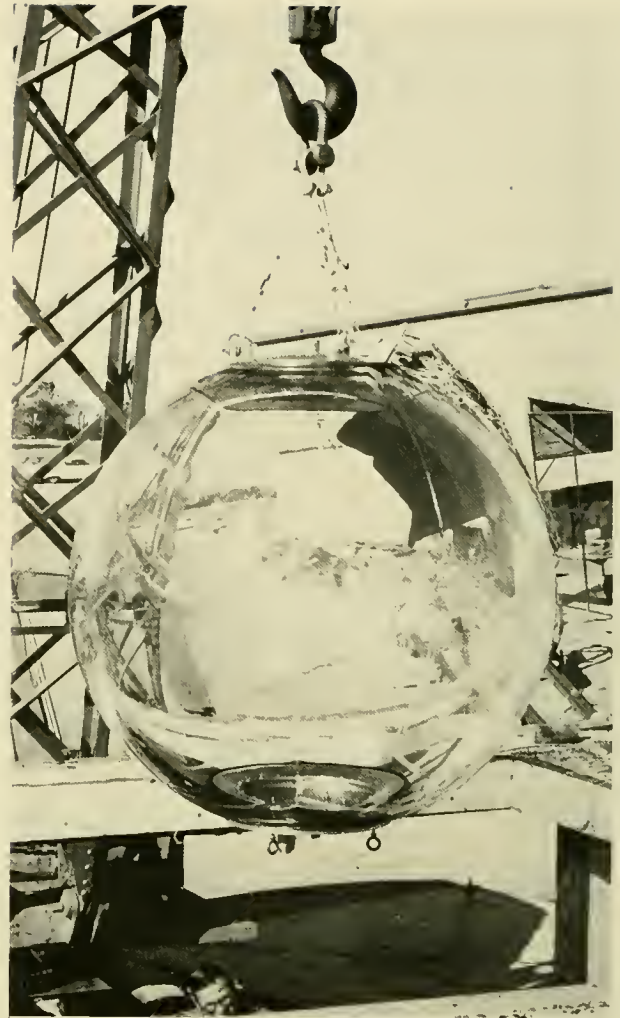

Fig. 5.8 The plastic hull of *NEMO* after bonding together of twelve spherical pentagons. (NCEL)

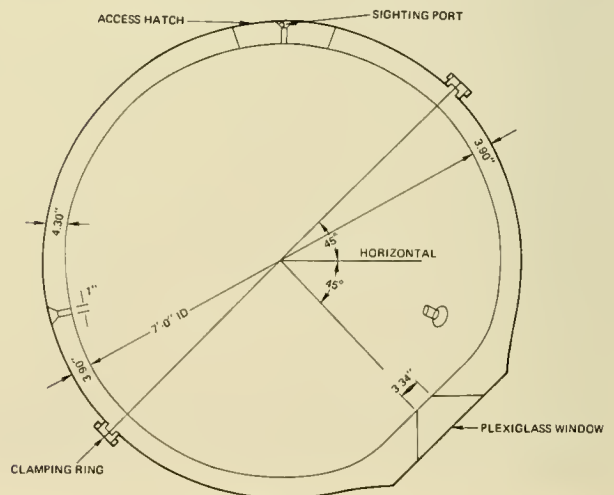

Fig. 5.9 Centerline section of *TRIESTE II*'s pressure hull. Note tapered reinforcement at viewport.

opposite characteristics (19). Following many trials and testing by W. R. Forman and his associates at NUC, the edge of the hemisphere joining the steel cylindrical pressure hull was ground round to a radius equal to one-half the shell thickness and a neoprene-coated nylon gasket was fitted between the two (Fig. 5.10). This configuration and very careful fitting eliminated edge failures. A titanium retaining ring holds both glass endcap and steel cylinder together.

## HULL PENETRATIONS

Unlike large military submarines, a submersible's interior is quite limited, and items such as batteries and motors are frequently located outside the pressure hull. All submersibles have one or more thru-hull penetrations which serve as: Personnel access hatches, viewports, and hydraulic, electric, and mechanical penetrations.

If such openings are small in comparison to the pressure hull dimensions, the stress level in the area adjacent to the opening is not significantly altered. If the opening is comparatively large, as are hatches and viewports, reinforcement of the area immediately adjacent to the opening is required (Fig. 5.11). In general a tapered reinforcement is used, especially for viewport penetrations. Such reinforcement can be of considerable thickness; for example, *TRIESTE's* Terni sphere ran from a thickness of 3.5 inches to 6 inches around the viewports. Stresses around viewports have been studied and results for the *ALVIN* viewports are presented in reference (20). In the case of hatches, it is possible to machine both hatch and hull mating surfaces to ensure that the hatch acts as an integral part of the hull and thereby minimizes the thickness of the reinforcement (21); for this reason no reinforcements are seen around *TRIESTE's* access hatch.

The majority of penetrations in cylindrical pressure hulls are found in the endcap hemispheres, the reason being that most of the external equipment is located adjacent to the enclosures. When large penetrations are required and present major structural discontinuities, such as the intersection of two spheres or two cylinders, the designer must

employ generalized structural analysis computer programs, *i.e.*, finite element or finite difference, to determine the configuration and size of the reinforcement. A final verification of the stress magnitude and displacement is obtained by placing the entire hull in a chamber where the pressure is raised to various levels and measuring the values experimentally. However, large submersibles of the *BEN FRANKLIN* variety are too large for this procedure; hence, experimental stress verification data is obtained during the submersible's sea trials. A standard rule of the ASME Pressure Vessel Code for externally pressurized structures is that the reinforcement shall consist of 100 percent of the material taken from the hull. For example, if 2-inch-diameter pipe is to pass through a 1-inch-thick hull, then the 3.14 cubic inches of material must be replaced as reinforcement

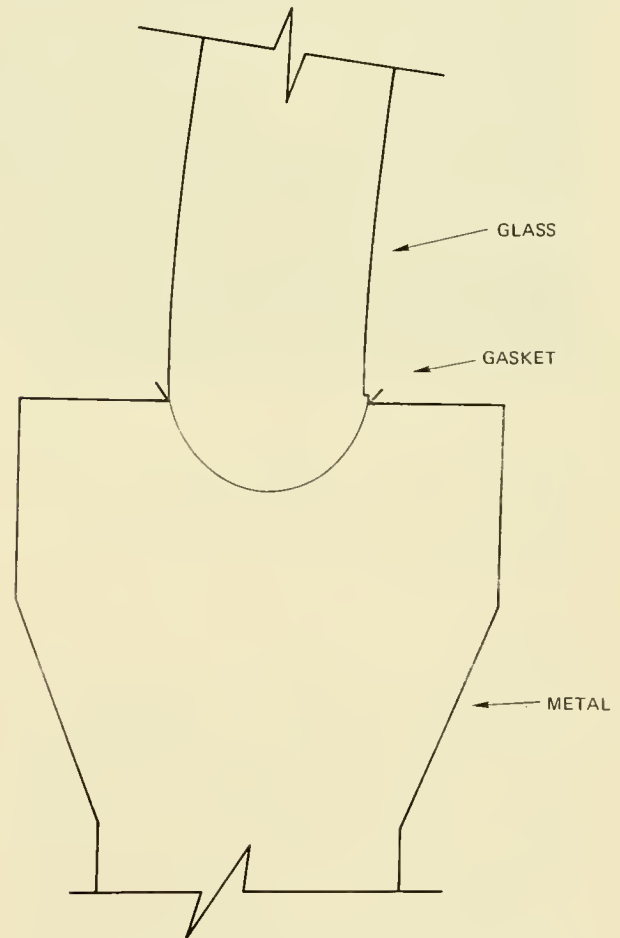

Fig. 5.10 Cross section of glass to metal joint. [From Ref. (19)]

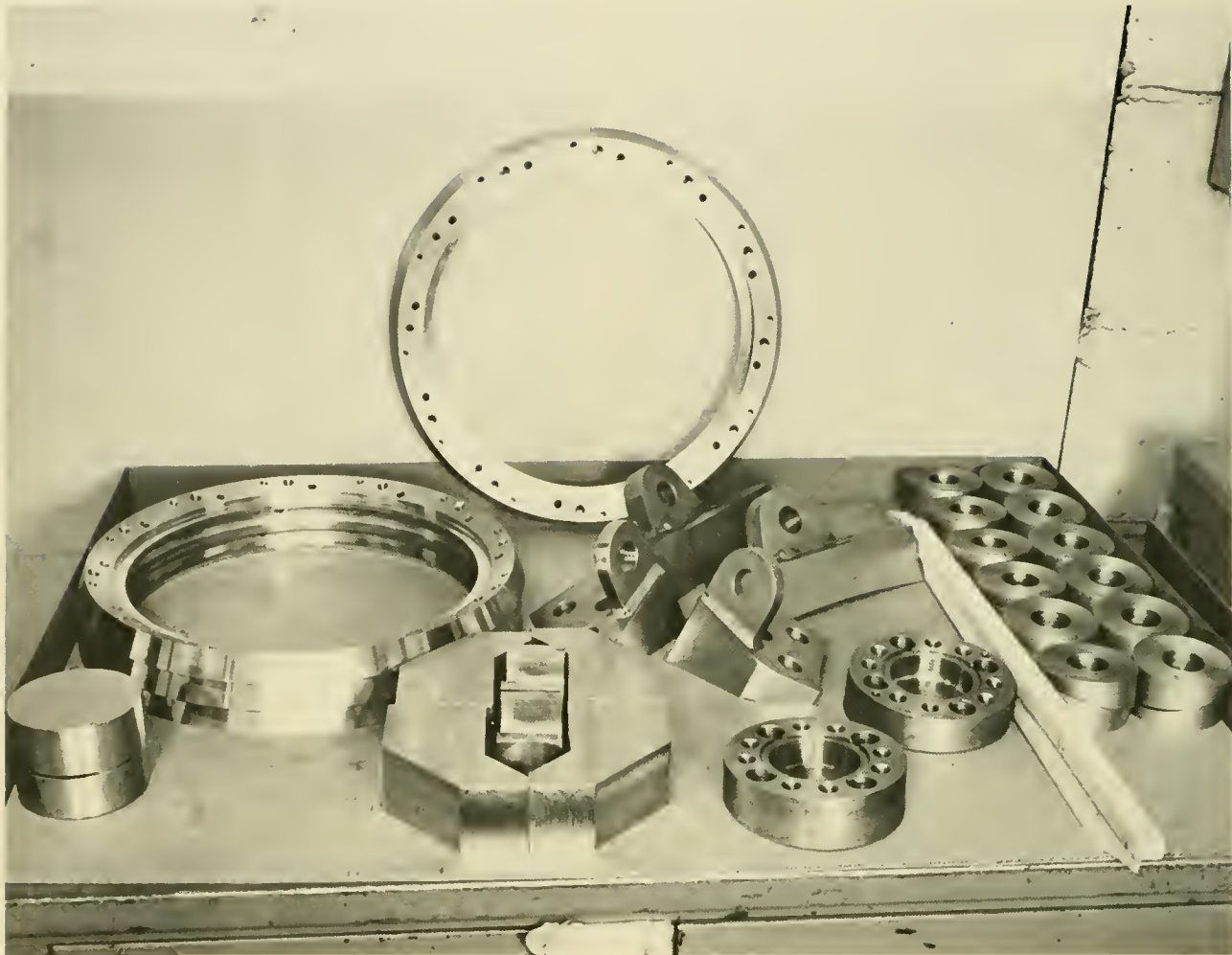

Fig. 5.11 Reinforcements and retainers for the pressure hull of ALVIN showing window retainers (background), lift padeyes (center), penetrator shims (right and foreground) and release hooks (center foreground). (WHOI)

with a taper of 4:1; viewport reinforcements in deep submersibles are slightly less than 100 percent.

### Hatches:

The majority of hatch or personnel access openings are circular and designed to fit as a cone in the pressure hull; the smallest of these is in the *DEEP STAR*-series vehicles where 15.75-inch diameter prevails. Two exceptions to the above generalization exist: 1) certain shallow-diving vehicles, *e.g.*, *PC-3A 1 & 2*, *NEKTON A,B,C*, where the hatch is a circular dome disk and fits flush over a cylindrical conning tower (Fig. 5.12) and 2) certain

lock-out vehicles where the hatch may be oval shaped. The reason for an oval shape in the lock-out vehicles, though not immediately apparent, is really quite simple and compelling. Within the lock-out portion of a submersible the internal pressure may not only equal, but may exceed, ambient (external) pressure during decompression on the surface. For this reason a double-acting hatch is required. This takes the form of an internal hatch and an external hatch. In order to initially install or remove the internal hatch from the pressure hull the access opening must be other than circular, otherwise it would be impossible to insert the larger diameter circular hatch through a smaller diameter penetration.



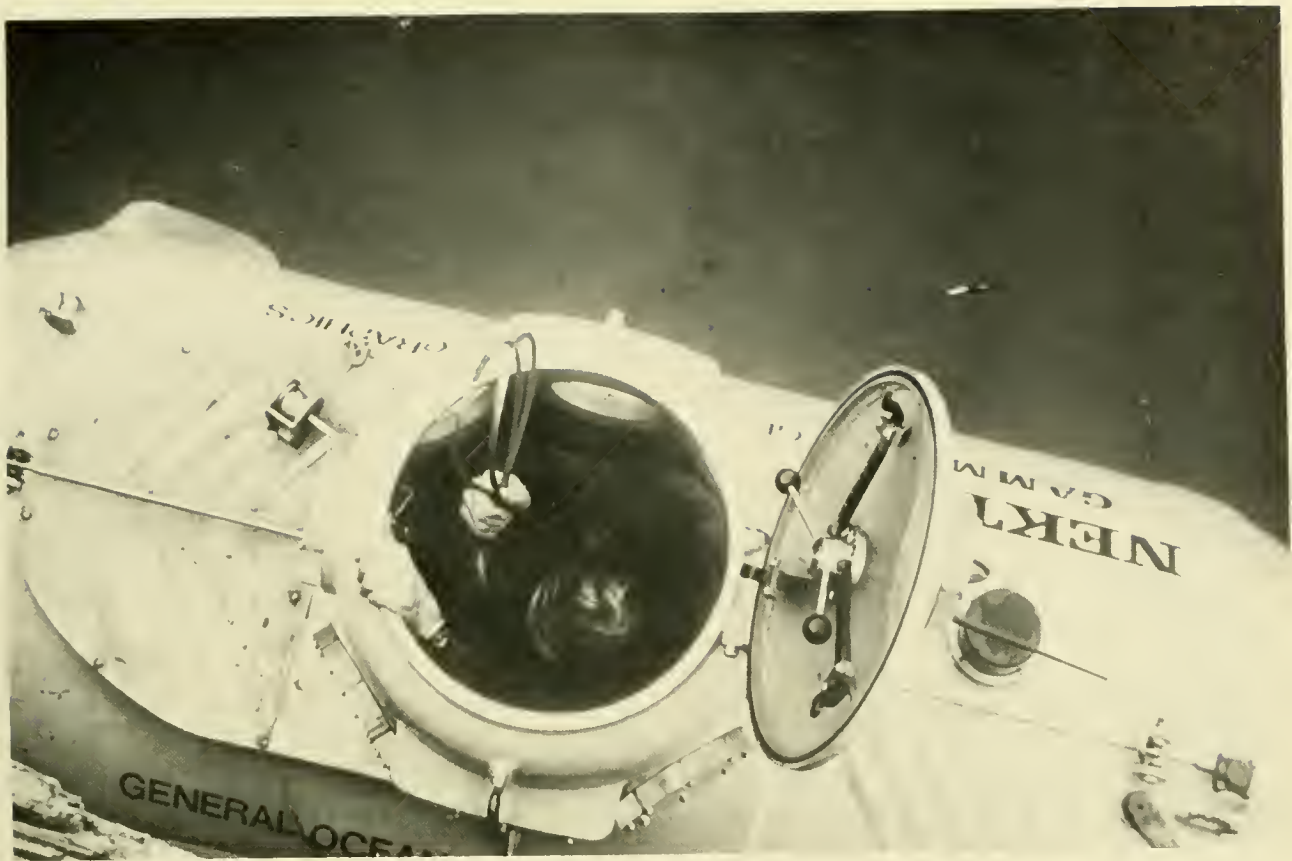

Fig 5.12 Hatch and cover of NEKTON GAMMA

**Electrical:**

There is a wide variety of electrical hull penetrations (Chap. 7) which serve an equally wide variety of functions. Basically the penetrator is sealed by an O-ring to prevent low pressure leakage and a hard metallic backup ring for a metal-to-metal seal at high pressure. Figure 5.13 presents the design of a penetrator for *DEEP QUEST*. By tightening the retaining nut the joint can be made to seal properly.

**Mechanical:**

Because of the tremendous pressures exerted on the hull of a deep-diving submersible, thru-hull rotating or reciprocating mechanical shafts and linkages are generally avoided. If the propulsion motor, for example, was located within the hull and rotated a propeller-driven shaft which penetrated the hull, a dynamic seal capable of limiting the leakage of seawater into the hull at differen-

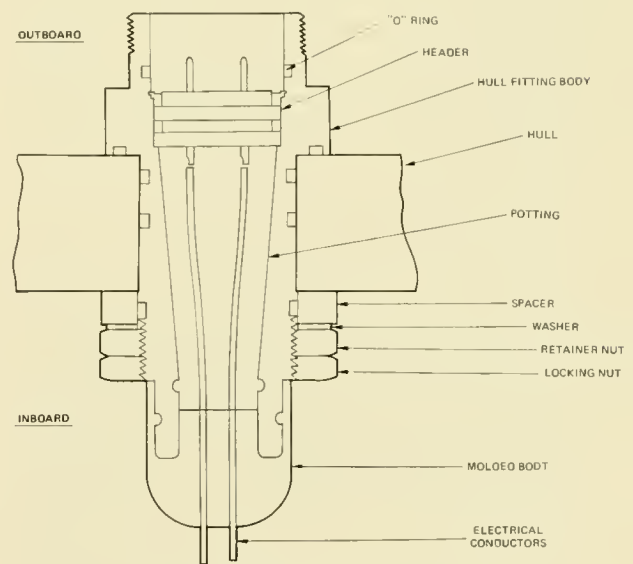

Fig 5.13 DEEP QUEST's electrical penetrator.

tial pressures of perhaps 7 or 8 thousand psi would be required; dynamic seals for these pressures are not available. To further complicate the problem, the pressure hull itself is not structurally stable and can be expected to shrink as the vehicle goes deeper. *ALUMINAUT* is calculated to lose 1 inch in length and 0.1 inch in diameter at 15,000 feet (17). Such characteristics further complicate the difficulties of mechanical penetrations on deep submersibles (greater than 1,000-ft depth), and is a prime reason for their general absence.

Nonetheless, mechanical penetrations are included on the shallow vehicles and in some cases on deep vehicles where their advantages are seen to outweigh their disadvantages. The following presents the functions of mechanical penetrators found on vehicles today.

a) **Propellers and Thrusters:** In vehicles such as *SEA OTTER*, *DEEP DIVER* and the *NEKTON* series, the main propulsion motor is housed in a watertight box penetrated by a shaft to drive the main propulsion unit or a thruster. The motor container is separate from the hull as a safety precaution, and the shaft, in *DEEP DIVER's* case, is sealed by a shoulder bearing against two sleeves screwed into the penetration and an O-ring for low pressure protection.

b) **Dive Planes and Rudders:** Some shallow-diving vehicles include hull penetrations for manual control of diving planes and rudders.

c) **Hatch Shafts:** Several vehicles include a mechanical penetration through the hatch which serves as a leverage or rotating point around which the hatch seals are closed or opened (Fig. 5.12).

d) **Weight Drop Shafts:** The greatest number of mechanical penetrations are for the purpose of dropping weights, generally in an emergency, to gain positive buoyancy. This type of penetration only rotates in one plane and is preferred over electric weight dropping actuators owing to the possibility of electrical failure. *ALVIN* incorporates such an arrangement to separate the sphere from the entire exostructure.

e) **Manipulators:** The *NEKTON*-class submersibles provide a mechanical penetration for a 3-ft-long steel rod which is manually

pushed out or pulled into the vehicle. The rod incorporates a claw at its outer end and can grasp samples as desired. According to Dr. R. F. Dill (NOAA, personal communication), at 1,000 feet the pressure shrinkage of the hull causes the arm to come down with "arthritis," and considerable effort is required to manipulate the device.

f) **Hull Vents:** Several submersibles contain penetrations for replenishing the pressure hull air or to equalize hull air pressure. In the first case snorkels are employed for surface cruising. In the latter case (*BEAVER*) a valve is activated in an emergency which brings main ballast air into the hull and builds pressure up to ambient so that the passengers may open the hatch and exit. The All Ocean Industries' submersible has a curious arrangement whereby the main ballast tanks vent into the pressure hull. To prevent a buildup of air pressure a second valve, connected to a snorkel, is opened and the air vents outboard. The operating instructions for the submersible cautions the operator to secure the ballast tank vent valve as soon as a little water appears inboard.

#### **Viewports:**

In an extremely detailed and comprehensive paper, NCEL engineers Snoey and Stachiw (22) present the history, application, advantages and disadvantages of materials and shapes for submersible viewports. The basis for their report rests in a series of exhaustive tests and analyses of viewports and their materials at NCEL. The reader is referred to this report and its references for detailed aspects of viewport design and materials capabilities.

Three materials have been used for viewports: fused quartz, acrylic plastic and glass. The first of these was used by Beebe in the *BATHYSHERE*, but his difficulties with cracking and chipping persuaded the elder Piccard to look for an alternative, which proved to be acrylic plastic. Acrylic plastic is now the accepted viewport material for all but two submersibles; *KUROSHIO II* and *YOMIURI* both use glass.

Table 5.5 presents the properties of glass and acrylic plastic. In essence, where one is strong, the other is weak. According to refer-

TABLE 5.5 PROPERTIES OF MATERIALS [FROM REF. (22)]

Property	Acrylic Plastic Rohm & Haas PLEXIGLAS G	Glass Corning PYREX Code 7740	Units
Tensile Strength (Maximum)	10,500	10,000	psi
Modulus of Elasticity (Tensile)	450,000	9,100,000	psi
Compressive Strength (Maximum)	18,000	300,000	psi
Modulus of Elasticity (Compressive)	450,000	9,100,000	psi
Flexural Strength (Maximum)	16,000	35,000	psi
Shear Modulus	166,000	3,900,000	psi
Impact (Charpy)	14.0	Very low and Scattered	ft-lb/in. <sup>2</sup>
Poisson's Ratio	0.35	0.2	—
Hardness	Rockwell M-93	Knoop 481	—
Deformation Under Load	0.5 (4,000 psi @ 122°F, 24 hr)	0	%
Specific Gravity	1.19	2.23	—
Specific Heat	0.35	0.233	Btu/lb°F
Coefficient of Thermal Conductivity	0.11	0.92	Btu/hr ft°F
Coefficient of Thermal Expansion	40 x 10 <sup>-6</sup>	1.78 x 10 <sup>-6</sup>	in./in./°F
Water Absorption	0.2	0	%
Corrosion Resistance	Excellent	Excellent	—
Refractive Index	1.49	1.47	—
Light Transmission	92	90	%

ence (22) there are three major disadvantages with glass as viewport material:

- 1) Poor reproducibility in mechanical properties from one manufactured specimen to another stemming from inadequate quality control.
- 2) Occurrence of tensile stresses in designs for a material that has low tensile strength and no tolerance for localized

yielding. The tensile stresses usually stem from glass/metal interfaces.

- 3) Glasses fail catastrophically without any prior yielding or permanent deformation that might serve as warning.

On the other hand, plastic offers the following advantages:

- 1) Reproducibility in physical properties from one viewport to another is excellent.

- 2) The low modulus of elasticity and plastic flow characteristic permit localized yielding and redistribution of stresses.
- 3) The plastic flow in the form of extrusion and extensive fracturing provides warning of impending failure sufficiently in advance to terminate a dive without the viewport imploding.
- 4) Another report (23) states that before failing plastic becomes translucent, but this was not reported in the NCEL studies.

For such reasons acrylic plastic is the prime viewport material in submersibles. That plastics will remain in this exclusive position is difficult to predict. According to Edgerton (24), glass has the advantage of less optical distortion than plastic, and from Figure 5.3, it is clear that glass offers the best W/D ratio. The present difficulty in working with glass primarily reflects its newness as a candidate for pressure hulls. Acrylic plastic also offered initial difficulties, but years of research and testing have brought it to the point where it will advance from a Category III to a Category II material (see Chap. 13) after long-term loading tests, now in progress, are completed to determine its creep and fatigue characteristics. If the need for glass as a pressure hull, viewport or other component material be-

comes pressing, it is likely that the technology will evolve to overcome its present deficiencies.

Three configurations are used to join acrylic plastic viewports to the pressure hull: Flat circular discs, truncated cones and wrap-around windows such as in Martine's *SUB-MANAUT*. Considerable testing and evaluation of the first two forms (Fig. 5.14 & 5.15) have been conducted on acrylic viewports at the U.S. Naval Civil Engineering Laboratory (25, 26). No studies are reported for the characteristics of the wrap-around variety.

**Flat Viewports:** The results of the NCEL studies show that the windows should be sealed in a flange cavity by means of a radially compressed "O" ring contained in a circumferential groove midway between the viewport's parallel faces. The viewport may bear directly on the steel seat or on a  $1/32$ -inch-thick neoprene gasket. If no gasket is used, a liberal coating of silicone grease applied to the flange may suffice. To hold the viewport a retaining ring resting on a  $1/4$ -inch rubber gasket of 60- to 100-durometer hardness is recommended. The viewport should have a maximum diameter to minor opening ratio of 1.5 and a radial clearance of 0.005 inch or less between viewport edge and flange cavity (Fig. 5.14). Reference (25) recommends that a safety factor of 4 be used at

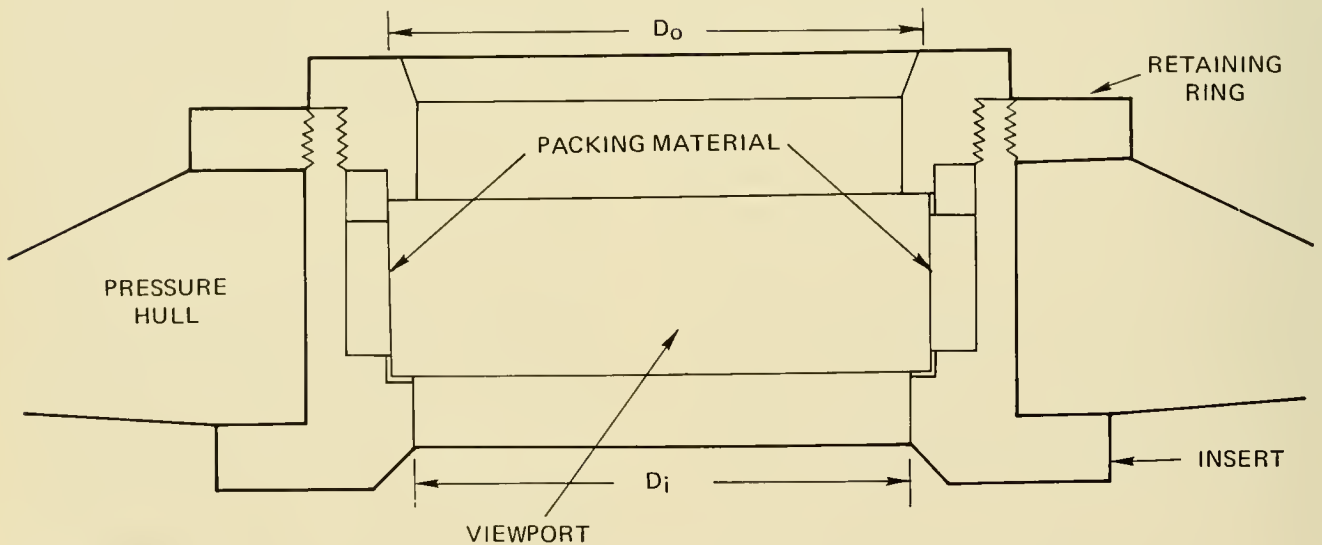

Fig. 5.14 Flat acrylic plastic viewport.

these conditions. It is impractical to construct the viewport flange or its housing out of the hull itself. For this reason, an insert is separately machined, then forged to the desired tapered thickness and subsequently welded into the hull with the insert in place. The inserts are also required to be of material similar to that of the hull.

**Conical Viewports:** From its first inception, the 90 degree conical acrylic plastic viewport

of Professor Piccard has been the mainstay of deep submersibles. The only reported incident of failure was aboard *ASHERAH* when it struck an underwater object and cracked its viewport; however, no flooding resulted. Exhaustive testing (26) of plastic viewports of various thicknesses and angles produced sufficient knowledge to recommend dimensional constraints and viewport seal design. Figure 5.15 presents typical sealing on past

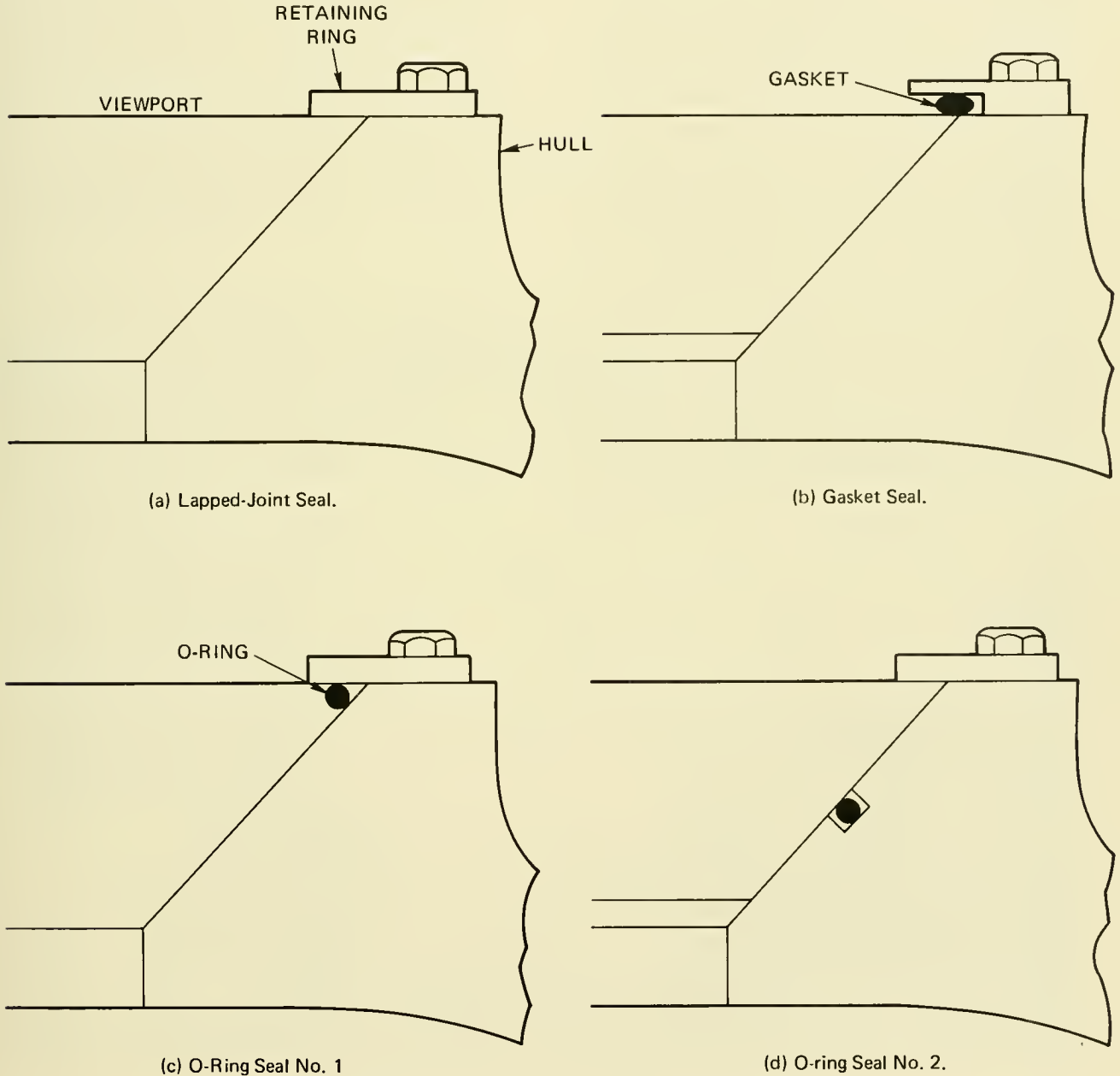

Fig. 5.15 Current conical viewport seal designs. [From Ref. (26)]

and present submersibles; Figure 5.16 presents a design recommended for habitats as well as for submersibles where long-term creep loading introduces more stringent requirements.

All the current and proposed designs call for a retaining ring and either an "O" ring or gasket for low pressure seals. The high pressure seal is effected by making a lapped-joint seal between the viewport and insert. An 80- to 90-percent contact is achieved by surface finishing in the 8- to 32-rms range. Snoey and Katona (26) provide a step-by-step derivation of the formulas and curves related to conical viewport design and include test procedures which preceded these data.

#### Piping:

Submersible piping systems serve several functions:

**Ballasting:** Carrying compressed air from storage to ballast tanks for blowing.

**Trim:** Transporting trim fluids fore or aft to their respective reservoirs.

**Hydraulics:** Transporting fluid to activate a device such as a manipulator or weight dropper.

**Breathing Gasses:** Supplying air or mixed gas from external reservoirs into the pressure hull or within the pressure hull itself.

Four types of materials have been used to perform these functions: Cupro-nickel, monel, stainless steel and flexible wire-braided plastic hose.

Cupro-nickel (7030) is a universally accepted piping material for the transfer of salt water. It is very corrosion resistant but costly.

Monel has the same advantages as cupro-nickel and has been used primarily for oxygen systems. Its disadvantages are not only cost, it is difficult to obtain by virtue of its wide use and demand in military submarines. Strangely, according to Purcell and Kriedt (27), it is not clear why monel is the preferred material for oxygen systems in U.S. military submarines; indeed, after a thorough investigation into the advantages and disadvantages of other materials, they conclude that other materials would serve as well.

Stainless steel piping finds wide application in submersibles of the private sector. Though not as corrosion resistant as cupro-nickel and monel, it is far less expensive and easily obtained. Standard aircraft  $3/8$ -inch stainless steel is the most commonly used variety.

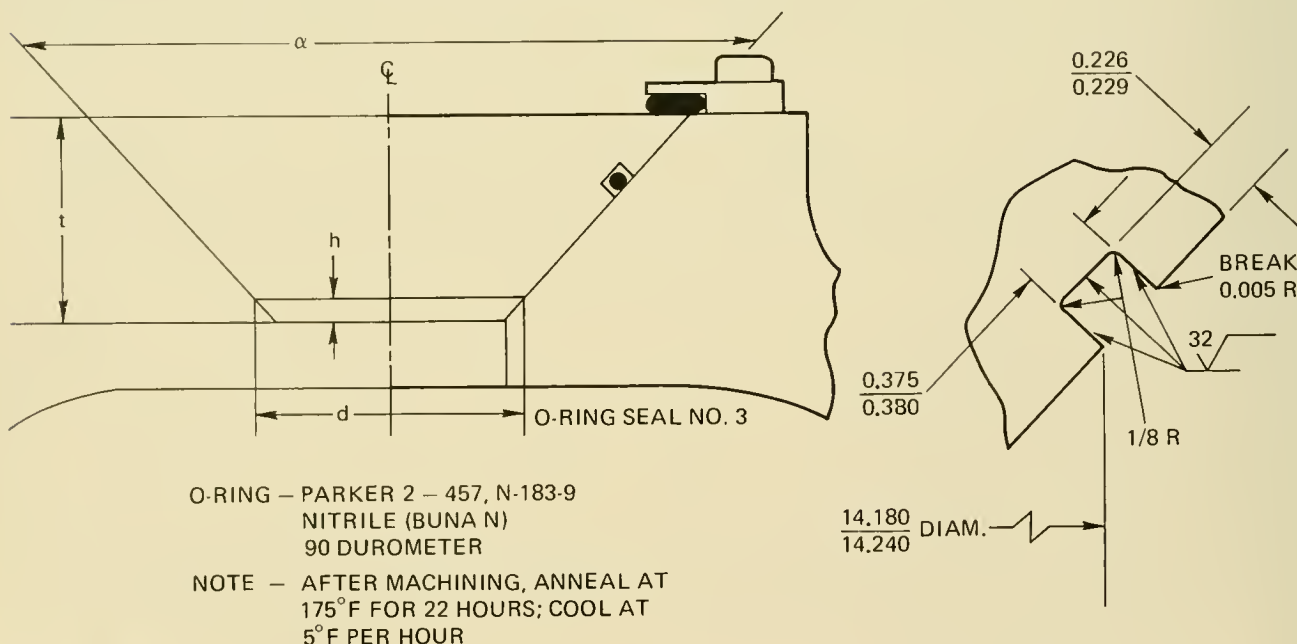

Fig. 5.16 Recommended viewport seal design. [From Ref. (26)]

Under conditions where the piping will serve vibrating or rotating devices, such as manipulators, flexible hosing is sometimes used to transport the hydraulic fluid. Several varieties of wire-braided plastic hosing are available to serve this function.

## EXTERNAL STRUCTURES

External to the pressure hull are two major structural components: 1) An exostructure consisting of a supporting framework to carry the pressure hull and operational devices; and 2) a fairing enclosing the exostructure and, in some cases, streamlining the hull to reduce both hydrodynamic drag and the potential for fouling with underwater objects.

## EXOSTRUCTURE

Penzias and Goodman (28) aptly describe a

submersible's exostructure as ". . . the framework on which everything else hangs; the pressure hull being merely one of the 'cargo units' suspended within or beneath it." The exostructure of **DEEPSTAR 4000** in Figure 5.17 demonstrates their analogy.

In several of the large, cylindrical vehicles, e.g., **ALUMINAUT**, **BEN FRANKLIN**, **AUGUSTE PICCARD**, much of the equipment that would be external to a smaller spherical pressure-hulled vehicle is carried inside because of the availability of greater interior volume. Consequently the need for an exostructure is limited to propulsion mountings, rudders, diving planes and control sensors such as sonar and echo sounders. The majority of spherically hulled submersibles, however, require an exostructure.

Having decided on the shape, penetrations and materials for the pressure hull, design of the exostructure should be completed prior

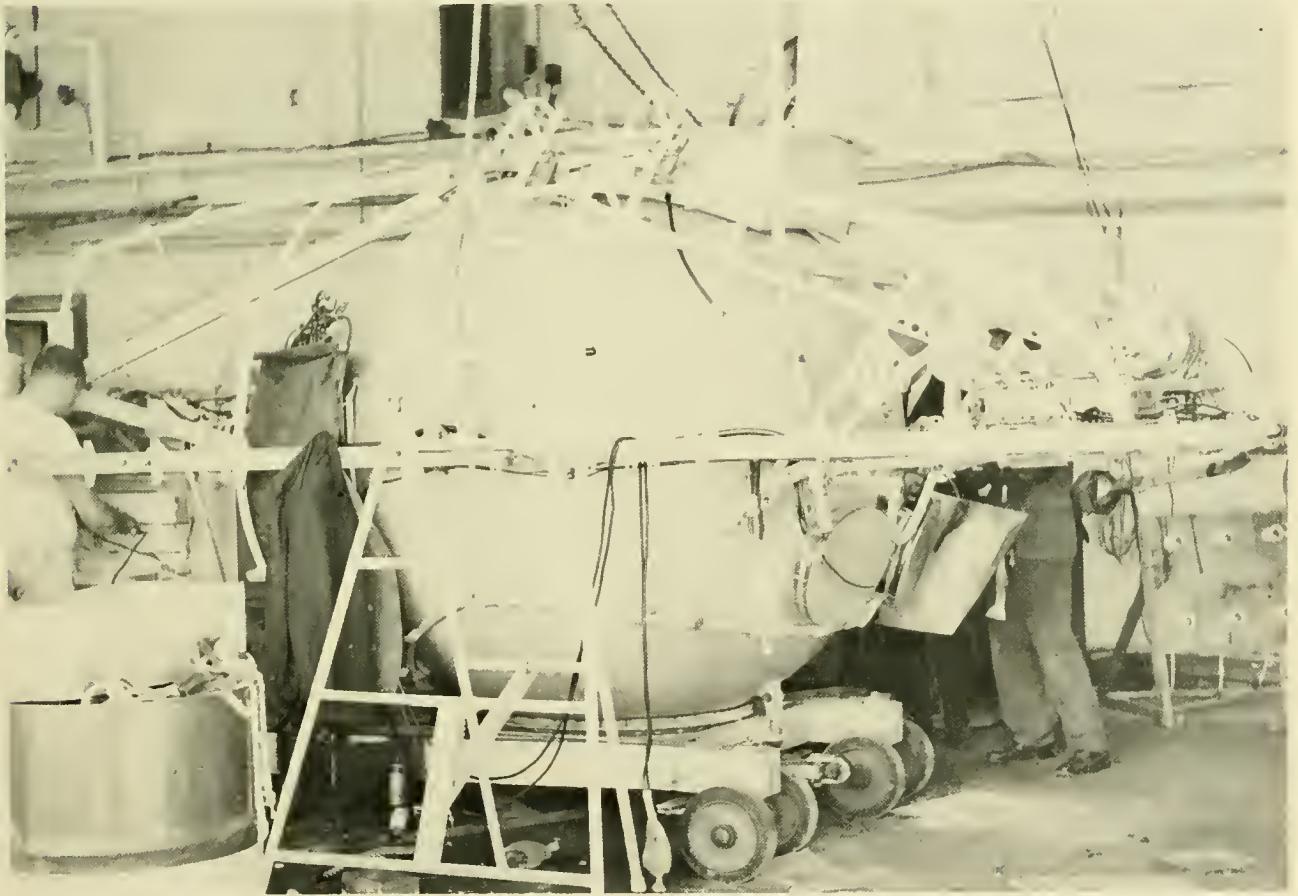

Fig 5.17 The exostructure of **DEEPSTAR 4000**. (Westinghouse Corp.)

to final stress relief of the hull. As explained above, if the exostructure is to be bolted to the hull, which many are (Fig. 5.17), the attachment points should be welded on before final stress relieving in order that no residual stresses remain in the welds or heat-affected zones. If the exostructure is to be strapped to the hull, e.g., *SDL-1*, then such precautions are unnecessary.

Design of the exostructure is preceded by a great deal of research into the vehicle's projected components and subsystems; essentially, the submersible is virtually "sized" (see Chap. 6) by the time the exostructure is

designed. Figure 5.18 provides an idea of the complexity involved in packaging the variety of necessary equipment. Some of the considerations that must be resolved before final design are as follows:

- 1) Location of objects as they affect trim, buoyancy and their own ability to perform.
- 2) Volume of objects: Are they compatible with the dimensional constraints of the vehicle?
- 3) Weight of objects both in air and in water.

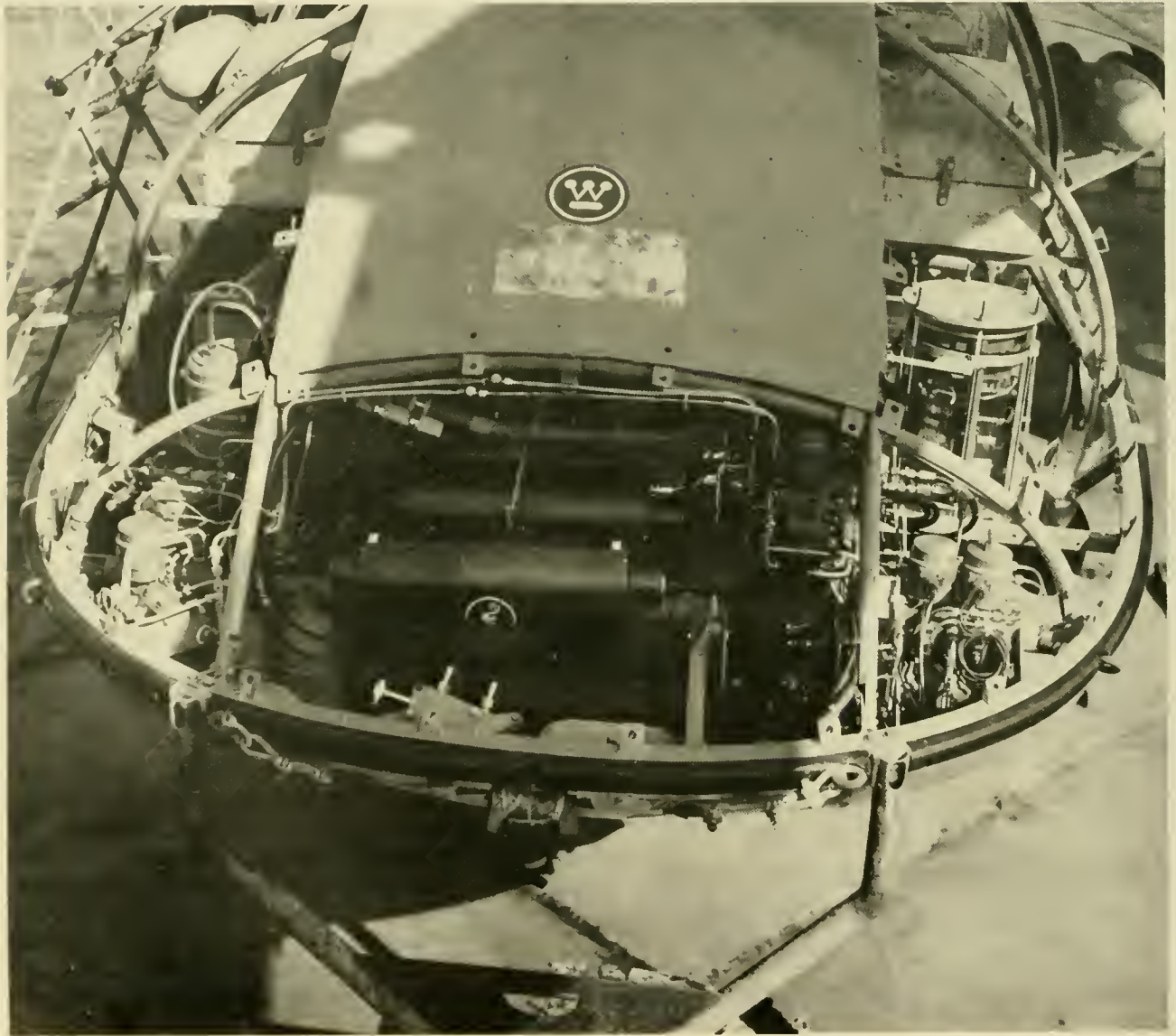

Fig 5.18 Stern view of DEEPSTAR 4000 showing "packing" of the exostructure. (NAVOCEANO)



- 4) Displacement of objects as they affect buoyancy.
- 5) Non-interference with hookup points if the vehicle is to be launched/retrieved.
- 6) Strength of the exostructure. Clearly, the fully encumbered exostructure must be able to withstand the anticipated rigors of shock loading both at sea and during transport.
- 7) Accessibility of components which may require routine removal and servicing without completely disassembling the framework.
- 8) Shape of the exostructure—that it provides a framework compatible with the final desired vehicle configuration.
- 9) Method of attachment to the pressure hull must be such that no concentrated or restraining loads exist.

When such questions are resolved, the selection of a material remains. In this case it is critical to ascertain the likelihood of corrosion because of contact of dissimilar metals at the point of exostructure-to-pressure hull attachment, and where bolts or nuts of dissimilar metals may be used to join the exostructure together. Finally, the material selected must be lightweight in order to maintain a favorable W/D ratio and must lend itself to easy fabrication and assembly. Aluminum is a prime candidate because of its low density. However, some aluminum alloys are susceptible to crevice corrosion. The danger of galvanic corrosion requires that aluminum must be insulated from steel components. Both steel and aluminum are used in present submersibles because of their availability, ease of fabrication, maintenance, long useful life and cost.

While all submersible pressure hulls, as far as is known, are securely and quasi-permanently affixed to their exostructures, there are exceptions. In the case of *ALVIN*, *SEA CLIFF* and *TURTLE*, the pressure hulls are attached to their exostructures by one steel shaft which penetrates the bottom of the pressure hull and affixes to the framework. In the event of an emergency, such as fouling or loss of positive buoyancy systems, the thru-hull shaft may be manually rotated from within the hull to activate a cam and release the pressure sphere and sail from the main body. Being positively buoyant, the

sphere is capable of ascending to the surface. Electrical connections are the quick disconnect variety which break away as the sphere ascends.

## FAIRINGS

The fairings of submersibles serve three purposes: 1) Reduce hydrodynamic drag; 2) minimize the potential for fouling with submerged ropes, cables or other objects and 3) allow the vehicle's hatch to be opened on the surface without swamping. On the other hand, three opposing arguments may be advanced against fairings: 1) Submersibles operate at such low speeds that reduction of hydrodynamic drag is unnecessary; 2) if the submersible offers sufficient visibility, such as an acrylic plastic hull, the operator can see all potential hazards and avoid them; and 3) opening the hatch before the vehicle is safely aboard its support ship is inherently dangerous and should be avoided. The countering arguments are quite valid and would suffice but for one obstacle: There is nothing predictable about diving or the ocean. Chapter 14 deals with the fatal and near-fatal hazards experienced to date, and it would suffice here to present two incidents to show the danger of not having fairings: 1) On 17 June 1973, the acrylic plastic-hulled *JOHNSON SEA LINK* became entangled in the debris of a scuttled destroyer at 360 feet off Key West, Florida. The unfaired *SEA LINK* was held 31 hours until pulled free of its restraint. Two men in the aft aluminum pressure cylinder perished as a result. 2) Diving in the Gulf Stream, the submersible *DEEPSTAR 4000* became separated from its support ship *SEARCH TIDE* while submerged. Upon surfacing, neither the ship's radar nor radio direction finder could locate the submersible. As a final resort, a trunk surrounding the hatch was inflated and the hatch opened, thereupon allowing the operator to fire off flares which were seen by the surface ship and allowed recovery. No personnel perished.

It is debatable that reduction of hydrodynamic drag is necessary. If the vehicle is towed, however, some protection against drag and wave slap must be provided for its cables and external instruments. There is no question of the need to reduce fouling poten-

tial (Fig. 5.19), or to be able to open the hatch on the surface.

The most used fairing material is fiberglass molded and cut to the desired shape, and bolted or screwed to the exostructure. An aluminum alloy, Alcad 5083, constitutes *ALUMINAUT*'s fairing, while plain sheet metal serves the purpose on small, privately owned submersibles of the *SEA OTTER* variety. Though fiberglass offers a wider variety of advantages than metal, *e.g.*, non-corrosive, greater formability, the process of designing and fabricating a mold is costly, and, for one-of-a-kind vehicles, may be excessively expensive where sheet metal serves almost as well. In vehicles where an echo sounder transducer is located within the fairing, it is necessary to cut out the fiberglass portion the transducer will insonify and install a rubber-based section to serve as an "acoustic window."

The overall design of the fairing is an individual matter. Obviously it must be so configured as to permit the submersible to be

handled, especially during launch and retrieval. It should also permit easy removal for access to external components. For example, *DEEPSTAR 4000*'s fairing (Fig. 5.20a) is attached in sections sufficiently small to allow hand-removal and access to any component. On the other hand, the fairing on the Navy's *DSRV* (Fig. 5.20b) may be removed, but requires a lifting device which may be quite difficult to manage in high seas.

## PRESSURE TESTING

When the pressure hull is completed, and thru-hull penetrators are in place or blanked, it is customary to subject the structure to pressure tests. For submersibles of the *BEN FRANKLIN* variety, there are no options on the choice of test tanks; only the ocean is sufficiently large. Hence, pressure testing of the hull must be deferred until the vehicle is in actual service. For smaller vehicles, *e.g.*, up to *ALVIN*-size, there are several test facilities throughout the country where



Fig. 5.19 *STAR III* approaching an underwater structure off Nassau, Bahamas (Gen. Dyn. Corp.)

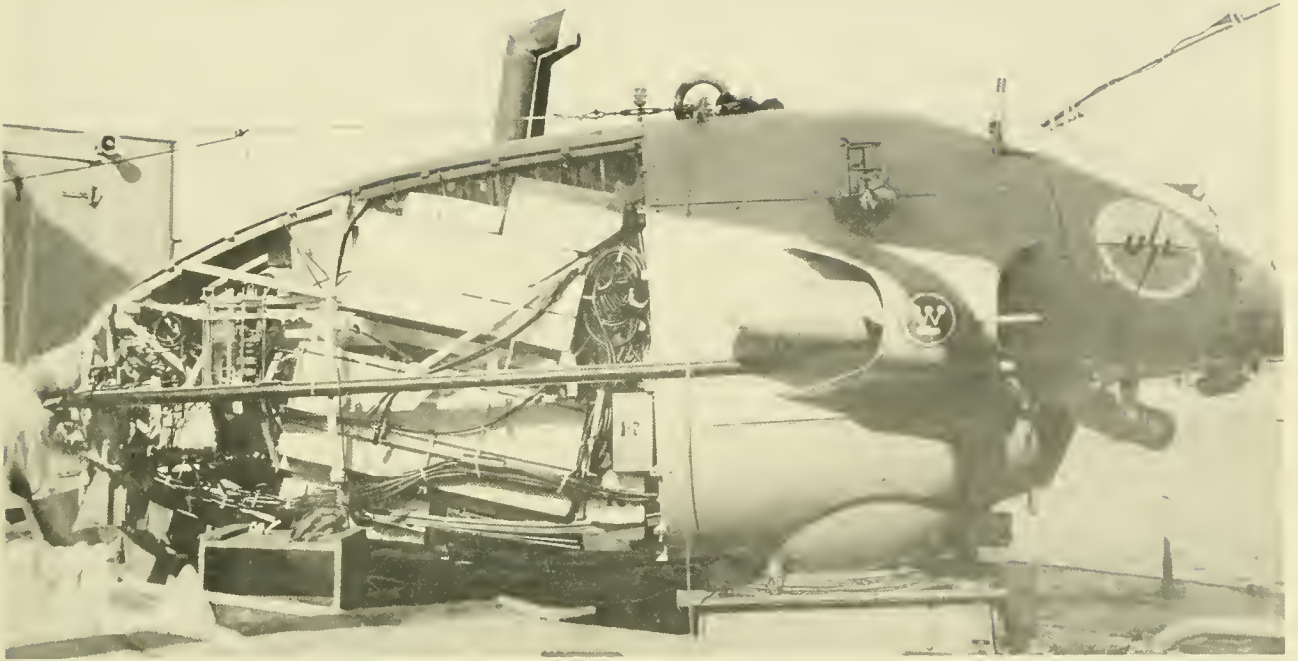
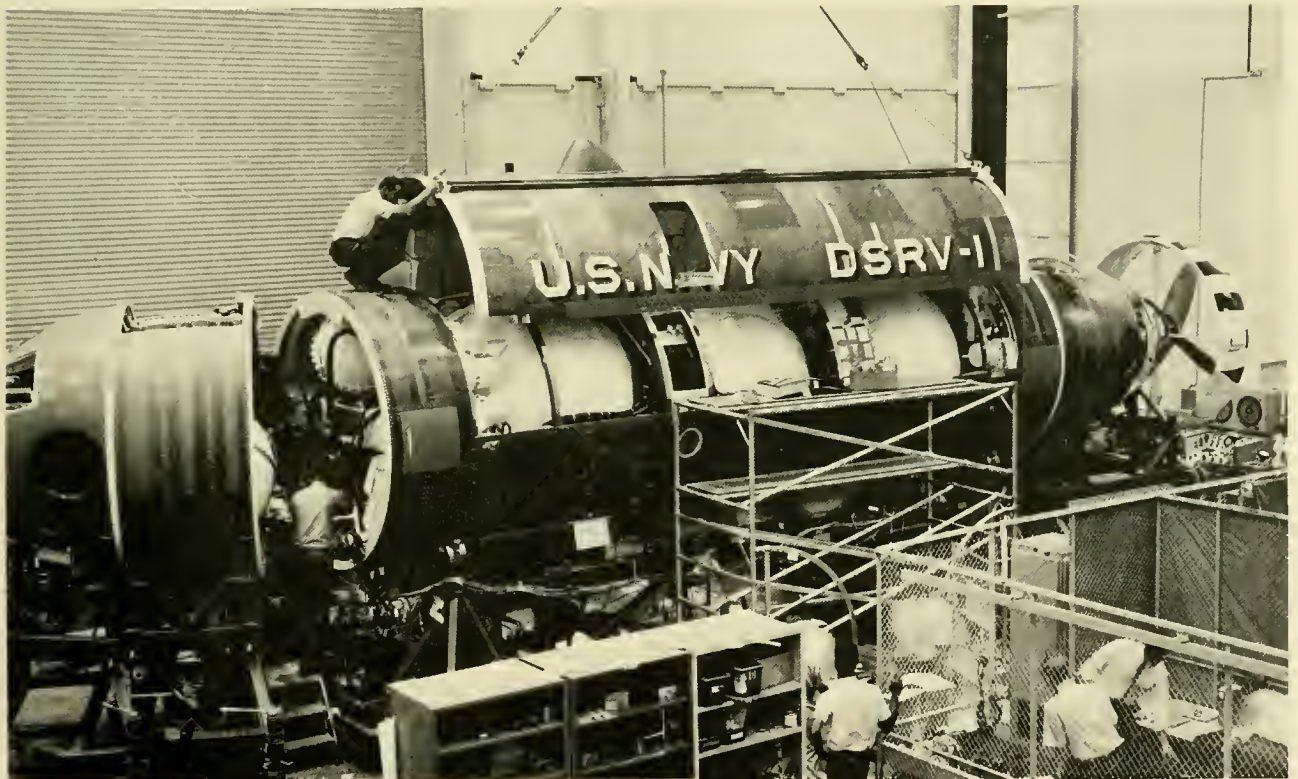

Fig 5.20 DEEPSTAR 4000 (above) and DSRV-1 (below) with fairings removed (NAVOCEANO, LMSC)



**TABLE 5.6 U.S. PRESSURE TANK FACILITIES GREATER  
THAN FIVE FEET DIAMETER [FROM REF. (28)]**

	Internal Diam. (ft)	Length (ft)	Static Pressure (psi)	Cyclic Pressure (psi)	Pressure Medium	Temp. Control
Boston Naval Shipyard	5.0	5.0	1,500	None	FW/SW <sup>1</sup>	None
Boston, Mass	8.0	5.0	500	None	FW/SW	None
Elec. Boat Div., Gen. Dynamics Groton, Conn.	7.5	14.75	1,000	None	FW	None
Mare Island Naval Shipyard	6.0	12.0	1,000	None	FW/SW	None
Vallejo, Calif.	9.0	10.0	550	None	FW/SW	None
Naval Civil Engineering Lab. Port Hueneme, Calif.	2.0	15.0	3,500	0-2,750	FW/SW	None
Naval Mine Engineering Facility Yorktown, Pa.	7.0	13.0	600	None	FW	None
Naval Ordnance Lab. White Oak, Md.	8.33	36.5	1,250	0-1,250 0.2 CPH	FW	None
Naval Research Lab. Orlando, Fla.	8.3	26.0	1,000	0-1,000 10 CPH	FW	12-40°F
Naval Ship Research & Devl. Ctr. <sup>2</sup> Carderock, Md.	5.0	9.0	20,000	0-10,000 1 CPM	FW/Oil	None
	10 (sphere)		10,000	0-10,000 0.5 CPM	Oil/FW/SW	37-70°F
	6.0	21.0	6,000	0-5,600 1 CPM	Oil/FW/SW	None
	11.5	30.0	1,000	0-1,000 1 CPM	Oil/FW/SW	None
Naval Ship Research & Devl. Ctr. Annapolis, Md.	10.0	27.0	12,000	0-4,000	SW/FW	30-100°F
Naval Undersea Res. & Devl. Ctr. San Diego, Calif.	5.0	10.0	10,000	None	FW/SW	28-75°F
Newport News Shipbuilding & Drydock Co. Newport News, Va.	5.0	23.0	1,000	None	FW/SW	None
Ordnance Research Lab. University Park, Pa.	5.0	13.75	16,000	0-16,000 1/8 CPH	FW	None
Perry Submarine Builders Riviera Beach, Fla.	8.0	29.0	1,300	None	FW	None
Portsmouth Naval Shipyard Portsmouth, N.H.	30.0	75.0	600	0-600 1 CPM	SW	None
	8.0	14.0	600	None	FW/SW	None
Puget Sound Naval Shipyard Bremerton, Wash.	6.0	12.0	1,500	None	FW	None
Southwest Research Institute San Antonio, Texas	7.5	19.17	4,000	0-2,000	FW/SW/Oil	None
	7.58 (sphere)		1,200	0-1,200	FW/SW	32-85°F

<sup>1</sup>FW = Fresh water; SW = Seawater

<sup>2</sup>All tanks to be replaced by one 13.0-ft-diam., 40-ft-long, 3,000-psi tank.

the entire vehicle can be accommodated (see Table 5.6).

Historically, pressure testing programs proceeded along lines which started from unmanned, tethered or untethered dives and grew progressively deeper to the vehicle's maximum operating depth and to some point beyond (test depth). Beebe's *BATHYSPHERE* was lowered on a cable; Auguste Piccard's *FNRS-2* was equipped with a depth gage that dropped ballast at a pre-set depth, and a timer that performed the same task if the depth gage failed to function. In the event that *FNRS-2* drifted into shallow water, an antenna-like object was affixed to

strike the bottom first and dump ballast before the vehicle struck the bottom. In both *BATHYSPHERE* and *FNRS-2*, the ability of the pressure hull to withstand the deep pressures was observed merely by the presence or absence of seawater inside the sphere.

When large vehicles of the *ALUMINAUT* variety appeared, pressure tests began with the finished vehicle making progressively deeper, manned dives and conducting strain gage readings on each dive. *ALVIN*, on the other hand, was sent down initially unmanned to 7,500 feet on a tether before manned dives to 6,000 feet were conducted.

Vehicles of the *PAULO I* variety (Fig. 5.21)

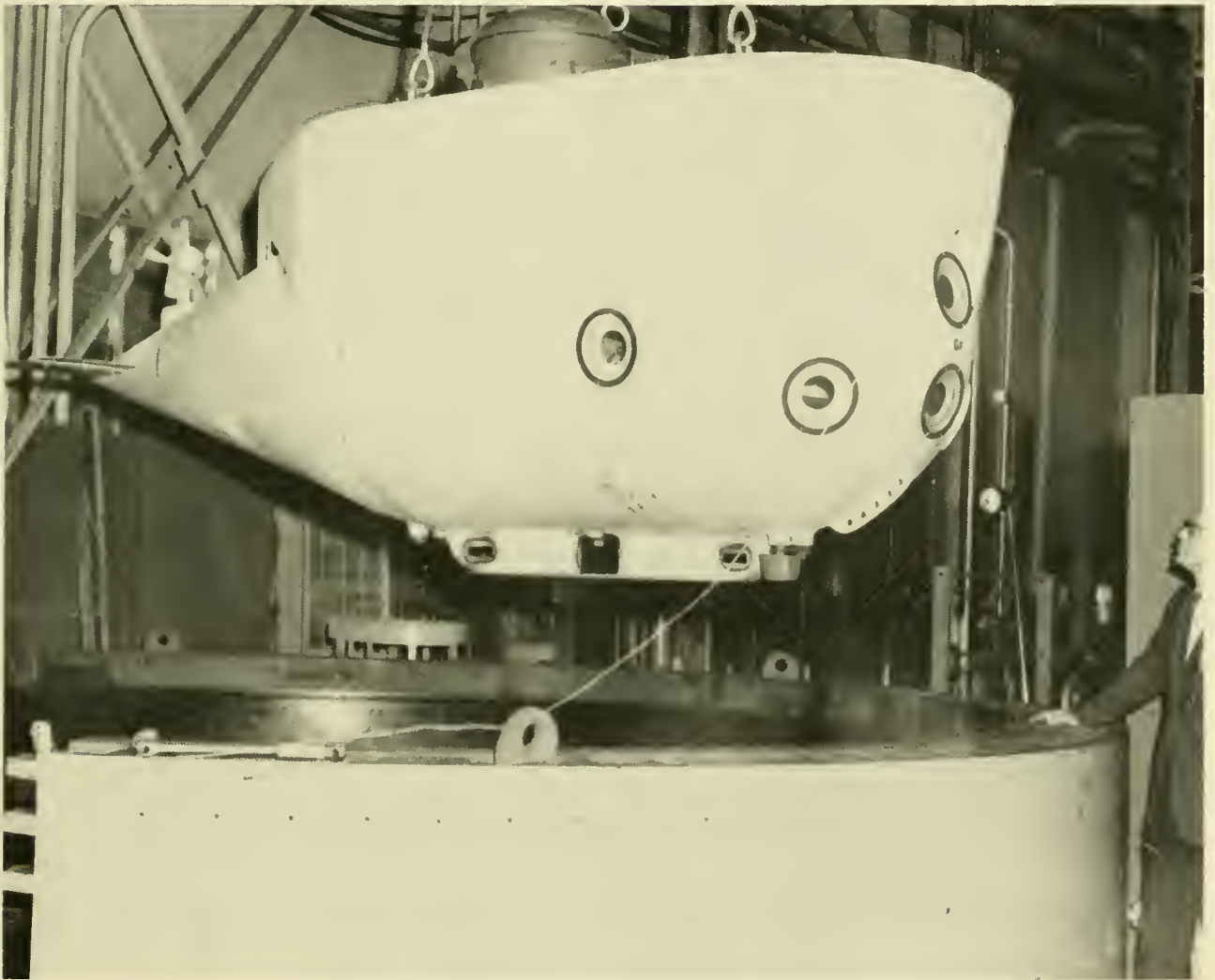

Fig. 5.21 *PAULO I* (now *SEA OTTER*) entering a test tank for pressure testing. (Anautics Inc.)

are amenable, by virtue of their small size, to options other than the deep sea. Test tanks offer the advantage of being far less expensive and troublesome than open-ocean testing; pressures can be better controlled, and the test can be monitored more precisely. A great advantage lies in the fact that the pressure hull alone may be tested prior to completion of the entire vehicle. Invariably, when the vehicle must be tested as an operating unit, failure of operational components, such as motors, depth gages, sonars, etc., or inclement weather, results in delayed test programs. In a test tank the vehicle may be tested component-by-component, then assembled and tested in its entirety. In the event of hull failure, an obvious advantage with such testing is that no personnel are required in the vehicle. Another advantage resides in the speed with which the pressure may be relieved or the tank emptied of

water. If, for example, an electrical penetrator failed and water began entering the hull, the test tank could be emptied in a few minutes.

While unmanned open-sea tests on a tether may be as conclusive as tank tests, they include the risk that the object being tested may be lost. As previously noted, both *SP-350* and *SP-3000* pressure hulls were lost when the tethers gave way.

## PRESSURE TEST FACILITIES

According to reference (29), at least 23 test tanks in the U.S. are sufficiently large to accommodate submersible pressure hulls of 5-ft diameter and greater (Table 5.6). With the advent of the Ocean Pressure Laboratory at the Annapolis, Maryland-based Naval Ship Research and Development Center, whole vehicles such as *DEEPSTAR 2000* (and larger) may be tested in their entirety.

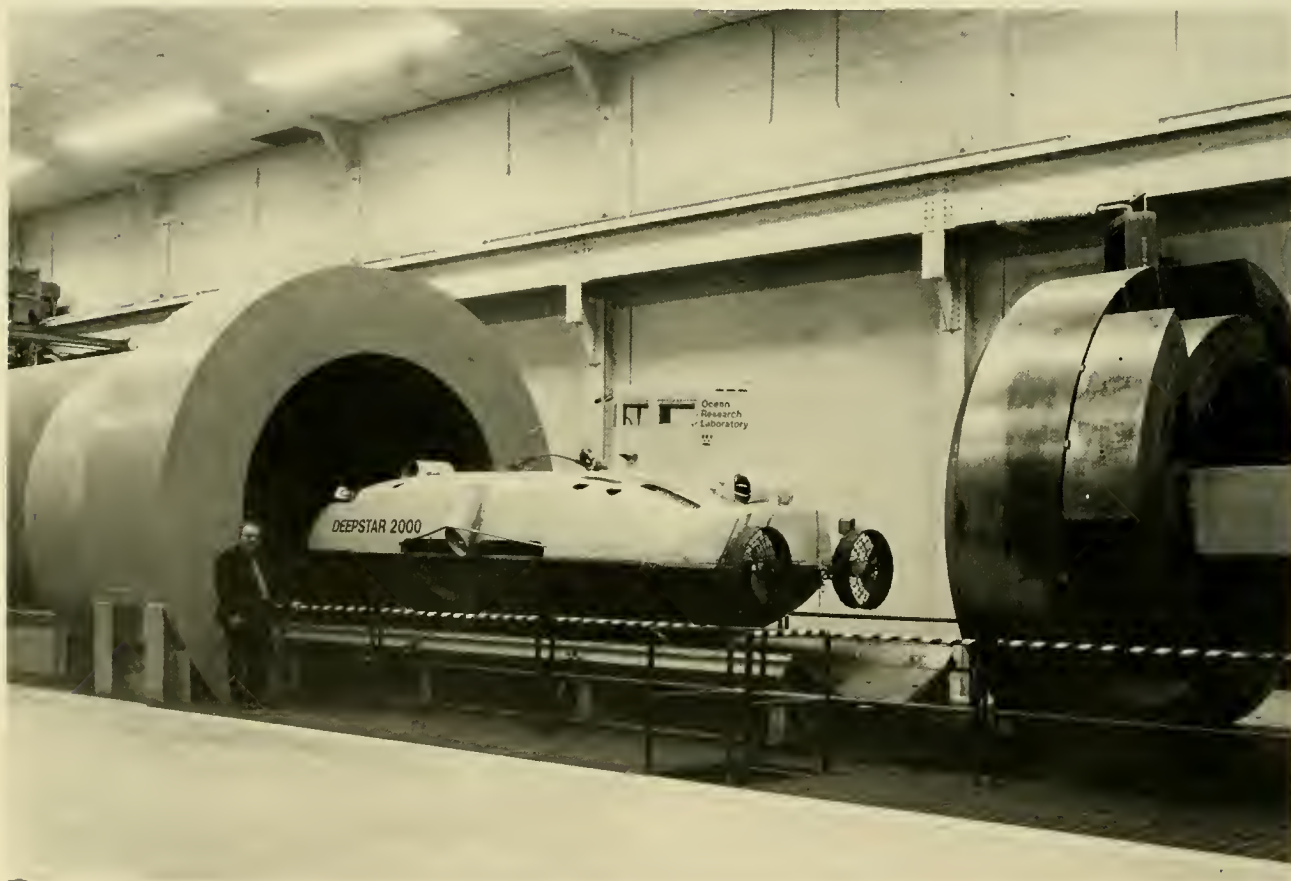

Fig. 5 22 (a) *DEEPSTAR 2000* prepares to enter the U S Naval Ship Research and Development Center's 12,000 psi pressure tank. (U.S. Navy)

Such installations provide thru-chamber connections from the test specimen to data monitoring equipment on the outside. Temperatures may be lowered to those values anticipated within the vehicle's diving range and scope of operations, and some, though not all, can use seawater as the pressurizing medium.

Other pressure testing facilities are available at private industry and academic institutions, but the only two reportedly used to date for submersible hulls are those of the Southwest Research Institute and Perry Submarine Builders (Fig. 5.22). Constructed primarily for government test programs, Navy test facilities may be used by private industry at a cost dependent on time and effort required, and on a not-to-interfere basis.

## PRESSURE HULL MEASUREMENTS AND TESTS

The variety and quantity of pressure hull tests are quite numerous. Accompanying such tests is the need for documentation and recording the results. Although it is not a legal requirement, most private American submersible owners strive to attain classification by the American Bureau of Shipping. Naval submersibles have quite stringent certification requirements of their own. Hence, the certifying or classifying authorities must have written documentation of the tests and their results. Prior to 1968, the submersible builder had few if any guidelines to follow regarding tests and documentation. In 1968 the Marine Technology Society published *Safety and Operational Guidelines for Undersea Vehicles* (3) which outlines in detail

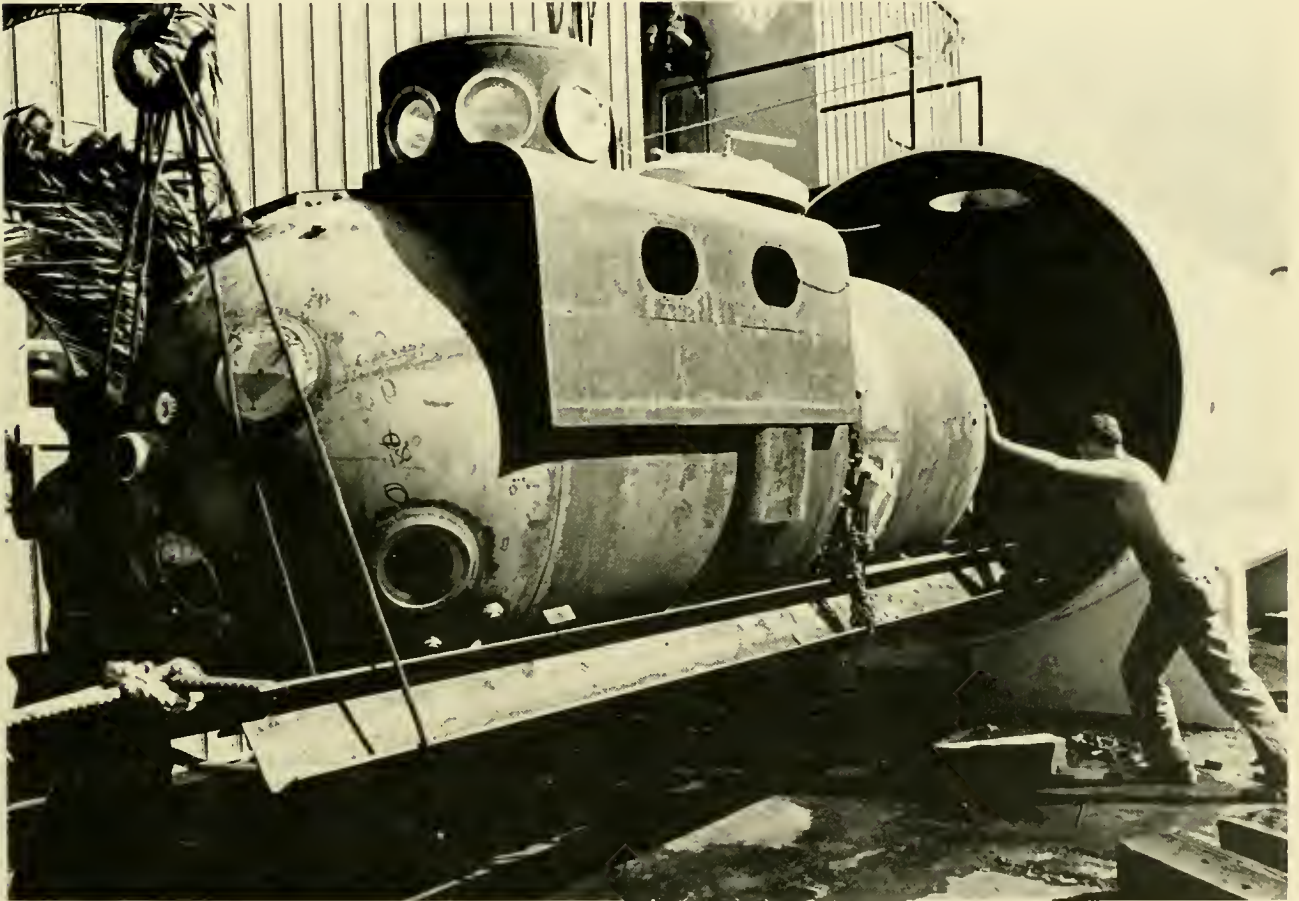

Fig. 5.22 (b) A Perry-built pressure hull entering their test tank. (Perry Submarine Builders)

the many tests and documenting procedures their Undersea Vehicle Safety Standards Committee feels are necessary to assure a safe submersible.

An indication of the myriad tests followed in submersible construction can be attained from the fabrication steps and tests for *ALVIN*'s pressure hull in Table 5.7. At the conclusion of the tests shown in this table, the pressure hull was considered a part of the vehicle system and tested as such.

In the course of the pressure test (step 12 of Table 5.7) on *ALVIN*'s hull, strain gages were employed, but another technique is used by Perry Submarine Builders which follows a volumetric change in the hull. Both techniques will be briefly discussed.

### Strain Gage Measurements

As outlined previously, many known discontinuities are built into the submersible hull, e.g., hatches, viewports, electrical pene-

trations, welds, etc. Such discontinuities are calculable. To a great degree, verifying the analytical stresses calculated at these discontinuities is measured by strain gages. Strain gages consist basically of finely-wound wire (the most modern and sensitive employ printed circuit techniques) attached to the hull where changes in their electrical resistance are measured as pressure strains the hull. The resistance change in the gage is subsequently translated to a change in wire length measured in microinches. The final results are then compared with the calculated results to assure that the latter were not exceeded. Placement of the gages is extremely critical to assure that the tests are valid, and all likely stress areas are measured.

In general, the pressure hull is pressurized externally by some medium (seawater, fresh water) to a proof test pressure (a value calculated in the early stages of design and is

TABLE 5.7 FABRICATION AND TEST STEPS FOR ALVIN'S PRESSURE HULL [FROM REF. (30)]

Step	Inspection and Test
1. Ingot melt	Visual, chemical
2. Roll into slab and flame cut	Visual, ultrasonic
3. Spin into hemisphere	Visual, ultrasonic, temperature
4. Machine internally and mating surface	Dimensional
5. Weld to form sphere	X-Ray, ultrasonic
6. Machine externally	Visual, dimensional
7. Cut insert openings	Dimensional
8. Weld inserts into hull	Visual, X-Ray, ultrasonic Co <sub>60</sub>
9. Clean welds, add hatch, viewports, etc.	Dimensional
10. Paint to prevent corrosion	Visual
11. Prepare for pressure test	Visual, dimensional
12. Pressure test	Visual monitoring of instrumentation
13. Rework and repaint	Visual
14. Mount into exostructure	Visual, dimensional fit



from 1.1 to 1.125 of the vehicle's maximum operating depth). Because the submersible will be subjected to cyclic pressures, a model of it may be subject to cyclic testing where the external pressure in the test chamber usually is held constant, and the pressure is varied within the vehicle's hull. This avoids cycling the test chamber. In submersibles

too large for test chambers strain gages are utilized and read by the occupants during dives. In some cases a few gages may be left on at critical positions and monitored periodically during the vehicle's operations. An example of a strain gage reading and its location is provided in Figure 5.23 from *DSRV-2* tests (37).

STRAIN GAGE LOCATIONS

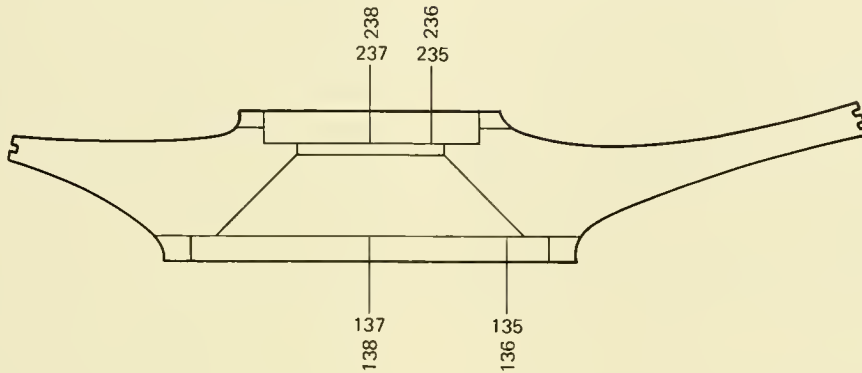

- SYMBOLS ON PLOTS:
- POINTS OF INCREASING PRESSURE
  - POINTS OF RETURN TO ZERO PRESSURE

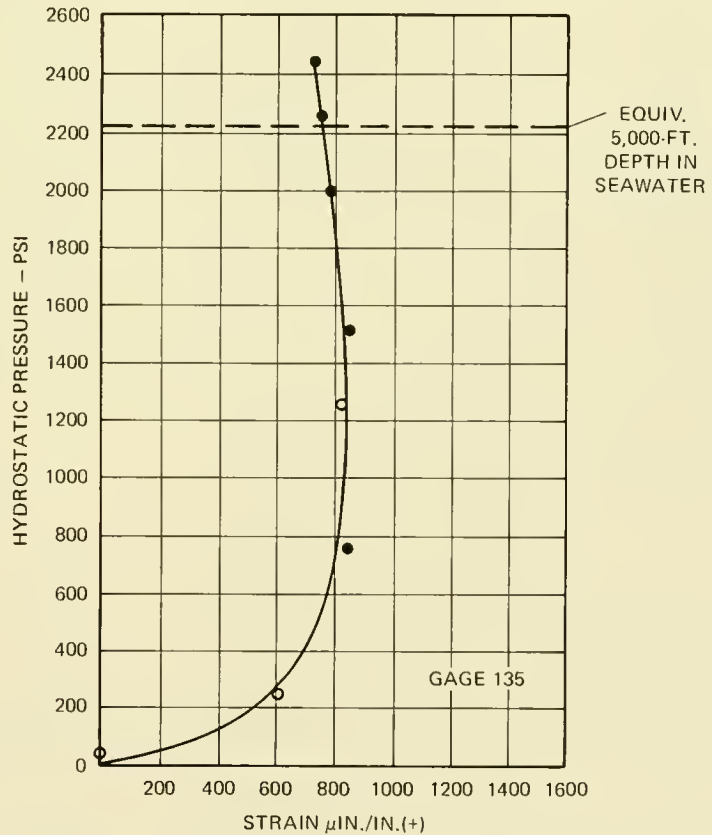

Fig. 5.23 Strain gage readings and location on viewport of DSRV-2.

### Volumetric Measurements

An approach has been taken by Perry Submarine Builders adopted from the Compressed Gas Association which tests gas storage vessels throughout the United States, as well as other internally pressurized systems such as pipelines. In this procedure (31) the pressure hull is filled with water, each com-

partment is sealed pressure tight, and the hull is placed in a pressure tank (Fig. 5.24) which is then flooded and pressurized. Each vehicle compartment contains an efflux line leading through the test tank to a bank of graduated cylinders called volumeters. Small preliminary pressure is applied to force out pockets of air and shake down the system.

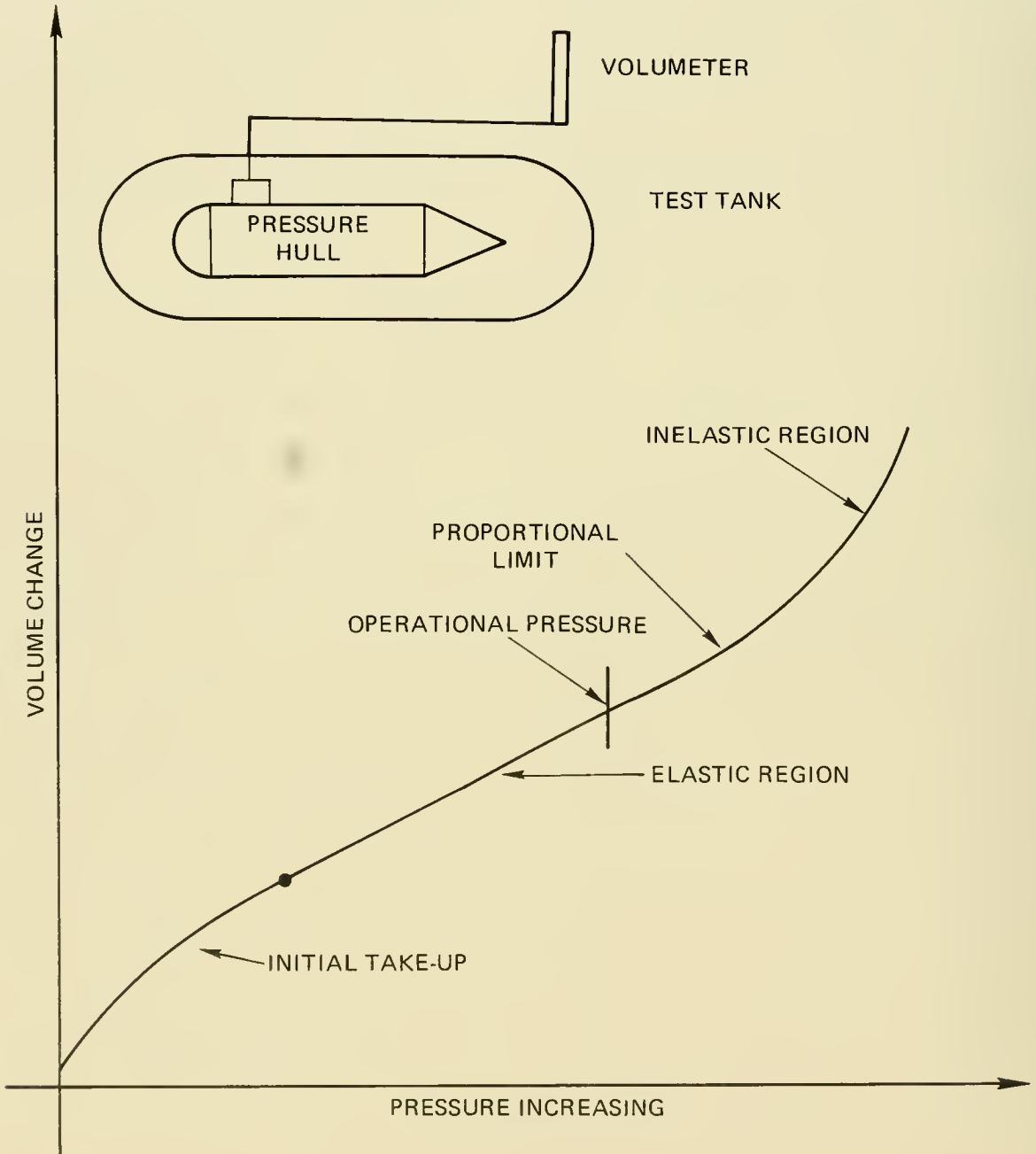

Fig. 5.24 Chart showing pressure-volume change during hydrostatic tank test. (From Perry Submarine Builders)

The pressure is then built up incrementally while the change in volume in the volumeters is recorded. At a pressure point where critical behavior is predicted, the pressure increments are decreased and the test proceeds very slowly while watching for the first sign of a non-linear volume change. When this occurs it is taken to be the onset of a transition from elastic to plastic yield in the hull structure. In the initial development of this technique, strain gages are attached to compare the test results, and to assist in locating the local effects which caused test termination. Without the assistance of strain gages, it would be virtually impossible to tell precisely where the critical stress occurred.

For larger vehicles some measure of the pressure hull behavior is attained through model testing. In this procedure a scale model is constructed in the same fashion and of the same materials as the hull; the model is then subjected to pressure testing in a tank as if it were the full scale hull. Such scale models are occasionally tested to failure as a means of verifying calculations.

Pressure tanks themselves can be extremely complex, sensitive and potentially dangerous. Mavor (32) reported a tank failure at 4,300 psi, with one of *ALVIN's* hulls inside, which blew off a hatch but left the windows undamaged and tight.

Endo and Yamaguchi (33) present an excellent description of pressure and materials testing facilities at Mitsubishi Heavy Industries. The paper is not only a good summarization of the devices available, but includes requirements for deep submergence materials as well.

## CORROSION AND ITS CONTROL

As will become evident in later sections, a great quantity of dissimilar metals are joined and juxtaposed within the exostructure and the pressure hull. Corrosion protection and control is another concern of past and present submersible builders.

Corrosion control on submersibles which are routinely launched/retrieved for each dive is somewhat less complicated than those continuously in the water—mainly because vehicles removed from the sea may be

washed with fresh water and will dry. On the other hand, availability of components and cost result in a situation where less than optimum corrosion resistance and galvanically incompatible materials must be used. Likewise, cathodic protection as a general method often is impractical and difficult owing to the geometrical complexity of components. Though procedures for corrosion control vary from vehicle-to-vehicle, certain problems are common to all. Consequently, the procedures followed in the *DEEPSTAR* submersibles fairly well represent a number of common problems and solutions. Symonds and Woodland (34) present the steps taken to prevent corrosion on *DEEPSTAR 20000* based on 4 years of operational experience with *DEEPSTAR 4000*. These are summarized below.

Four areas of potential corrosion were recognized on the *DS-20000*: General corrosion, galvanic corrosion, crevice corrosion and stress corrosion.

### General Corrosion

Two protective measures were foreseen to prevent general corrosion: Painting and cathodic protection.

#### Painting:

According to *DS-20000's* specifications almost all metallic vehicle components would be painted by a polyurethane paint system known as Magna Laminar X-500. On the pressure sphere, four layers are applied: Wash primer, primer, primer surface and a finish coat. On other components the primer-surface layer is omitted. Where viewports, hatch and electrical penetrators join the hull, two priming layers of the Magna Laminar X-500 are applied and, subsequently, silicone grease is applied during assembly.

#### Cathodic Protection:

A comprehensive cathodic protection system would be impractical owing to the complex geometry which requires placement of a large number of anodes at the sacrifice of weight and space. Because of coating defects, zinc anodes in the form of flexible steel-cored line known as Diamond Line was proposed because its flexibility permits adaptation to a number of complex geometrical situations. Lengths of Diamond Line would be attached

to the four exostructure mounting lugs and at the hatch hinge mounting.

### Galvanic Corrosion

To prevent corrosion caused by the electrochemical reaction between two dissimilar metals in electrical contact with one another, a great deal of effort was made to minimize the area of exposed surfaces by painting them. To prevent galvanic attack on the pressure hull, electrical insulation between it and adjacent titanium alloy structural members was provided in the design. Small lead weights (dropped individually to attain positive buoyancy) are held by steel hooks cast in the top of each weight. To prevent galvanic attack between hook and weight, a plastic sleeve covers each hook.

### Crevice Corrosion

To minimize crevice corrosion, non-draining crevices are kept to a minimum and a thorough fresh water wash down after each dive is specified. Protection of areas impossible to wash is called for as follows: a) Because contact between fairing and metallic exostructure members would be too snug to permit washing, such members would be fabricated from a titanium alloy (Ti-6%, Al-4% V) which is immune from corrosion under such conditions. b) The O-ring groove in an aluminum propulsion controller housing forms a perfect crevice in a corrosion-susceptible material. Hard coat anodizing and sealing of the aluminum and a coating of silicone grease is specified, based on experience with *DEEPSTAR 4000*.

### Stress Corrosion

Components of *DEEPSTAR 20000* which could be stressed under tension were designed so that failure would not occur from stress corrosion crack propagation or corrosion fatigue. Fracture mechanics methods were applied to safeguard against such environmental effects. Fracture mechanics analysis determines if stress corrosion will occur at flaws, e.g., welds, and if such flaws will grow under cyclic loading to a point where stress corrosion will occur. The method works in the following manner: A defect of a particular maximum size is assumed in the component (the limitation of this maximum size is attained from non-destructive testing

of the component) and if, through cyclic loading, this defect will grow to a size where stress corrosion can occur, then the component is unacceptable. *DEEPSTAR 20000*'s variable ballast tanks are composed of titanium (in which crack propagation can proceed at rates of inches/hour), and fracture mechanics showed that 4,000 cycles of loading were required before cracks would grow to a critical depth at which stress corrosion would occur. Similar calculations were made on the pressure hull weldments; they, too, show acceptable limits.

The corrosion control program on *DEEPSTAR 20000* was based primarily on the fact that the vehicle would be taken out of the water following each dive, thus permitting easy field maintenance and repair to chipped paint (the first line of defense against corrosion), etc. Components considered most susceptible to corrosion, and least protectable were designed for easy removal, and spares would be carried for replacement. Such was the case with the cast aluminum alloy propeller blades.

Protective painting, a thorough fresh water washdown, inspection and an onboard inventory of replacement parts constitute the major corrosion control program in submarines today.

In large, complex vehicles where all components are not situated for easy routine maintenance and repair, considerable effort must be expended to combat corrosion. Rynewicz (35) outlines the corrosion control methods in the *DSRV* and the results of test programs leading to these methods. A number of these methods were gained from operating experience (45 dives) with *DEEP QUEST*.

For a thorough and rigorous treatment of the entire scope of materials for ocean engineering, the reader is referred to the work of Koichi Masubuchi (36) who has left no stone unturned in treating materials, fabrication, selection, testing and protection of pressure hulls and associated structures.

### REFERENCES

1. Shankman, A. D. 1968 *Materials for pressure hulls—present and future*. Naval Eng. Jour., v. 80, n. 6, p. 972-979.
2. Link, M. C. 1973 *Windows In The Sea*. Smithsonian Inst., Wash., D.C.

3. Lindberg, R. I. 1968 *ALUMINAUT—Three years later*. Amer. Soc. for Testing and Materials, Sp. Tech. Pub. 445, p. 88-92.
4. Bernstein, H. 1965 *Materials for deep submergence in ocean science and ocean engineering*. Trans. Mar. Tech. Soc., 14-17 June 1965, Wash., D.C., v. 1.
5. Stachiw, J. D. 1971 *Window In The Sea*. Smithsonian Institution Press, Wash., DC., 31 pp.
6. Ottsen, H. 1970 *The Spherical Acrylic Pressure Hull for Hydrospace Application; Part III—Comparison of Experimental and Analytical Stress Evaluations for Prototype NEMO Capsule*. Tech. Note N-1094, Naval Civil Engineering Laboratory, Port Hueneme, Calif.
7. Stachiw, J. D. 1970 *Development of Spherical Acrylic Plastic Pressure Hull for Hydrospace Application*. Tech. Rept. R 676, Naval Civil Engineering Laboratory, Port Hueneme, Calif.
8. Stachiw, J. D. 1970 *The Spherical Acrylic Pressure Hull for Hydrospace Application; Part IV—Cyclic Fatigue of NEMO Capsule #3*. Tech. Note N-1134, Naval Civil Engineering Laboratory, Port Hueneme, Calif.
9. Stachiw, J. D. 1971 *Spherical Acrylic Pressure Hull for Undersea Exploration*. Amer. Soc. of Mech. Engineers, Paper 70-WA/Unt-3.
10. Stachiw, J. D. and Mick, K. L. 1970 *The Spherical Acrylic Pressure Hull for Hydrospace Application; Part II—Experimental Stress Evaluation of Prototype NEMO Capsule*. Tech. Note N-1113, Naval Civil Engineering Laboratory, Port Hueneme, Calif.
11. Kiernan, T. J. and Krenske, M. A. 1968 *Future pressure hulls for deep submergence*. SPE Jour., v. 24, n. 12, p. 56-62.
12. Gross, J. 1969 *Hydrospace steels*. Sci. & Tech., n. 95, p. 4-11.
13. Ballinger, J. M. and Garland, C. (no date) *Some R & D Considerations for Submersible Materials*. Sun Shipbuilding and Dry Dock Co., Rept., Chester, Pa.
14. Stachiw, J. D. 1968 *Plywood hulls for underwater vehicles*. Undersea Tech., Sept., p. 44-45.
15. Stachiw, J. D. 1967 *Concrete pressure hulls for ocean floor installations*. Jour. Ocn. Tech., v. 1, p. 19-28.
16. Opsahl, R. and Terrana, D. B. 1967 *How the PX-15 hull was constructed*. Ocn. Ind., Oct.
17. Covey, C. W. 1964 *ALUMINAUT*. Undersea Tech., Sept., p. 15-23.
18. Rockwell, P. K., Elliott, R. E. and Snoey, M. R. 1971 *NEMO A New Concept in Submersibles*. Naval Civil Engineering Laboratory, Tech. Rept. R. 749, 68 pp.
19. Forman, W. R. 1969 *Submersibles with transparent structural hulls*. Astronautics & Aeronautics, Apr., p. 38-43.
20. Bynum, D. J. and DeHart, R. C. 1963 *Experimental Stress Analysis of a Model of the ALVIN Hull*. Southwest Res. Inst. Rept.
21. DeHart, R. C. 1969 *External-pressure structures*. Handbook of Ocean and Underwater Engineering. McGraw-Hill Book Co., New York, p. 9.1-9.20.
22. Snoey, M. R. and Stachiw, J. D. 1968 *Windows and transparent hulls for man in hydrospace*. Mar. Tech. Soc. Trans., 4th Ann. Conf. Exhibit, 8-10 July, p. 419-463.
23. Lankes, L. R. 1970 *Viewing Systems for Submersibles*. Optical Spectra, May, p. 62-67.
24. Edgerton, H. E. 1967 *The instruments of deep-sea photography*. Deep-Sea Photography, The Johns Hopkins Press, Baltimore, Md., p. 47-54.
25. Dunn, G. M. and Stachiw, J. D. 1966 *Acrylic windows for underwater structures*. Photo-Optics Seminar at Santa Barbara, Calif., Oct. 11, Soc. of Photo-Optical Instrumentation Engineers.
26. Snoey, M. R. and Katona, M. G. 1970 *Structural Design of Conical Acrylic Viewports*. Naval Civil Engineering Laboratory Tech. Rept. R. 686, 57 pp.
27. Purcell, J. and Kriedt, F. 1969 *Oxygen systems monel vs. stainless steel*. Paper presented at the 6th Ann. Tech. Sym. of the Assoc. of Senior Engineers, Naval Ship Systems Command, Wash., D.C.
28. Penzias, W. and Goodman, M. W. 1973 *Man Beneath the Sea*. Wiley and Son, Inc., New York, 831 pp.

29. Allnutt, R. B. 1972 *Deep Sea Simulation Facilities*. Naval Ship Research & Development Center, Bethesda, Md., Rept. 3825 (unpub. manuscript).
30. Marine Technology Society 1968 *Safety and Operational Guidelines for Undersea Vehicles*. Mar. Tech. Soc., Wash., D.C.
31. Crawford, B. 1971 *A volumetric technique for evaluating pressure vessels*. Mar. Tech. Soc. Jour., v. 5, n. 5, p. 7-13.
32. Mavor, J. W., Jr. 1966 *Observation windows of the deep submersible ALVIN*. Jour. Ocn. Tech., v. 1, n. 1, p. 2-16.
33. Endo, M. and Yamaguchi, T. 1972 *Testing facilities for research and of deep submergence vessels*. Reprints The 2nd International Ocn. Dev. Conf., Tokyo, v. 1, p. 870-894.
34. Symonds, J. and Woodland, B. T. 1970 *Corrosion protection on DEEPSTAR submersibles*. Reprints of the 6th Ann. Conf. and Expo., Mar. Tech. Soc., June 29-July 1, Wash., D.C., v. 2, p. 1233-1245.
35. Rynewicz, J. F. 1970 *Corrosion control for the DEEP SUBMERGENCE RESCUE VEHICLE*. Reprints of the 6th Ann. Conf. and Expo., Mar. Tech. Soc., June 29-July 1, Wash., D.C., v. 2, p. 1247-1263.
36. Masubuchi, K. 1970 *Materials for Ocean Engineering*. M.I.T. Press, Cambridge, Mass., 496 pp., 1 Appendix.
37. Senos, J. J. 1971 *1/2 Scale Model Test of DSRV Pressure Hull*. Naval Ship Research & Development Center Rept. No. 352B, Jan.



# 6

## BALLASTING AND TRIM SYSTEMS

In addition to descending to the bottom, ascending to the surface and running hither and yon, submersibles must make small adjustments in buoyancy and trim when submerged. Such changes serve the following purposes: To follow a sloping bottom, to handle additional weight in the form of water or biological/geological samples, and to surface with sufficient freeboard for safe transfer of personnel and equipment. All of these functions are performed by changes in the vehicle's buoyancy or trim. The approaches to buoyancy and trim control are many, and most are successful. In some cases trim changes are accomplished dynamically with the vehicle's thrusters and dive planes. But use of thrusters calls for electrical power

which is limited, and attitude changes using dive planes require that the submersible be underway, a condition not always compatible with the mission.

The nature and capacity of a ballasting system depend upon several factors, but the total submerged displacement of the vehicle and the desired payload assume primary importance. Other considerations might include desired reaction time of buoyancy changes and the anticipated number of cycles such changes may require on one dive.

### WEIGHT AND VOLUME ESTIMATES

As a first approximation, the designer may

prepare a form which groups together:

**Structures:** Pressure hull, exostructure, fairings;

**Propulsion and Electrical Plants:** Propellers, thrusters, batteries;

**Communication and Control:** Underwater telephone, steering controls, radio;

**Auxiliary Systems:** High pressure air, ballasting, life support;

**Outfit and Furnishings:** Hull fitting, chairs, paint;

**Crew and Instrumentation:** Crew, scientific and operational instruments, tools.

An estimate is made of the weight, displacement volume and centers of gravity and buoyancy of each item within the preceding group. When such calculations are made, the elements of the vehicle must be adjusted in size and placement until two conditions are

nearly met: 1) The sum of all weights must be equal to the weight of the water displaced by all buoyant volumes; and 2) the resultant center of gravity of all weights must be below and in a vertical line with the resultant center of buoyancy.

Rechnitzer and Gorman (1) treat in detail the procedures for calculating submerged displacement of various components and housings used in submersibles. Final adjustment to attain neutral submerged buoyancy is made with fixed, positive (*e.g.*, syntactic foam) ballast or fixed negative (*e.g.*, lead weights) ballast either inside or outside the pressure hull.

Vincent and Stavovy (2) present figures for the average weight of components within the preceding list; these are as follows:

Structures 65%

TABLE 6.1 PRELIMINARY WEIGHT AND BUOYANCY ESTIMATES

Description	Weight Pounds	Vert Ref = B.L.		Long Ref = F.P.		Buoyancy (Pounds) Seawater	Vert Ref = B.L.		Long Ref = F.P.	
		VCG (In.)	Moment (In. - Lb)	LCG (In.)	Moment (In. - Lb)		VCB (In.)	Moment (In. - Lb)	LCB (In.)	Moment (In. - Lb)
Main Sphere (Steel)	2,590	55	142,450	58	150,220	9,210	55	506,550	58	534,180
Main Sphere (Acrylic)	2,280	55	125,400	58	132,240	9,210	55	506,550	58	534,180
L - O Sphere	1,960	61	119,560	178.5	349,860	5,870	61	358,070	178.5	1,047,795
Variable Ballast Sphere	330	53	17,490	118	38,940	640	53	33,920	118	75,520
Ballast Air Bottles	680	62	42,160	140	95,200	535	62	33,200	140	75,000
Breathing Air Bottles	680	61	41,480	153	104,040	535	61	32,620	153	81,900
Battery Box Top	2,590	86	222,740	119	308,210	1,000	86	86,000	119	119,000
Battery Box Bottom	2,550	25	63,750	121	308,550	1,000	25	25,000	121	121,000
Prop Pods	900	60	54,000	116	104,400	130	60	7,800	116	15,080
Drop Weight	550	13	7,150	58	31,900	50	13	650	58	2,900
Fairing	1,200	54	64,800	112	134,400	480	54	25,900	112	53,800
Framing	1,250	54	67,500	112	140,000	20	54	1,080	112	2,240
Int. Equipment (Mn Sph)	1,200	55	66,000	58	69,600	-	-	-	-	-
Int. Equipment (L - O Sph.)	300	61	18,300	178.5	53,550	-	-	-	-	-
Hatches & Inserts (L - O)	800	32	25,600	178.5	142,800	40	32	1,280	178.5	71,400
Payload										
Steel Sphere	2,100	51.5	108,000	89.5	2,219,670	170	51.5	8,750	89.5	15,200
Acrylic Sphere	1,450	45	65,300	100	2,220,180	120	45	5,400	100	12,000
Totals										
Steel Sphere	19,680	54	1,060,980	112.5	2,219,670	19,680	57	1,120,820	112.5	2,215,015
Acrylic Sphere	19,630	54	1,060,110	112.5	2,220,180	19,630	57	1,117,470	112.5	2,211,815

B.L. - Base Line

F.P. - Forward Perpendicular

VCG - Vertical Center of Gravity

LCG - Longitudinal Center of Gravity

VCB - Vertical Center of Buoyancy

LCB - Longitudinal Center of Buoyancy

L.O. - Lock-out



Propulsion and Electrical Plants	13%
Communication and Control	3%
Auxiliary Systems	14%
Outfit and Furnishings	1%
Crew and Instrumentation	4%

Obviously, these percentages are generalities and cannot be applied to a specific vehicle. The most perplexing values to attain are those for instruments which vary widely

from one manufacturer to the next. Chapter 11 presents weight and size data for selected scientific instrumentation and essentially reflects current state-of-the-art. Table 6.1 presents calculations prepared for a vehicle proposed by International Hydrodynamics and serves as an example of the data needed for weight, volume and buoyancy calculations.

A further example of the complexity involved in building and "sizing" a submers-

TABLE 6.2 ALUMINAUT CONTRACTORS

Southwest Research Institute San Antonio, Texas	Initial feasibility study in 1958-1959, with Reynolds.	Curtis Manufacturing Co. Bunnell Division Cleveland, Ohio	Steering and diving mechanisms and special tools.	Modern Metals Manufacturing Co. New York, N.Y.	Fabrication and manufacturing of electrical panels and boxes.
Electric Boat Division, General Dynamics Groton, Conn.	Prime contractor for design and building vessel.	Danko-Arlington, Inc. Baltimore, Md.	Castings.	Marotta Valve Corp. Boonton, New Jersey	Water ballast valves.
Reynolds Metals Co. Sheet and Plate Works McCook, Illinois	Cast aluminum ingots for hull sections.	DeLackner Helicopters, Inc. Mt. Vernon, N.Y.	Precision hull studs, propulsion gear boxes and emergency drop.	Northrop Nortronics Precision Products Norwood, Mass.	Speed and distance navigation equipment.
Ladish Company Cudahy, Wisc.	Forging and shaping of hull sections.	Edgerton, Germeshausen & Grier, Inc. Boston, Mass.	Underwater lights and TV equipment.	Oceanographic Engineering Corp. La Jolla, Calif.	Pan and tilt control system.
Nordberg Manufacturing Co. Milwaukee, Wisc.	Precision machining and assembly of hull sections.	Exide Industrial Div. Electric Storage Battery Philadelphia, Pa.	Silver-zinc batteries.	Ocean Research Equipment, Inc. Falmouth, Mass.	High pressure testing.
<b>Equipment and Service Suppliers</b>		Feedback Controls, Inc. Natick, Mass.	Dead reckoning analyzer.	Bliss-Portland Division of E. W. Bliss Co. South Portland, Me.	Fabrication of keel, ballast tanks, stern and superstructure.
Acme Electric Corp. Cuba, New York	Electrical transformers.	General Electric Co. Erie, Pa.	Propulsion and steering motors and manipulator.	Sangamo Electric Co. Springfield, Ill.	Amp-hour meters.
Aero Industries, Inc. Greenwich, Conn.	Pilot's chair.	International Resistance Co. Philadelphia, Pa.	Remote indicating systems.	Sperry Piedmont Co. Charlottesville, Va.	Gyrocompass.
Alloy Flange & Fitting Corp. Brooklyn, New York	Flanges and fittings.	Kaar Engineering Corp. Palo Alto, Calif.	Radio-telephone communications.	Stevens Institute of Technology Hoboken, New Jersey	Hydrodynamic studies.
Amchien Products, Inc. Bristol, Conn.	Special finish for aluminum.	G. W. Lisk Company Clifton-Springs, N.Y.	Ballast control solenoids.	Straza Industries El Cajon, Calif.	CTFM scanning sonar, and underwater phone.
Bonney, Forge & Tool Works Allentown, Pa.	Fittings.	Lord Manufacturing Co. Erie, Pa.	Vibration and shock isolation equipment.	Trident Engineering Associates Annapolis, Md.	Engineering study of sea support systems.
Clearfloat, Inc. Attleboro, Mass.	Viewing port windows.	Magna Coating & Chemicals Corp. Los Angeles, Calif.	Special finish for aluminum.	Triton Marine Products Port Washington, New York	Depth sounder-receiver, transmitter, recorder.
Cohu Electronics, Inc. Kintel Division San Diego, Calif.	Miniaturized TV camera and monitors.	Marsh & Marine Manufacturing Co. Houston, Texas	Hull penetrating connectors and underwater cable.	Westinghouse Electric Undersea Division Baltimore, Md.	Bottom scanning sonar.
Cosmos Industries, Inc. Long Island City, New York	Navigation equipment.	Michigan Wheel Co. Grand Rapids, Mich.	Propellers.		

ible is seen in Table 6.2, taken from reference (3), which shows the numerous subcontractors the prime contractor dealt with at various stages in development and fabrication of **ALUMINAUT**.

## COMPRESSED AIR AND DEBALLASTING

The most universally applied power source on submersibles to empty the main or variable ballast tanks of water is compressed air. However, compressed air is useful only to certain depths where the volume and pressure required to store it is practical, and where its density under pressure provides effective buoyancy. In many vehicles variable ballast tanks are pumped dry; in this case, the tanks must be able to withstand ambient pressures. The following discusses the application of compressed air for water deballasting.

A discussion of compressed air is virtually impossible without defining certain terms. The following are taken from the U.S. Navy Diving Manual.

**Gage Pressure (psig):** The difference between the pressure being measured and the surrounding atmospheric pressure. The zero on ordinary gages indicates atmospheric pressure and, except where otherwise specified, almost all pressure readings are gage pressure. When the pressure in a tank is given as 1,000 psi, this means it is 1,000 psi above atmospheric pressure. When it is desirable to indicate that a pressure is gage, it is customary to express it as **pounds per square inch, gage (psig)**. Gage pressure is a commonly used expression in the submersible field, although many manufacturers do not state psig.

**Absolute Pressure (psia):** The true or total pressure being exerted, consisting of the gage pressure plus 1 atmosphere of pressure (14.7). Absolute pressure is commonly expressed as **pounds per square inch, absolute (psia)** and this value is always used in equations describing gas behavior.

**Standard Temperature and Pressure (STP):** The volume a gas occupies at 14.7 psia and 32°F (760 mm Hg absolute; °C). Under these conditions is derived a **Standard Cubic Foot (SCF)**.

**Normal Temperature and Pressure (NTP):** The volume occupied by a gas at 14.7 psia and 68°F. "Normal" is a relative term and can also be taken at 70° or 72°F.

In addition to the above terms are two gas laws which describe the behavior of air under varying conditions:

**Boyle's Law** states that *if the temperature is kept constant, the volume of gas will vary inversely as the absolute pressure while the density will vary directly as the pressure.*

**Charles's Law** states that *if the pressure is kept constant, the volume of a gas will vary directly as the absolute temperature.*

These two laws are combined to relate pressure, volume and temperature in a general gas law expressed as:

$$\frac{P_1 V_1}{T_1} = \frac{P_2 V_2}{T_2}$$

where:

- $P_1$  = initial pressure (absolute)
- $V_1$  = initial volume
- $T_1$  = initial temperature (absolute)

and

- $P_2$  = final pressure (absolute)
- $V_2$  = final volume
- $T_2$  = final temperature (absolute)

The air supply for blowing water ballast is carried aboard submersibles in cylindrical containers referred to as either **tanks, flasks or bottles**. These tanks may be made of an aluminum alloy, steel or other special materials. The capacity (generally expressed in cubic feet) of such tanks is the amount of air or gas the tank holds when charged to its rated pressure. The rated pressure (also called "service pressure" or "working pressure") is the internal pressure to which the tank can be repeatedly filled without causing abnormal metal fatigue. In the U.S., the Department of Transportation maintains regulations for design and manufacture of high pressure cylinders, and, if made of steel, their pressure rating is stamped on the cylinder. Cylinders with pressure ratings of 1,800 to 5,000 psig are available, but 2,400 psig and 3,000 psig are most common. A 70-ft<sup>3</sup> tank, for example, filled to its rated 2,250 psig would contain sufficient air to fill an enclosure of 70-ft<sup>3</sup> volume at a pressure of 14.7 psi; the actual physical volume of the tank would be about 2 ft<sup>3</sup>.

High pressure gas (air) cylinders are generally hydrostatically tested at 1.5 or 1.66 times their rated pressure and may have a burst pressure of 2 to 4 times the rated. A safety release device is usually required in these tanks.

Another safety precaution in the handling of compressed air, or any gas, is color coding the tank. Although submersible owners are not required to abide by any particular coding system, and few do, both the American Bureau of Shipping and the U.S. Naval Material Command recommend that a color code be followed as presented in Table 6.3.

The amount and service pressure of air carried aboard submersibles varies considerably and depends upon the depth from which the water ballast is to be operated and the volume of the ballast tanks.

Virtually all vehicles diving to 2,000 feet or less use compressed air to blow main and variable ballast. Quite frequently both a high and low pressure system are employed: The low pressure to blow main ballast at the surface, and the high pressure to blow main ballast in an emergency or the variable ballast tanks when submerged. For example, *BEN FRANKLIN* uses a 1,422-psi low pressure system to blow main ballast on the surface and a 2,874-psi system to blow main ballast at 2,000 feet in an emergency.

As mentioned, the service pressure of ballast blow tanks varies widely from vehicle-to-vehicle. The 150-ft depth vehicle of All Ocean Industries carries 40 ft<sup>3</sup> of compressed air in two diver-type scuba tanks at 2,250 psi; the 15,000-ft *ALUMINAUT* carries a 4,500-psi supply of air which is used to blow water ballast to 4,000 feet in the event of an emergency.

When air is used to force water ballast out of a tank in open communication with ambient seawater, its effectiveness as both a deballasting and buoyant force is a function of depth (pressure) and temperature. It is in this context that air shall be considered in the following. From Chapter 2 it was seen that pressure increases at a rate of 14.7 psi with every 33 feet of depth. Temperature, on the other hand, decreased with depth at a rate dependent upon geographic location and time of year. To force water out of a ballast tank into the sea with compressed air, the air must exert a pressure exceeding that of the surrounding water. Having removed this water, the weight of the vehicle is now much less and the vehicle attains a buoyant upward force, but air under seawater pressure is of greater density than air at atmospheric pressure and this density must be taken into account when employing an air deballasting scheme.

TABLE 6.3 RECOMMENDED COLOR CODING IN PIPING AND COMPRESSED GAS CYLINDERS

Gas	Designation		Color Paint	
	ABS	USN	ABS	USN
Air (low or high pressure)	ALP, AHP	ALP, AHP	Black	Black
Helium	He	He	Buff	Buff
Oxygen	O	O	Green	Green
Helium-Oxygen Mix	He-O	He-O	Orange	Buff and Green
Nitrogen	N	N	Light Gray	Light Gray
Exhaust	E	E	Silver	Silver
Hydrogen	H	H	Yellow	Brown

Examining Table 6.4, it is seen that air under a pressure of 4,498 psia (10,000 ft) and 70°F has a density of 20.59 pcf (pounds per cubic foot), and at 2,246 psia (5,000 ft) and 70°F its density is almost half this or 11.43 pcf. Seawater has an average density of 64.4 pcf; air at 4,498 psia is approximately  $\frac{1}{3}$  as dense as seawater, whereas air at 2,246 psia is about  $\frac{1}{6}$  its density; hence, air's ability to provide a buoyant force decreases with increased depth or pressure. At much greater depths the density of air can reach that of seawater where it supplies no lift whatever.

Boyle's law states, in part, that *the volume of a gas will vary inversely as the absolute pressure*; in other words, the greater the pressure the less the volume. This is another major factor influencing the use of compressed air for water deballasting. For example, Fig. 6.1 shows the interior of the *AUGUSTE PICCARD* with the tanks holding compressed air for blowing main ballast affixed port and starboard to the top of the

hull. There are 42 air tanks of 1.67-ft<sup>3</sup> volume each which are charged to a working pressure of 3,570 psia. The main ballast tanks on this vehicle, of which there are 12, have a total capacity of 842.5 ft<sup>3</sup>. If the entire air supply was used to blow ballast at 2,500 feet (1,127.5 psia), 221.6 ft<sup>3</sup> of water would be displaced; in order to completely empty the main ballast tanks, almost four times the number of air tanks now carried would be required. In short, the mere physical requirements of the air tanks to blow water ballast at great depths would be unacceptable on a weight and volume basis alone in present submarines. Additionally, the air itself in these tanks would weigh in the neighborhood of 1,206 pounds (70°F; 3,570 psia), which is in excess of the payload in most currently operating vehicles. In spite of the disadvantages noted, compressed air remains the chief source of water deballasting and buoyancy in the majority of shallow-diving vehicles.

TABLE 6.4 AIR DENSITY (PCF) AS A FUNCTION OF PRESSURE AND TEMPERATURE\*

Depth (Ft)	Pressure		Temperature (°F)							
	PSIA	ATM	30	40	50	60	70	80	90	100
0	14.70	1.00	00.08	00.08	00.08	00.08	00.08	00.07	00.07	00.07
100	59.14	4.02	00.33	00.32	00.31	00.31	00.30	00.30	00.29	00.29
200	103.58	7.05	00.57	00.56	00.55	00.54	00.53	00.52	00.51	00.50
300	148.03	10.07	00.82	00.80	00.79	00.77	00.76	00.74	00.73	00.72
400	192.47	13.10	1.07	1.05	1.03	1.01	00.99	00.97	00.95	00.93
500	236.92	16.12	1.32	1.29	1.26	1.24	1.21	1.19	1.17	1.15
600	281.36	19.15	1.57	1.54	1.50	1.47	1.44	1.42	1.39	1.36
700	325.80	22.17	1.82	1.78	1.74	1.70	1.67	1.64	1.61	1.58
800	370.25	25.19	2.07	2.03	1.98	1.94	1.90	1.86	1.83	1.79
900	414.69	28.22	2.32	2.27	2.22	2.17	2.13	2.09	2.04	2.01
1000	459.14	31.24	2.58	2.52	2.46	2.41	2.36	2.32	2.27	2.23
1500	681.36	46.36	3.85	3.76	3.67	3.59	3.52	3.44	3.37	3.31
2000	905	61.58	5.14	5.01	4.90	4.79	4.68	4.58	4.49	4.39
3000	1351	91.86	7.70	7.50	7.32	7.15	6.98	6.82	6.68	6.53
4000	1798	122.47	10.24	9.97	9.72	9.48	9.25	9.03	8.83	8.64
5000	2244	152.83	12.71	12.34	12.02	11.72	11.43	11.16	10.91	10.67
6000	2695	180.32	14.99	14.58	14.20	13.85	13.51	13.19	12.89	12.61
7000	3144	213.93	17.14	16.67	16.25	15.89	15.46	15.10	14.76	14.43
8000	3594	244.62	19.11	18.62	18.16	17.71	17.30	16.90	16.53	16.17
9000	4046	275.30	20.94	20.41	19.92	19.44	19.00	18.57	18.17	17.92
10,000	4498	306.08	22.62	22.07	21.53	21.06	20.59	20.14	19.71	19.31

\*Taken, in part and extrapolated, from the U.S. Navy Diving-Gas Manual, U.S.N. Supervisor of Diving, Research Rept. No. 3-69, 1 Oct., 1969, by Bateele Mem. Inst.

## BALLASTING SYSTEMS

At least 13 systems can be identified which are used to provide positive, negative and neutral buoyancy in submersibles. These range from venting and blowing steel tanks to merely hanging a cable on the vehicle and letting it drag along the bottom. Three methods of buoyancy control common to almost half of the past and present submersibles consist of a positively buoyant pressure hull; a main ballast (MBT) system to attain surface buoyancy and possibly negative descent buoyancy; and a variable ballast (VBT) system to attain small changes in buoyancy when submerged. In addition to these three methods there are a number of others designed to accomplish the same results but in different ways (Table 6.5).

One method used to gain negative buoyancy is the addition of lead or steel ballast to the vehicle based on post-construction calculations and/or sea trials. Although normally used for minor weight adjustments, such weight may be made jettisonable and thus serves an emergency role.

Ballasting systems are classified herein as Reversible and Irreversible—the distinction being that reversible systems are capable of providing at least one positive and negative cycle during a dive and Irreversible systems provide only a one-time, one-way function. For example, ascent and descent ballasting systems assist the vehicle to dive and then ascend and, therefore, provide both negative and positive buoyancy. Syntactic foam provides the vehicle with positive buoyancy only. The problem with this classification can



Fig 6.1 Interior of *AUGUSTE PICCARD*. Overhead rows of cylindrical tanks port and starboard hold a total of 842.5 cubic feet of compressed air for blowing main and variable ballast.

TABLE 6.5 SUBMERSIBLE BALLAST AND BUOYANCY METHODS

Submersible	Depth (ft)	Ascent/ Descent			Anchor	Cable	Pres- sure Hull	Syn- tactic Foam	Hard Tanks	Inflat- able Bag	Small Weight Drop	Steel Shot	Gaso- line
		MBT	VBT <sup>1</sup>	VBT <sup>2</sup>									
HIKINO	20	•					•						
GOLDFISH	100	•	•				•						
NAUTILETTE	100	•					•						
ALL OCEAN INDUSTRIES	150	•					•						
PC3-X	150	•	•				•						
PORPOISE	150	•											
STAR I	200	•	•				•						
SUBMANAUT (Helle)	200		•				•						
K-250	250		•				•						
MINI DIVER	250	•		•			•						
SPORTSMAN 300	300	•	•				•						
SUBMARAY	300	•	•				•						
KUMUKAHI	300		•				•						
PC-3A1	300	•	•				•						
PC-3A2	300	•	•				•						
NEREID 330	330	•	•				•						
SEA RANGER	600												
SPORTSMAN 600	600	•	•				•						
SUBMANAUT (Martine)	600	•	•				•						
TECHDIVER	600	•	•				•						
ASHERAH	600	•	•				•						
BENTHOS V	600		•				•		•				
MAKAKAI	600		•				•						
NEMO	600	•			•		•						
PAULO I	600	•					•						
SURV	600	•	•				•						
KUROSHIO II	650	•	•				•						
NEREID 700	700	•					•						
PC-8	800						•						
SHELF DIVER	800	•	•				•						
YOMIURI	972	•					•						
MERMAID I/II	984	•	•				•						
MERMAID III/IV	984	•	•				•						
HAKUYO	984	•	•				•						
TOURS 64	984	•					•						
TOURS 66	984	•					•						
GUPPY	1000	•					•					•	
NEKTON ALPHA	1000	•	•				•						
NEKTON BETA	1000	•	•				•						
NEKTON GAMMA	1000	•	•				•						
SEA-RAY	1000		•				•						
SEA LINK	1000	•	•				•						
SNOOPER	1000	•					•						
PS-2	1025	•					•						
PISCES I													
STAR II	1200	•	•				•	•					
AQUARIUS	1200	•					•						
VOL-L1	1200	•	•				•						

TABLE 6.5 SUBMERSIBLE BALLAST AND BUOYANCY METHODS (Cont.)

Submersible	Depth (ft)	MBT	VBT <sup>1</sup>	VBT <sup>2</sup>	Ascent/ Descent Weights	Anchor	Cable	Pres- sure Hull	Syn- tactic Foam	Hard Tanks	Inflat- able Bag	Small Weight Drop	Steel Shot	Gasoline
PC5C	1335	•	•					•						
SURVEY SUB I	1350	•	•					•						
DEEP DIVER	1350	•	•					•						
SP-350	1350		•		•			•						
SEA OTTER	1500	•	•					•						
DEEP VIEW	1500							•	•			•		
SP-500	1640		•		•							•		
SP-500	1640		•		•							•		
PISCES I	1200	•		•				•						
SHINKAI	1968	•	•					•						
ARGYRONETE	1970	•	•					•						
GRIFFON	1970	•	•			•								
BEN FRANKLIN	2000	•	•				•	•	•				•	
SDL-1	2000													
BEAVER	2000	•	•			•		•						
DEEP JEEP	2000							•	•	•(-)		•		
DEEP STAR 2000	2000	•		•		•(-)		•	•	•(+)				
STAR III	2000	•	•					•	•					
AUGUSTE PICCARD	2500	•	•					•					•	
PISCES II	3000	•		•				•						
PISCES III	3000	•		•				•						
DSRV-1	3500	•	•					•		•	•			
DEEPSTAR 4000	4000	•		•	•			•	•	•(-)		•		
DSRV-2	5000	•	•					•		•	•			
TURTLE	6500	•		•				•						
SEA CLIFF	6500	•		•				•						
PISCES IV	6500	•		•				•						
PISCES V	6500	•		•				•						
PISCES VI	6500	•		•				•						
DQWB	6500	•		•				•						•
DEEP QUEST	8000	•	•					•	•				•	
SP-3000	10082				•			•		•(-)		•		
ALVIN	12000			•	•			•	•	•				
FNRS-2	13500						•						•	•
FNRS-3	13500						•						•	•
ALUMINAUT	15000	•						•					•	
DEEPSTAR 20000	20000	•		•	•			•	•					
TRIESTE II	20000						•						•	•
TRIESTE III	20000												•	•
TRIESTE	36000												•	•
ARCHIMEDE	36000						•						•	•

VBT<sup>1</sup>=Hard Tanks and Seawater

VBT<sup>2</sup>=Hard/Soft Tanks (Dil)

(-)=Negative Buoyancy

(+)=Positive Buoyancy

be seen with the dropping of small weights which serve, primarily, to make the submersible lighter, but also served, initially, to provide sufficient negative buoyancy to allow it to descend; the same may be said of iron shot. A further distinction, then, between the two systems is that they are grouped according to their *primary* ballasting function.

Chapter 14 deals with other ballasting devices in the form of an emergency weight which is dropped to provide positive buoyancy. Because these methods are not routinely employed, it will suffice to note that they constitute another means of gaining positive buoyancy.

The following descriptions of various ballasting/deballasting devices are brief by necessity, for only a handful of vehicles, *e.g.*, the *PISCES* series, use similar procedures and components. Individual descriptions of each vehicle's ballasting system is provided in Chapter 4. Most of the systems perform essentially the same function from vehicle to vehicle. Consequently, a general description of the system's function, location, configuration, etc., where it is amenable to this format, is presented. The examples cited are selected to include one system which is fairly representative of all, or one that represents an advancement over or significant departure from the general field.

The capacity of main ballast tanks varies from vehicle-to-vehicle and is not controlled by any standards. The Marine Technology Society recommends that main ballast tank capacity should not be less than 10 percent of the vehicle's displacement at normal diving trim. The American Bureau of Shipping, on the other hand, does not require a minimum capacity, but must be satisfied that the vehicle can stay on the surface without endangering the safety of the vessel under normal sea conditions (Sea State 3 or as defined by the designer) and with adequate freeboard. In most vehicles the 10-percent displacement margin is generally attained or exceeded.

## Reversible Systems

### Main Ballast Tanks:

**Function:** To provide large changes in positive and negative buoyancy and provide ade-

quate freeboard for maneuvering and for the ingress/egress of personnel to the pressure hull.

**Operation:** On the surface the MBT's are empty. Vent valves are located at the top of the tanks and flood valves at the bottom; the latter may or may not be free flooding. To dive the vent valves are opened by the operator and seawater flows in through the flood openings forcing air out through the top. In the majority of vehicles an indicator light or dial warns when the MBT's are fully flooded, at which time the vent valves are closed. When the MBT's are full, the submersible may be at neutral buoyancy or slightly negative and begins to descend. If the former is the case, smaller capacity variable ballast tanks are flooded or releasable weights are added to provide negative descent buoyancy. In a few submersibles, the MBT's can be fully blown at operating depth; in the majority, the MBT's are not blown until the vehicle reaches the surface where additional freeboard is required. In all vehicles, compressed air is used to blow the MBT's when surfaced.

**Location:** MBT's generally straddle the pressure hull and are located as high on the vehicle as practical to provide stability when surfaced by raising the center of buoyancy in respect to the center of gravity.

**Configuration:** Virtually any configuration is acceptable which is compatible with the pressure hull shape and offers least hydrodynamic drag.

**Material:** Steel of various compositions, fiberglass, aluminum. Material whose strength is sufficient to withstand wave slap and the rigors of shock during transport and at-sea handling.

### Example:

a) The submersible *BEN FRANKLIN* has four MBT's which straddle the pressure hull fore and aft (Fig. 6.2) and provide approximately 18 inches of freeboard when dry. The tanks are constructed of laminated-polyester and fiberglass,  $\frac{1}{4}$  to  $\frac{3}{8}$  inch thick, and contain 11 fiberglass ribs (filled with syntactic foam) spaced within each tank to provide additional strength. Each tank has a capacity of 162 ft<sup>3</sup> and all four provide approximately 41,500 pounds of positive buoy-



ancy when dry. The tanks are designed to withstand 1,000-psf wave slap with a safety factor of 2. At 2,000-ft depth 50 percent of the flooded tank can be blown for emergency ascent only. Six free-flooding openings are in the bottom of each tank and a solenoid-operated vent valve is located on the top and at the rear of each tank. To dive, the solenoids are activated and open the vent valves; this allows water to enter the bottom and an indicator light informs the operator when the tanks are full. The valves shut at any time the operator releases the vent switch. With the MBT's fully flooded, the vehicle is at approximate neutral buoyancy and addi-

tional ballast causes it to descend. To blow the tanks dry, high pressure air (2,844 psi) is used and stored in six flasks mounted port and starboard between the deck and MBT's. Each side has a flask of 21-, 7- and 5-ft<sup>3</sup> capacity each holding 262, 125 and 88 pounds of air, respectively. Each flask is piped through its own hull valve, pressure gage and control valve and then grouped near the operator's console where they are manifolded together and fed through a single pressure reducer (1,422 psi) for normal blowing operations. In the event of an emergency, the relief valve can be bypassed and high pressure air (2,844 psi) fed directly to

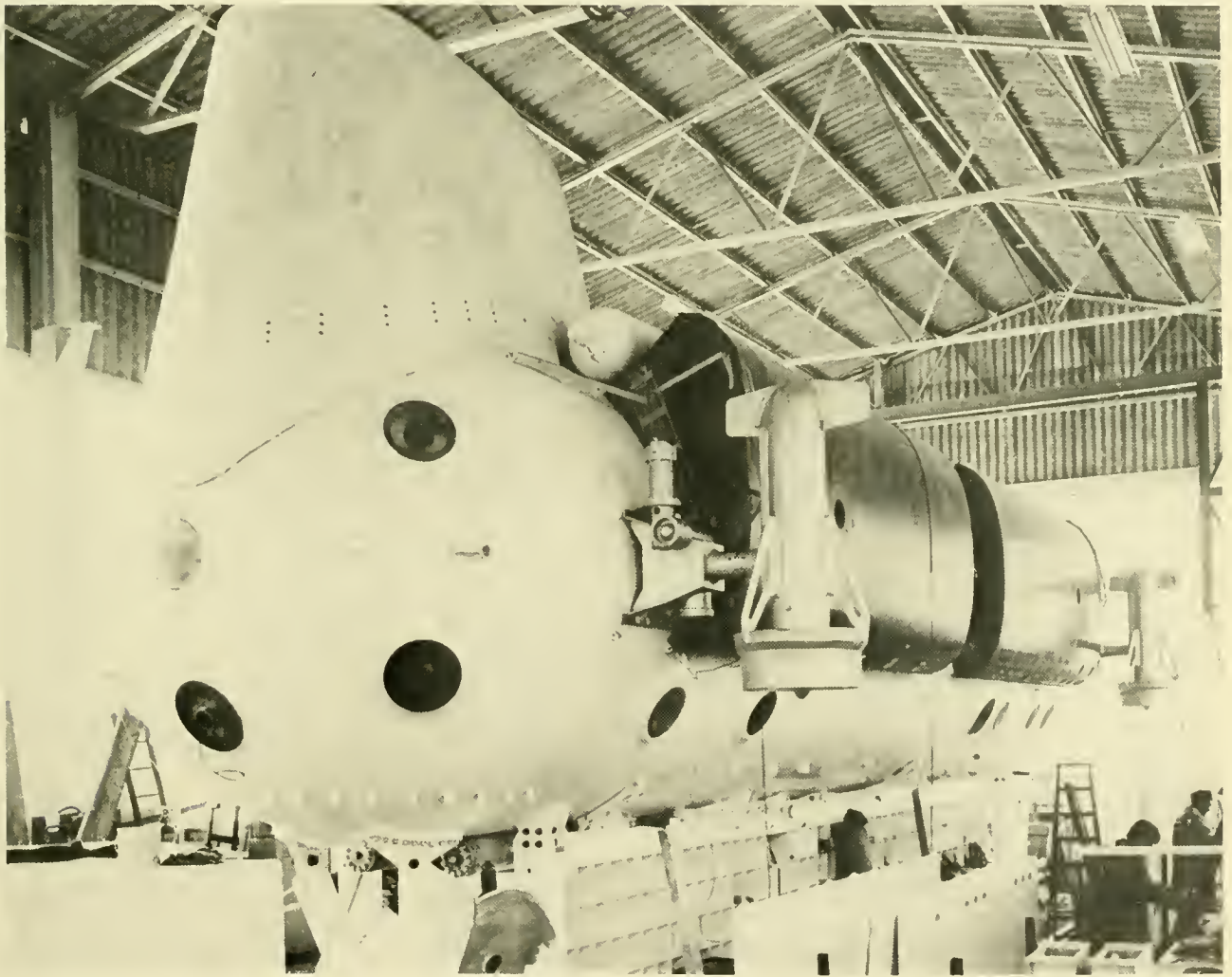

Fig 62 Main ballast tanks of *BEN FRANKLIN* straddle its pressure hull. Cylinder between sail and MBT holds compressed air to blow water ballast (Grumman Aerospace Corp.)

the MBT. Passing through a hull valve each line runs through a check valve, a pressure-restricting diaphragm and into a blow valve aft and just below the vent valves.

b) The *All Ocean Industries* submersible employs compressed air to blow the MBT's, but in a manner distinctly different from *BEN FRANKLIN's* and apparently from all other vehicles. It operates in the following manner: Two MBT's vent directly into the pressure hull; to dive, the operator opens a vent valve which allows water into the tanks and forces entrapped air from the tanks into the pressure hull. Because pressure will build up in the hull, a second valve, called a snorkel valve, is opened to allow the escape of air outside the hull. When a little water appears at the vent valve, it is secured, as are three flood valves leading to the MBT's. The snorkel valve is also closed after the MBT and flood valves are secured. With the MBT's full, the vehicle is still slightly positive and VBT's must be flooded to attain negative buoyancy. To blow the MBT's on the surface, the two MBT flood valves are opened and air from one of two scuba tanks outside the hull is introduced into the MBT. When bubbles can be observed coming out of the MBT's, the tanks are assumed empty, and the hatch (dome) may be opened.

#### **Variable Ballast Tanks:**

**Function:** To provide small scale buoyancy adjustments.

**Operation:** Two approaches are used to attain variable ballasting systems. In the most generally used approach there is a hard tank into which seawater is introduced by means of the ambient pressure differential to attain negative buoyancy and then expelled by either compressed air or a pump to attain positive buoyancy. In the second case, generally on the deep vehicles, a system is used which employs a pressure-resistant tank connected to collapsible (flexible) oil-filled bags. When surfaced, the spheres are partially filled with oil and air at atmospheric pressure; the bags are fully collapsed. To gain positive buoyancy when submerged, the oil is pumped into the bags which expand and displace seawater, thus, providing positive buoyancy. To gain negative buoyancy, the oil

is permitted to flow back into the rigid tank. More accurately, this hard/soft tank system is termed a variable displacement system since the vehicle weight remains constant. Evident from Table 6.6 is the absence of air-blown VBT's below 2,500 feet for reasons given earlier. When hard tanks and water are employed as the variable ballast system on present submersibles, high pressure pumps are used to expel water from the tanks below 5,000 feet.

**Location on Vehicle:** As is evident from Table 6.6, there is no standard location for variable ballast systems. In some vehicles the systems are in the pressure hull (this arrangement saves the expense accompanying a system exposed to seawater and ambient pressure), and in others the system is external to the pressure hull, thereby saving limited internal space in the pressure hull. Those vehicles using variable displacement (hard and soft tanks) systems must locate at least the soft part of the system external to the hull. As a general rule, most VBT's are situated below the vehicle's center of gravity to keep the center of gravity low. This is the case with *AUGUSTE PICCARD* and *BEN FRANKLIN*, where the VBT's are in the vessels' keels. When two or more tanks are used, they are balanced port and starboard or fore and aft; in the latter situation the system may also serve as a trim system by differentially filling the tanks.

**Configuration:** Systems external to the pressure hull employing only air and hard tanks have no particular geometrical configuration on the shallow submersibles, but are generally spheres or cylinders on the deep vehicles. Where the tank is external to the pressure hull it must withstand the same forces as the pressure hull. Because the tank may be pressurized above ambient during ascent, tensile stress is a factor. Where the VBT is within the hull at atmospheric pressure, tensile stresses are the overriding consideration.

Soft/hard tank systems are required to withstand ambient pressures and for this reason the hard tank component is always spherical. Being either pressure-compensated or collapsed, the soft tank component can be any shape.

TABLE 6.6 VARIABLE BALLAST SYSTEMS CHARACTERISTICS

Submersible	Fill/Empty Procedure		Air Blow	Total Capacity (lbs)	System		Location on Submersible <sup>1</sup>	Quantity		
	Pump				Soft/Hard Tanks	Hard Tanks Only		Hard Tanks	Soft Tanks	
	Out	In								
PC3-X			•	320			•	F/A (ex.)	2	
STAR I			•	NA			•	(in)	1	
SUBMANAUT (Helle)	•		•	110			•	(in)	1	
K-250	•			NA			•	NA	1	
SPORTSMAN <sup>2</sup>			•	NA			•	(in)	1	
SUBMARAY			•	68			•	(in)	1	
PC-3A 1&2			•	320			•	F/A (ex.)	2	
KUMUKAHI	•	•		93			•	(in)	1	
SUBMANAUT (Martine)	•		•	4280			•	(in) and Keel	6	
TECHOIVER			•	400			•	F/A (ex.)	2	
ASHERAH			•	340			•	(ex.)	1	
BENTHOS V			•	NA			•	(in)	2	
MAKAKAI	•	•		400			•	each corner	4	
KUROSHIO II			•	888			•	F/A (in)	2	
SURV			•	80			•	Aft (ex.)	2	
SHELF DIVER	•	•		780			•	F/A (ex)	2	
MERMAID <sup>2</sup>			•	NA			•	(in)	2	
HAKUYO				NA			•	(in)	2	
NEKTON <sup>2</sup>			•	30			•	(in)	1	
SEA-RAY			•	NA			•	F/A (ex.)	2	
SEA LINK			•	170			•	P/S (ex.)	2	
STAR II			•	130			•	(ex.)	1	
VOL-L1	•			715			•	F/A (in)	2	
PC5C			•	120			•	P/S (ex.)	2	
SURVEY SUB I			•	440			•	F/A (in)	2	
DEEP DIVER	•		•(aft)	731			•	F/A (in)	6	2
SP-350	•			96			•	(in)	1	
SEA OTTER			•	125			•	(ex.) Fore	2	
SP-500	•			44			•	(in)	1	
SHINKAI			•	660			•	(ex.) amidship	1	
ARGYRONETE				2620			•	F/A	2/2	
BEN FRANKLIN			•	6800			•	P/S (ex.)	1/1	
BEAVER			•	1474			•	P/S/Aft (ex.)	1/1/1	
PISCES <sup>2</sup>	•			300	•			Aft (ex.)	1	2
DS-2000	•			300			•	P/S (ex.)	2/2	
STAR III			•	270			•	(ex.)	1	
AUGUSTE PICCARD			•	4315			•	(in) (ex.)	2/1	
DSRV-1&2	•			1060			•	F/A	1/1	
DS-4000	•	•		NA	•			P/S	2	1
TURTLE	•	•		600	•			P/S	6	2
SEA CLIFF	•	•		600	•			P/S	6	2
DOWB	•	•		512	•			F/A (ex.)	2	2
DEEP QUEST	•	•		1828			•	P/S (ex.)	2	
ALVIN	•			600	•			(ex.)	6	2
DS-20000	•		•(He)	NA	•			NA	NA	NA

<sup>1</sup>F/A = Fore/Aft; (in) = inside pressure hull; (ex.) = external to pressure hull; P/S = port/starboard

<sup>2</sup>All classes of the submersible.

**Materials:** Hard tank systems employ the same material for the VBT as they do for the hull, though in some cases a stainless steel is used. Soft/hard tank systems vary in the nature of the material used for the hard component. *ALVIN*, *SEA CLIFF* and *TURTLE* use titanium spheres, while *PISCES IV* and *V* use HY-100 steel, the same material as found in the pressure hull. The flexible bags in the hard/soft tank system of *TURTLE* and *SEA CLIFF* are composed of reinforced rubber.

**Example:**

(a) The variable ballast system of *MAKAKAI* provides not only positive and negative buoyancy changes, but changes in trim and roll (or heel) as well. From reference (4), ballast tanks are mounted on each corner of the vehicle (Fig. 6.3), and each tank has a capacity of 199 pounds of seawater. Two ballast pumps (one supplying each side) Two ballast pumps (one supplying each side)

pump water in or out of the tanks to provide buoyancy changes. The non-water volume of the ballast tanks is pressure-compensated to 10 to 20 psi above ambient by air stored in four high pressure cylinders (thereby negating the need for pressure-resistant VBT's). The high pressure air is reduced to ambient pressure by a differential pressure-regulating system, and the ballast tanks are provided with relief valves to vent air on ascent. To attain fore or aft trim, water may be pumped fore or aft between tanks, and taken onboard on one side of the vehicle and overboarded on the other side to attain roll angles.

(b) Although now converted to a hard tank system, *ALVIN's* original variable displacement system was typical of other vehicles and worked in the following manner (5). Two large, flexible oil-tight bags were designed to fit into floodable fiberglass com-

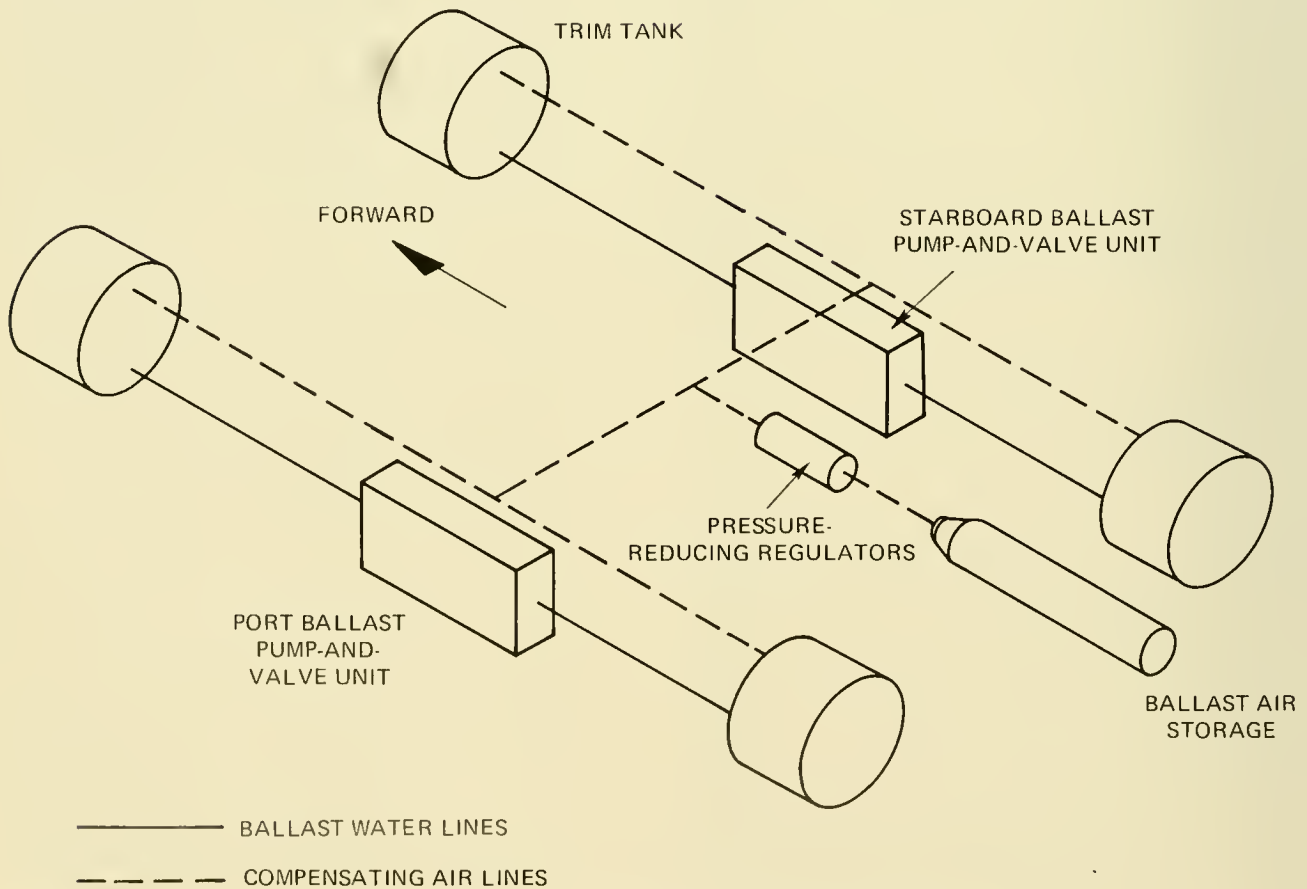

Fig. 6.3 MAKAKAI's ballast control schematic. (From Ref. (4))

partments and six pressure-resistant aluminum spheres were located in the center portion of the vehicle. A high-pressure gear pump pumped automatic transmission fluid from the spheres to the flexible containers (Fig. 6.4). Air at atmospheric pressure filled the spheres when emptied of working fluid. Since the flexible containers were exposed to sea pressure, the pump had to move the

working fluid against sea pressure. A reversible DC motor provided power for the pump. To control the system, a positive-seating (leak-free) ball valve was incorporated into the circuit. The ball valve was opened and closed by a suitable gear train and electric motor. The two motors were under the direct control of the pilot who could control the buoyancy of the vehicle from a heavy condi-

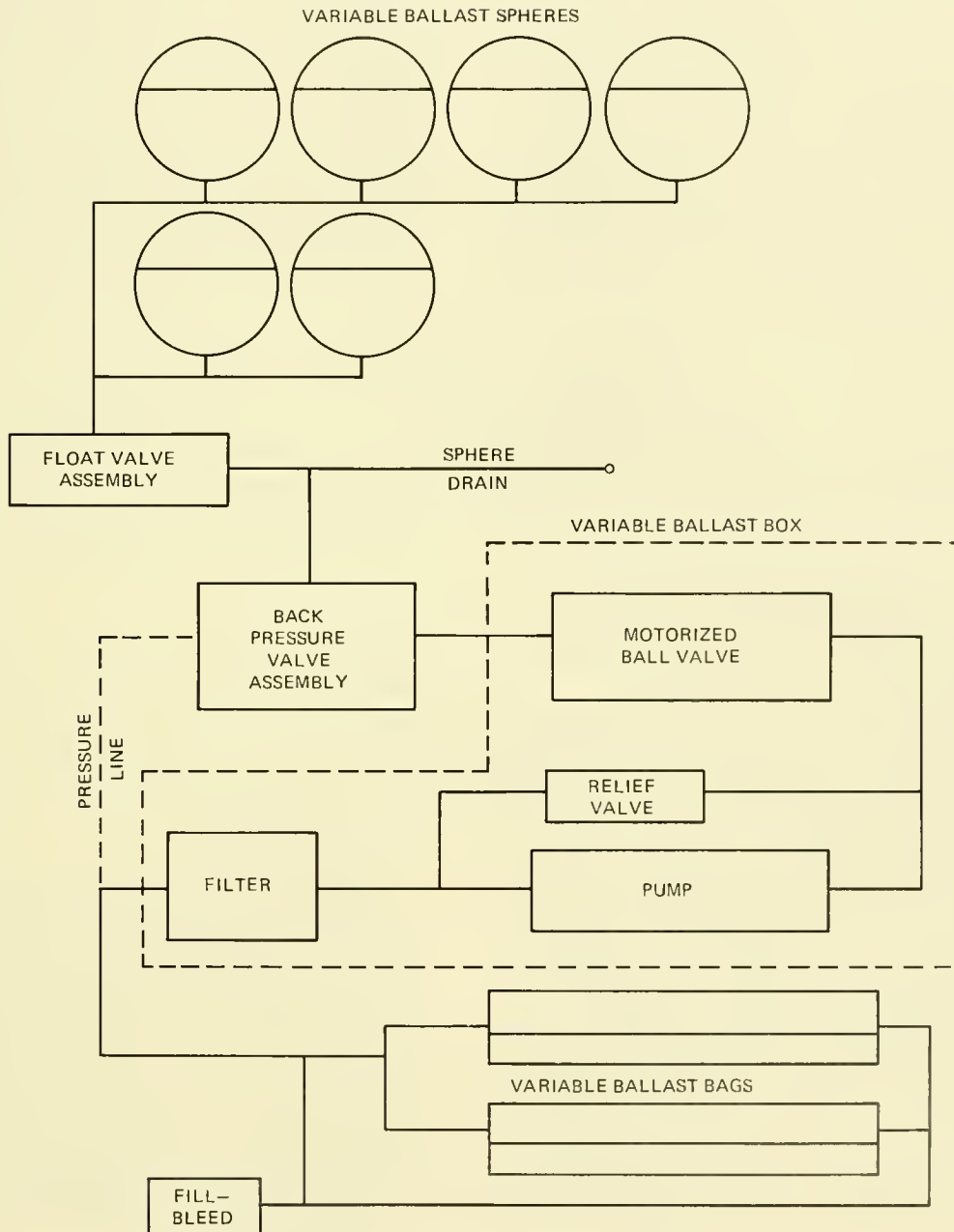

Fig. 6.4 ALVIN's variable-ballast system diagram. [From Ref. (5)]

tion of 600 pounds to a light condition of 600 pounds. A float switch was included to open the electric motor circuit when the working fluid was exhausted from the spheres. A pressure transducer sensed absolute pressure in the spheres. The readout from this pressure was calibrated to show the quantity of oil in the spheres. Relief valves were included to protect the pump motor in case of valve failure and a filter was provided to capture any stray particles in the fluid. Fluid was filtered whenever it was allowed to flow back into the sphere. A check valve system was employed to bypass the filter in the reverse direction.

**DEEPSTAR 4000** used its variable displacement system in a somewhat different fashion than the designers intended when the need for more rapid buoyancy changes arose. In conjunction with its small weight drop system (described below) the system worked as follows: At neutral buoyancy, the flexible bag was full; if positive buoyancy was needed, a 3.4-pound weight was dropped; if negative buoyancy was necessary, fluid was pumped from the flexible bag. Hence, a round trip from negative-to-positive-to-negative was reduced by half that required if the total variable displacement system was employed.

#### **Ascent/Descent Weights:**

**Function:** To assist the submersible in descending and ascending to and from the bottom while conserving electrical power.

**Operation:** Generally one weight is hung fore and another aft; both are attached prior to launching. When the MBT's and VBT's are full, the vehicle descends to some depth short of the bottom, and the descent weight is dropped to give the vehicle approximate neutral buoyancy. At dive termination, the ascent weight is dropped allowing the vehicle to surface. On some vehicles, e.g., **ALVIN**, a descent weight only is used to hasten the initial descent and, at the same time, conserve electrical power which might otherwise be required to run the vertical thrusters during descent.

**Location on Vehicle:** On the French vehicles **SP-350** and **SP-3000** and on **DS-4000**, the descent weight is on the stern centerline and the ascent is forward on the brow.

**Configuration:** Any compatible to the vehicle.

**Material:** Lead or cast iron.

#### **Example:**

(a) **DEEPSTAR 4000** dives with 220-pound cast iron descent weight aft which causes the vehicle to descend bow high. At some predetermined depth, the descent weight is hydraulically jettisoned, and the vehicle comes to the near-horizontal position. At dive termination, a 187-pound ascent weight mounted forward is dropped, and **DEEPSTAR 4000** ascends (Fig. 6.5). A negative feature of this system lies in the fact that once the ascent weight is dropped, the vehicle cannot descend again without additional negative buoyancy. In the event of the submersible ascending into an overhanging cliff or obstruction, it would be unable to descend again without external assistance.

(b) **DEEPSTAR 4000's** sister submersible **DS-2000** combines both a descent weight and a hard tank. The descent weight performs the same function as in **DS-4000**, but instead of an ascent weight, a 120-pound-capacity tank (which is flooded at the start of the dive) has been substituted. When the dive is terminated, the seawater is blown from the hard tank and the vehicle rises. This allows an increase of 120 pounds in payload owing to the absence of the ascent weight.

#### **Anchor:**

**Function:** To provide static stability while working on the bottom or hovering. It also may serve as a keedge to assist in pulling large devices on the bottom.

**Operation:** A hydraulically driven winch, cable, and anchor can be employed by the operator as desired.

#### **Example:**

Two submersibles routinely carrying anchoring devices are **BEAVER** and **NEMO**. While both vehicles are quite different, their anchoring systems are essentially similar. Hence, **NEMO** will serve as an example of both and its description is taken from reference (6).

**NEMO's** primary vertical mobility and station-keeping modes are provided by the winch/motor system housed in the main ballast tank. The winch drive motor is a Vickers fixed-displacement, reversible hydraulic mo-

tor and is located in a housing directly beneath the bottom plate of the pressure hull, with pressure compensation being provided by reference to the hydraulic distribution housing. The winch motor drives a drum which holds 1,200 feet of 1/4-inch non-rotating wire rope. The winch features a barrel gear level wind assembly and cable guide to assure proper cable laying. The guide also houses a hydraulic cable cutter, pyrotechnic cable cutter and an interlock sensing assembly to override the winch control. This interlock arrangement automatically slows and stops the winch as the anchor approaches *NEMO*.

Winch operations are controlled by four switches on a control console. The winch motor switch and the winch jog switch supply power to the winch speed and direction switches, which in turn actuate hydraulic

solenoid valves. The winch motor switch is used for continuous operation, and the jog switch is used for momentary operation. If the hydraulic generator is on and either the jog or the run switch is actuated, the winch will start operating in the direction selected by the direction switch ("reel in" or "reel out") and at the speed selected on the speed switch ("fast" or "slow"). The winch lock switch actuates a solenoid valve which provides a hydraulic lock on the winch motor. This lock is automatically overridden when either the run or jog switch is used. In addition, the winch has four ways in which it may be free-wheeled. To reset the interlock system (which automatically slows and then stops the incoming anchor before it reaches the winch), the jog switch is operated twice. A 25-in.<sup>3</sup> accumulator is incorporated in the winch motor hydraulic loop to cushion sud-

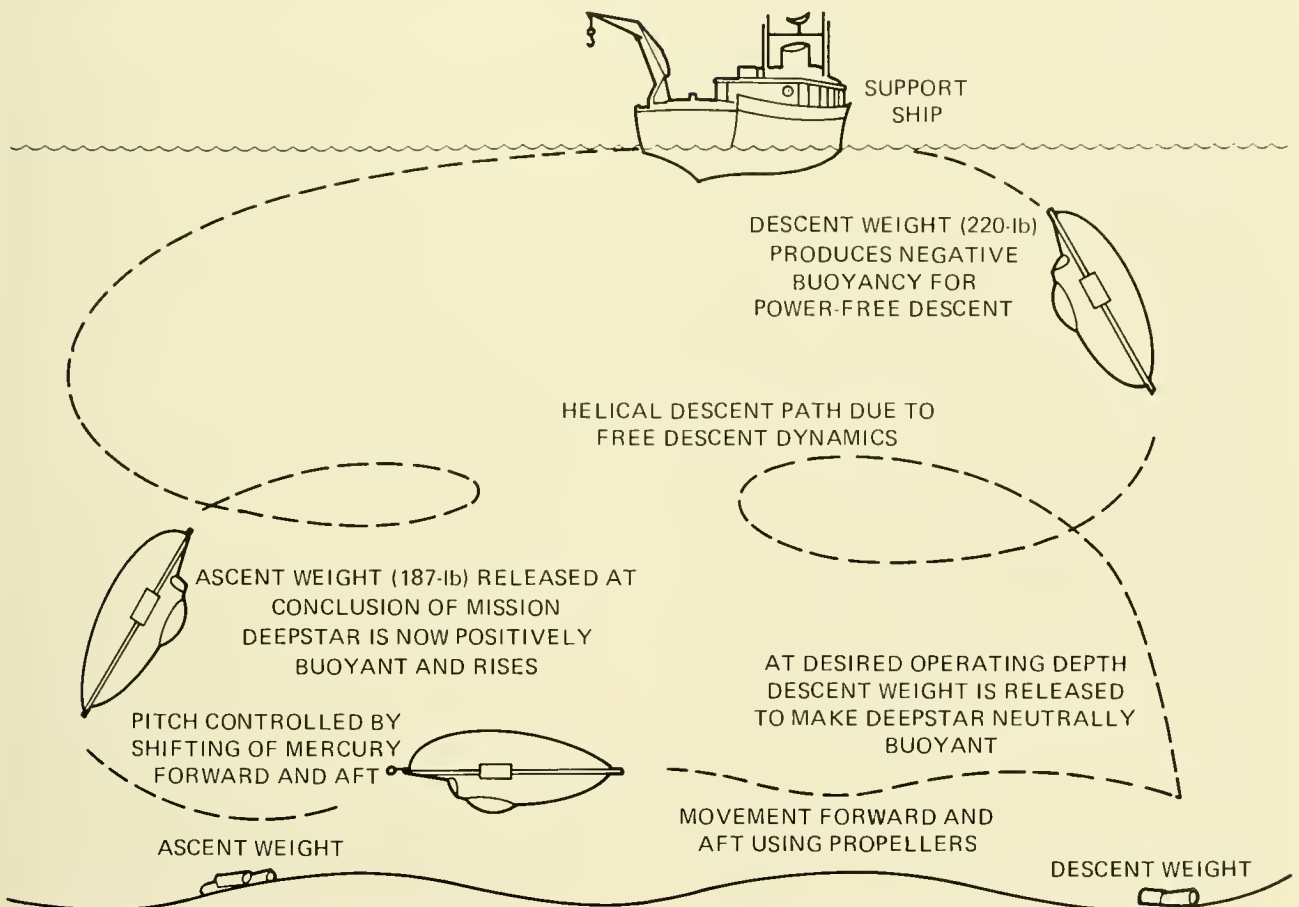

Fig. 6.5 DEEPSTAR 4000's descent/ascent weight system.

den anchor stops. Although a variety of anchors may be used, a 380-pound clump was employed. A manually operated hydraulic system located inside the pressure hull serves as a means of cutting the anchor cable and controlling the mechanical winch brake.

#### **Cables:**

**Function:** To provide a means of maintaining constant altitude within range of bottom viewing.

**Operation:** Consists merely of a cable (wire rope or chain) of desired length and weight which is attached to the vehicle on or near the keel. During descent, the submersible slowly nears the bottom with the cable arriving first and accumulating there until its weight loss puts the vehicle at neutral buoyancy. At this point, the vehicle is essentially anchored in the vertical, but is free to move in the horizontal.

#### **Example:**

All of the bathyscaphs employed a cable for altitude control at one time or another. The only submersible to extensively use such a device was *BEN FRANKLIN* on its 30-day drift in the Gulf Stream. This system is described below.

A 40-foot-long 100-pound chain, housed in a flexible polyvinyl chloride (PVC) hose, was attached to *BEN FRANKLIN*'s stern. A weak link stood between the chain and vessel which would break before the vehicle reached its capacity to attain full positive buoyancy in the event of the chain fouling.

In operation, the submersible bottomed and then blew its VBT's enough to ascend slightly to a point some 20 feet off of the bottom where the chain restrained it. The current then caused the vehicle to move and drag the chain behind. With the chain at the stern providing drag, the submersible was oriented with its bow pointed downstream and it proceeded along as if under power. When a mound or other minor relief feature was encountered, the excess chain accumulating on the feature decreased the vehicle's weight and it ascended accordingly; in the event of a depression, the excess chain hanging suspended caused the vehicle to descend. While there are drawbacks to this method of buoyancy control, for near-bottom cruising

at a specific altitude and over relatively smooth terrain, the system is virtually unbeatable. According to the elder Piccard in *In Balloon and Bathyscaph*, this technique was first used by the balloonist for cruising at low altitudes over land.

## **Irreversible Systems**

#### **Pressure Hulls:**

In most submersibles (excluding the bathyscaphs) the pressure hull exerts a positively buoyant force, the extent of which depends on the W/D ratio. This force is not constant at all depths owing to the compressibility of the hull which reduces its displacement. The *SP-3000*, for example, carries two jettisonable 33-pound weights which are released to compensate for loss of positive buoyancy through hull shrinkage. The bathyscaphs are a different situation wherein the pressure hull is negatively buoyant and the problem is one of getting it to ascend rather than descend.

#### **Syntactic Foam:**

For great depths syntactic foam is one of the most promising positive buoyancy materials. The foam consists of a mixture of hollow microspheres embedded in a resin matrix. Some foams use plastic or glass microspheres, and matrix materials of polyesters, phenolics, polyethylenes or vinyls (7). Several factors make syntactic foam an attractive buoyancy material:

- Low density

- High hydrostatic strength

- Low water absorption

- Immunity to catastrophic failure

- Bulk modulus equal to or slightly higher than seawater

- Fabricability to irregular shapes by casting or machining

One of its greatest features is the relative ease with which it can be machined or cast to fill small, large, and irregularly shaped voids within the exostructure. In some cases, it is merely attached as blocks to the vehicle or strapped into an existing cavity to provide greater payload for a specific dive. At times, syntactic foam performs more than one function. Figure 6.6 demonstrates its uniqueness by serving both as positive buoyancy material and a stabilizing rudder on *TURTLE*.



Considerable effort is being expended by both government and industry to decrease the foam's density and, correspondingly, its cost. Present efforts at NSRDC are aimed at developing a 34-pcf syntactic foam for depths of 20,000 feet (8). Both the *DSRV's* and *DEEP QUEST* employ syntactic foam of 36-pcf using glass microspheres. Standard 42- to 44-pound foams cost in the neighborhood of \$10 to \$15/pound; 34-pound foam is projected to be some \$40/pound in orders of 40,000 pounds. An indication of the expense involved is gained by considering that *DS-20000* would carry some 13,060 pounds of 42-pound syntactic foam.

According to Rosenberg (7) a 30-pound foam for 20,000 feet should be possible, but considerable development in the glass mi-

crossphere system is required before this goal can be realized. Owing to its wide application by the marine community—not only in submersibles but in salvage and other areas as well—syntactic foam appears as promising today as did acrylic plastic in its infancy.

#### Hard Tanks:

Six submersibles can be identified that use pressure-resistant tanks as a means of attaining positive or negative buoyancy. Three of these (*SP-3000*, *DEEP JEEP*, *DS-2000*) use pressure-resistant tanks as a component of a variable ballast system whereby the tank is either blown or flooded and played against an opposing system, such as a small weight drop.

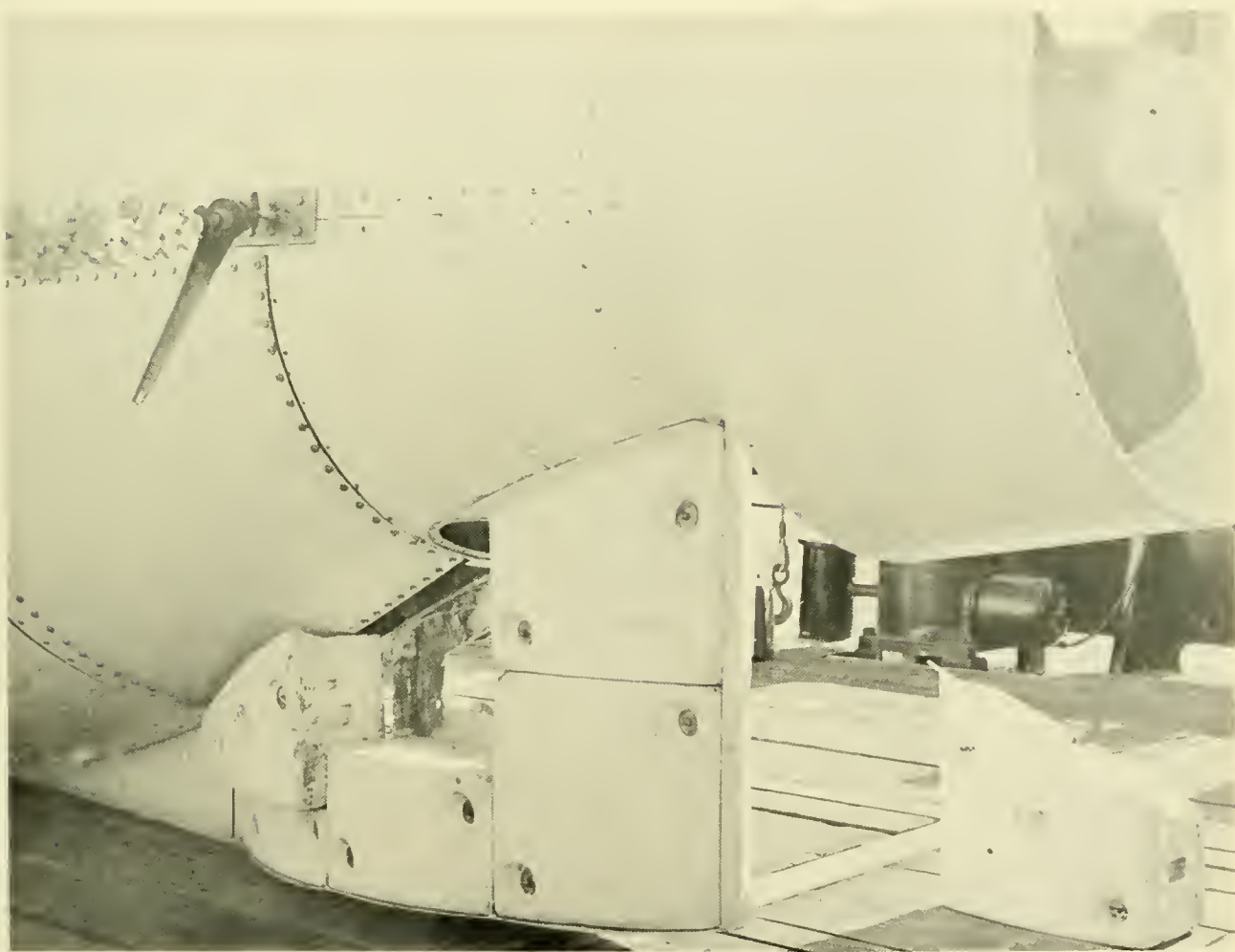

Fig 6.6 Syntactic Foam blocks cut to serve for stabilization and positive buoyancy on *TURTLE*.

In the *DSRV's* two 5,564-pound-capacity tanks are used to store water that is pumped out of the mating skirt after it has attached to a stricken submarine; in effect, these tanks work as both positive and negative buoyancy systems although their functioning is strictly a by-product of the rescue mission.

*ALVIN*, in its early design, incorporated nine aluminum (7178-T6) spheres within a syntactic foam (42 pcf) package to provide approximately 4,000 pounds of positive buoyancy (Fig. 6.7). To prevent corrosion and stress corrosion, oil surrounded each sphere. The spheres were later discarded and now the entire package consists solely of syntactic foam.

#### **Collapsible Bags:**

Carried within each sphere of the *DSRV*

are four collapsible bags. Prior to a rescue dive, the bags are filled with water to provide 4,080 pounds of negative buoyancy. When the rescues are aboard the *DSRV*, the bags are drained into the stricken submarine to compensate for the weight of the rescues.

#### **Small Weight Drop:**

A system common to all French and Westinghouse vehicles involves the dropping of small lead weights to incrementally attain positive buoyancy; *DEEPSTAR 4000* may serve as an example. Located immediately aft of the pressure sphere 3.4-pound lead weights hang on a notched track trending port-starboard. When the pilot activates the command lever, hydraulic pressure shifts a double-ended piston to one side and ratchet fingers attached to a sliding carriage engage



Fig 6.7 *ALVIN's* original buoyancy package consisted of syntactic foam and aluminum spheres. The total package provided 4,000-lb positive buoyancy (WHOI)

one of the rachets, moving it inboard  $\frac{5}{16}$  of an inch. This movement removes the support for a weight and the weight falls free of the housing. The next time hydraulic pressure is applied, the piston and carriage move in the opposite direction. A ratchet finger engages the other ratchet bar and a weight is dropped as the bar moves inboard.

**DEEP JEEP** incorporated the same principle with thirty 4-pound steel plates surrounding its battery pod; in this case, each plate was held in place by an electromagnet which, when power ceased, dropped the weight. In the event of a total power failure all weights were automatically jettisoned.

### Iron Shot:

Adopted from the **FNRS-2**, the dropping of iron shot to attain positive buoyancy has been incorporated into several contemporary submersibles and was used on all the bathyscaphs (Table 6.5). The type of shot used resembles "BB's" and the only hard requirement is that the shot have magnetic properties. The younger Piccard, in **Seven Miles Down**, related the difficulty in attaining shot with sufficient residual magnetism in the U.S., thus necessitating ordering shot from Italy to accomplish **TRIESTE's** early mission leading to the deep dive.

In concert with the host of dissimilar procedures to accomplish similar functions from submersible-to-submersible, no two shot systems are identical in location of shot tanks or method of shot control, though all use "fail-safe" electromagnets to hold in the shot. **BEN FRANKLIN** is one example of this method of attaining positive buoyancy.

The shot ballast system of **BEN FRANKLIN** has two functions—to adjust the buoyancy of the boat by metering out shot through a specially designed electromagnetic valve, and to provide 6 tons of buoyancy (6,372 pounds per tank) in an emergency by rapidly dropping all of the shot (release of hydraulic pressure on a piston opens a large door at the bottom of the shot ballast tank).

Separating the two main ballast tanks port and starboard, the shot ballast tanks are filled with iron shot (Globe Steel S-780C) up to a point about 4 inches below the waterline. The tanks are free-flooding and are always open to the sea in order to pressure compen-

sate the tanks and to prevent rusting of the shot into an unmanageable agglomeration. When completely immersed in seawater, the corrosive action on the shot is minimized and the granules remain free.

Each shot ballast tank is fixed to the sides of the hull by attachments similar to those on the main ballast tanks but with elongated bolt holes designed to allow for any play which occurs during expansion or compression of the pressure hull. The tanks are constructed of sheet steel supported internally by steel truss frames.

The shot dropping systems consist of two electromagnetic valves—one for each shot tank. Each valve has two sets of coils—110 VDC and 28 VDC. The 110-volt holding coils are made up of soft iron cores which can be permanently magnetized by coils when supplied by 110 volts. These "magnetic valves" are used to hold the soft iron shot in the ballast tanks when permanently magnetized and the power is removed. This is accomplished when the shot ballast becomes magnetized in the "throat" of the valve. The valve can be demagnetized to release its hold on the shot by cycling the 110-VDC voltage through progressing voltage dropping resistors. Dropping the voltage and cycling both the plus and minus values through the coils, the cores become totally demagnetized since any residual magnetic effects are erased in this manner.

The 28-volt metering coils are essentially electromagnets which are used to control the flow of the soft iron shot through the valves. This is accomplished when the 110-volt coils are demagnetized and the 28-volt coils are de-energized. Flow of shot is stopped when the full 28 volts are used to energize the electromagnet and the soft iron shot in the valve's throat is magnetized. This condition can be maintained when the voltage is reduced to 14 volts.

The electric metering system, used to measure the amount of shot in each of the two tanks, consists of a transformer vertically oriented in each tank. The primary coils are excited by 20 VAC which has been stepped down via a transformer from the 110-VAC bus. The secondaries of the metering transformer are returned into the boat and terminated into voltmeters. The voltage

recorded on the meter is directly proportional to the amount of shot in the tank, since the level of shot represents the amount of mutual coupling between the two coils and, hence, the induced voltage on the secondary.

A specially constructed timer is installed in the pilot's console and consists of two stop watches each connected to one of the shot ballast circuits. The timer automatically starts and stops as shot ballast is metered out of each hopper. The quantity of shot jettisoned by the operator is simply calculated by time units as 4.4 pounds of shot fall through the valve per second.

An emergency shot ballast system was installed to provide a quick release of ballast in case of flooding or some other emergency requiring rapid surfacing or extra buoyancy. Hydraulic pressure (140 kg/cm<sup>2</sup>) is built up in an accumulator which in turn holds a port and starboard hydraulic piston in a position that prevents a trap door at the bottom of each tank from opening. By opening a valve that allows the hydraulic fluid to return to the reservoir, hydraulic pressure is released on the piston which in turn allows the trap door to open. (The weight of the shot causes the piston to move to the opposite end of the cylinder when hydraulic pressure is released.) The trap door, hinged on the opposite side, allows the shot to drop rapidly. If a piston fails to move due to corrosion or some other reason, hydraulic fluid can be forced to the opposite side of the piston to provide an additional force. By operating valves in rapid succession, the entire operation, including power to the opposite side of the piston, is accomplished very quickly.

Seals at each end of the piston prevent seawater from entering the cylinder. Around the rod is fitted a stainless steel cylinder or sleeve capped with a rubber boot. The cylinder is packed solid with grease and the boot can move in and out slightly with sea pressure. This end of the piston is untouched by seawater and cannot corrode.

If the boat has been towed or in port for several days just prior to diving, the trap door/piston mechanism is tested by having a diver install a special screw fitting in each tank that holds the trap door in place. The piston is then moved by applying power in

the opposite side of the cylinder and a diver can observe whether or not the piston retracts.

The logistics involved with steel shot ballast can be somewhat restrictive on open-sea operations. Because the majority of submersibles using this method are too large to be launched and retrieved for each dive, they must be replenished while in the water. Generally, this is accomplished in a harbor or protected area (Fig. 6.8) where the sea state is not a problem; however, on occasion it is necessary to transfer shot at sea. When this is the case, it can be quite difficult transferring several thousand pounds of shot in 25-pound bags from the support ship to the vehicle.

### **Gasoline:**

The positive buoyant force on all bathyscaphs is derived from gasoline contained in a metallic float. Several factors enter into the selection of petroleum hydrocarbons for deep-water buoyancy applications:

- Gasoline is readily available and at relatively low cost.
- Although not as effective as air at shallow depths, gasoline retains most of its buoyancy at any depth.
- Petroleum hydrocarbons can reach a density of 0.66 gm/cm<sup>3</sup>, which is good relative to seawater (1.025 gm/cm<sup>3</sup>).

On the other hand, there are several disadvantages, the main one being flammability. Unfortunately, the hydrocarbons with the lowest density are the most flammable; for this reason, kerosene, in spite of its high density, is often used.

The logistic and safety problems involved with gasoline flotation are quite complex. The U.S. Navy's *TRIESTE II* carries 75,000 gallons of aviation gasoline (0.76 gm/cm<sup>3</sup>) in its float. The bathyscaph is first launched from its support ship and then filled with gasoline when clear, the entire process accounting for some 15 to 20 hours. To return to its support ship, the float is pumped dry of almost all gasoline and the pressure in the float is maintained by introducing gaseous nitrogen, which also serves to purge the float of fumes. When *TRIESTE II* is within its support ship (*ARD*) the additional 1,000 to 2,000 gallons of gasoline remaining in the

float is drained through valves at the float bottom. The recovery procedure takes about the same time as launching. Some 300,000 gallons of gasoline are carried aboard the *ARD*, and at 19¢/gallon, the cost is not insignificant. Some savings are realized, however, because the unused gasoline can be turned back in and used for its original purpose.

Controlling buoyancy when using gasoline is a fulltime job. As the bathyscaph descends, the gasoline loses some buoyancy because it is more compressible than seawater and the ambient temperature causes it to cool. Consequently, the operator is required to drop shot ballast to compensate for the loss of positive buoyancy. On ascent, the reverse occurs and the operator is required to vent off gasoline to maintain a steady,

controllable rate of ascent. Piccard (9) described in detail the complications involved with gasoline as a buoyant source. The conclusion is easily reached that syntactic foam, in spite of its present high cost, is an ideal replacement for gasoline.

## TRIM SYSTEMS

The ability to change a submersible's up or down bow angle solves two general operational problems: 1) Instruments or equipment may be installed that cause the vehicle to be heavy in the bow or stern; this can be corrected by adding or subtracting weight or displacement at the opposite end, and 2) if a submersible is required to follow an upward or downward sloping bottom, its bow angle may be changed statically so that the vehicle "flies" parallel to the bottom. More special-



Fig 6.8 ALUMINAUT's crew loading shot ballast at Roosevelt Roads, Puerto Rico. (NAVOCEANO)

ized use of a trim (and roll) capability is found with the *DSRV*'s where a stricken submarine may lay on the bottom at an angle requiring the *DSRV* to attain both a down angle on the bow and a starboard or port list angle in order to mate with the submarine's escape hatch. A similar case may be made for lock-out submersibles mating with underwater habitats at other than a level attitude.

The methods used to gain trim in submersibles range from very simple to complex but they all involve one of two procedures: 1) The transferring of weight from one part of the vehicle to the other; or 2) the taking aboard or releasing weight at one location on the submersible or another. The transfer of weight, in the case of cylindrical, pressure-hulled vehicles, need be nothing more complicated than a passenger walking fore or aft to produce an angle on the bow. In *ALUMINAUT*, if one of the crew desired to walk fore or aft, while the vehicle was underway, his movement had to be countered with a concurrent movement of another member from the opposite end to take his place. If this procedure was not followed, the vehicle's trim was substantially affected. The spherical-hulled *DS-4000* (BG—3 in.) experienced the same effect if the aft crew member leaned forward to join the operator and scientist at the viewports. The "tenderness" of submersibles toward such trim changes resides in the small longitudinal metacentric height (Table 6.7) which makes the vehicle vulnerable to quite small weight shifts. *BEN FRANKLIN* is an exception to such vulnerability. During the Gulf Stream Drift, the six crew members ran fore and aft together in an attempt to produce instability and could do no more than produce a dive angle of 10 degrees from which the submersible immediately recovered although the crew remained in the bow.

While many submersibles do not have a trim system *per se*, the manual placing of lead or iron weights fore and aft during the dive can, to a degree, produce the desired results. On a mission off Vieques Island, Puerto Rico, in 1968, *ALUMINAUT* was able to parallel a 30-degree sloping bottom by the crew transferring ballast weights from forward to aft. Such procedures are generally

impractical in the single, spherical pressure hulled submersibles as sufficient moment cannot be gained in the small sphere, and payload, which the lead takes up, is at a premium.

Trim systems may be located external to the pressure hull or within it (Table 6.7). Several factors affect the locating decision, the most significant being limited internal volume and effective moment. Submersibles incorporating internal trim systems are those with cylindrical pressure hulls where a large moment arm can be attained and internal volume is available. Systems external to the pressure hull are generally found in spherical-hulled vehicles. The following is a description of each type of trim system from a selected vehicle in the groups shown in Table 6.7.

## Internal Trim Systems

### Water Transfer Systems:

The submersible *BEN FRANKLIN* has one trim tank forward and one tank aft inside the bottom of the end closures at each end of the pressure hull (Fig. 6.9). Each tank has a capacity of 50 ft<sup>3</sup> (3,100 lb of fresh water), and the base of each is formed by the inside contour of the hull. Steel plate sections are welded to form the upper surface of the trim tanks. A vertical wall at the aft end of the forward tank and forward of the aft tank is made of one 3-mm steel plate welded flush to the interior edge of the hull stiffeners; in this wall is an inspection manhole.

Enough water to fill one tank completely is carried during a mission and is sufficient to produce approximately a 10-degree up/down bow angle.

The forward trim tank has a filling hole in the top, closed by a threaded plug. Both tanks are linked by a polyethylene pipe joined to metal tubes located on the top of each trim tank. Each metal tube has a valve for air release.

When water is pumped from either tank it vents through the overhead pipe into the opposite tank, and moves through two polyethylene pipes, running fore and aft down the port side of the boat, which are connected to trim pumps.

The trim pumps—JABSCO Model 10490, ball-bearing, self-priming pumps—are mounted on brackets bolted to blocks welded to the hull. The pumps are turned by electric motors and controlled at the pilot's station. Each pump operates in one direction only.

They are connected to the 110-VDC bus and run at 1,750 rpm (2 hp) with a capacity of 84 gal/min.

The forward trim tank has a manometer connection for reading the percentage of water. The gage is located at the pilot's

TABLE 6.7 SUBMERSIBLE TRIM SYSTEMS

Submersible	Metacentric Height (in.)	Weight Shift (lb)	Bow Angle (± degrees)	Internal		External								
				H <sub>2</sub> O Transfer	Mechanical Weight Shift	Mercury Transfer	VBT Diff. Fill	MBT Diff. Fill	Shot Diff. Fill	Battery Shift	H <sub>2</sub> O Transfer	Oil Transfer		
ALUMINAUT	9.7	300	30	•										
AUGUSTE PICCARD	8.4	4020	NA	•										
BEN FRANKLIN	10.3	3100	10	•										
SHINKAI	7.2			•										
PC-3B				•										
YOMIURI				•										
HAKUYO	6.0		10		•									
PC5C					•									
TOURS 64/66					•									
ALVIN		540	25			•								
DEEP QUEST	3.0	1400	30			•								
DS-2000		1250	30			•								
DS-4000	3.0	225	30			•								
DS-20000		630	30			•								
DSRV-1&2		1428	45			•								
SEA CLIFF/TURTLE	3.6	620	30			•								
SP-350						•								
SP-500						•								
SP-3000						•								
STAR III	2.7	270	15			•								
AQUARIUS I							•							
DEEP DIVER		730					•							
DEEP VIEW	2.4						•							
KUROSHIO II							•							
PAULO I							•							
PC-3A 1&2							•							
MAKAKAI	12.0	400					•							
SHELF DIVER							•							
SURVEY-SUB 1							•							
VOL-L1							•							
BENTHOS V								•						
SEA OTTER								•						
GUPPY									•					
MERMAID			20							•				
NEREID 330		4800	30								•			
PISCES I	3.0		15									•		
SDL-1			30										•	
BEAVER	3.6	1474	27										•	
DDWB	5.0		2.5											•
PISCES II, III, IV, V	3.0													•

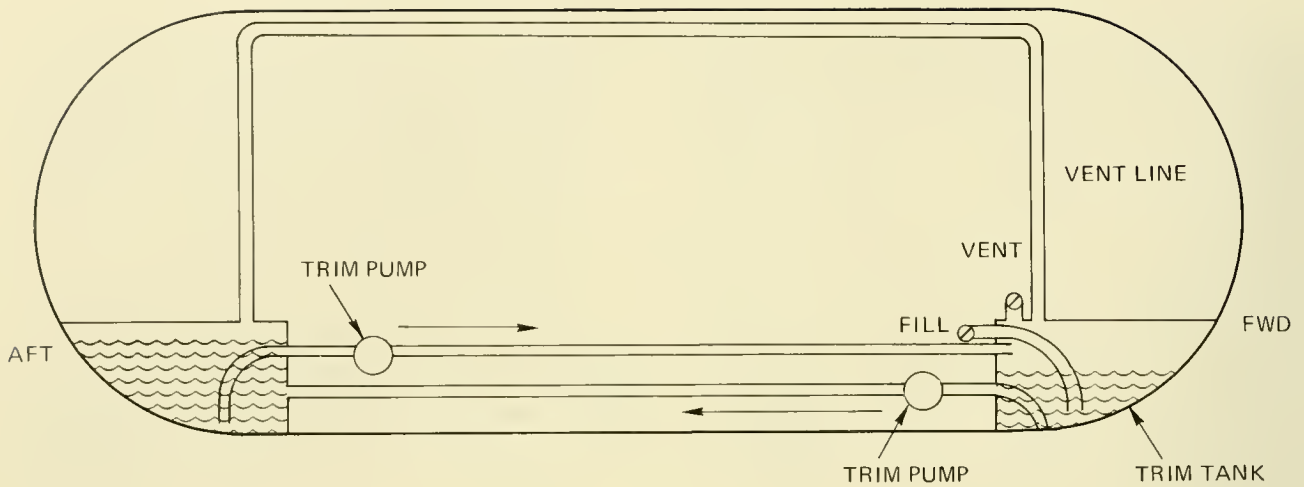

Fig. 6.9 BEN FRANKLIN's trim system.

console and connected by tubing to the tank. A small plunger next to the gage is pulled out to let air into a cylinder. The plunger is then pushed in, forcing air into the manometer and bottom of the trim tank. The amount of back pressure forced into the manometer depends on how deep the water level is in the tank.

#### Mechanical Weight Shift:

The simplest of all trim systems is displayed by submersibles which merely shift a cast iron or lead weight fore and aft inside the pressure hull. The Japanese *HAKUYO* has adopted a lead weight moving system which is described as the simplest, safest and most accurate method of trim control (10). The system (Fig. 6.10) consists of a lead weight moved along a rail by means of a hydraulic motor controlled by solenoid valves. The trim may be changed  $\pm 10$  degrees.

### External Trim Systems

#### Mercury Transfer:

To achieve relatively large trim angles, several vehicles employ a fore and aft weight shift in the form of mercury; *ALVIN* is one. According to Mavor *et al.* (5), available space on *ALVIN* precluded the shifting of items such as batteries for trim purposes, and fluid was required for flexibility in geometric shape. Several fluids were analyzed for their suitability. Some of the less dense fluids

would have added less to the gross weight of the vehicle, but the space problem was so critical that a fluid with a density approaching mercury was required.

Mercury, however, is a difficult fluid to use and has a corrosive effect on many metals. This problem was solved by using a hydrocarbon fluid in the pumping system. The fluid in the system thus became half mercury and half oil. The two fluids were found to separate adequately if a settling stand-pipe was provided for this purpose—oil on top, mercury on the bottom.

The fluid is contained in three small fiberglass spheres, two forward and one aft. An electrically driven pump is utilized to transfer the mercury by displacing the oil in the closed system. Two blocking valves and a reversing valve are incorporated in the circuit to control fluid displacement. The valves are electrically operated by solenoids. The valves and pump motor are wired to a single control for convenient operation. Filters and relief valves are used for system protection in the conventional manner.

Angles of approximately  $\pm 25$  degrees are achieved by transferring 540 pounds of mercury with the system as shown in Figure 6.11.

#### VBT Differential Fill:

The *DEEP DIVER* trim system can change trim or overall buoyancy by using a seawater medium which functions all the way from the



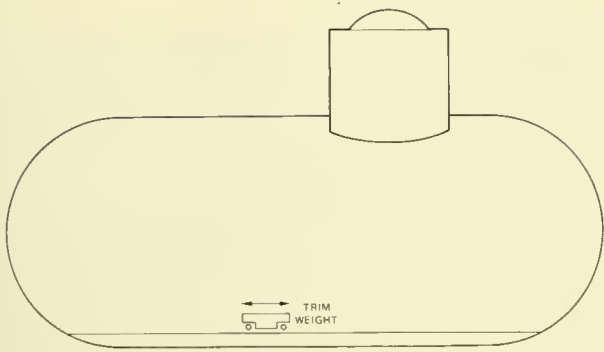

Fig. 6.10 HAKUYO's mechanical weight trim system.

surface to **DEEP DIVER's** maximum operating depth. The system consists of an electric motor, pump, selector valves and fore and aft tanks. It is designed to pump water to or

from the sea as well as transfer water fore and aft.

The trim tank in the pilot's compartment is split into six sections. The diver's compartment trim tank is split into two sections. Under normal submarine operations both fore and aft tanks are used to maintain trim. During lock-out dives the aft trim tank provides negative buoyancy to partially compensate for the weight of the departing divers.

The trim tanks located in the diver's compartment can be flooded through the compartment vent valve or blown dry in 1 minute through the same valve by increasing compartment pressure 5 psi over ambient.

The trim pump is a positive displacement piston type capable of delivering 4 gallons

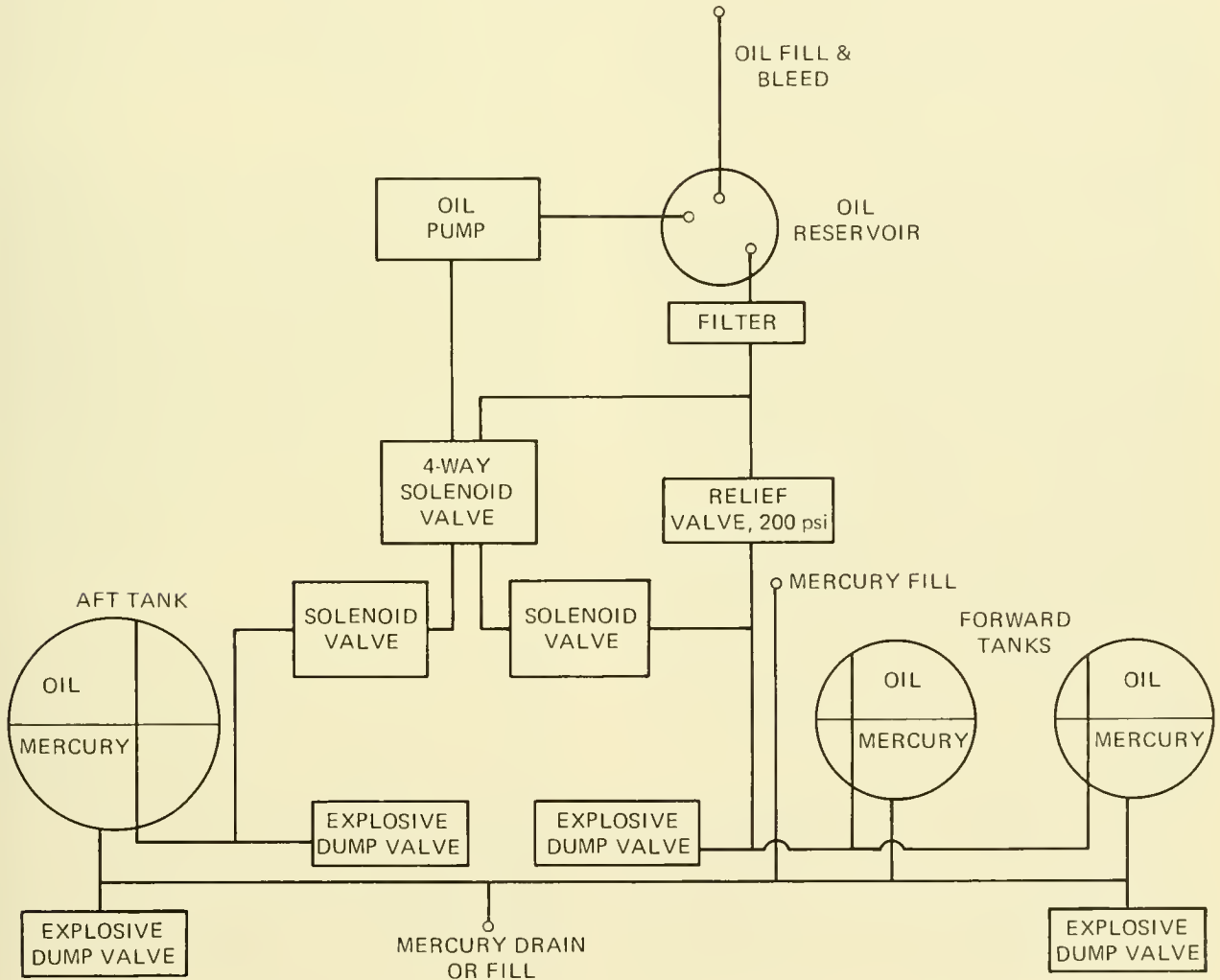

Fig. 6.11 Mercury trim system of ALVIN. [From Ref. (5)]

per minute against a head of 700 psi. A 3-hp, shunt-wound, 120-VDC motor drives the pump.

The trim tanks, constructed to fit the hull's inside contour, have a total capacity of 356 pounds in the forward tanks and 375 pounds in the aft tanks.

The system is designed for working pressure of 700 psi and is protected by the use of a relief valve. A strainer is located at the pump inlet to remove suspended matter from the seawater or the system to protect the pump from damage.

#### **MBT Differential Fill:**

Two vehicles, *SEA OTTER* and *BENTHOS V*, attain trim by differentially filling their MBT's. The system is operationally similar to differential filling of the VBT's as described above. When partially full the MBT's, which are not pressure-resistant tanks, must be pressure compensated; in the case of *SEA OTTER*, internal pressurization is accomplished by high pressure air.

#### **Shot Hopper Differential Fill:**

Vehicles that include fore and aft iron shot containers for jettisonable ballast have the option of differentially dropping shot to attain a variety of up or down bow angles. However, the general operational procedure is to drop shot equally from both hoppers to retain horizontal trim. Only one submersible, the tethered *GUPPY*, operationally employs its droppable shot to attain trim (11).

Shot ballast in *GUPPY* is provided in a single cannister on the fore-and-aft axis of the sphere and forward of the sphere center. Shot can be released from inside the sphere by manipulating the shot valve. The location of the shot ballast is such that by dropping shot, the vessel's trim can be corrected after picking up bottom samples or other material while submerged and carrying them at the forward part of the vehicle. The total capacity of shot ballast is 175 pounds.

Since the single-shot hopper provides the only ballast affecting trim that can be released under water, the vehicle will go down by the stern when shot is released. Trimming or heeling in other directions while submerged can only be done by moving weights inside the pressure hull.

#### **Battery Shift:**

Similar in operation and effect to the internal weight-shift trim system described above, several vehicles employ a trim system composed of movable batteries. The *MERMAID*-class vehicle is typical.

To compensate for changes in weight distribution in the longitudinal direction—which could occur either when equipment is moved or when the operator moves forward from his seat to a lying position—*MERMAID* is equipped with a battery shifting system.

When the central hydraulic power supply is working, trimming is affected via the hydraulic network and is hand controlled. The system permits the longitudinal inclination to be adjusted approximately  $\pm 20$  degrees.

The U.S. Navy's *MAKAKAI* also employs a battery-shift trim system, but it is used only on the surface to attain gross trim before the dive and cannot be adjusted again until the vehicle surfaces.

#### **Ballast Weight Drop:**

The submersible *DEEP VIEW*, in addition to internal movable ballast, has twenty 5-pound steel plates attached to its keel forward and aft. By individually dropping a fore or aft weight the vehicle can attain up/down bow angles. Because the application of this system results in an overall loss of negative buoyancy, 16 buoyancy blocks weighing 3 pounds each are located atop the hull. They are individually jettisonable and may be released to counteract any undesired gain in positive buoyancy attained through use of the trim system.

#### **Water Transfer:**

Similar in effect to fore/aft water transfer within the pressure hull, *BEAVER*'s external system consists of three spherical titanium tanks, one mounted aft (1,238-lb capacity) and two mounted port/starboard amidships of 943-pound capacity each (Fig. 6.12). A hydraulically driven pump transfers water between these tanks at 200 pounds/minute to gain  $\pm 27$ -degree up/down bow angles. This same system can also transfer seawater between the port/starboard tanks to attain list or roll angles of  $\pm 12$  degrees.

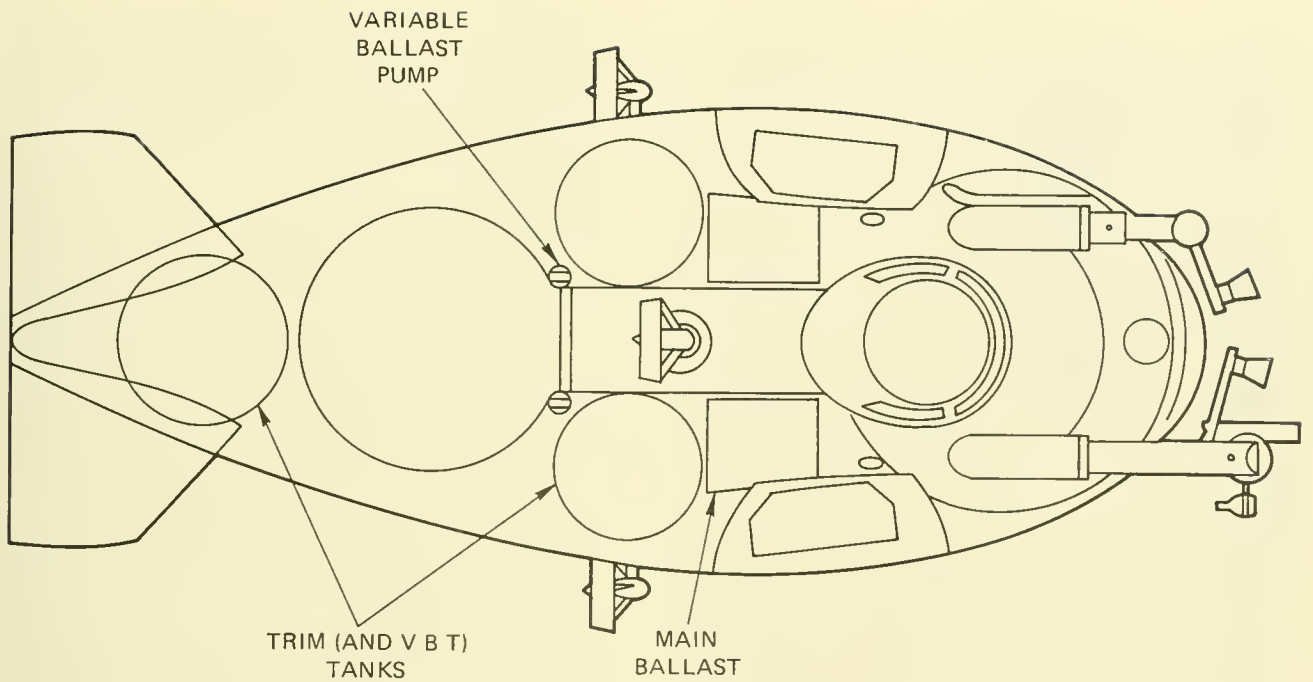

Fig. 6.12 Trim system components of BEAVER (top view).

**Oil Transfer:**

The trim system of *DOWB* is not so much a transfer of weight function as it is a displacement function. It consists of a central trim tank within the pressure hull, a fore and aft trim bladder and a hydraulic trim pump with associated valves, piping and fittings (Fig. 6.13). By transferring oil between the blad-

ders, to decrease or increase fore and aft displacement, an up/down bow angle of 2.5 degrees can be obtained.

With such ballast and trim systems at his disposal, the operator of a submersible attempts to carry out his mission. Some missions, however, provide options to frequent adjustments in ballast or trim. When a vehi-

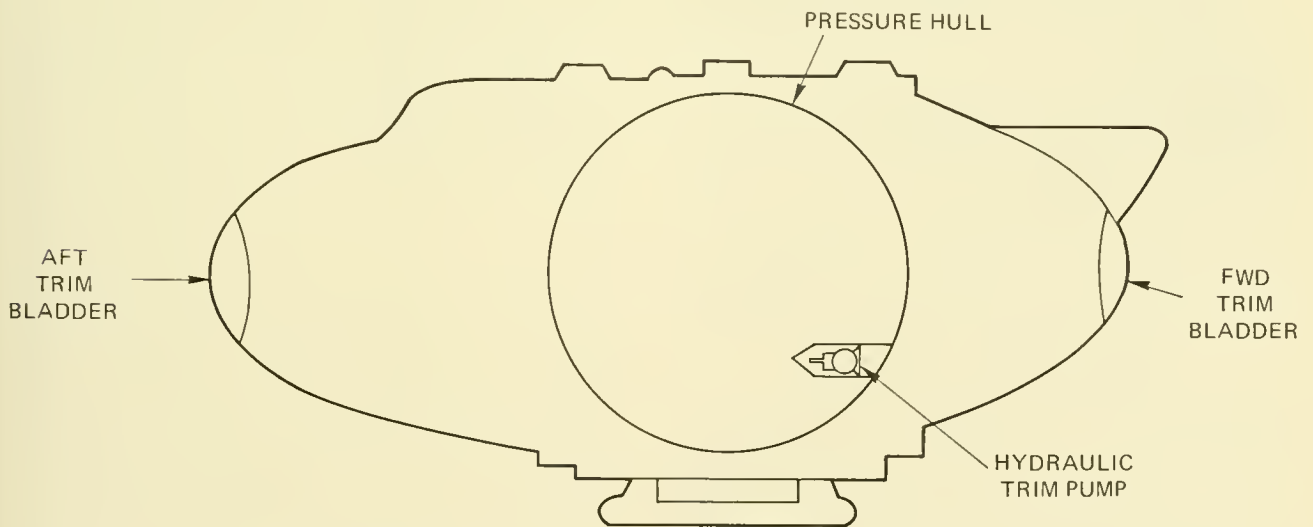

Fig. 6.13 Trim system components of DOWB (starboard side view).

cle is required to traverse or search the bottom over a large area, the pilot may elect to use some of these options; *ALUMINAUT* is an example. In its early operations, *ALUMINAUT* was fitted with three water-filled aircraft wheels enabling the vehicle literally to "taxi" along the bottom by first attaining very slight negative buoyancy and then propelling itself along with the wheels in contact with the sea floor. The procedure freed the pilot of making frequent trim or ballast changes as the bottom topography varied or as the crew moved about. The wheels were later replaced by iron skids which served the same purpose and were less troublesome. Obviously, this procedure can be applied only where the bottom is sufficiently smooth. One disadvantage to this procedure is that a sediment cloud, caused by disturbing the bottom, follows the submersible, and, if the current is following also, valuable bottom time is expended while waiting for the visibility-obscuring cloud to drift off or settle out of the water.

## REFERENCES

1. Rechnitzer, A. B. and Gorman, F. T. 1969 *Submersibles*. in *Handbook of Ocean and Underwater Engineering*, McGraw-Hill Book Co., New York, p. 9-63 thru 9-80.
2. Vincent, M. and Stavovy, A. B. 1963 *The promising aspects of deep-sea vehicles*. Paper No. 3 presented at the Annual Meeting of the Society of Naval Architects and Marine Engineers, 14-15 Nov. 1963, 16 pp.
3. Covey, C. W. 1964 *ALUMINAUT*. Undersea Tech., v. 5, n. 9, p. 16-23.
4. Talkington, H. R. and Murphy, D. W. 1972 *Transparent Hull Submersibles and the MAKAKAI*. Naval Undersea Research and Development Center, Report TP-283.
5. Mavor, J. W., Froehlich, H. E., Marquet, W. M. and Rainnie, W. O. 1966 *ALVIN, 6000-ft. submergence research vehicle*. Paper presented at the Annual Meeting, New York, N.Y., Nov. 10-11, 1966 of the Society of Naval Architects and Marine Engineers, n. 3, 32 pp.
6. Rockwell, P. K., Elliott, R. E. and Snoey, M. R. 1971 *NEMO, A New Concept in Submersibles*. NCEL TR-749, 68 pp.
7. Rosenberg, M. A. 1970 *Buoyancy materials for deep submergence applications*. Oceanology International, Mar. 1970, p. 30-32.
8. Dudt, P., Tinley, T. and Weishanr, F. 1973 *Lower-cost 34-LB Syntactic Foam for 20,000 ft. Depth Applications*. NSRDC Interim Report No. 1, SD Tech. Note SD-172-163, Bethesda, Md., 19 pp.
9. Piccard, A. 1956 *Earth, Sky and Sea*. Oxford University Press, New York, 192 pp.
10. Araki, A. 1972 *The operation by the HAKUYO*. Reprints from the Second International Ocean Development Conference, Tokyo, Japan, 1972, v. 1, p. 821-828.
11. Watson, W. 1971 *The design, construction, testing and operation of a deep-diving submersible for ocean floor exploration*. Paper presented in the Transactions of the Annual Meeting of the Society of Naval Architects and Marine Engineers, Nov. 11-12, New York, p. 405-433.



# 7

## POWER AND ITS DISTRIBUTION

Four types of power are used to perform work in manned submersibles: Electric, pneumatic, muscular and hydrostatic. Other forces also assist the vehicle through its mission, *e.g.*, gravity and buoyancy, but the discussion of these is beyond the scope of this chapter.

Electric power is the workhorse of the submersible fleet and batteries constitute the most commonly used on-board electrical source. Consequently, the major topic of this chapter is batteries and the transfer of their power to components and systems of a submersible. Pneumatic power, in the form of compressed air, is used primarily to empty ballast tanks of seawater; other uses are in pressure compensation systems and lock-out

chambers. Human muscle power is a significant source in shallow diving submersibles but less so in deeper vehicles. Hydrostatic power is used in the operation of pressure depth gages (Chapter 10) and in the pressure compensation of batteries and other components; its application is discussed under Pressure Compensation of batteries.

### MANUAL POWER

According to Cohn and Wetch (1), an average man can generate 50 to 100 watts of power for several hours before he is exhausted; this averages to 1 watt-hour/pound, and defines man as a low energy source. In spite of his shortcomings, with the help of

mechanical advantages he supplies the power required for many critical vehicle functions. In small, shallow vehicles manpower supplies many needs which can be grouped under such functions as push, pull, twist, turn and crank. In some vehicles, the application of manpower is direct and involves the following:

- Orientation of propulsion motors (*All Ocean Industries*),
- Control of dive planes and rudders (*PC-3A*),
- Dropping of emergency weights (*PISCES II*),
- Water deballasting with hand pump (*NAUILETTE*),
- Control of manipulator (*NEKTON, SEA OTTER*), and
- Water sampling with hand pump (*BEN FRANKLIN*).

In the majority of deep vehicles, these functions are accomplished by pushing a button which activates a pump or motor to perform the same task, but electricity is always in short supply and wherever the opportunity exists to use a mechanical rather than electrical component the designer will do so. There are limits, however, to the practical and physical aspects of transferring manual power through a pressure hull by means of a shaft and stuffing box. At 1,000 feet, virtually all manually-operated external components or systems are replaced by electric or electro-hydraulic mechanisms, the only notable exception being the mechanical dropping of emergency weights. In a few vehicles, *SEA OTTER* and the *PISCES* series, movement of a simple manipulator and jettisoning of various components is accomplished by manually pumping fluid through the hull to attain the desired reaction hydraulically.

## PNEUMATIC POWER

The section "Deballasting and Compressed Air" in Chapter 6 discusses the characteristics of compressed air as a power source in submersibles. It will suffice at this point to reiterate that in a great number of the shallow diving vehicles compressed air is used exclusively as the primary power source to force seawater out of main ballast tanks on

the surface and from both main and variable ballast tanks when submerged.

## ELECTRIC POWER

Electric power in submersibles is much like the weather; everybody talks about it, but nobody does much about it. Table 7.1 shows the kinds of electric power sources in 100 submersibles; 86 of these use lead-acid batteries, 1 uses a nuclear reactor, 2 derive their power from the surface, and the remaining vehicles use nickel-cadmium or silver-zinc batteries. On the other hand, the published literature on energy sources for undersea work abounds with accounts of the potential fuel cell applications. Yet, all submersibles constructed in the seventies and now under construction specify lead-acid batteries.

This literature imbalance is found in many other areas, *e.g.*, pressure hull materials and ballasting devices. The authors concentrate on the future, rather than the present. For example, as pointed out above, batteries constitute the major power source for all but 3 out of 100 submersibles, and lead-acid batteries dominate. Yet few can be found which deal with means of improving the output or construction of lead-acid batteries for this type application. There is also a complete absence of reports detailing the means used to distribute this power and their successes or failures. Bits and pieces of advice can be found in a few papers, but a major work on this aspect (lead-acid batteries and power distribution) of submersibles is lacking. As a result, the private builder is left to his own devices in designing electrical circuitry and selecting reliable components. It is not surprising, therefore, that historically and currently, electrical malfunctions turn out to be the most common cause of aborted submersible dives.

In a 1970 presentation at the Offshore Technology Conference in Houston, Texas, J. F. Rynewicz (2) made the following statement regarding Lockheed's *DEEP QUEST* and the submersible field at large:

*"Electrical problems, especially leakage in electrical cables, connectors, and circuit breakers, constitute the major area of need for improve-*

TABLE 7.1 SUBMERSIBLE POWER SOURCE CHARACTERISTICS

Submersible	Main Power Source	Type Battery	Pressure Compensated	Pressure Resistant Capsule	Inside Pressure Hull	DC Voltage Output	Total Power Capacity (kWh)	Other
All Ocean Industries	B	L-A	No	Yes	Yes	12	NA	
ALUMINAUT	B	S-Z	No	Yes	Yes	28, 115, 230	300	
ALVIN	B	L-A	Yes	—	—	30, 60	40.5	
AQUARIUS I	B	L-A	No	Yes	No			
ARCHIMEDE	B	N-C	Yes	—	—	24, 110	100	
ARGYRONETE	B	L-A	Yes	—	—	NA	1,200	diesel sur- face power
ASHERAH	B	L-A	Yes	—	—		21.6	
AUGUSTE PICCARD	B	L-A	No	No	Yes	6, 12 110, 220	625	
BEAVER	B	L-A	Yes	—	—	28, 64, 120	55	
BEN FRANKLIN	B	L-A	Yes	—	—	28, 112, 168	756	inverters for AC power
BENTHOS V	B	N-C	No	No	Yes	NA 24, 36	NA	
DEEP DIVER	B	L-A	No	Yes	No	120, 240	23	
DEEP JEEP	B	L-A	Yes	—	—	NA	7	
DEEP QUEST	B	L-A	Yes	—	—	28, 120	230	inverter for AC power
DEEPSTAR 2000	B	L-A	Yes	—	—	28, 120	26.5	
DEEPSTAR 4000	B	L-A	Yes	—	—		49.6	inverter for AC power
DEEPSTAR 20000	B	S-Z	Yes	—	—	28, 112	NA	
DEEP VIEW	B	L-A	Yes	—	—	12, 24, 48	16	
DOSTAL & HAIR	B	L-A	Yes	—	—	NA	16.2	
DOWB	B	L-A	Yes	—	—	120 inverted dive Ex to AC	40	inverters for AC power inverter for AC power
DSRV-1 & 2	B	S-Z	Yes	—	—	112	58	
FNRS-2	B	L-A	Yes	—	—	NA		
FNRS-3	B	S-Z	No	No	Yes	NA	30	
GDLD FISH	B	L-A	No	No	Yes	NA	NA	gasoline engine for surface
GUPPY	Surface Generator	—	—	—	—	440 110	—	tethered
HAKUYO	B	L-A	No	Yes	No	24, 120	14.4	
HIKINO	B	L-A	No	No	Yes	18, 24	2.3	
JOHNSON SEA LINK	B	L-A	No	Yes	No	NA	32	
KUMUKAHI	B	L-A	Yes	—	—	12	5.1	data incomplete
KUROSHIO II	Surface Generator	—	—	—	—	104	—	tethered
MAKAKAI	B	L-A	Yes	—	—	6, 30, 120	36	
MERMAID I	B	L-A	No	Yes	No		36	

B = Battery    L-A = Lead-Acid    N-C = Nickel-Cadmium    S-Z = Silver-Zinc    NA = Data Not Available

TABLE 7.1 SUBMERSIBLE POWER SOURCE CHARACTERISTICS (Cont.)

Submersible	Main Power Source	Type Battery	Pressure Compensated	Pressure Resistant Capsule	Inside Pressure Hull	DC Voltage Output	Total Power Capacity (kWh)	Other
MINI DIVER	B	L-A	NA	NA	NA	NA	NA	
NAUTILETTE	B	L-A	No	Yes	Yes	24	4.4	
NEKTON A, B, C	B	L-A	No	No	Yes	24, 48	4.5	
NEMO	B	L-A	Yes	—	—	24, 120	15	
NEREID 330 & 700 NR-1	B	L-A	No	Yes	No	24, 220	40	
	Nuclear Reactor	—	—	—	—	NA	NA	
PAULO I	B	L-A	No	Yes	Yes	6, 12, 24	5.2	
PC3-X	B	L-A	No	Yes	Yes	NA	11	
PC-3A (1 & 2)	B	L-A	No	Yes	Yes	NA	7.5	
PC5C	B	L-A	No	Yes	No	12, 120	16	
PC-3B	B	L-A	No	Yes	No	NA	26	
PS-2	B	L-A	No	Yes	No	24, 120	17	
PISCES I	B	L-A	Yes	—	—		66	
PISCES II, III, IV, V	B	L-A	Yes	—	—		70	
						12, 28		inverter for AC power
SDL-1	B	L-A	Yes	—	—	60, 120	68	
SEA CLIFF & TURTLE	B	L-A	Yes	—	—	30, 60	45	
SEA OTTER	B	L-A	No	Yes	Yes		13.8	
SEA RANGER	B	L-A	No	Yes	No	NA	43.5	
SEA-RAY	B	L-A	No	Yes	Yes	NA	15	
SHELF DIVER	B	L-A	No	Yes	No	NA	37	
								inverter for AC power
SHINKAI	B	L-A N-C	Yes	—	—	NA	200	
SNOOPER	B	L-A	Yes	—	—	NA	9.7	
SP-350	B	L-A	Yes	—	—	NA	13	
SP-500	B	L-A	Yes	—	—	NA	6.8	
								inverter for AC power
SP-3000	B	L-A	Yes	—	—	120, 26	47	
SPORTSMAN 300	B	L-A						
SPORTSMAN 600	B	S-Z	No	Yes	Yes		4.2	
STAR I	B	L-A	Yes	—	—	12, 24	4.7	
								inverter for AC power
STAR II	B	L-A	Yes	—	—	±12, 24, 115	14.8	
								inverter for AC power
STAR III	B	L-A	Yes	—	—	±12, 24, 115	30	
SUBMANAUT (Helle)	B	L-A	No	Yes	Yes	NA	3.5	
								diesel engine for surface
SUBMANAUT (Martine)	B	L-A	No	Yes	No	24, 115, 230	91	
SUBMARAY	B	L-A	No	Yes	Yes	NA	4.5	
								inverter for AC power
SURV	B	L-A	No	Yes	No	—	12	
SURVEY SUB 1	B	L-A	No	Yes	No	24, 120	49.9	

B = Battery    L-A = Lead-Acid    N-C = Nickel-Cadmium    S-Z = Silver-Zinc



TABLE 7.1 SUBMERSIBLE POWER SOURCE CHARACTERISTICS (Cont.)

Submersible	Main Power Source	Type Battery	Pressure Compensated	Pressure Resistant Capsule	Inside Pressure Hull	DC Voltage Output	Total Power Capacity (kWh)	Other
TECHDIVER	B	L-A	No	Yes	Yes	NA	10	
TOURS 64 & 66	B	L-A	No	Yes	Yes	NA		diesel engine for surface
TRIESTE II	B	L-A	Yes	—	—	NA	145	
TRIESTE III	B	S-Z	No	Yes	Yes	NA	145	
VAST MK II (K-250)	B	L-A	No	Yes	Yes	NA	3.5	
VOL-L1	B	L-A	No	Yes	No	24, 120	52	
YOMIURI	B	L-A	No	Yes	Yes	NA	45	diesel for surface power

B = Battery    L-A = Lead-Acid    N-C = Nickel-Cadmium    S-Z = Silver-Zinc

*ment in deep submergence components. The time, energy and dollars lost due to the malfunction of a component are most certainly always several orders of magnitude greater than the original cost of the component. The lesson herein is that submersible designers must insist on the use of materials and combinations of materials that will provide high reliability for many years in the ocean's hostile, corrosive depths."*

In the 4 years since Rynewicz's statement, there has been some decrease in the "electrical problem." Rather than a concerted effort on the part of submersible builders to single-mindedly find reliable materials and components, the problem has been tackled individually, e.g., by operators, and through the process of elimination suitable answers have been found in some cases, and "some times" answers in others.

In one instance, the builder (International Hydrodynamics Ltd.) went to the extreme measure of abandoning all commercially-available connectors and now manufactures its own.

### Application

The only task submersibles could accomplish without electricity would be to descend and ascend, and this would be done in total

darkness and incommunicado. To say electrical power is critical is a gross understatement; it is the lifeblood of undersea work as the following indicates:

**Propulsion:** All submersibles use electrically-powered motors for lateral or vertical maneuvering.

**Life Support:** All submersibles but one, **BEN FRANKLIN**, use electrically-powered carbon dioxide scrubbers.

**Communications:** All two-way sub-to-surface communication devices are electrically powered.

**Illumination:** All internal and external lighting is electrically powered.

**Work and Operating Instruments:** Virtually all scientific and engineering instruments, as well as those used to control and operate the vehicle, are driven by electricity.

**Ballast Drop:** The majority of vehicles depend upon an electrical impulse or signal to activate weight drops or jettison instruments.

**Maneuvering:** The majority of vehicles depend upon electricity to orient their propulsion devices or dive planes and rudders.

**Sensors:** Virtually all status sensors (trim tank level indicators, MBT and VBT level sensors, etc.) are electrically powered.

**Emergency Indicators:** All seawater leak indicators depend upon the initiation or termination of electrical current.

**Tracking/Navigation:** All routine tracking and navigation systems depend upon electricity.

**Hydraulics:** Virtually all hydraulically-powered devices require electricity to pump hydraulic fluid.

There are exceptions to the above, but they only accentuate the widespread and essential role electricity plays in deep submergence, generally, and manned submersibles, specifically. It is not surprising, then, that the recent literature on submersibles contains an inordinate amount of discussion regarding electrical power and the means to increase its output and endurance. It is interesting to observe that the majority of early literature on submersible design dealt with pressure hull materials and later with power sources. Apparently the first order of business was to dive safely; the next item was to accomplish something once safety was attained.

## Terminology and General Considerations

The only general statement which may be made regarding power supply and distribution in submersibles is that they most often use lead-acid batteries which are usually recharged from a surface support ship after each dive. While approaches to electrical power distribution vary widely, system requirements are similar, and it is around such requirements that basic submersible electrical terminology is defined.

In many respects, electric power generation and distribution aboard a submersible is similar to that aboard a surface ship, but the problems are compounded in a submersible by the operating environment: High pressure, low temperature and an operating medium which itself is an excellent electrical conductor, namely seawater. The characteristics of the operating environment and the constraints imposed by occupant safety combine to make problems of electric power generation and distribution in submersibles and submarines quite unique. A basic definition of terms follows, while Figure 7.1 presents a graphical representation of the components cited:

**Power Generation:** This requirement is met primarily by **Secondary Batteries** consisting of lead-acid (Pb-acid), nickel-cadmium (Ni-Cd) or silver-zinc (Ag-Zn) cells which are rechargeable to their rated capacity (measured

in ampere-hours) for many cycles. In submersibles the Pb-acid batteries are conventional and similar to automobile batteries.

**Power Distribution:** Connectors and cables are used to carry the power from the batteries. **Cables** provide a waterproof, insulated casing for the current-carrying conductor(s), and **connectors** are devices, generally molded to either end of a cable, consisting of a plug and receptacle which provide a waterproof attachment to the energy source or, more commonly, to a penetrator. An **electrical hull penetrator** is a specially designed receptacle which permits passage of current through the pressure hull or any other casing containing an electrical component.

**Power Changers:** Batteries generate direct current (DC). Many instruments and propulsion systems however, operate on alternating current (AC). Consequently, **inverters** are used to change DC power to AC. The inverters may be carried within or external to the pressure hull. Other components or sub-systems may operate on DC voltages which are lower than that generated by the batteries. In this case a **converter** is used. Basically a converter provides the functions of a step-down transformer and an inverter—that is, it lowers the voltage and changes AC to DC. This is a more energy conserving approach than placing a series resistor in the circuit. In practice, then, an inverter first changes battery DC to AC which is then acted on by the converter to yield DC power at the required voltage.

**Power Protection:** Three approaches are used in protecting batteries from seawater and pressure: 1) **pressure-compensation** (Fig. 7.1) wherein the battery is placed within a sealed and vented case filled with a dielectric fluid (usually oil) and connected to a compensating fluid reservoir which acts to maintain a zero or slightly positive pressure differential across the enclosed oil/seawater face; 2) **pressure-protection** wherein the battery is enclosed in a **pressure-resistant** pod outside the pressure hull and maintained in a dry, 1-atmosphere environment; 3) interior location where the battery is placed within the pressure-hull to protect it from seawater and pressure. No provisions are made to main-

tain a constant battery temperature in submersibles, the consequences of which will be discussed later.

**Protection from the Power:** Faulty conductor protection may lead to short-circuits, while inappropriate cable routing or shielding may result in *electromagnetic interference (EMI)*. In the former situation both the human occupants and the electrical subsystems must be protected; in the latter, only the electrical subsystems must be protected. The causes and results of short-circuits are legion. To state the obvious, the ideal solution is prevention through sound circuit design and construction. Unfortunately, a perfect solution is not always attained and devices are required to still the rampaging current before it can cause critical damage. **Fuses** and **circuit breakers** provide this protection by interrupting the circuit when it reaches or exceeds a certain amperage level. In the small confines of a submersible, it is not uncommon to have high voltage cables (*e.g.*,

propulsion power) immediately adjacent to cables carrying power or signals from an instrument. In this case the EMI from the high voltage cable may seriously interfere with the output on the signal cable. Shielding or adequate physical separation of the two cables prevents such interference.

**Power Monitors:** To ascertain the state of the batteries, equipment inside the pressure hull may include one or all of the following: **Ampere Hour Meter** to monitor and display the battery current used or remaining, **Voltmeter** to read battery voltage or a **Ground Measuring System** to detect ground currents on the battery and a **Megohm Meter** to measure ground resistance on other external equipment. A few submersibles carry none of these measuring/monitoring devices, others carry one or two. **Indicators** may be included in the Battery Manifold Oil Reservoir to indicate the level of salt water incursion, or in the Battery Vent Valve to indicate when salt water has entered the vent valve reservoir.

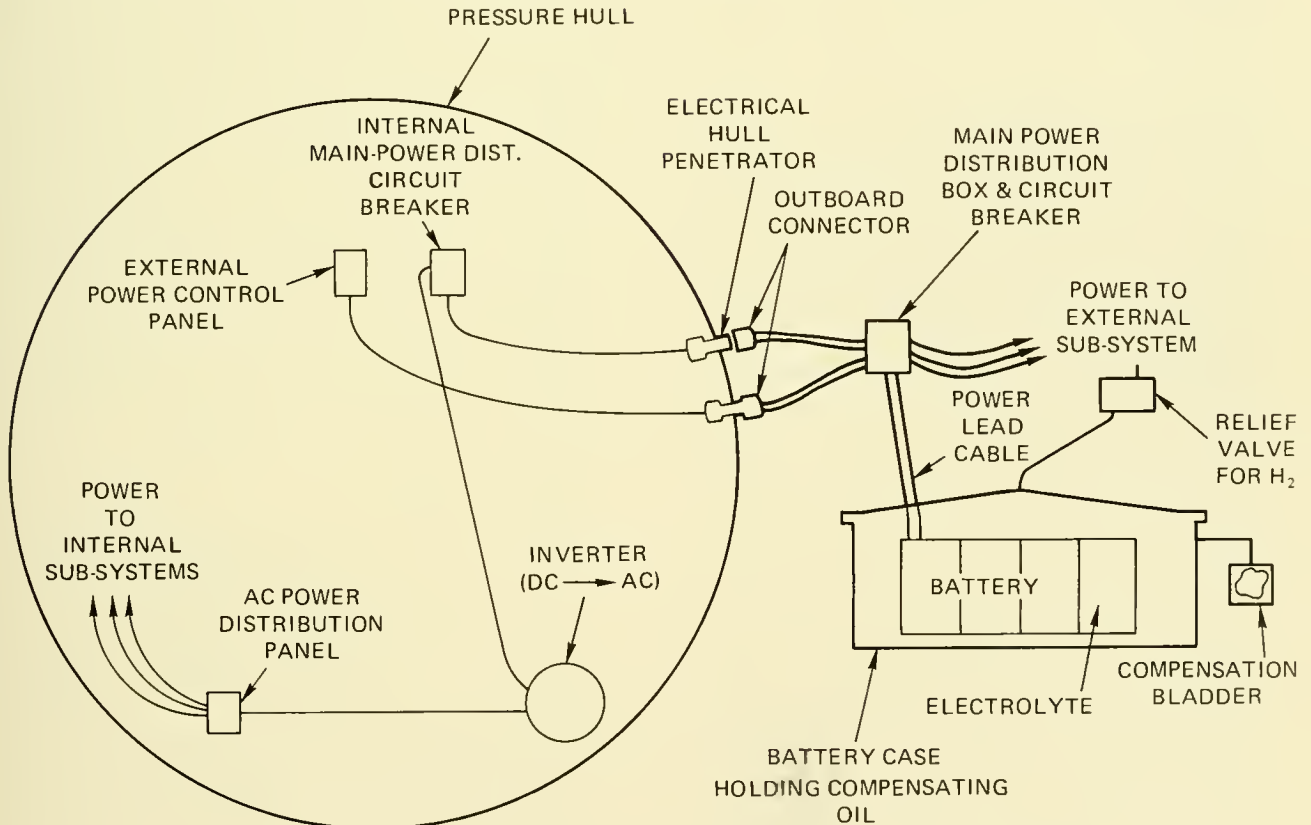

Fig. 7.1 Example of electrical power and distribution arrangements in a submersible.

**Power Regeneration:** The majority of submersibles recharge batteries after each dive. This is accomplished with the vehicle aboard or alongside its support craft which carries a battery charger. A few submersibles carry their own diesel-electric motor to charge the batteries while they are surfaced.

In an extremely simplified manner, such is the genesis, distribution and control of electrical power in manned submersibles. The variations on this theme equal the number of past, present and future vehicles. The reason for such diversity is found in the several factors which enter into the choice of a submersible's power source.

In a discussion of electrical power supplies to meet the needs of deep submersibles, Louzader and Turner (3) identify the following as considerations important in the evaluation of candidate power sources:

- Total Power Requirements
- Weight and Volume
- Operational Handling
- Maintainability and Repair
- Reliability
- Cost

### **Total Power Requirements**

The total power required in a submersible depends upon the vehicle's primary mission and projected submerged endurance. These, in turn, are governed by the weight and volume available for the power package. The major power user is propulsion. Running a close second, and sometimes exceeding propulsion are external lighting and scientific or work equipment requirements. Hotel load (life support, communications, avoidance sonar, monitoring instruments) is a consumer of power which must be dealt with on a continuing basis, and, finally, the prudent operator will maintain some amount (25%) of power in reserve.

An examination of Table 7.1 reveals that the total power capacity (kWh) of submersibles ranges from 2.5 to 1,200 kWh. Of the 83 vehicles for which there is information, 74 carry less than 100 kWh while the remainder, nine, exceed this value. Further examination shows that 61 vehicles carry 50 kWh or less. The distribution and nature of this power varies from vehicle-to-vehicle. Some

operate solely with 12 VDC (*KUMUKAHI*), while others operate with 12, 28, 60 and 120 VDC and carry an inverter to supply AC power as well, e.g., *SDL-1*. There are no hard and fast rules governing total power requirements or rated voltages, but once the total power capacity is established, one can calculate how much will be available for various instrument or machinery functions and for what mission profiles. The ideal procedure, however, would be to determine the power requirements through power spectrum analysis of the vehicle's intended mission(s) and then design the vehicle and its power system accordingly. Many builders have followed this latter procedure, but in several instances, it would appear that a more casual approach was taken.

An example of a power spectrum analysis is presented in Figure 7.2 which was performed by Bodey and Friedland (4) for a small submersible on a "typical" mission. First, the authors divided the overall mission into categories (pre-dive, dive, etc.) where the operation of various electrical devices could be prognosticated. Then, an operating time for each device was assumed and multiplied by the power it would require (time  $\times$  amps  $\times$  voltage)—based on manufacturer's specifications. Summing each column provided the power for each category and, hence, the total power to complete the 6-hour mission. It is important to note that almost one-half of the total kWh was allocated for reserve power. Such power analysis is unavoidable when the owner plans to lease the vehicle's services to a user who desires to operate his own electronic equipment in addition to that listed in Figure 7.2.

### **Weight and Volume**

The small size of most submersibles places severe restraints on the weight and size of possible power systems. The decision to locate the system inside or external to the pressure hull is critical in determining the total power a vehicle will carry. If the power system is located within the hull an increase in propulsion power is needed because of the added hull weight. This also decreases the vehicle's payload and submerged endurance and limits the volume available for internal instrumentation. Locating the system exter-

EQUIPMENT	PREDIVE	DIVE	SEARCH	SET-UP	STAND-BY	WORK	EMERGENCY	CLIMB	DOCKING
MECH-ARMS				•		•			
HYDRAULIC SYSTEM	•	•	•	•	•	•	•	•	•
WRENCH							•		
PROPULSION	•	•	•	•			•	•	•
WINCH						•			
VEHICLE LIGHTS		•	•	•	•	•	•	•	
TV LIGHTS						•			
GYRO COMPASS	•	•	•	•	•	•	•	•	
SCANNING SONAR	•	•	•				•	•	
TRANSCIVER	•								•
PAN & TILT						•			
TV						•			
LIFE SUPPORT	•	•	•	•	•	•	•	•	•
POWER (kW)	3	3	5.1	3.5	0.9	2.5	7.7	3.2	2.5
TIME HR-MIN	:30	:10	:30	:15	2:40	1:00	:30	:10	:15

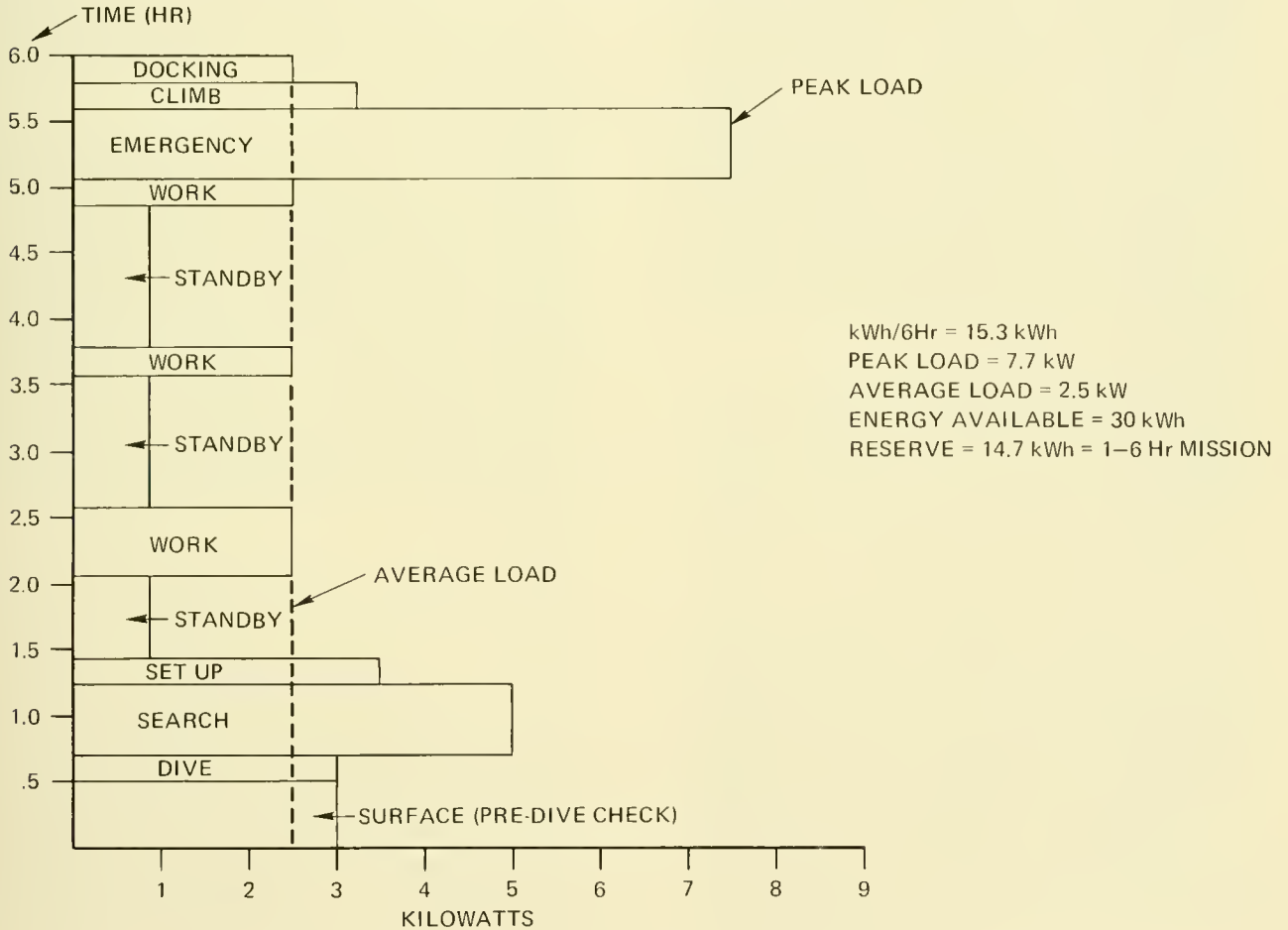

Fig. 7.2 Power spectrum for a typical six-hour mission. [From Ref. (4)]

nal to the hull alleviates the internal volume problem and significantly eases the weight (or buoyancy) problem. The potential for short circuits or other failures due to leakage is virtually nil when the power system is inside the hull, but the gain is partially offset by occupant safety considerations.

### Operational Handling

Recharging or turn-around time of battery-type power systems and fuel cells is an important factor. Submersibles of the **DEEP-STAR** series require 6 to 8 hours for recharging between each 4- to 6-hour dive. Vehicles of the **BEN FRANKLIN** and **ALUMINAUT** variety require 12 hours and longer. The only reported experience with fuel cells (4) indicates that very little time is required to place new fuel and oxidant aboard the vehicle. It is the practice with several vehicles simply to replace a used battery package with a charged one after each dive, thereby significantly decreasing turn-around time. This latter option assumes that the design of the vehicle permits such modular replacement. Short turn-around time is critical to the economic utilization of a submersible operating in areas where weather dictates the deployment of vehicles. In the North Sea, for example, periods of relative calm can be quite short, and the submersible requiring 6 to 8 hours turn-around time works at a disadvantage.

### Maintainability and Repairs

Few submersibles are furnished with an enclosed area for repairs or maintenance aboard their support ship. Consequently, weather plays an important role in the timely correction of malfunctions or in routine maintenance. Where repairs to an internal power package are required the problem remains, but is less severe because the work may be performed within the shelter of the pressure hull and, depending upon the nature of the casualty, may be performed during the dive itself. External power systems are limited to repairs only when the vehicle is aboard ship or ashore. **BEN FRANKLIN** and **ALUMINAUT** present the advantages and disadvantages of the opposing power system location strategies. Both vehicles are generally towed to the operating site and

remain in the water during the operation because their size and weight preclude launch/retrieval in a routine fashion. If **BEN FRANKLIN** undergoes a significant battery malfunction, the vehicle must be towed to a port where facilities are available to lift the 142-ton vehicle out of the water. Conversely, **ALUMINAUT**, with silver-zinc batteries inside the pressure hull, may be repaired in the water and on site—thereby negating a long tow and expensive lift to ascertain the nature of the problem.

To digress for a moment, the future submersible designer should note that while **ALUMINAUT's** internal batteries allow easier maintenance and repair than **BEN FRANKLIN's** external, keel-mounted, lead-acid batteries, **ALUMINAUT's** electrical penetrators are below its waterline. Hence, when **ALUMINAUT's** penetrators fail (as was the case in a 1968 Puerto Rican operation) it must be lifted out of the water. **BEN FRANKLIN**, on the other hand, has all its electrical penetrators above the waterline, thereby allowing in-water repairs.

### Reliability

There are a variety of candidate power systems which offer considerable advantages over lead-acid batteries, but the extreme inhospitality of the deep sea, and the size and weight limitations imposed on the system by small submersibles precludes a number of redundant measures incorporated in most marine designs (3). For such reasons and the overriding need for a reliable power source, many potentially better power systems fail to make it through the competitive selection process.

### Cost

The U.S. Navy's **NR-1** receives its power from a nuclear reactor and may remain submerged and cruising for 30 days or longer. **NR-1** is acknowledged to have cost some \$99 million. What portion of this value represents the power package is unknown, but is certainly at least an order of magnitude beyond the budgets of present, private submersible builders. Likewise, the increased size and weight of the vehicles needed to accommodate nuclear reactors would impose severe penalties on mobility and maneuvera-

bility for certain types of missions. In the simplest example, the *All Ocean Industries'* vehicle employs two 12-volt lead-acid batteries inside its pressure hull; the total cost of this power package is somewhere around \$70. Cost and reliability are so intertwined that it is impossible to evaluate one without the other using the present yardsticks of evaluation. Confidence or reliability in a power system is achieved through demonstrated performance. For this reason the lead-acid battery (in use since 1901 in U.S. Navy submarines) is irresistible. For other systems (fuel cells, thermoelectric generators and other batteries) to attain this degree of confidence they must demonstrate their reliability, but without a concentrated research and development program which will both demonstrate reliability and decrease purchase cost, it is difficult to foresee a near-future competitor to lead-acid batteries.

In the final analysis, the nature, location and total power output of a submersible's power system are compromises of design and operational trade-offs. Without compromising occupant safety, sound arguments can be advanced for systems internal to the pressure hull as well as external. Both solutions are accompanied by disadvantages for which there is no optimum solution in one submersible. Perhaps future developments will help to alleviate this problem, but for the present let us examine the power sources with which submersible builders have dealt: Batteries, fuel cells and nuclear reactors. Though not having a "self-contained" power source, surface-powered vehicles such as *GUPPY* and *KUROSHIO II* satisfy all other requirements of a submersible; hence, aspects of their cable-supplied power systems are briefly described.

## BATTERIES

Batteries generate power through the flow of electrons from a negative (anode) to a positive (cathode) electrode immersed in a conducting (electrolyte) medium (usually a liquid). The basic electrochemical unit (anode, cathode, electrolyte) is called a *cell*; the finished, boxed unit is the battery and it may consist of one or many cells. After a period of

time, the flow of electrons from anode to cathode (discharging) will weaken, and, for further use, the electron flow must be reversed by recharging to bring the cell back to its rated strength. Cells that can be recharged for many cycles are called *secondary cells*; cells that cannot normally be recharged—e.g., where the electrodes are depleted—are called *primary cells*. Secondary cells are the major suppliers of power in submersibles. Primary cells are frequently used to furnish emergency power or power to ancillary components such as pingers or transponders. Our main concern here is with secondary cells or batteries, of which three types have been used in submersibles: Lead-acid, nickel-cadmium and silver-zinc. The classification of batteries is derived from the substance comprising the electrodes (silver-zinc, nickel-cadmium) or from the substance comprising the electrodes and electrolyte (lead-acid). The electrolyte in the silver-zinc and nickel-cadmium batteries is alkaline.

While there is a lack of reported studies aimed at improving the performance and packaging of secondary batteries, there are several excellent reports detailing the characteristics of these power sources in the marine environment and other analyses exist which compare the advantages and disadvantages of one source against the other. The author has relied heavily on these studies to provide a state-of-the-art summary of the characteristics and properties of secondary batteries for deep submergence. A second topic—the means used to protect these sources from seawater and pressure—is dealt with under Protection and Pressure Compensation.

### Characteristics

In 1968 the National Academy of Sciences published a report (5) on energy system requirements and technology for undersea applications which cited the following advantages and disadvantages of conventional batteries relative to other energy sources.

#### Advantages:

- a) Basically simple construction where all components are self-contained within the battery.

- b) Operate at ambient deep-sea pressure and thereby conserve pressure hull weight.
- c) No moving parts preclude generation of noise or vibration.
- d) Operate at temperatures well below to well above those encountered within the sea.
- e) Highly reliable, and failure occurs one cell at a time such that battery operation may continue with only slightly diminished output.
- f) Available commercially in a large variety of types, sizes and configurations, and, for the most part, developmental costs have already been paid.

**Disadvantages:**

- a) Energy densities (energy per unit weight) and specific energies (energy per unit volume) are low.
- b) Designed for operation at power levels of not more than a few tens of watts per pound and a few kilowatts per cubic foot (silver-zinc cells are an exception).

The report concludes that, among the various conventional batteries available, silver-zinc batteries appear most attractive for undersea application. It also presents a summary of secondary battery characteristics which is shown in Table 7.2. An analysis of Table 7.2 reveals that silver-zinc cells achieve the highest energy density (watt hours/lb) and lead-acid the lowest with

nickel-cadmium somewhat in between. Conversely, initial costs are in the reverse order. Penzias and Goodman (6) point out that there is significant salvage value, however, in the silver of a silver-zinc cell while the lead in a lead-acid battery is hardly worth recovering.

**Discharge Rate and Temperature**

According to Cohn and Wetch (1), most battery manufacturers define standard conditions as room temperature and low discharge, and Howard (7) standardizes this condition as a 5-hour discharge at 80°F. Voltage profiles of various secondary cells are shown in Figure 7.3 and clearly demonstrate the steady output of silver-zinc and nickel-cadmium cells. Curves presented by Kisinger (8) show that the highest energy per pound from secondary batteries (lead-acid; silver-zinc) is obtained at slow discharge rates. In short, to realize the most energy, batteries should be used under load conditions which will keep the drain on them to a minimum. Conversely, of course, a high discharge rate reduces the total amount of energy that can be taken from a battery.

In general, as temperature decreases the withdrawal of current becomes more difficult because the increasing viscosity of the electrolyte hinders the passage of reactants and products to and from electrodes (9). High temperatures are only a problem if they are

**TABLE 7.2 SUMMARY OF SECONDARY BATTERY CHARACTERISTICS [FROM REF. (5)]**

Type	Anode	Cathode	Electrolyte	Temp. °F	Open circuit voltage (V)	Typical operating voltage (V)	Theoretical energy density (Wh/lb)	Actual energy density (Wh/lb)	(Wh/in. <sup>3</sup> )	Maximum power density (W/lb)	(W/in. <sup>3</sup> )	Cost* (\$/kWh)	Operating Life	Typical no. of cycles	Remarks
Conventional Lead-acid	Pb	PbO <sub>2</sub>	H <sub>2</sub> SO <sub>4</sub>	-40-140	2.2	1.7-2.1	80-115	5-20	0.4-1.2	15-30	1.2	0.09(60)	2-14 yr	1500	conventional lead storage cell; presently used for submarines, automobiles, etc.
Nickel-cadmium	Cd	Ni oxides	KOH	-40-140	1.35	1.0-1.3	105	12-15	0.7-1.0	15	1.5	0.21(700)	4-6 yr	1000-2000	available as completely sealed cell
Silver-zinc	Zn	AgO	KOH, ZnO	0-140	1.8	1.3-1.6	205	30-80+	1.8-5.6	170	7.2	8.40(800)	6-18 mo	10-200	high capacity and very high drain rates; low cycle life; expensive

\* First value is cost/kWh of energy drawn from battery during anticipated cycle life. Bracketed value is initial cost.



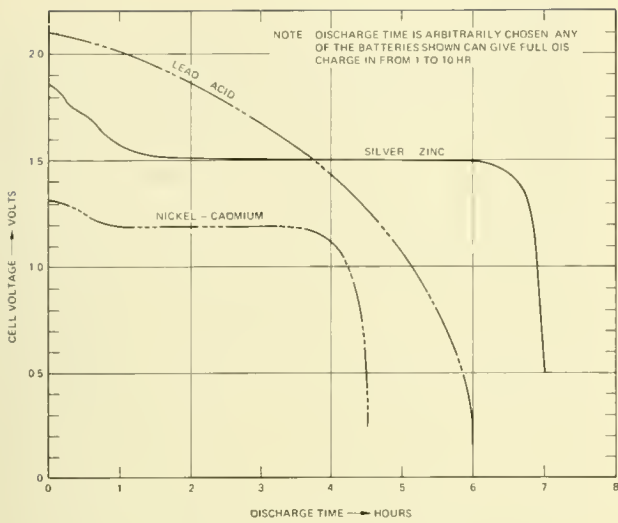

Fig. 7.3 Voltage profile of three secondary batteries

high enough to boil off the electrolyte, deteriorate the separators or distort the battery case. In deep submersible operations, consideration is generally given to low, rather than high temperatures because the operating en-

vironment is on the low temperature side. Normal operating temperatures of most secondary batteries are between 65° and 90°F. While water temperatures in excess of 90°F are quite unusual, deck temperatures in the tropics can exceed this value and should be considered when the submersible is out of the water. Water temperatures as low as 30°F may be encountered in the ocean, and deck temperatures below 0°F can be anticipated in the high latitudes. Performance data from various cells are presented in Table 7.3 and show the effects of temperature and discharge rate. The dashes in this table indicate the need for heaters to warm the cells. Cohn and Wetch (1), who present an excellent technical summary of all present and potential undersea power sources, recommend heaters in extreme cold to assure a more normal voltage profile throughout the discharge, and they point out that it is possible to have a higher voltage at cut off than at starting because of the warming of the active surfaces during normal discharge.

TABLE 7.3 RELATIONSHIP OF TEMPERATURE, DISCHARGE RATE, AND PERFORMANCE [FROM REF. (10)]

Battery Type	Cell Rated Capacity, (amp-hr)	Discharge Rate, (amp)	Potential at midpoint, V			Capacity, amp-hr, % rated		
			80°F	0°F	-40°F	80°F	0°F	-40°F
Lead-acid	5	0.5	1.95	1.89	1.85	100	54	30
		1.0	1.92	1.84	1.80	88	50	21
		10.0	1.81	1.60	1.40	46	16	3
	60	10.0	1.92	1.89	1.82	100	54	26
		25.0	1.90	1.80	1.65	87	31	10
		50.0	1.87	1.70	---	63	18	---
Nickel-cadmium	5	100.0	1.70	---	---	39	---	---
		1.0	1.22	---	---	100	---	---
		10.0	1.11	1.05	1.05	94	67	21
	75	10.0	1.23	1.16	1.14	100	80	64
		25.0	1.20	1.14	1.06	97	82	48
		50.0	1.13	1.07	1.00	94	72	34
Silver-zinc	5	100.0	1.17	---	---	82	---	---
		0.5	1.52	1.45	---	100	75	---
		1.0	1.50	1.42	---	96	70	---
	60	10.0	1.40	1.26	---	85	63	---
		25.0	1.49	1.42	---	97	79	---
		50.0	1.48	1.42	---	92	75	---
		100.0	1.42	1.30	---	84	69	---

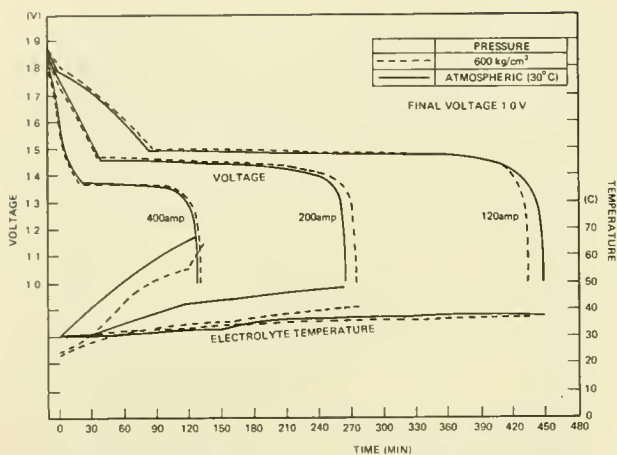

Fig. 7.4 Silver-zinc cell discharge characteristics under high pressure. [From Ref (12)]

## Pressure

In 1963, Horne (9) stated that the effects of pressure on battery performance should be slight, and subsequent experience proved this correct. More recently, Funao *et al.* (12) performed a number of experiments on silver-zinc secondary batteries. One result of their studies is shown in Figure 7.4 and indicates that there is no appreciable difference in capacity at atmospheric pressure than at 600 kg/cm<sup>2</sup> (8,532 psi). The range of

fluctuation in electrolyte level due to pressure was found to be larger than the range due to discharge and the electrolyte did not regain its original level after pressure was removed. The authors could not explain the phenomenon and suggest further study of this irreversible process.

Summarizing Horne's and others' observations and his own, Work (11) concluded that pressure might well be beneficial to battery performance by: 1) Increasing the electrolyte conductivity (5 percent in Pb-acid; 2 percent in Ag-Zn), 2) reducing the volume of any gas at or in a porous electrode making more electrolyte available at the surface and effectively increasing current density, and 3) through some unknown mechanism, increasing the power and providing greater watt-hour efficiency.

## Cell Life and Cycling

For all practical purposes the life of a secondary battery begins when the electrolyte is introduced. At this point the battery is said to be activated and its useful longevity is termed wet life or shelf life. In submersible operations a battery is charged before and after each dive, and its usefulness

TABLE 7.4 CELL CHARACTERISTICS OF THREE BATTERY TYPES [FROM REF. (10)]

Battery type	Composition, charged state			Cell potential, V		Time to discharge			Shelf life in charged condition		Life in operation				
	Pos.	Neg.	Electrolyte	Open circ.	Discharging	Fast-est, (min)	Av., (hr)	Slow-est, (days)	Shelf life if discharged (wet)	Without maintenance	With maintenance	Charge loss, %	Shelf life	Life in operation	
Lead-acid . . .	PbO <sub>2</sub>	Pb	H <sub>2</sub> SO <sub>4</sub>	2.14	2.1-1.46	3-5	8	>3	Not permitted	Low-rate: 15-20%/yr	Days	30-45 days	Years	To 500	To 14 yr
Nickel-cadmium . . .	NiO <sub>2</sub>	Cd	KOH	1.34	1.3-0.75	5	5	>3	Years	Pocket: 20-40%/yr Sintered: 10-15%/mo	Months Weeks	30-45 days	Years	100-2,000 25-500	8-14 yr 4-8 yr
Silver-zinc . . .	AgO	Zn	KOH	1.86	1.55-1.1	<0.5	5	>90	Years	15-20%/yr	3-12 mo	6 mo	1-2 yr	100-300 low dis. 5-100 high dis.	1-2 yr

SOURCE: F. O. Yeaple, Dry Cell Performance, *Prod. Eng.*, 36:160 (1965).

to the operator is measured in terms of the number of charge and discharge cycles it can undergo and still be recharged to its near rated capacity (amp-hr). High rated batteries (delivering large current drains for periods of several minutes to 1 hour) have a shorter wet life and cycle life than low or medium rated batteries (discharge at rates from 1 to 10 hours). Under atmospheric conditions the shelf life and cycle life characteristics parallel those shown in Table 7.4.

A great deal of recent battery studies concentrate on silver-zinc cells (11, 12, 13, 14) and provide both laboratory and field data regarding their cyclic longevity. Again, though lead-acid batteries have been used for years, there are no known reports regarding their cycling characteristics in the ocean. Hence, the following data apply only to silver-zinc cells.

In laboratory experiments Funao *et al.* repeatedly cycled two oil-filled batteries (placed in a "soft" container and surrounded by oil) to 600 kg/cm<sup>2</sup> (8,532 psi) and discharged them at 150 amp for 2 hours. Discharge was followed by a 35-amp charge to 2.05 volts and every 10 cycles the battery was discharged to 1.0 volt and measured. A comparison of the data between the pressurized battery and a similar battery not subject to pressure (Fig. 7.5) shows that discharging under pressure delays the rate of capacity decrease. The cause of expiration was short circuits through the separators of both batteries. Work (11) reached similar conclusions after cycling identical ten-cell 250-amp-hr batteries for 2 years in simulated deep-ocean conditions. He found the rate of capacity loss to be the same as that of a similar battery operation at atmospheric pressure for the same period. Momsen and Clerici (13) reported the results of silver-zinc cell use on the Deep Submergence Vehicle *TRIESTE II* and concluded that this type of battery is entirely suitable so long as usage is maximum.

### Charging

Extensive testing demonstrated that charge reception is reduced slightly when silver-zinc battery temperatures are at 32°F or less (13). Whereas charging (and discharging) are heat generating processes, the low

heat transfer coefficient for the cells tends to keep them warm. Work (14) discussed heat transfer within batteries and pointed out that a number of cells packed tightly together can dissipate little heat. Rapid cycling causes the temperature of the center cells to rise appreciably above that of the outside cells and results in an unbalanced condition. To rebalance the batteries two approaches are taken: 1) The entire battery is charged and then floated at a low rate for a few days, or 2) individual cells are charged or discharged at a low rate through the voltage monitor system harness.

### Spill Angle

The normal orientation of wet cell batteries is upright; most are equipped with spill-proof devices and can withstand up to 30-degree tilting without ill effects. Work (14) reported that cells are under design with angles of 45 to 60 degrees from the vertical as a goal. The same report relates an incident where a surfaced vehicle rolled as much as 90 degrees. A 90-degree roll is, to say the least, quite unusual, and one might find it more advisable to reconsider the vehicle's stability rather than designing batteries to withstand roll angles of this magnitude.

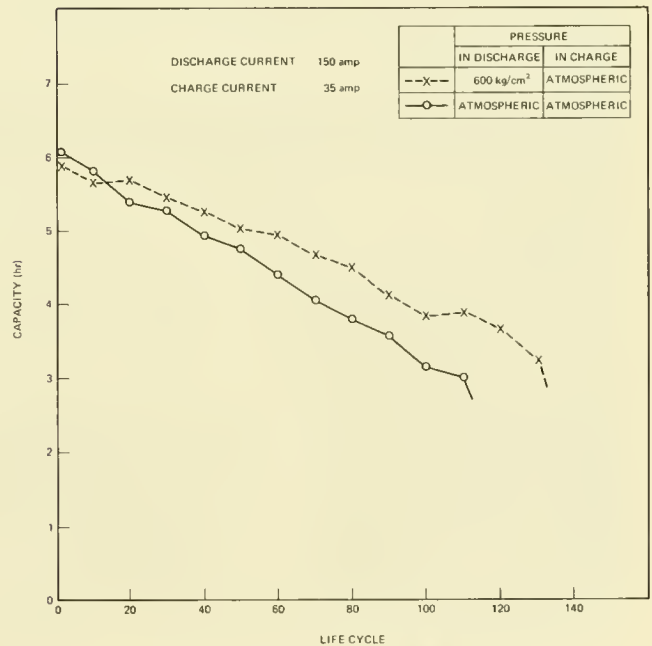

Fig. 7.5 Life characteristics of silver-zinc cell. [From Ref. (12)]

## Gassing

Hydrogen and oxygen gasses are given off from lead-acid batteries during both charging and discharging, though the greatest quantity emanates during charging. The problems brought about by gassing depend upon the packaging and location of the battery. If the battery is carried within the pressure hull the problem concerns the direct effects on occupants due to: 1) Inhalation of hydrogen, 2) explosion of hydrogen or 3) inhalation of chlorine gas if the electrolyte spills and comes in contact with seawater. Silver-zinc cells also evolve hydrogen and, according to Work (14), a "hot" short (where the reaction is sufficiently vigorous to boil the electrolyte) can vaporize mercury, which is used in small amounts in these cells, to present another potential hazard to the occupants. Batteries located externally and pressure compensated by oil avoid the direct safety hazards of poisonous gasses, but introduce other factors bearing on short circuits and ballasting control. The effects of gassing on pressure-compensated batteries

will be discussed in the section on Protection and Pressure Compensation.

An atmosphere containing as little as 4 percent hydrogen ( $69 \text{ in.}^3$  hydrogen/ $\text{ft}^3$  air) is explosive in the presence of a spark or flame. Generally, concentrations greater than 2 percent are avoided for operational safety. Hydrogen is generated in greatest amounts during charging, and for this reason, the charging area should be well ventilated. Being lighter than air, the hydrogen rises and may become trapped in any dome-like space above the battery. Even when idle, a lead-acid battery liberates small amounts of hydrogen, and if in a small confined space, a dangerous accumulation can be reached within a few hours. Another area of hydrogen accumulation can be the void space above the electrolyte within the battery. (According to the Hydro-Catylator Corporation, 1 amp-hr of overcharging, under normal conditions, produces  $25.5 \text{ in.}^3$  of hydrogen per cell, and when idle, it can be assumed that local action will be equivalent to an overcharge flow of 0.1 amp for each 100 amp-hr of cell capacity.)

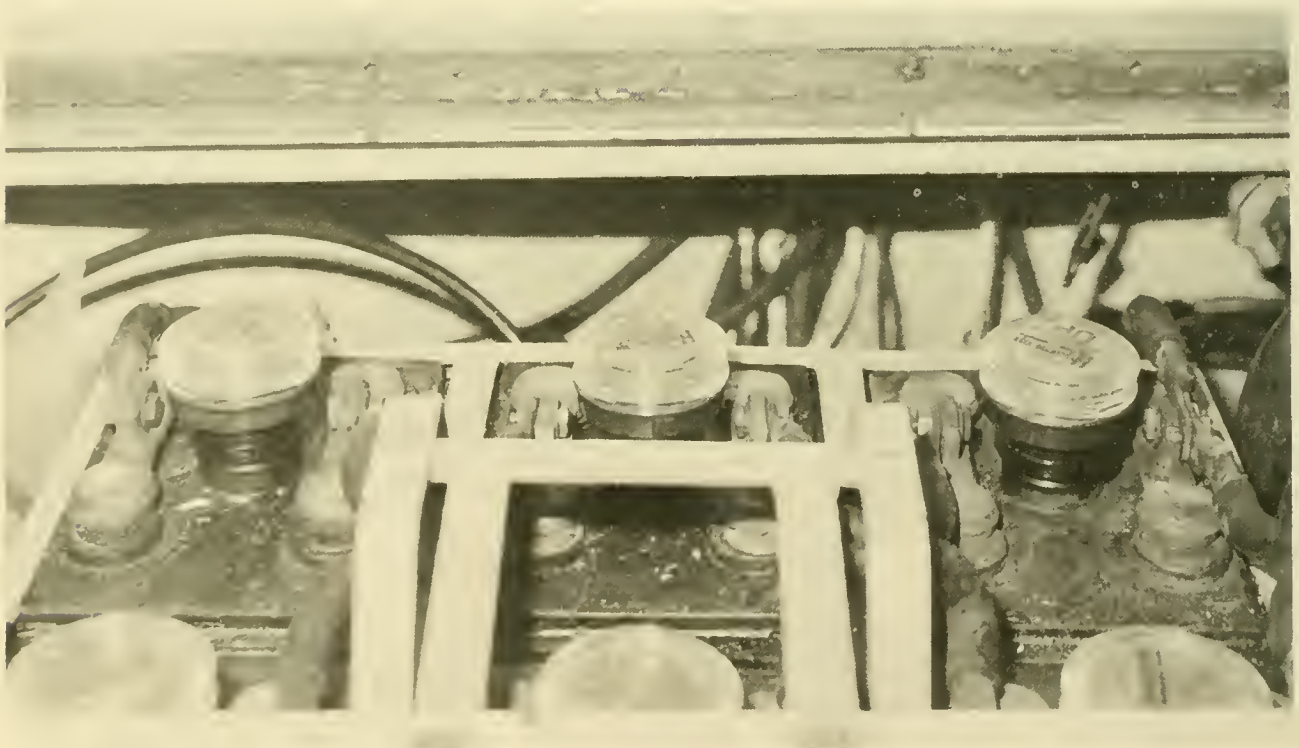

Fig 76 Hydrocaps on SEA OTTER's lead-acid batteries

Submersibles with batteries inside the pressure hull have operated for many years with no ill effects on the occupants; indeed, military submariners have over a half-century of experience in this field with no ill effects. So, for all practical purposes, empirical data shows that accumulation of hydrogen during an 8- to 12-hour dive, or even longer, does not reach quantities detrimental to occupants. Explosions during charging are not infrequent and represent the greatest gassing hazards. Recently a device called a "Hydrocap" has been introduced by the Hydro-Catylator Corporation of Hialeah, Florida. The Hydrocap (Figs. 7.6 and 7.7) is used in place of a conventional battery vent cap, and it contains a palladium catalyst which recombines the hydrogen and ambient oxygen into water vapor which is condensed and returned to the battery. Use of these caps

during charge and discharge is a significant deterrent to hydrogen explosions and also aids maintenance by automatically "topping off" the cells with the reconstituted water. Several submersible builders have adopted Hydrocaps (Perry Submarine Builders, International Hydrodynamics) and find them to be all that the manufacturer claims.

### Battery Location, Protection and Compensation

Submersible builders elect one of three procedures to protect batteries from the rigors of the deep sea: The majority (48%) place the batteries outside the pressure hull, encapsulate them within a dielectric fluid and subject them to ambient pressure; 32 percent place the batteries inside the pressure hull; and 20 percent enclose the batteries within a pressure-resistant capsule external to the

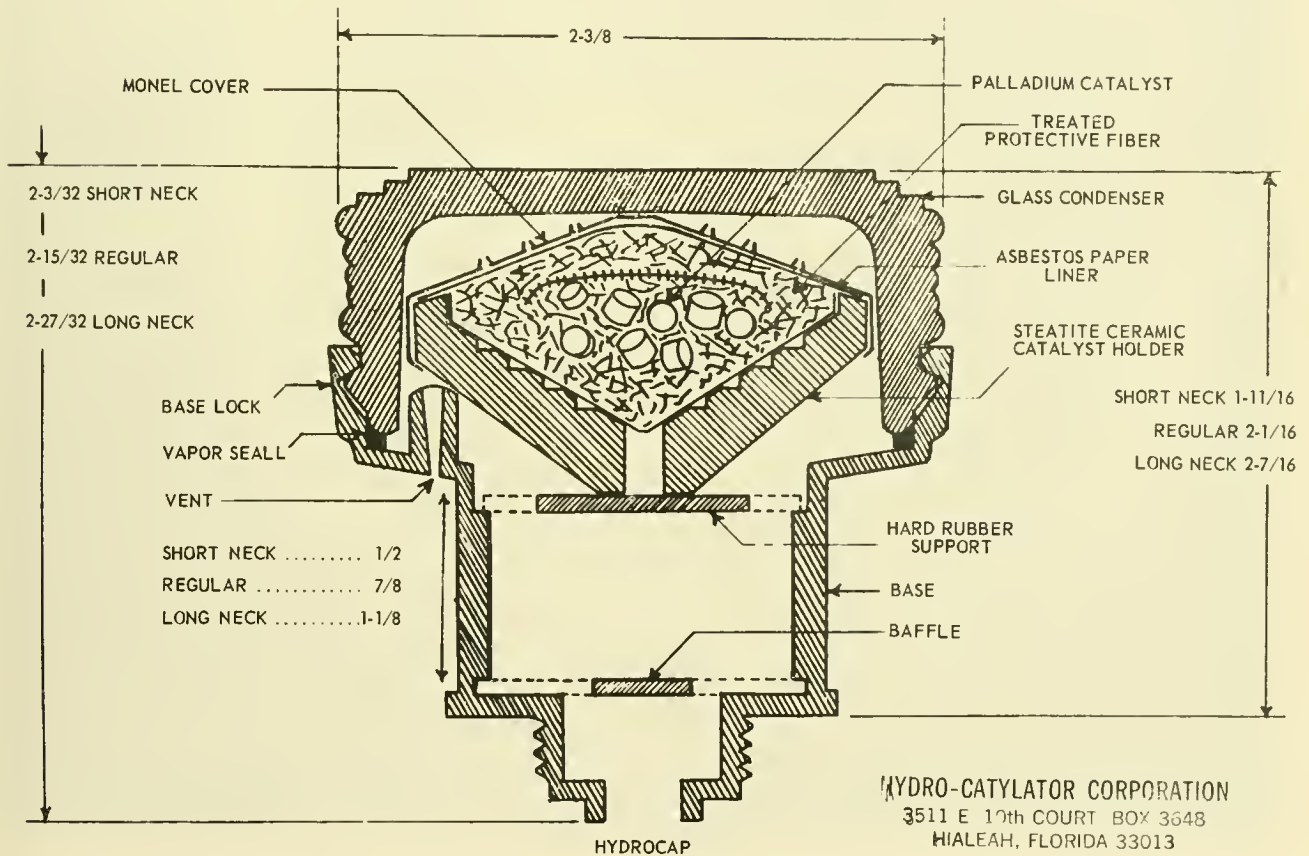

Fig. 7.7 Design of Hydrocaps. (Hydro-Catylator Corp.)

pressure hull. Each approach has its own advantages and disadvantages.

### In-Hull Placement

Placing the battery within the pressure hull reduces circuit complexity, eases maintenance and minimizes the possibility of the cells coming in contact with seawater. Conversely, this option increases the hull weight (and decreases payload), takes up internal space which could be used for equipment or personnel and presents a potential safety hazard to occupants. The first two of these disadvantages are fairly obvious; the safety aspects should be explained. On a short duration dive (8–12 hr) hydrogen gas from discharging batteries, as discussed previously, is not sufficient to harm the human occupants, nor should it reach a concentration (4%) whereby explosion in the event of sparking could occur. Indeed, employment of Hydrocaps should negate either of these possibilities. The first area of concern lies with spillage of the lead-acid electrolyte at high pitch or roll angles. In this case the electrolyte could come in contact with the occupants and cause acid burns or, even worse, it could combine with seawater in the hull and release toxic chlorine gas. It also could damage the submersible structure and equipment therein. Work (14) cautions that a vig-

orous short circuit can boil out the electrolyte in silver-zinc batteries and vaporize the mercury within them to further endanger the occupants. Undoubtedly, the most significant hazard arises during battery charging—and this may occur regardless of battery location—where overcharging might cause electrolyte spillage into the Hydrocap and cause it to cease functioning. In this case hydrogen might build up to dangerous concentration. Anderson *et al.* (15) cites a further consideration in reliance on Hydrocaps; this resides in the possibility that in enclosed spaces insufficient oxygen may be present to recombine with the hydrogen. It should be noted that their discussion relates to the situation where batteries are carried within an external pod, not in the pressure hull where a far greater volume of air is available.

Placement of the battery within the hull has been approached in two ways: The first is to simply install the battery securely in some convenient spot, *e.g.*, **SEA OTTER**, **All Ocean Industries**, and the second is to seal off a portion of the hull, generally low in the hull, and place the battery there (Fig. 7.8). The latter procedure further protects the occupants, and if the sealed area is also pressure resistant it offers additional safety advantages. The in-hull procedure has been

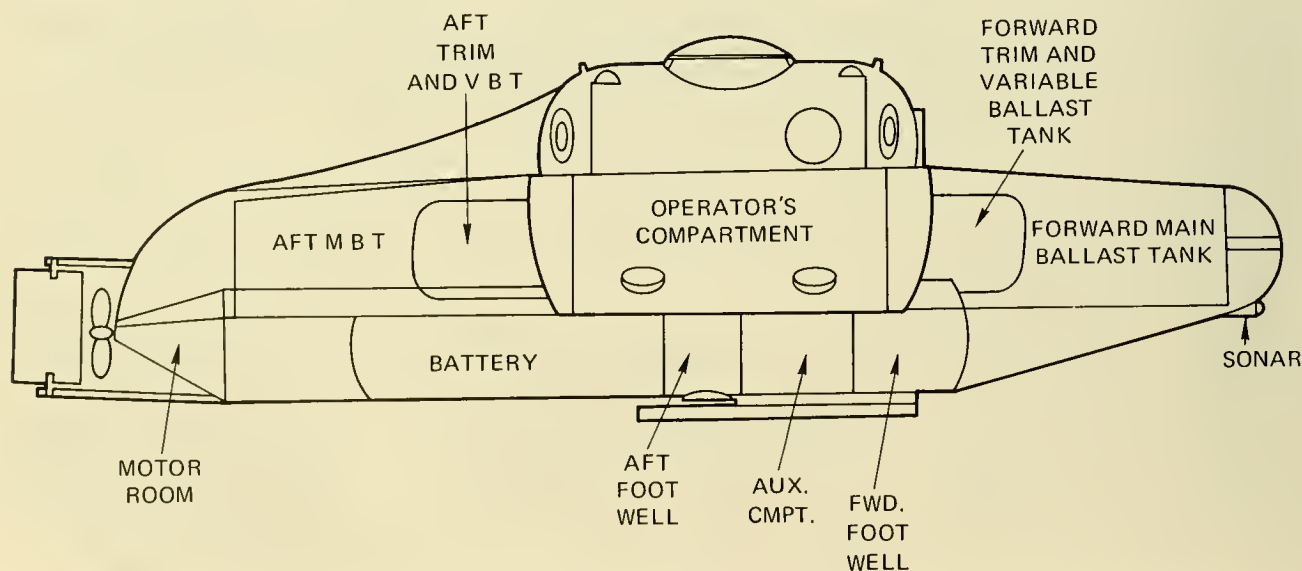

Fig. 7.8 In-hull battery location in the PC-3A. (Perry Submarine Builders)

followed for many years in military submarines and for a number of years in submersibles. It is inexpensive and simple to install and maintain the batteries, and, as long as the proper safety precautions in design and operation are always followed, the only major disadvantages are in degradation of payload and decreased internal volume.

### Pressure-Resistant Capsules

The second option to battery location is installation within a pressure-resistant capsule or pod completely independent of the pressure hull (Fig. 7.9). This procedure, adopted by the majority of latter-day submersible builders, was first initiated by Perry Submarine Builders. Anderson *et al.*

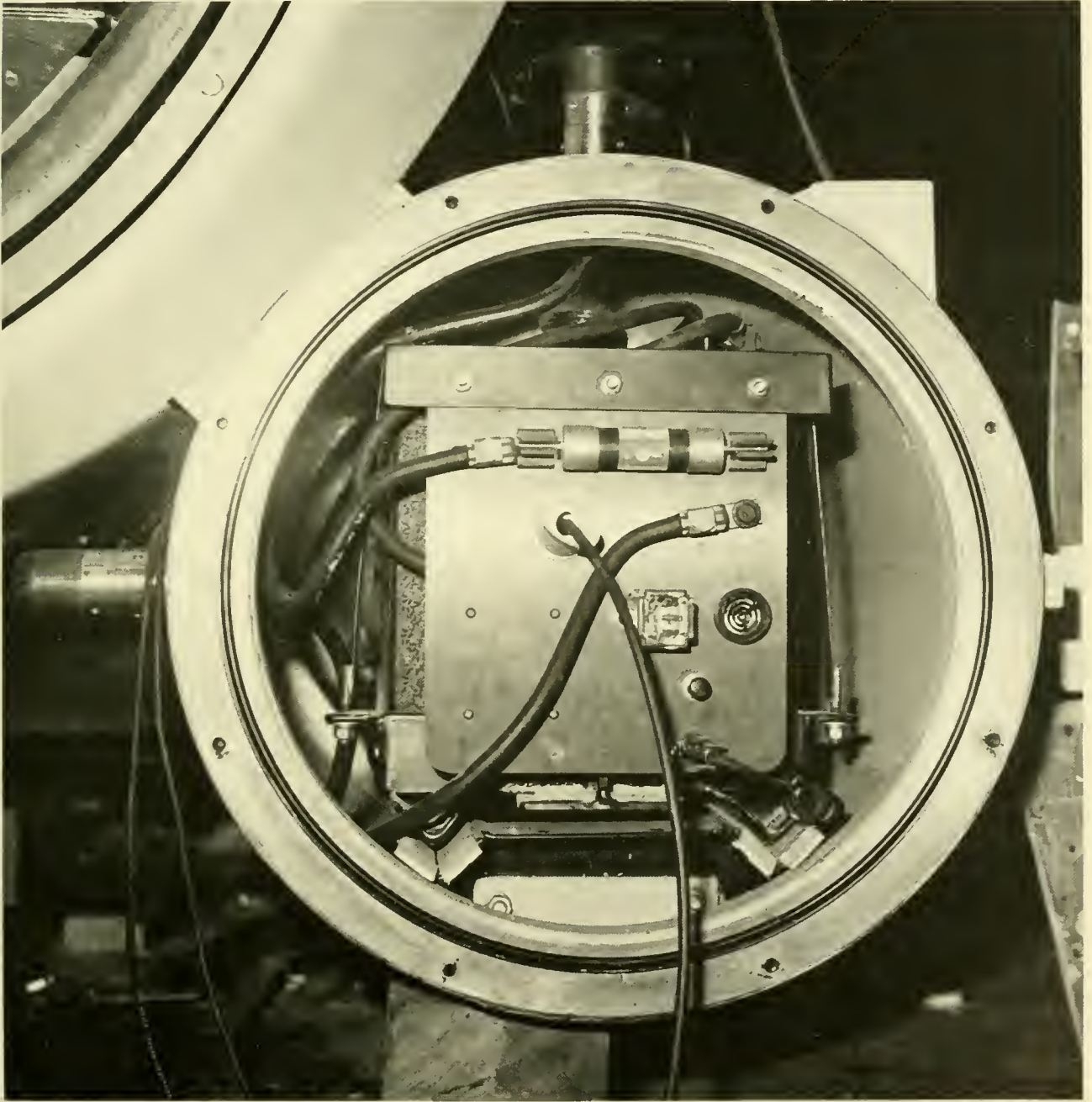

Fig. 7.9 The battery pod of *AQUARIUS I*

(15) present a thorough discussion of the genesis from in-hull placement of batteries to the use of external pods in the Perry submersibles; their observations and experiences constitute the backbone of the following discussion.

Installation of batteries in an external pod offers the following advantages: Internal pressure hull space is not required; any toxic battery gasses which may evolve will not affect the occupants; the pods can be made droppable to serve as emergency deballasting; maintenance and repair is made easier by incorporating roller plates on which the battery may be removed from the pod; the battery tray can be made of a high dielectric material and thereby reduce leakage resistance problems; both ends of the pod can be removed and forced air ventilation applied to dissipate hydrogen gas generated during charging; and for quick turn-around time between dives the used batteries can be easily replaced with fresh ones.

Conversely, this procedure has the following disadvantages: Total vehicle weight is increased; the drag force of the vehicle is increased and thereby requires increased power for propulsion; electrical penetrations for power are increased; and total cost of the vehicle rises.

One problem of major concern in the Perry vehicles is battery gassing during submerged discharge (15) and the lack of sufficient oxygen within the pod to recombine in the Hydrocaps with the hydrogen generated. To alleviate this problem the battery pod on **SHELF DIVER** was pressurized prior to sealing to provide adequate oxygen. To prevent poisoning of the palladium catalyst the Hydrocaps in Perry vehicle pods are located in the top of the pod such that overcharging will not contaminate the catalyst with electrolyte.

This procedure, then, offers a number of advantages and disadvantages, the greatest penalty being weight. Compared to the pressure-compensation system, external pressure-resistant pods are far less trouble and considerably more reliable. There is a point, however, where the added weight would become prohibitive in the deeper diving vehicles.

## Pressure Compensation

In this arrangement the batteries are located outside the pressure hull and within a non-pressure-resistant container. A dielectric fluid (oil) completely surrounds the cells and provides both electrical insulation and pressure equalization. A typical compensation system is shown in Figure 7.10. The system conserves vehicle weight and pressure hull volume, while offering no direct safety hazards to the occupants. In some vehicles the batteries are jettisonable to provide emergency buoyancy. On the debit side, the present systems are messy, generally difficult to maintain, and, according to Work, ". . . *destined to get salt water in them at one time or another.*"

Packaging batteries in this manner must satisfy two, relatively simple requirements: Hold the dielectric fluid in and keep seawater out. While the requirements are sim-

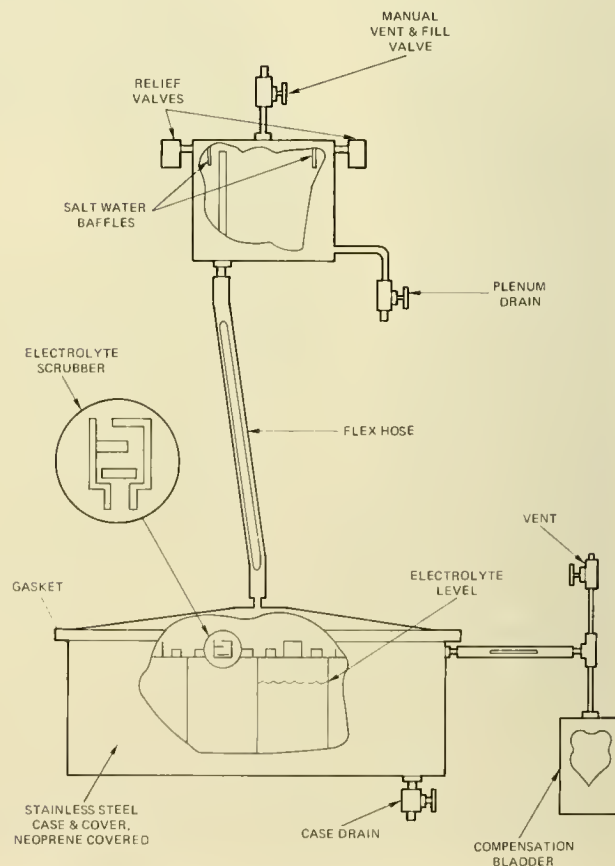

Fig. 7.10 Typical battery compensation system. [From Ref. (16)]



ple, meeting them in practice has consumed a great deal of time and effort. Because oil is used as the pressure compensation medium, all other materials must be oil-compatible. Gasses generated during the batteries' operation must be vented off. As this gas leaves the electrode, it carries entrained electrolyte, and if no provisions are made to separate the two (gas from electrolyte), the electrolyte may accumulate on top of the cells and elsewhere to produce a host of problems. While the gas may be held in solution at great depths, it leaves the cell or comes out of solution as the vehicle surfaces. These are but a few of the problems associated with pressure-compensation systems. A review of the literature makes one wonder that the system works at all. Nonetheless, it somehow does, and the need to conserve weight and space in deep diving vehicles has prompted a great deal of attention to this procedure.

The approach to pressure compensation has been on an individual basis; no two systems are precisely the same and all have their own peculiar problems. Consequently, the subject might best be served by concentrating on the experiences and research of a few, rather than the problems of a multitude. An appreciation for the range through which battery compensation problems can vary from vehicle-to-vehicle can be gained from Figure 7.11.

The gassing behavior of lead-acid batteries under both atmospheric and high (1,000 psi) pressure conditions was studied in detail by Marriott and Capotosto (17 & 18). Specifically they delved into the chemical, physical and electrical properties of the compensating oil used in the *STAR* series of submersibles (Primol 207, a hydrocarbon oil produced by Exxon Oil) and its compatibility with nonmetallic battery components. They also looked into the entire spectrum of bubble genesis during charge and discharge of Exide MSC-11 batteries. The results of this study are summarized by the authors as follows:

*“The volume of gas produced by the subject battery during discharge at elevated pressures is not directly dependent on the magnitude of the applied pressure.*

*The gassing behavior of the MSC-11 cell during discharge under pressure is much more erratic than at atmospheric pressure.*

*A decrease in the gas producing ability of the battery along with a build-up of battery by-products occurs more quickly at pressure than under ambient conditions.*

*Gas volumes entrapped by the battery after discharge at pressure generally vary from 100-155 ml. On occasion,*

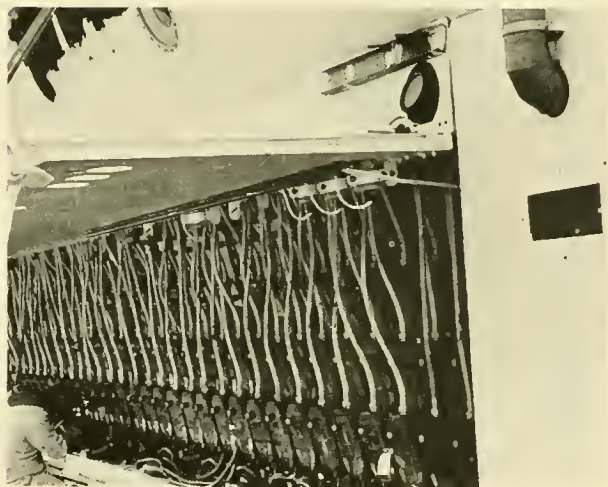
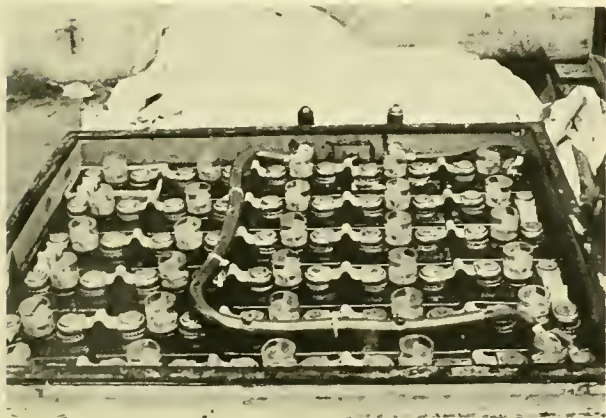

Fig. 7.11 Two pressure compensated systems. *STAR III* (left) of 60 cells and *BELL FRANKLIN* (right) of 378 cells. (Gen. Dyn. Corp. and NAVOCEANO)

*lower values (40 ml) can be obtained.*

*No evidence of degradation of Primol 207 dielectric fluid as a consequence of discharging the battery at pressures up to 1000 psi can be noted."*

In a companion paper R. S. Evans (16) discussed the whole range of pressure compensation considerations based on analyses of the behavior of lead-acid batteries in *ASH-ERAH*, *STAR II* and *STAR III*. Evans' report is succinct and in very few words he presents a wealth of experience the submersible designer would do well to review. Several aspects of batteries and pressure compensation systems, not dealt with elsewhere in this section, are summarized below and are taken directly from Evans.

#### Vehicle Dynamics:

List, trim and attack angles and angular rates affect such parameters as acid and oil movement, structural fatigue and distortion. Relative to a surface craft, a surfaced submersible is more vulnerable to sea forces which produce bending and impact loads in components of the pressure compensation system and battery containers.

In a rapid emergency ascent (300 to 600 fpm) the gasses entrained or in solution might rupture the system or accumulate to a potentially explosive volume. Introduction of sufficient seawater via a rupture invites certain explosion or rapid combustion of oil and gas.

A series of relatively shallow dives and quick ascents will cause compensating oil to push out of the vents in front of the expanding gas which is produced continuously. If the bladder design cannot accommodate such losses, insufficient compensation volume may result on an ensuing deep dive with possible leakage into or destruction of the batteries.

#### Pressure:

Interior system pressure should be kept slightly positive with respect to ambient. In this vein Evans offers the following precautions in selection of materials for sea pressure service: Battery lead deforms plastically; bulk moduli of adjoining materials should be as nearly equal as possible for in-cell connection and wedging.

#### Biological:

Evans relates the following experience with respect to biological considerations:

*"STAR III was so busy in 1966-67 that over one year passed before the battery box interiors were inspected. When they were finally opened, a film of biological material was discovered deposited across the cell tops. The organism was cultured and tentatively identified as Pullularia pullulens, a black, yeast-like mold. The system had been anaerobic for the period, yet this organism apparently thrived and declined several times in this supposedly hostile environment. If the ecology were not controlled by additive inhibitors or occasional flushing with anti-septics, it is conceivable that organisms could flower under the proper conditions and cause short circuits by entrapping water and/or acid, or could clog lines and valves with their detritus. Such a case was reported by TRIESTE which had an open sea/oil interface compensator at the time. Of course, any additive or purgative would first have to be proved materials compatible."*

Utilizing this and other information gained over several years' experience with the *STAR* class vehicles, Evans and co-worker B. B. Miron proceeded to draw up the design specifications for pressure compensation of the *SEA CLIFF* and *TURTLE* battery pods (19).

The best compensating fluid for battery systems has been particularly difficult to define. According to Work (11), "The ideal compensating fluid is non-reactive, non-compressible, and probably non-existent." In an attempt to solve this dilemma, the Naval Ship Research and Development Center (NSRDC) performed an assessment of applicable experience with such fluids and tests of their own to issue a guide (20) providing critical properties, evaluation methods and other pertinent fluid and lubricant information to the workers in deep submergence.

NSRDC not only dealt with fluids for compensation and shielding from the seawater environments, but also looked at fluids for

hydraulic systems (power transmission) and lubrication for deep submergence application. A variety of fluid properties were investigated in these tests: Viscosity (temperature and pressure effects on), lubricating ability, effects of contamination, corrosion protection, dielectric properties, dissipation factor, ability to form stable emulsions, material compatibility, volatility and toxicity, compressibility and density, chemical stability, fire resistance and cost and availability. From these tests and other sources Table 7.5 was derived which provides a ready reference for assessing the applicability of a particular fluid in deep submergence applications. The NSRDC authors caution that a listing of P after a fluid does not constitute endorsement for use, nor does Q constitute condemnation.

## FUEL CELLS

In 1965 General Dynamics installed and tested an Allis-Chalmers fuel cell in its *STAR I* (Fig. 7.12). A schematic of the fuel cell used in *STAR I* is shown in Figure 7.13 and according to reference (21) it works in the following manner. The basic construction consists of two electrodes separated by an electrolyte (potassium hydroxide). A hydrazine fuel is admitted to the anode electrode, where it reduces hydroxyl ions in water and releases electrons. The electrons flow through the external circuit to the other electrode (the cathode), where the oxidant is admitted. The electrons are used in the oxidant's reaction with water to form hydroxyl ions. Ionic conduction through the electrolyte completes the electrical circuit and pro-

TABLE 7.5. IDENTIFICATION OF FLUID CODES

Fluid Code	Commercial Name	Supplier
A	PR-1192	E. F. Houghton Co., 303 W. Lehigh Ave., Philadelphia, Pa. 19133
B	Micronic 713	Bray Oil Co., 3344 Medford St., Los Angeles, Calif. 90063
C	Micronic 762	Bray Oil Co., 3344 Medford St., Los Angeles, Calif. 90063
D	NDH-TD4-1	New Depatture — Hyatt Bearings, Hayes Ave., Sandusky, Ohio 44871
E	Hoover Submersible Fluid No. 2	Hoover Electric Co., 2100 South Stoner St., Los Angeles, Calif. 90025
F	Tellus 11	Shell Oil Co., 50 W. 50th St., New York, N.Y. 10020
G	Tellus 15	Shell Oil Co., 50 W. 50th St., New York, N.Y. 10020
H	Tellus 27	Shell Oil Co., 50 W. 50th St., New York, N.Y. 10020
J	Primol 207	Humble Oil and Refining Co., P.O. Box 1288, Baltimore, Md. 21203
K	Marcol 52	Humble Oil and Refining Co., P.O. Box 1288, Baltimore, Md. 21203
L	SF-1143	General Electric Co., Silicone Products Dept., Waterford, N.Y. 12188
M	C-141	Royal Lubricants Co., River Road, Hanover, N.J. 07936
N	PR-85-29-129	E. F. Houghton Co., 303 W. Lehigh Ave., Philadelphia, Pa. 19133

TABLE 7.5 SUMMARY LIST OF FLUIDS AND LUBRICANTS [FROM REF. (20)]

Specification or Trade Name	Other Designation	Base Fluid Composition	Application				Nonmoving Electrical Equipment Immersion	
			Power Transmission	Lubrication	Motor Immersion	Switching Component Immersion		
Federal Specification Products								
VV-I-530a	Transformer Oil	Petroleum	---	---	Q	KP	KP	
VV-D-001078(10 cs)	Damping Fluid	Silicone	Q	Q	KQ	KQ	KP	
VV-D-001078(50 cs)	Damping Fluid	Silicone	KQ	Q	Q	Q	Q	
Military Specification Products								
MIL-H-5606B	Aircraft Hydraulic Fluid	Petroleum	KP	KP	KP	P	P	
MIL-J-5624F	JP-5	Petroleum	---	KQ	KQ	Q	Q	
MIL-L-6081C, Grade 1010	Jet Engine Lubricating Oil	Petroleum	KQ	KQ	KQ	KQ	Q	
MIL-H-6083C	Aircraft Hydraulic System Preservative	Petroleum	K	KQ	KQ	KQ	KQ	
MIL-L-6085A	Aircraft Instrument Oil	Synthetic	KQ	KQ	KQ	Q	Q	
MIL-L-7808G	Gas Turbine Lubricating Oil	Synthetic	---	KQ	Q	Q	Q	
MIL-L-7807A	Low Temperature Lubricating Oil	Petroleum	---	K	Q	Q	Q	
MIL-C-8188C	Gas Turbine Engine Preservative	Synthetic	KQ	KQ	Q	Q	Q	
MIL-F-17111	Ordnance Hydraulic Fluid	Petroleum	Q	P	---	---	P	
MIL-L-17672, MS 2110-TH	Turbine Oil and Hydraulic Fluid	Petroleum	KQ	KQ	Q	Q	P	
MIL-S-21568A	Damping Fluid	Silicone	Q	Q	KQ	KP	KP	
MIL-L-23699A	Aircraft Turboprop and Turboshaft Lubricant	Synthetic	---	KQ	---	---	---	
MIL-H-27601A	Aircraft High Temperature Hydraulic Fluid	Petroleum	---	---	---	---	---	
MIL-H-46004	Missile Hydraulic Fluid	Petroleum	KQ	---	---	---	---	
MIL-H-81019B	Aircraft and Missile Hydraulic Fluid	Petroleum	P	Q	---	---	P	
MIL-H-83282	Aircraft Hydraulic Fluid	Synthetic	---	---	---	---	---	
Proprietary Fluids								
Fluid Code A	Seawater Emulsifying Fluid, Type I	Petroleum	KQ	KQ	Q	Q	Q	
Fluid Code B	---	Petroleum	KP	KQ	Q	Q	Q	
Fluid Code C	Proposed Specification MIL-H-25598 Missile Hydraulic Fluid	Petroleum	KP	KQ	Q	Q	Q	
Fluid Code D	Traction Drive Fluid	Petroleum	---	---	---	---	---	
Fluid Code E	---	Petroleum	---	KQ	KQ	---	P	
Fluid Code F	---	Petroleum	P	P	---	---	P	
Fluid Code G	---	Petroleum	P	P	---	---	P	
Fluid Code H	---	Petroleum	P	P	---	---	---	
Fluid Code J	USP Mineral Oil	Petroleum	---	Q	KQ	KQ	KP	
Fluid Code K	NF Mineral Oil	Petroleum	---	Q	---	---	---	
Fluid Code L	Lubricity Improved Silicone	Silicone	Q	Q	KQ	KP	KP	
Fluid Code M	---	Petroleum	---	P	Q	Q	Q	
Fluid Code N	Seawater Compatible Water Glycol	Water	---	Q	Q	Q	Q	
P - Possible use		Q	- Questionable for use in this application					
K - Known or attempted use		---	-(blank) - Insufficient information available for assessment of use					

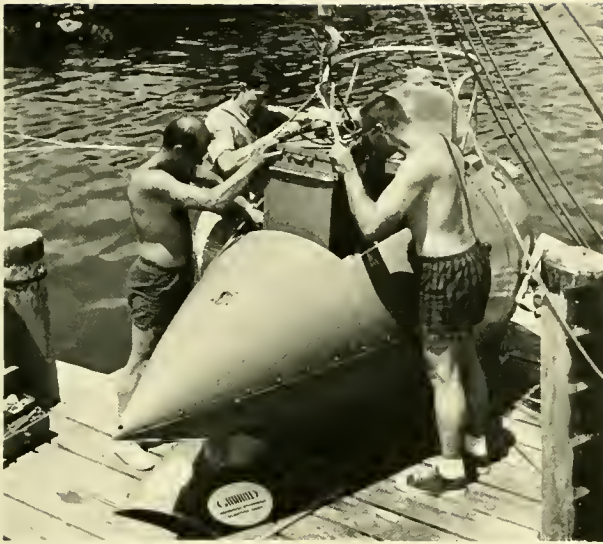

Fig. 7.12 Installing hydrazine and oxygen fuel cell in *STAR I*. (Gen. Dyn. Corp.)

duces the usable electrical energy. The fuel cell is an electrochemical device converting energy from the reaction of two chemicals into low voltage, DC electrical energy. Whereas a battery's energy is stored, a fuel

cell will produce current on demand as long as the fuel and oxidizer are supplied.

The fuel cell in *STAR I* is pressure-compensated, not by oil, but by the nitrogen gas released when the hydrazine fuel is consumed.

The authors, Loughman and Butenkoff, cite the following advantages to fuel cells: Turn-around time is minimal, in that only the refurbishing of fuel and oxidant is required; they are lighter than comparable power-producing batteries and do not take up as much space; they have longer life than conventional underwater power sources; they may be tapped at any voltage and not affect cell life; and they are silent and operate at relatively low temperatures. Other than this one report (21), nothing further has been heard from this program.

In November 1969, the Perry company entered a fuel cell test program with Pratt & Whitney Corp. which resulted in the installation of an oxygen/hydrogen fuel cell in the underwater habitat *HYDRO-LAB* situated in 50 feet of water off Palm Beach, Florida (22). While this application is outside the subject

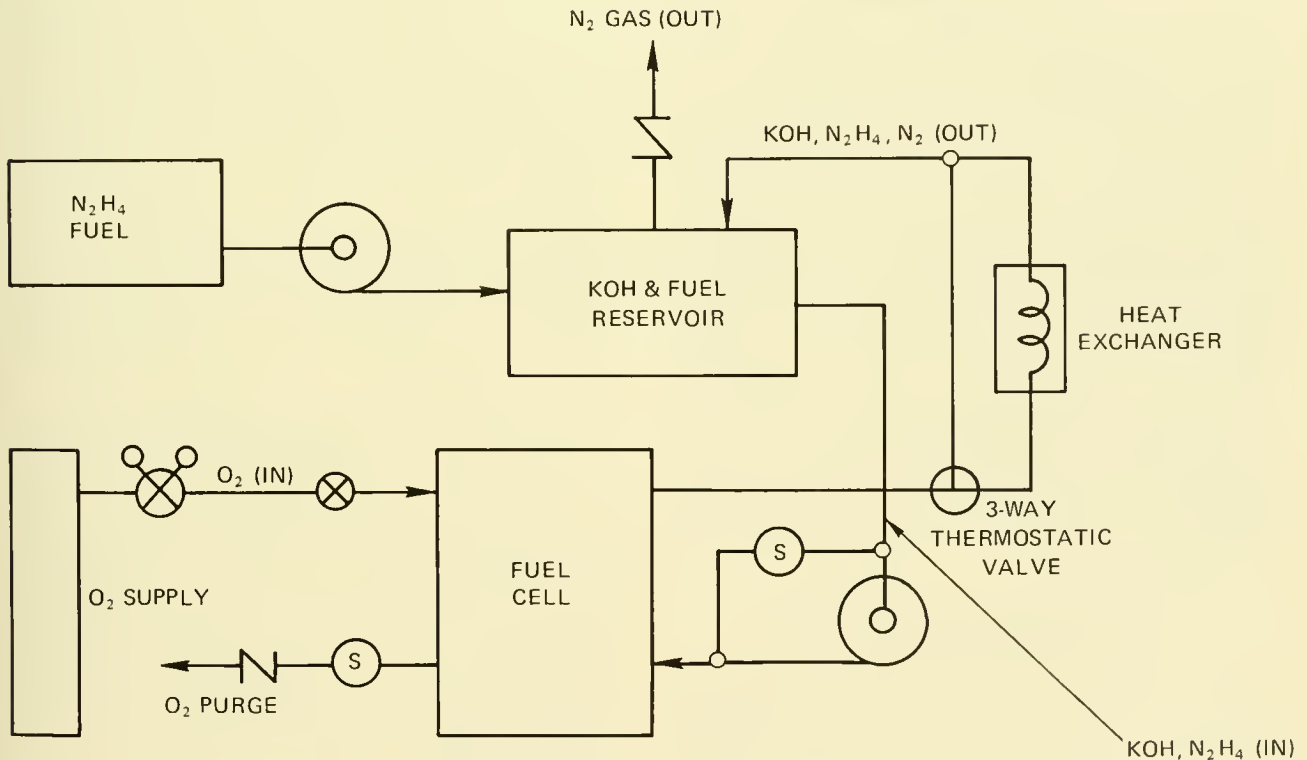

Fig. 7.13 Schematic of *STAR I* fuel cell. [From Ref. (21)]

of manned submersibles, it was, according to the author, the first such application in a habitat and supplied 5 kilowatts at 28 VDC for a period of 48 hours and with no malfunctions. This report's final statement rather succinctly states the major problem with fuel cells: "A reduction in cost is required before extensive use becomes a reality."

The latest attempt at utilizing fuel cells in submersibles was conducted off Marseilles in May 1970 with a hydrazine-hydrogen peroxide generator in the *SP-350* (23). Several tests of this fuel cell were conducted in 265 feet of water during a series of dives of not more than 15 minutes in length. The investigators concluded that the tests were successful and indicated that the fuel cell is not only a theoretical possibility, but a practicality in submersible operations.

For those interested in the potential and technological state-of-the-art of fuel cells for deep submergence application references (5), (24), (25), (26), and (27) are recommended. The last two of these include a discussion of nuclear and other power sources, as well as fuel cells.

## NUCLEAR POWER

The U.S Navy's *NR-1* is the only submersible known to use a nuclear reactor as an electric power source. Since *NR-1*'s details are classified, one can only speculate about it. On the other hand, while nuclear power has revolutionized the military submarine, its past, present and proximate influence on submersible design is likely to be minimal. The reason is quite simple; *NR-1* costs in the neighborhood of \$100 million; even the most optimistic advocates of deep submergence would find it difficult to justify such an expenditure for a commercial venture. Again the reader is referred to references (5), (26), and (27) for an account of nuclear power potential and application to other areas of marine technology.

## CABLE-TO-SURFACE (UMBILICAL)

Three submersibles obtain electrical power through a cable from the surface: *KURO-*

*SHIO II*, *GUPPY* and *OPSUB*. The pros and cons of this approach are many and will not be explored in detail here. It is sufficient to note that in the case of *GUPPY*, the reasoning which led to an umbilical included: Launch/retrieval would require no divers and the projected customer (offshore oil) would require more in the way of electrical power than batteries or fuel cells could supply within the dimensional constraints of the preconceived vehicle (28). An additional consideration was based on *KUROSHIO*'s and the unmanned *CURV*'s history of successful tethered operations—*i.e.*, they provided proven techniques.

A few submersibles, *SEA RANGER* in particular, include an umbilical option by providing an external electrical attachment. The option has a great deal of merit if tasks are required where long-term, stationary observations are planned, such as may happen in some biological or sedimentological studies. The design, construction and operation of a tethered power supply is discussed fully in the literature. For a thorough and excellent summary of the subject, the work of Evo Giorgi (27) is recommended.

The umbilical system is basically quite simple (Fig. 7.14) and consists of a generator, winch and a load-bearing, conducting cable. In the *GUPPY* operation, the surface generator sends 35 kW at 440 VAC down the insulated and strengthened cable to the vehicle. Since power coming to the submersible is already AC, no on-board converters are needed, with consequent weight and volume savings. Buoys are attached at intervals along the cable to keep it from fouling the vehicle and adding to the propulsion load. The cable also serves as a hard line underwater telephone.

The *KUROSHIO II* system—essentially similar to that of *GUPPY*—sends 400 VAC to the submersible where a transformer within the pressure hull supplies 100 V to the vehicle's instruments. Specifications for *KUROSHIO II*'s generator and cable are presented in Tables 7.6 and 7.7, respectively. The cable winch is driven by a 10-hp, AC motor and consists of a controller, reduction gear, reel and winding drum mounted on a common platform (29).

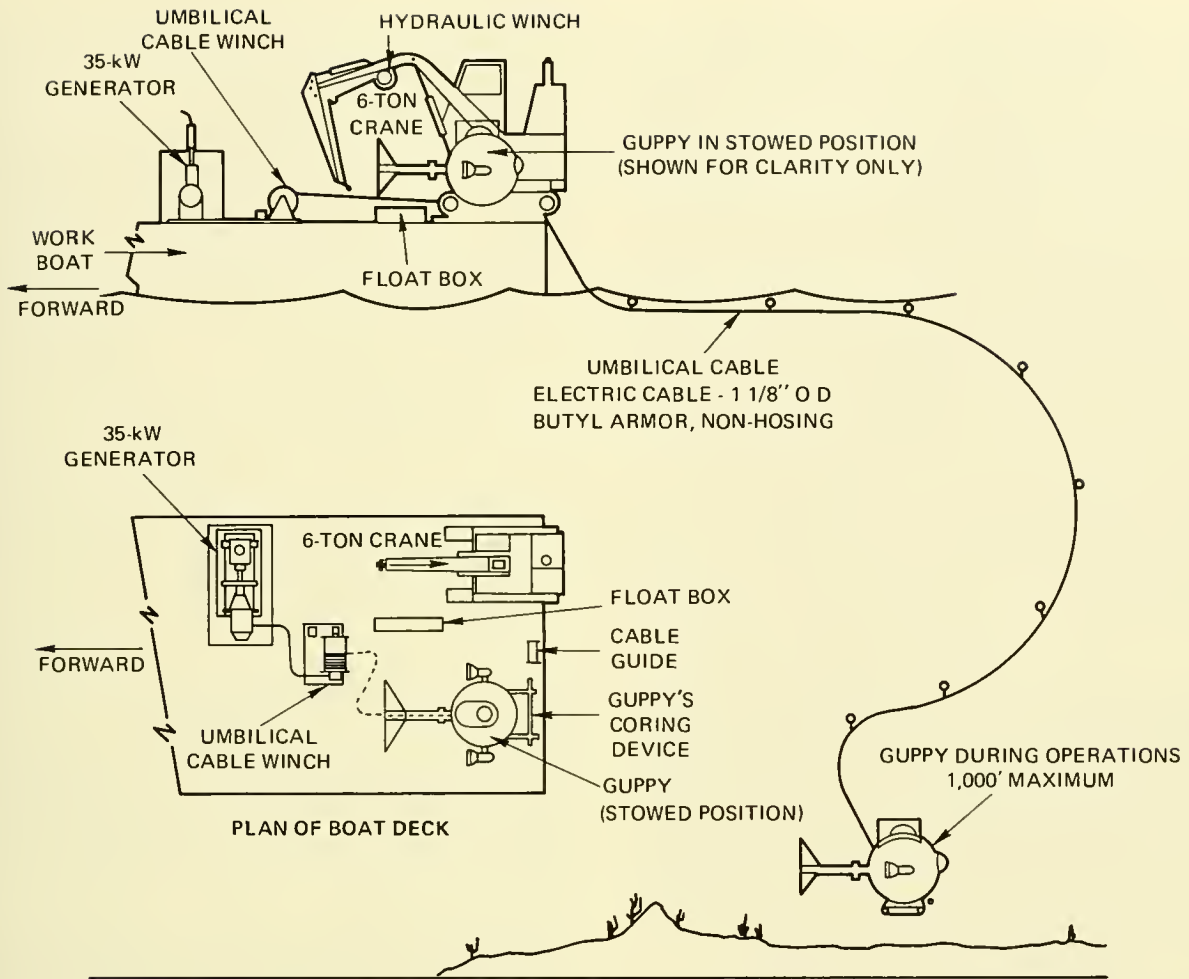

Fig. 7.14 GUPPY's operational system. (W. Watson, Sun Shipbuilding and Dry Dock)

TABLE 7.6 SPECIFICATION OF AC GENERATOR AND PRIME MOTOR OF KUROSHIO [FROM REF. (29)]

AC Generator		Prime Mover	
Type: Totally-Enclosed		Type: 4-Cycle Single-Acting Diesel Engine	
Output	25 KVA	Output	30 hp
Revolution	900 rpm	Revolution	900 rpm
Rating Continuous			
Voltage AC	470 V		
Frequency	60 cps		

TABLE 7.7 THE SPECIFICATION OF THE POWER CABLE OF KUROSHIO [FROM REF. (29)]

Item Type	Power 3-Core	Telephone 1 Circuit	Selsyn 2 Circuits		Coaxial
Number of cores	3	2	2	3	1
Nominal sectional area (mm <sup>2</sup> )	14	1.25	0.75	0.75	—
Outside diameter (Approx.) (mm)	8.4	8.5	8.4	8.5	8.5
Outside diameter of tension meter (Approx.) (mm)		9			
Finished outside diameter (Approx.) (mm)		36			
Weight in the air (Approx.) (kg)		2.05			
Weight in the water (Approx.) (kg)	0.75 (Note: Buoys are attached in actual use)				
Length (m)		600			

From a safety viewpoint, the cable may be either friend or foe. In the event of the vehicle fouling or the loss of surfacing ability, the cable can be used as a retrieval line. Conversely, if the cable fouls, provisions are made in *KUROSHIO II* for the occupants to release the cable directly from the hull.

## DIESEL-ELECTRIC

To reduce the dependency on surface support, several submersibles incorporate diesel engines in their power inventory for surface propulsion (Table 7.1) and, in a few, to recharge depleted batteries after a dive. In essence, they follow procedures quite similar to those of conventional battery-powered military submarines. The French submersible *ARGYRONETE*, had it been completed, would have operated identically to a military submarine in that its diesel motors would have provided full autonomy for surface cruising and battery charging, while lead-acid batteries would have supplied submerged power.

The submersibles now in existence use their diesel-electric motors not so much for long-range surface transits as for charging batteries or powering an air compressor to refill depleted air tanks. The following descriptions relate the surface power and details available for the vehicles *SUBMANAUT*

and *TOURS 66*. In *GOLDFISH* a Ford V-8 engine supplies power for direct drive on the surface and is coupled to a 6.4-kW generator (200 amp at 32 V) for battery charging and for compressor operation in recharging of air tanks.

### *SUBMANAUT*:

Martine's *SUBMANAUT* realizes surface propulsion from a fresh water cooled, General Motors 6-cylinder diesel engine (Model 6-71) which develops approximately 235 hp. Surface cruising speed is 10 knots and the on-board diesel fuel (300 gal) allows a range of 2,000 nautical miles. A 5-kW generator is belted to the forward end of the diesel engine and is used to recharge the vehicle's batteries. Approximately 2 hours of charging time are required to balance 1 hour of discharge time (45 amp at 150 V). A 3,000 psi air compressor is also belt driven off the diesel engine and supplies 12 cfm.

### *TOURS 66*: (Fig. 7.15)

A 28-hp, 3,000-rpm diesel generator is arranged aft in the pressure hull to form an extension of the battery room deck. All pipelines connected with the diesel engine (exhaust gas, fuel, and cooling water) are provided with compensators. A water-cooled exhaust gas silencer is arranged behind the exhaust gas collecting elbow of the diesel engine. Exhaust gasses are led through an



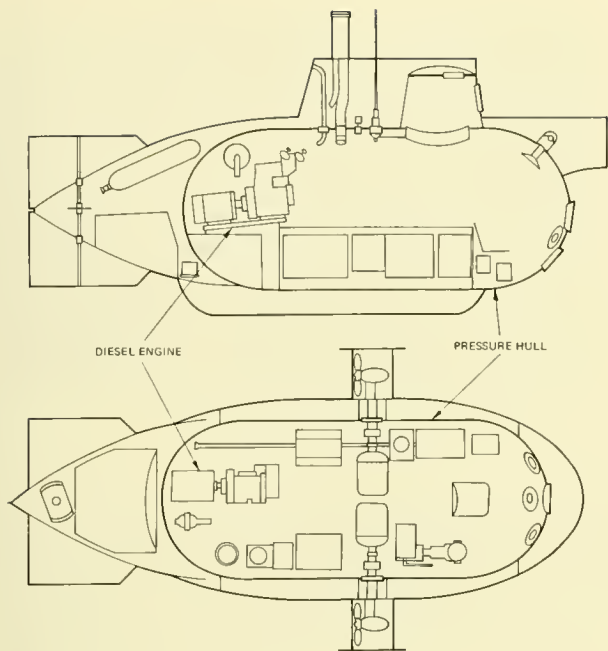

Fig. 7.15 TOURS 66 diesel engine layout.

exhaust gas line to outboard. The diesel engine is equipped with decompression equipment and complies with the regulations of Germanischer Lloyds.

The engine is cooled through a seawater-freshwater twin circulation system incorporating both seawater and freshwater pumps. The diesel fuel tank is within the exostructure. The fuel ( $0.47 \text{ m}^3$ ) is delivered by means of the fuel pump attached to the diesel engine through a fuel tapping dome. Compensation for used diesel fuel is effected by means of the vehicle's trim tanks. A surface cruising range of 400 nautical miles at 5 knots is possible. The diesel engine drives a DC shunt-wound generator, which is self-ventilated, and supplies 15 kW of charging power for the main battery at 3,000 rpm, with a voltage range between 250 and 290 and a maximum charging current of about 60 amp. Central ventilation is provided for the battery room. The air is sucked by the battery-room fan from forward to aft over the cells. During surface operation the air is passed to outside via the exhaust air mast.

The present use of diesel engines in submersibles (only in surface operations) avoids

a great number of the problems that would be encountered in closed-cycle diesel power systems supplying submerged power (see refs. 5 and 26). Nonetheless, Sub Sea Oil Services of Milan is presently conducting a research and development program which it hopes will result in a system capable of both extended surface cruising and closed-cycle underwater operation for **PHOENIX 66**.

The results of a program at Aerojet-General, Azusa, California, in 1970 have direct application to closed-cycle diesel power systems and warrant the attention of present and future submersible power design engineers. Commencing as an in-house research and development program, the Aerojet power system called "Psychrodiesel" received additional funds from the U.S. Air Force to develop a breadboard model and conduct demonstrations of a prototype closed-circuit power system.

Psychrodiesel operates on a principle Aerojet called "Psychrocycle," in which the diesel engine "breathes" a mixture of oxygen gas and water vapor in place of air. This synthetic air combusts with diesel fuel to provide an exhaust consisting only of water vapor, carbon dioxide and unconsumed oxygen. The steam (water vapor) is condensed, the carbon dioxide chemically absorbed and the oxygen recycled to complete an operating closed cycle. Thus, the complete system is fully enclosed during an undersea operation.

In a detailed discussion of the history, development, and operation of the Psychrodiesel, Hoffman *et al.* (30) compare its efficiency with other closed-cycle systems, *e.g.*, Rankine, Stirling, and Brayton, and speculate that the internal combustion engine may achieve higher thermal efficiency than the Stirling because its maximum cycle temperature is nearly double. Of particular interest is their design of a Psychrodiesel system (both closed-cycle and air breathing) for small and large submersibles which could supply power for propulsion and hotel loads. The small submersible Psychrodiesel package is 4 feet in diameter by 6 feet in length and delivers 60 kWh submerged. The large system configuration constitutes a module 4 feet in diameter by 20 feet in length, totaling 16,000 pounds and delivering 1,000 kWh sub-

merged and 2,000 kWh surfaced. Both designs are shown in Figure 7.16.

## POWER DISTRIBUTION

Few submersible components receive more attention than the penetrators, cables and connectors used to distribute electric power. The reason is clearly evident when the performance of submersibles is reviewed: These components range in reliability from marginal to deplorable. One might wonder why this inadequacy was not discovered in the near half-century of military diving before the advent of the manned submersible. The answer, in part, resides in the large size of fleet submarines relative to submersibles. A military submarine carries its power and propulsion machinery within the hull, and except for sonar devices, communication antennae and depth sensors, very little else penetrates the hull. More importantly, the WWII submarine, except in emergency, dived no deeper than about 300 feet; at this depth the requirements for a successful penetrator are considerably relaxed. From an electrical point of view, a manned submersible is a submarine turned inside out. Indeed, in some vehicles the majority of electrical hardware is external to the pressure hull and subject to every transgression in the deep-ocean's arsenal.

One of the most beneficial aspects of the DSSRG Report to both the military and civilian submersible builders was the illumination of problems associated with power distribution and the steps taken to identify, categorize and remedy these problems. One of these steps was establishment of the Deep Ocean Technology (DOT) program in 1966 under the Chief of Naval Material, and one of DOT's most significant contributions is the *Handbook of Vehicle Electrical Penetrators, Connectors and Harnesses for Deep Ocean Applications* (31).

Based on an exhaustive investigation into past and present penetrators, connectors and harnesses (cables) used in deep submergence, the Handbook presents the factors involved in design and development of these components and includes the advantages and limitations of designs which have seen application. The Handbook serves not only

the designer of future submersibles, but the operator of present vehicles as well. Use of the information therein could avoid some of the major obstacles to an otherwise successfully designed vehicle.

Owing to the comprehensive, wide ranging nature of the Handbook, it would be redundant herein to relate the many and varied problems encountered along the way to reliable or even quasi-reliable electric components. Hence, this discussion will only highlight and broadly define the nature of the component and its application.

### Electrical Penetrators

An electrical penetrator serves to pass power or signals through the wall of a pressure-resistant capsule, *e.g.*, pressure hull or battery pod. In this role it must satisfy two collateral duties: 1) Seal and insulate the thru-hull conductors, and 2) preserve the hull's watertight integrity under both normal and abnormal (short circuit) conditions.

Some 33 companies in the U.S. manufacture electrical penetrators and connectors; the variation in design and components precludes any one schematic representative of the electrical penetrators.

Consequently, the penetrators described are selected from various depth ranges merely as an introduction to past and present technology.

**ASHERAH**, a 600-foot submersible, uses a penetrator incorporating the stuffing-tube type of seal which was one of the first designs used in military submarines (Fig. 7.17a). Pressurization of the materials to obtain a seal is accomplished by tightening the inboard gland nut. One limitation to a jam type of seal such as this is determining the correct amount of pressure to apply which will prevent the cable from extruding into the hull yet not damage the cable and which, at the same time, will assure watertight integrity. Repressurization is required from time to time to compensate for the compression set of the packing and cold flow of the conductor jacket material. The penetrator used by Beebe (which carried two power conductors and two telephone cables) in the **BATHYSPHERE** followed the stuffing-tube principle.

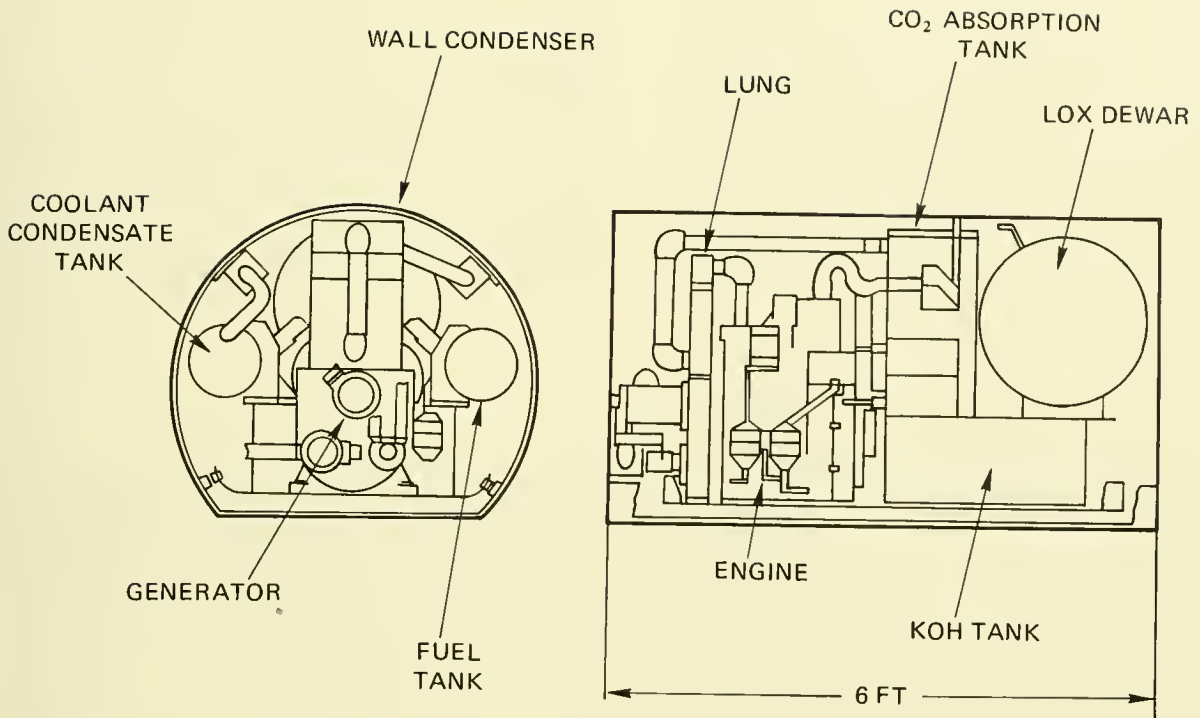

Submersible Power Supply

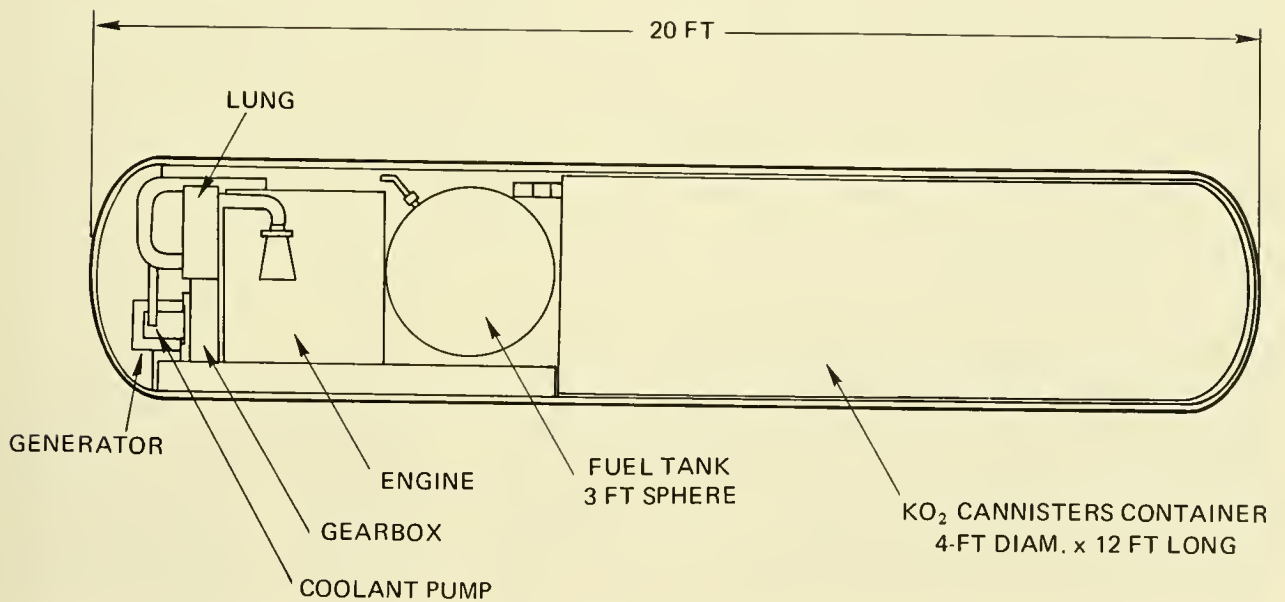
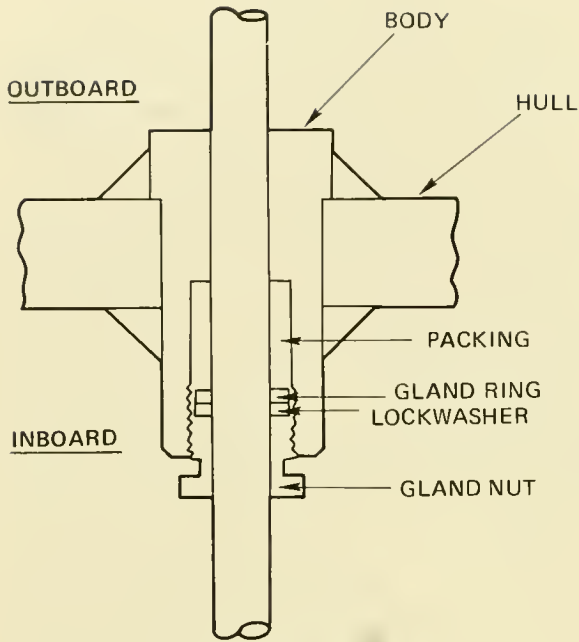
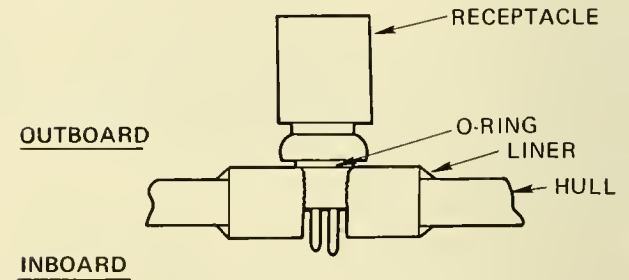
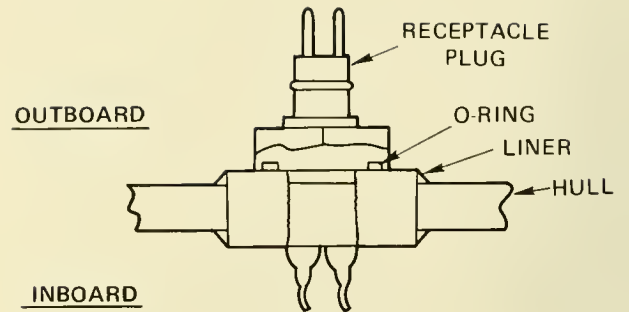

Fig. 7.16 Submersible power pod. [From Ref. (30)]



a. ASHERAH Stuffing Tube



b. Perry Submarine Penetrator

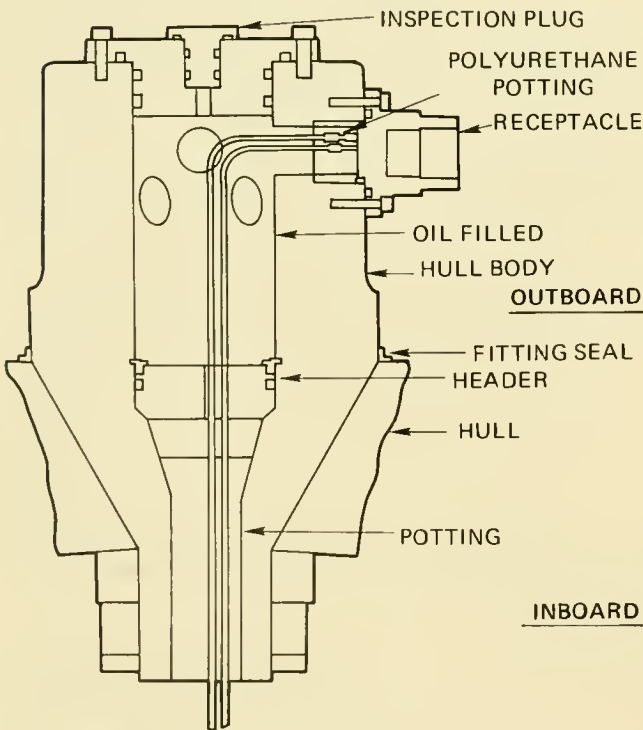

c. Redesigning ALUMINAUT Penetrator

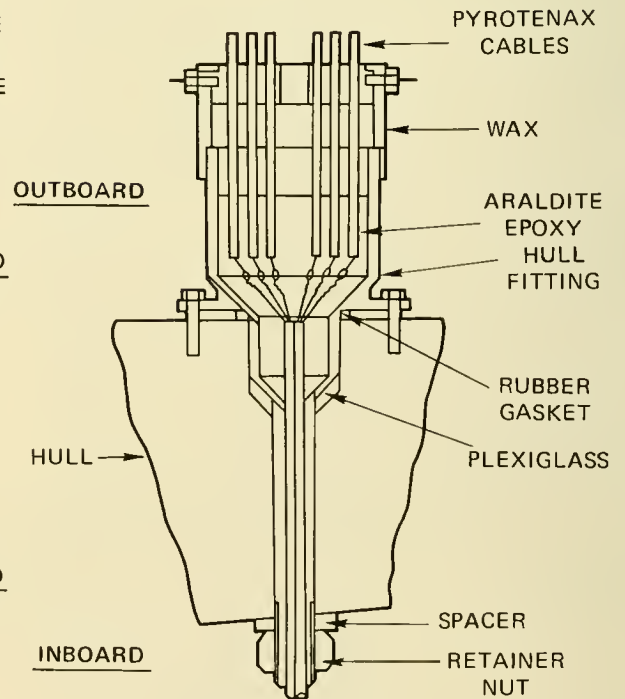

d. TRIESTE I Penetrator

Fig. 7.17 Some examples of submersible electrical penetrators.

**DEEP DIVER**, a 1,200-foot vehicle, uses both Vector and Electro Oceanics (EO) penetrators. An EO type penetration is shown in Figure 7.17b (bottom) and Figure 7.18 shows outboard configurations of the same penetrator. The receptacle is essentially screwed into a stainless steel insert and the cable then connected thereto. A number of blanked inserts are shown in Figure 7.18; these can be used for additional electric penetrations or whatever is required. Similar EO penetrators are used on General Dynamics' **STAR II** and the **DEEPSTAR 4000**.

**ALUMINAUT**, designed for 15,000 feet, uses three Vector-built and General Dynamics-designed penetrators. The body of the penetrator is of 7079 T6 aluminum, the same as the hull, and is a metal-to-metal seal. The tapered body is held into the hull with an inboard retainer nut. The connectors are mounted to the outboard end of the penetrator and comprise plastic bodies with the plugs of molded rubber. Troubles at the outboard plug-receptacle interface prompted a redesign which is shown in Figure 7.17c.

In the **TRIESTE** design (by Piccard) the

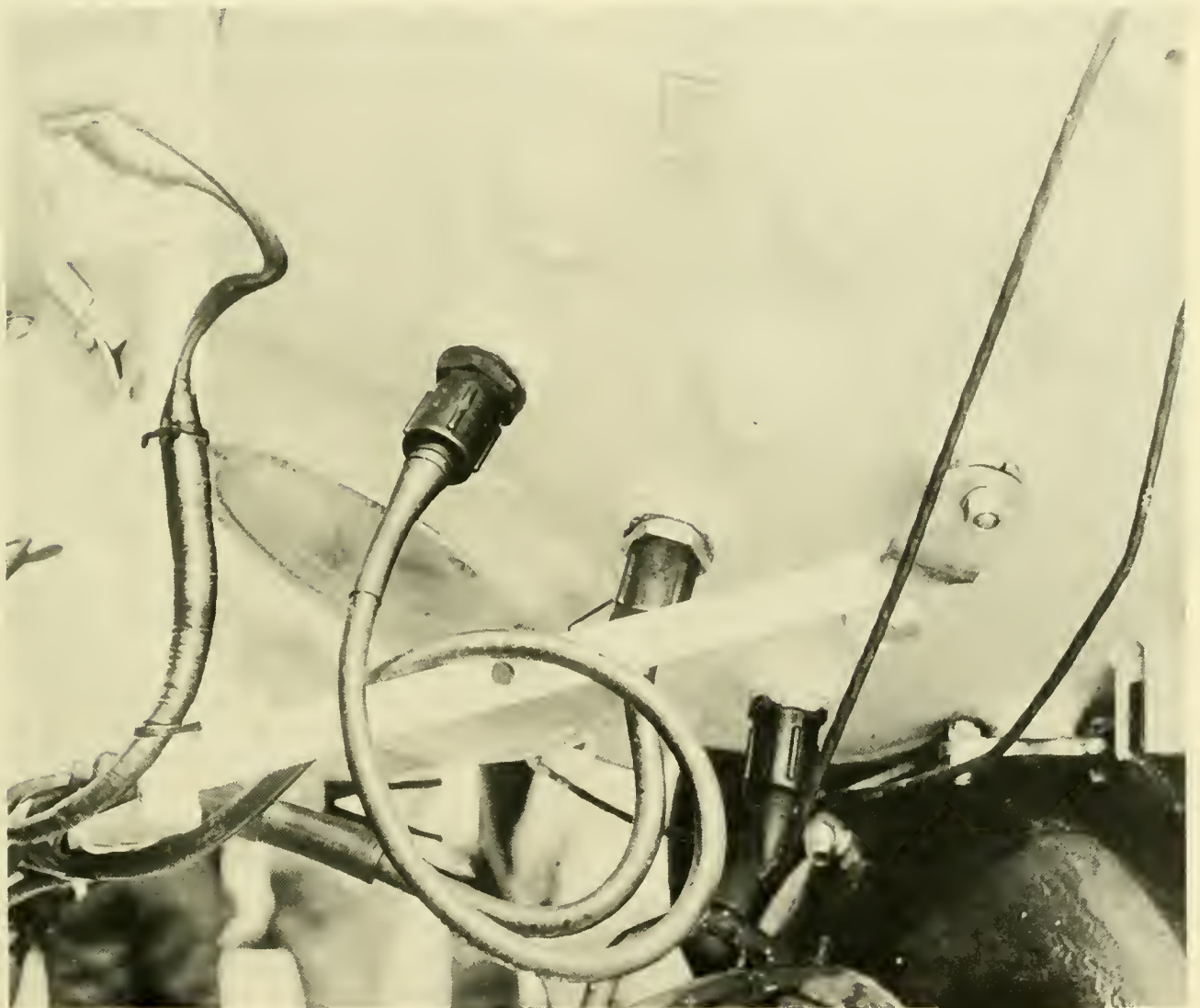

Fig. 7.18 Electric power thru-hull connector on **DEEP DIVER**. (NAVOCEANO)

pyrotenax cables are sealed to the penetrator body with an epoxy potting compound and a soft wax overlay (Fig. 7.17d). Should the epoxy material crack over periods of service, then the wax under hydrostatic pressure would seal the voids. The cables are prevented from being axially forced into the sphere by washers brazed to the cables. These washers have the proper amount of surface area to withstand the hydrostatic pressure. The penetrator body is sealed to the pressure sphere with a conical plexiglass ring which is pressurized initially by a retainer nut inside the sphere. The nut holds the fitting to the hull and initially pressurizes the plexiglass material to effect a seal at low pressures. The seal becomes more effective with depth due to high hydrostatic pressure on the penetrator body. Similar penetrators are used on *FNRS-3*, *ARCHIMEDE* and *BEN FRANKLIN*.

The *BEN FRANKLIN*, during its Gulf Stream Drift, used two other commercial penetrators: A Viking penetrator and a British design known as the "molded gland" (Fig. 7.19). Additionally, a specially designed penetrator, basically a 13-mm-diameter copper rod 215 mm long with a bronze machined collar on the outboard end, was used to carry power from the batteries into *BEN FRANKLIN*'s hull; similar penetrators also serve for battery charging and shore power. Figure 7.20 shows these specially designed penetrations carrying main propulsion power through the hull, and Figure 7.21 shows their construction.

The British "molded gland" penetrator has been used by Royal Navy submarines for several years with no reported failures (32). It was originally designed for underwater cables and saw its first U.S. application in 1969 on the *BEN FRANKLIN* (Fig. 7.22). A paper by K. R. Haigh (33) describes the molded gland and its advantages over other systems. The basic principle of this gland is as follows: The polythene (polyethylene)-insulated cable core passes through the pressure hull, which is locally deformed by a protruding hollow spigot with a castellated external surface. The seal is formed by molding polythene around the castellated spigot and the cable core. On cooling, the core insulant becomes homogeneous with the poly-

thene, which also contracts on the castellated surface. The application of water pressure increases the contact pressure between the polythene and the spigot, thus making the gland inherently self-sealing. Pretreatment of the spigot by the application of a thin film of polythene bonded to the surface ensures that the molded polythene bonds to the castellated surface. If the cable is severed outboard at the hull, ingress of water is prevented during the molding process by forcing epoxy resin under pressure down the interstices of the multi-strand conductors thereby eliminating any voids which may be present between sheath and conductor. For a period of 1 year, glands of this type were subjected to a water pressure of 5 tons/square inch without any evidence of penetration. Each gland is supplied with tails on both the high and low pressure sides and installation consists of screwing the gland body into a prepared housing in the submarine pressure hull.

To join the two cable tails together, a portable injection-molding machine shoots a hot charge of polythene under hand pressure from a gun into a transparent Perspex (plexiglass) mold clamped around the section of cable core or sheath requiring re-insulation. The use of Perspex, which has a relatively low thermal conductivity, avoids the need for heating the mold, while ensuring that the injected polythene is not cooled at a rate which would prevent its complete amalgamation with the conductor insulation or sheath. It also permits the operator to watch the filling of the mold right up to the time when reinstatement of the insulation is complete. The complete joint can be tested hydraulically by clamping a water jacket around the cable and applying any required pressure. By this means, the complete external electrical system can be tested for water-tightness to full diving depth and beyond while the submersible is still being built or at the dock.

This system is described in some detail because it departs radically from U.S. systems, in that, there is a continuous hard line conductor running from the external instrument into the hull. U.S. systems, on the other hand, contain separate conductor contact points externally at either the hull or a connector, and again at the cable and the

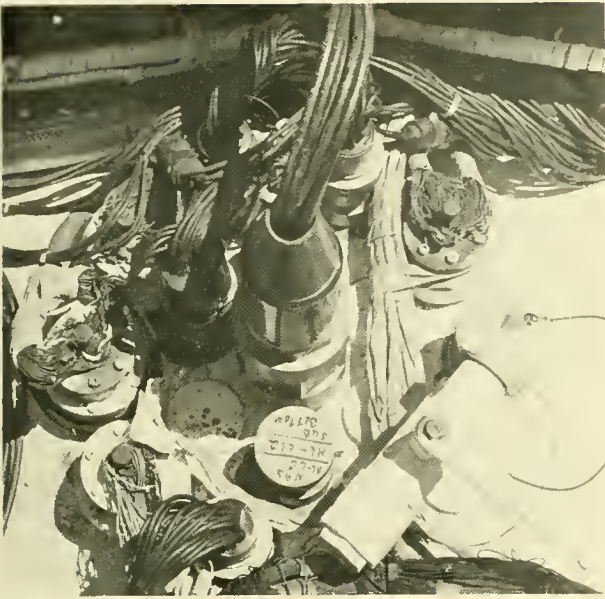

Fig. 7.19 A variety of penetrators on *BEN FRANKLIN* (NAVOCEANO)

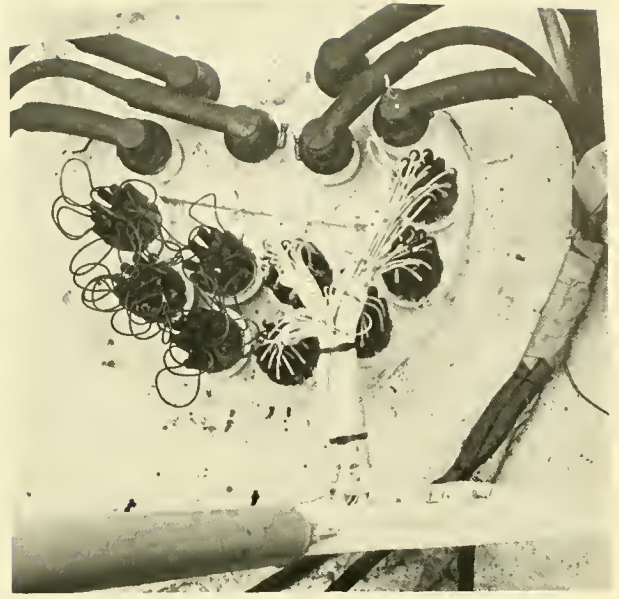

Fig. 7.20 Piccard penetrators with Marsh Marine (Vector) connectors and specially-designed main power penetrators on *BEN FRANKLIN*. (NAVOCEANO)

instrument. It is these connect/disconnect points which cause most of the trouble.

The DOT program identified some 30 different penetrator types used on underwater vehicles and, based on failure modes and effects analyses, compiled a list of 22 design considerations applying to electrical penetrators. Such details are beyond the scope of this discussion, but from a historical and state-of-the-art point of view four design fac-

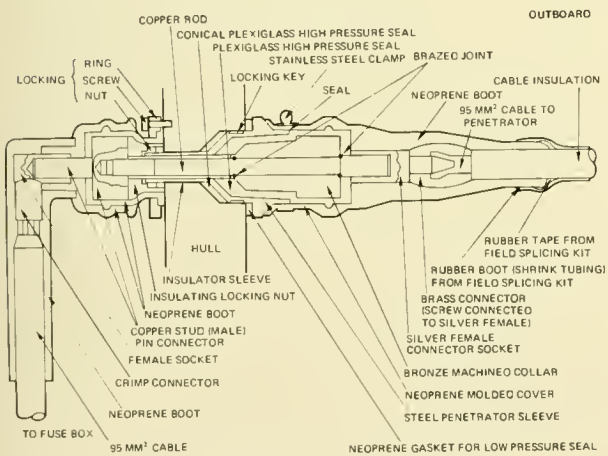

Fig. 7.21 Electrical penetrator (95 mm) on *BEN FRANKLIN*.



Fig. 7.22 A molded gland atop a 3.5-kHz transducer. (NAVOCEANO)

tors should be mentioned: entry configuration, hull fastening methods, hull sealing methods and hull insert types.

**Penetrator Entry:**

Cable can enter the hull vertically (Fig. 7.17a), or at any angle from vertical to horizontal (Fig 7.17c). The horizontal entry provides the most advantages because the cables can be supported and protected more easily.

**Hull Fastening Methods:**

Several methods exist to secure penetrators to the pressure hull (Fig. 7.23). Briefly, the following comments can be made for each approach:

- a) **Bolted Flange**—Bolting directly to hull may produce a stress concentration area; the flange consumes a large surface area outside the hull and may also cause crevice (and other) corrosion problems.
- b) **Internal Lock-Nut**—The most widely used method, it provides the least problems.
- c) **Welding**—This conserves space but is permanent and, therefore, hampers re-

placement for maintenance. Also, some hull materials are not weldable.

- d) **Adhesives**—These have a low confidence level at present.
- e) **Direct Screwing**—This poses machining and stress concentration problems.

**Hull Sealing: (Fig. 7.24)**

In this respect replacement or removal of the penetrator for inspection is a general requirement. Therefore, welding or adhesives are precluded.

- a) **Flat-Gasket**—This requires periodic re-pressurization.
- b) **O-rings**—These provide excellent low pressure seals, most widely used.
- c) **Metal-to-Metal Tapered Seal**—An eighty percent metal-to-metal contact is desired and very precise machining is required.

**Hull Insert Types:**

The basic insert types are shown in Figure 7.25. Threaded, tapered and conical inserts are found in most submersibles. In the conical insert a plastic gasket is pressurized into the cone area by tightening an inboard lock-nut. Stepped hole inserts create stress concentra-

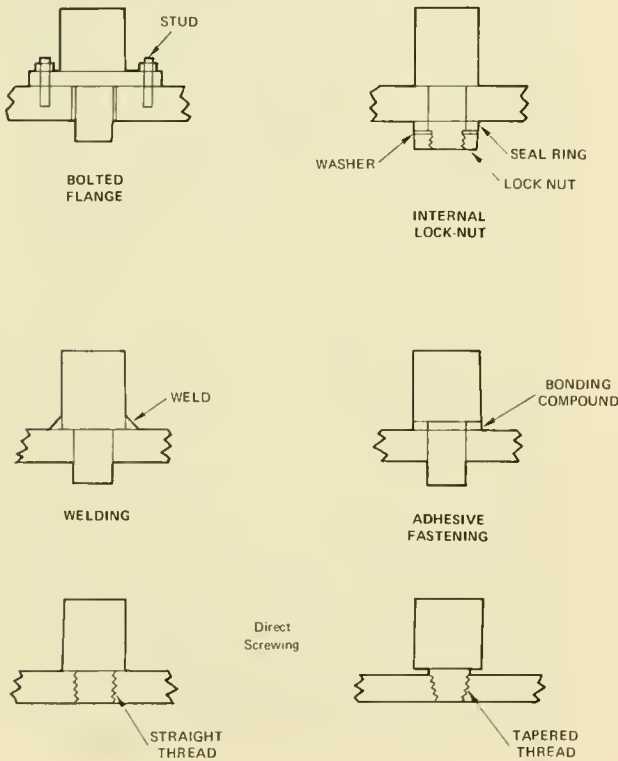

Fig. 7.23 Penetrator to hull fastening methods.

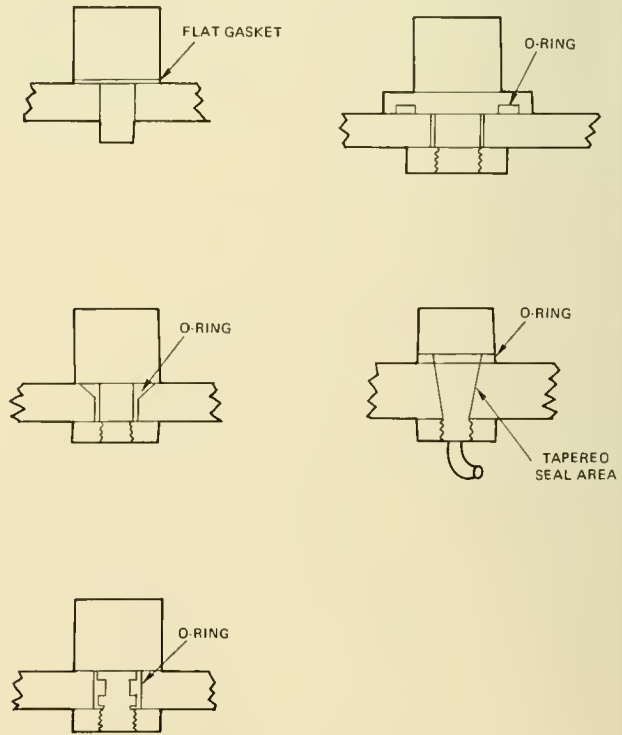

Fig. 7.24 Penetrator to hull sealing methods.



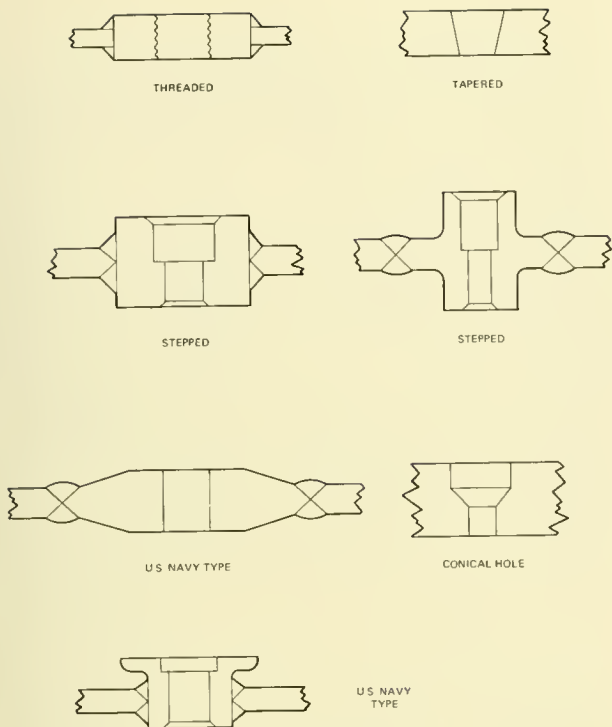

Fig 7.25 Typical hull inserts for electrical penetrators

tions, and thus a tapered hole is favored, although individual matching of each penetrator may be required to fit each insert. The hull insert material must be the same as the hull material and full penetration welds at the insert-hull interface are desired.

## Electrical Connectors

Cables (harnesses) and connectors for electrical components have been the most failure prone items on subsmeribles, and, while such failures may not jeopardize the occupant's safety, they can result in the loss of time, money and good diving weather in the form of aborted dives and subsequent down-time for repairs.

Any attempt to lay the blame for connector and cable failures reduces to the dilemma of "Who struck John?" Earlier, Ryniewicz (2), a user of connectors, cautioned subsmerible designers that cables, connectors and circuit breakers constituted the major areas for improvement in deep submergence. Another user, a senior engineer for Perry Submarine Builders, recently replied to a query regarding the connectors they found most reliable: "We use one until we get disgusted with it and then replace it with another until we've

had enough of it!" International Hydrodynamics, as noted above, finally gave up and makes its own connectors and penetrators.

Conversely, J. D. Tuttle, a manufacturer and vendor of connectors (Electric Oceanics, Inc.), states (34) that much of the fault resides with the user for not establishing specifications which completely encompass the boundary conditions within which the connector must function. Furthermore, Tuttle suggests that the user may not understand, among other things, the maintenance procedures and limitations of a perfectly well designed and manufactured connector. D. K. Walsh (35), a manufacturer (Vector Cable Co.), also lays the blame on the user and states that the principal area of abuse has been in misapplication, mishandling and careless installation.

A revealing insight into the problem is provided by the DOT Handbook in the form of a Failure Mode and Effects Analysis, for connectors, penetrators and junction boxes. The investigators identified 142 modes by which failures of these components could occur. The failures are grouped under *Inherent* (manufacturing design deficiency and material fatigue) and *Induced* (installation/assembly deficiency, maintenance deficiency, excessive operational demands and rough handling). If it is assumed that inherent deficiencies are laid to the manufacturer and induced to the user, then the user appears to be the chief potential culprit, for in 181 out of 297 causes of failure the user is to blame. To clarify these figures it should be noted that both user and manufacturer may be found guilty in the case of one failure, for example, where insulation material breaks down due to use of contaminated materials, the cause could be inherent in the original design, or induced through installation/assembly, improper use or deficient maintenance.

It would appear, then, that both manufacturer and user share somewhat equally in the problem, the former by ignoring various ramifications; the latter through ignorance or inattention to details.

### Connector Design:

There are dozens of companies in the U.S. which produce connectors both for commercial application and for which the military has supplied specifications. Military speci-

cations for a general-purpose connector most generally applied in undersea application are described in Navy Bureau of Ships MIL-C-24217. Connectors for the civil sector in general application are supplied by Vector (formerly Marsh Marine), Joy, Electro Oceanics, D. G. O'Brien, Viking Industries and ITT Cannon Electronics. In addition to those noted, a variety of other companies produces standard and special purpose connectors. No specific point, other than displaying the mind's ingenuity, would be served by describing each connector in detail. For those interested in such details, reference (36) is recommended. For a more general overview the results of the DOT program will serve adequately wherein five basic designs were evolved from the multitudes which "*... seal the cable and provide the desired electrical continuity between components*" (31); these are:

- a) Cable stuffing tube component penetrator
- b) Pressure proof electrical connector
- c) Molded cable penetrator
- d) Molded cable penetrator with insulated backing header insert
- e) Flange mounted polyethylene molded plug penetrator.

All of these devices (Fig. 7.26) are similar to those noted for electrical hull penetrators. Pressure proof electrical connectors (Fig. 7.27) are of major concern because of their more widespread use. Connectors of the type shown in Figure 7.26 offer several individual advantages—*e.g.*, they may be inexpensive and quite reliable—but the major disadvantages outweigh the advantages, to wit: The penetrator must be scrapped if the cable is damaged in service, and, most importantly, there is no convenient disconnect point at the component. Numerous other advantages of the pressure proof electrical connector are outlined in reference (31).

An electrical connector consists of a plug and receptacle assembly. The heart of the connector is the pin and socket contacts which make the electrical junction. The majority of connectors in use today can be divided into four types based on construction material. These are:

- a) Metal plug and receptacle
- b) Molded rubber plug and receptacle

c) Plastic plug and receptacle

d) Underwater disconnectable connector.

The following comments regarding the advantages and disadvantages of the above connectors are taken from the DOT Handbook.

#### **Metal Shell Connector:**

The metal construction which provides a rigid skeleton has demonstrated the greatest degree of reliability on submersible equipments. The nature of the design requires more component parts, is heavier and has greater initial cost. However, these disadvantages are more than offset by a higher degree of reliability and resistance to installation and environmental damage. The added initial cost becomes insignificant when related to overall system cost and the critical role a connector plays in a system's satisfactory performance. A single connector failure can abort an entire mission.

The metal plug shell provides a rigid and adequate bonding surface for the cable seal and thus provides adequate cable strain relief at this point. The rigid construction makes possible a greater degree of wire position control in molding a cable to the plug and, therefore, much less chance of electrical shorts or opens due to uncontrolled migration of conductors during the cable end sealing process. The metal shell provides a positive stop for controlled gasket squeeze in seal areas between plug and receptacle and between receptacle and mounting surface. Metal has the necessary strength and dimensional stability to provide reliable threaded parts. A metal receptacle shell provides the necessary support for a positive and reliable pressure barrier in case of accidental exposure to sea pressure. Metal construction provides for a more reliable mounting of bulkhead types and an additional mounting method, namely a seal weld. An individual insulator in combination with snap-in socket contacts provides good contact positioning for proper mating alignment. Metal bodies are best adapted for positive keying to polarize plug with receptacle. Where both plug and receptacle shell are of a nonresilient material, a more reliable coupling can be accomplished. Elastomer compression set and material flow with resulting loosening is not a problem.

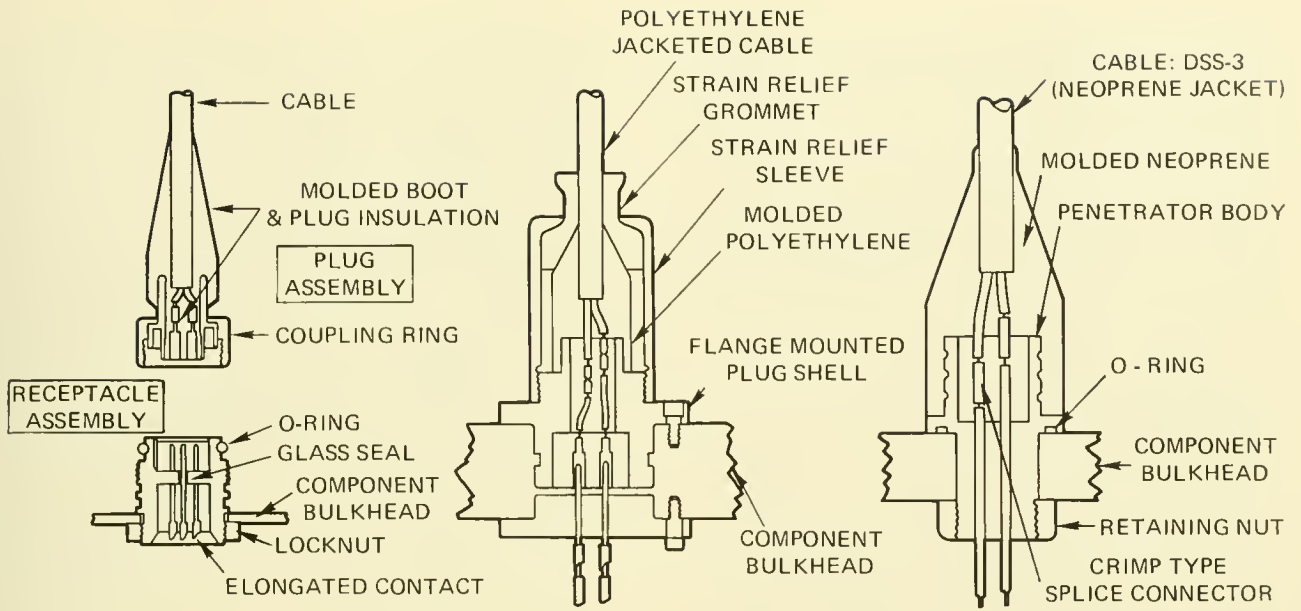

Pressure Proof Electrical Connector

Flange Mounted Polyethylene  
Molded Plug Penetrator

Neoprene Molded Cable Penetrator

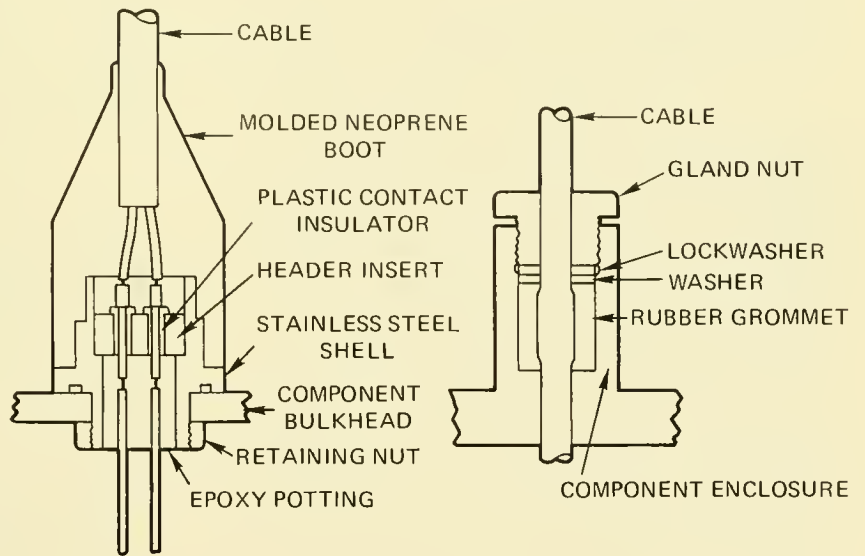

Molded Cable Penetrator With  
Insulated Backing Header Insert

Cable Stuffing Tube  
Component Penetrator

Fig. 7.26 Five basic designs for sealing a cable and transmitting electrical power between components.

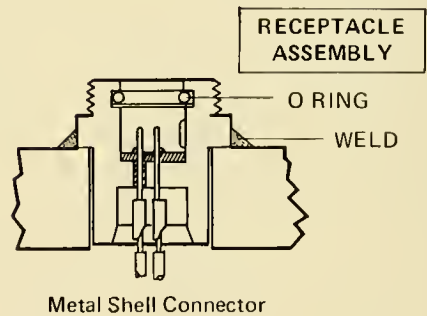
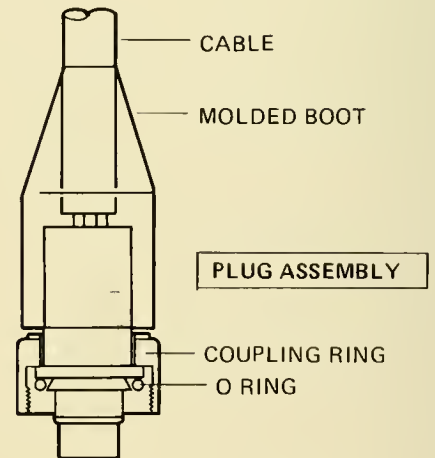
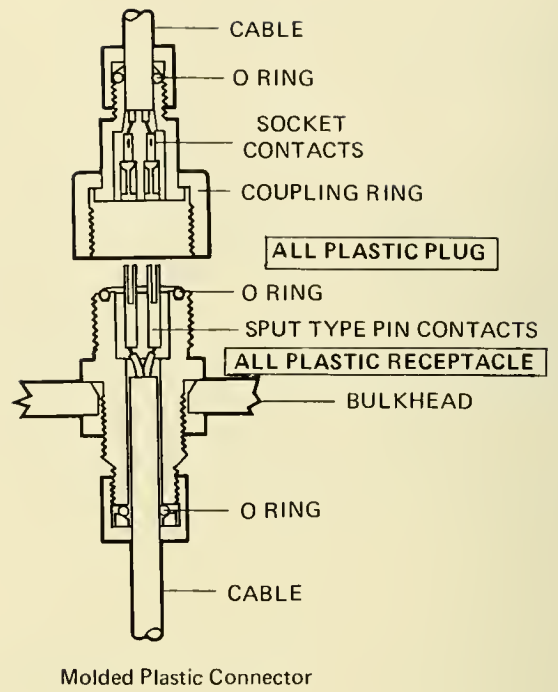
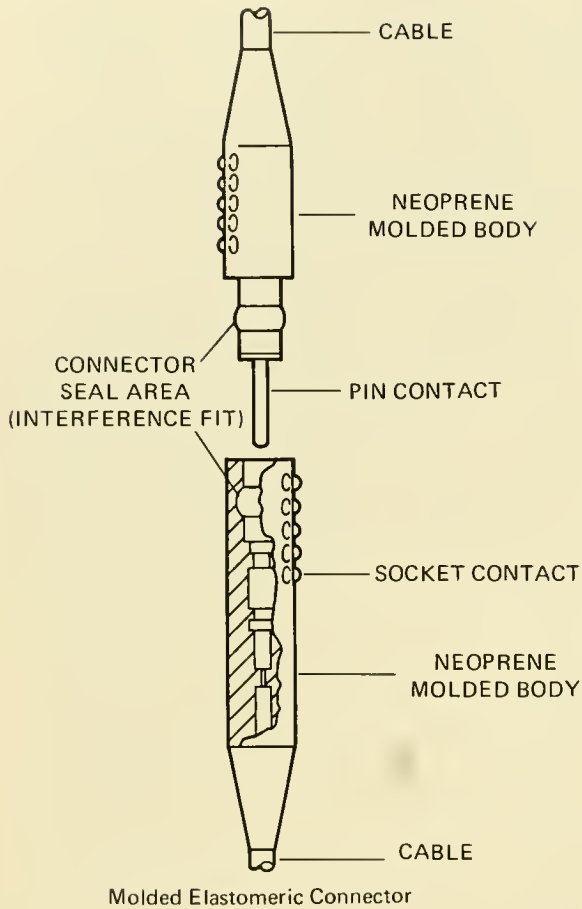

Fig. 7.27 Types of connectors presently in use.

Disadvantages of metal connectors include: The need for additional individual contact seals which are inherent in the integrally molded rubber type connector; danger that sealing surfaces may be damaged, causing possible seal failure; susceptibility to corrosion, depending on material choice, environment and the influence of other interfacing metals and/or stray electrical currents; need for insulation to provide electrical isolation of the conductors; and the need to secure and seal these parts. Additionally, applications that require the metal connector to be subjected to a considerable degree of pressure cycling call for special attention to the manner of wiring and how the conductors are supported in the back end of the plug between the cable-end seal and the conductor termination. Otherwise, fatigue failure of the conductor can occur. Where nonresilient parts interface at plug and receptacle, a minimum volume void is always present because necessary dimensional tolerances preclude interfacial contact at this point. This void can account for some electrical degradation due to condensation of moisture in the contact area. This can be significant depending on application and environmental temperature and humidity ranges. Contact insulation composed of compression glass seals must be adequately protected from welding temperatures when components are fastened or sealed by this method.

#### **Molded Plastic Connector:**

The molded thermosetting resin type of connector construction is relatively inexpensive and ideally suited to volume production. It has many of the same advantages as the all rubber type. For example: It takes fewer components; integral molding requires no internal seals; no insulators are required as the structural material itself is a good dielectric; and the material is not subject to salt water corrosion, since it cannot form a galvanic couple with adjacent metal parts.

However, experience has indicated that plastics have many deficiencies as a connector fabricating material. Any one specific thermoplastic or thermosetting resin material does not seem to combine the desirable electrical properties with all the required physical and mechanical properties necessary for use as a deep submergence connec-

tor. Some of these properties include a high degree of dimensional stability, high impact strength, low mold shrinkage, low water absorption, high compressive strength and non-flammability.

Fabricating requirements further limit the material choice. These include good moldability—especially with any necessary reinforcing fiber content—at reasonable temperatures and pressures. Some of the more common defects found in molded connector parts include the following: Cracks at points of high stress which are generated in the molding process and proliferate with use; threads that fail under load or are damaged by impact; failure in areas that are molded resin rich and lack the necessary fiber content; seal surfaces that do not present the required finish due to excessive flash or porosity; and a tendency under higher levels of pressure cycling towards minute fiber displacement, followed by fatigue and eventual structural failure.

Though the molded plastic connector has exhibited serious design deficiencies to date, especially for higher pressure applications, it is quite possible that the proper combination of material and design would produce a satisfactory connector for low pressure applications.

#### **Molded Elastomer Connector:**

The molded or cast elastomer type of connector construction provides the least expensive type of underwater connector. Basically, this type of connector consists of a length of cable whose conductors are terminated with male or female plugs. The entire terminal area is molded or cast integral with the cable jacket. The contacts are positioned by external means until curing or vulcanizing is complete. The geometry of the molded area is such as to provide a sealing interface between plug and receptacle and to provide for strain transition between contact area and cable. Because of the resilient qualities of the material used, relatively thick sections are required to provide adequate polarization between plug and receptacle. This results in a large connector. For this reason, polarization, where present in this design, is normally accomplished by contact pattern or by the use of two or more different contact diameters. Neither method is adequate be-

cause electrical contact between plug and receptacle is not possible prior to proper alignment and mechanical locking. For this reason, this type of connector is vulnerable to electrical mismatching and contact damage.

The materials most often used in fabricating this connector are neoprene for pressure molding and polyurethane for cast molding. The neoprene molded connector is superior in several design areas. However, the inability to properly control movement of the conductor during the pressure molding process can lead to electrical opens and shorts that very often don't appear until after the connector sees the operating environment. Thus, reliability is seriously affected.

The all rubber type of connector, not having a rigid internal or external structure, does not provide for positive and controlled compression of interfacial seals. For the same reason, most coupling and mounting devices are marginal because the material is subject to compression set. Seal failure can also occur when the connector is mated in a low temperature environment, due to loss of elasticity. Most designs have little or no protection for pin contacts.

This type of connector construction is not without certain advantages. Among these are low cost, light weight, capability of withstanding considerable abuse and, because it is integrally molded, a need for fewer seals. Both plug and receptacle withstand open face pressure equally well. No material corrosion problem exists and the material being a dielectric does not contribute to galvanic corrosion of adjacent areas. No separate insulating parts are required and the resilient material provides for a void-free interface between mated plug and receptacle.

#### **Underwater Disconnectable Connectors:**

Underwater disconnectable, or make and break, connectors are a definite requirement for submersible applications. For instance, it is advantageous for divers to be able to disconnect camera and light housings while the vehicle is still in the water. This allows replacement of film and lights on a routine basis without the need to haul the vehicle from the water. Another disconnectable connector requirement is the one-time electrical disconnect that is required when emergency

drops are made of outboard mounted equipment such as batteries and manipulators. These equipments would be disconnected from the vehicle under conditions of emergency surfacing; it may also be necessary to drop the manipulators should they become entangled during underwater operations.

Electro Oceanics has developed and patented an underwater make and break connector wherein both the male plug and female receptacle are molded of a nonwetting elastomer, neoprene, to which the metallic contacts are bonded (Fig. 7.27). An interference fit between plug and receptacle causes a wiping action as connection is made. By slightly constricting the front face of the female opening and slightly flaring the end of the male, the entire male surface is wiped clean as is the interior of the female with excess water or salt film being ejected to the rear. The purging action is so effective that the connector can be plugged and unplugged in salt water with a resultant leakage resistance exceeding 100 megohms.

As one part of the DOT Program, the Crouse-Hinds Company of Syracuse, New York, developed an underwater make-break connector capable of operation at depths to 1,000 feet. A flexible bladder provides volume compensation for changes due to pressure or temperature, and a method employing one active and one dummy rod maintains zero displacement when connection is made. Tests to 15,000 psi show no damage to the connector and subsequent development is aimed at multicircuit use. A complete description of this novel approach and its advantages are presented by Small and Weaver (37).

Prior to completion of the DOT Program's Connector, Cable and Harness Handbook, several manufacturers and users published state-of-the-art reports of these components which included recommendations for the future and described the techniques employed on a few specific vehicles. These reports and articles are included in references (38) through (42) and are mentioned herein, not only for historical reasons, but also to give the views of both users and manufacturers. A more recent development in penetrators in Figure 7.28 shows Electro Oceanics' titanium penetrator for the 12,000-foot titanium hull of *ALVIN*.

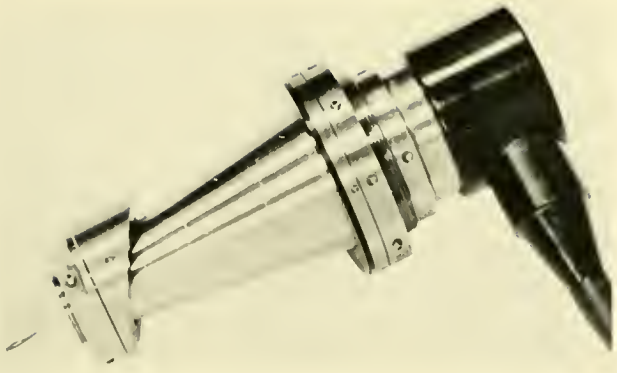

Fig. 7 28 "PROJECT TITANES." (WHOI)

## Cables

The primary function of a pressure proof harness assembly is to provide an electrical interconnection point from the electrical hull penetrator to the outboard electrical/electronic component. A harness assembly is a pressure proof cable with connectors wired and sealed to each end (Fig. 7.29). The harness is used outboard of the pressure hull

and usually runs from the hull's electrical penetrator or outboard distribution box to an outboard electrical component. Many types of harness assemblies can be considered and have actually been used on submersibles (Fig. 7.30). However, the majority of those used to date employ rubber jacketed cables. Metal-sheathed, mineral-insulated cables have been used on a few European vehicles, but almost all U.S. designs have made use of conventional neoprene jacketed cables.

Another output of the DOT program is the Handbook of Electric Cable Technology for Deep Ocean Application (44), a guide prepared for deep submergence designers, engineers and operating personnel. The Handbook is a compilation of engineering criteria obtained from literature surveys, experimental investigations and consultation with manufacturers, and provides detailed discussions of material selection and construction requirements for reliable deep-ocean cables. Additionally, a glossary and a varied collec-

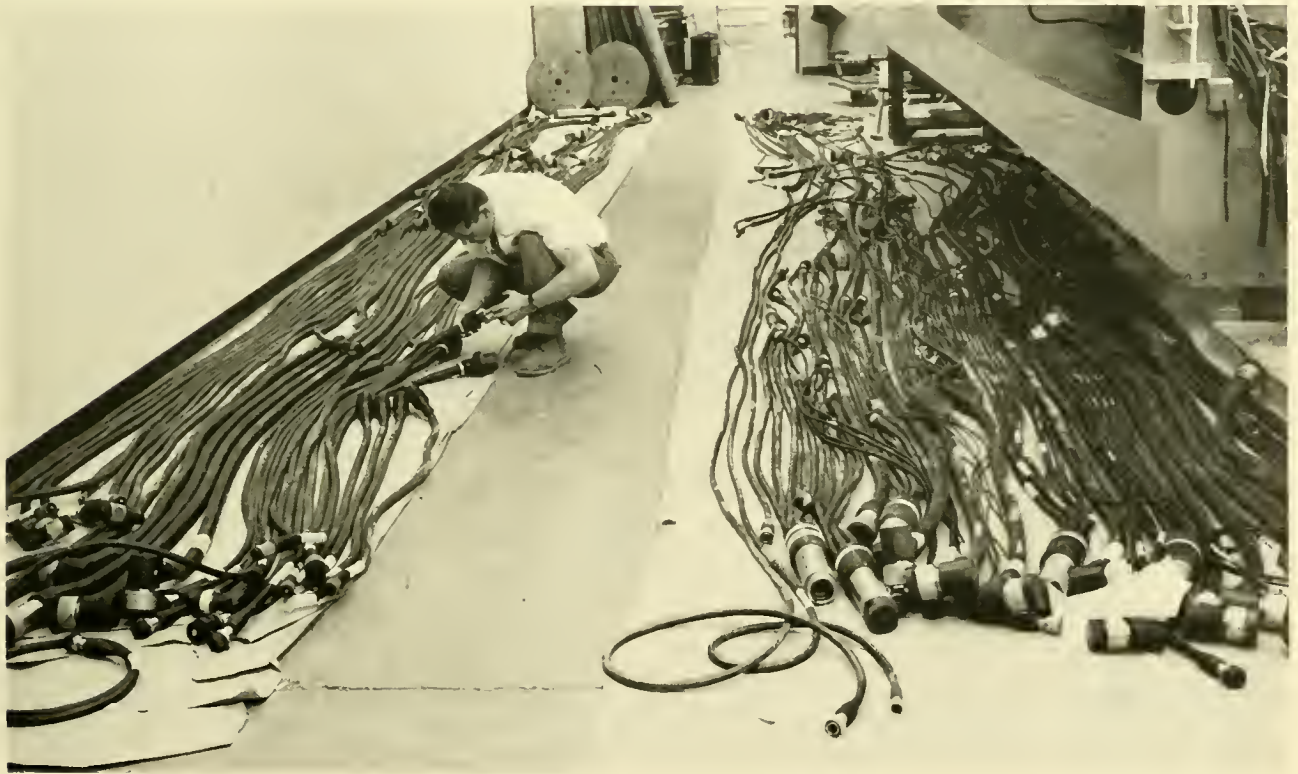

Fig. 7 29 Harness assemblies for *DEEP QUEST*. (LMSC)

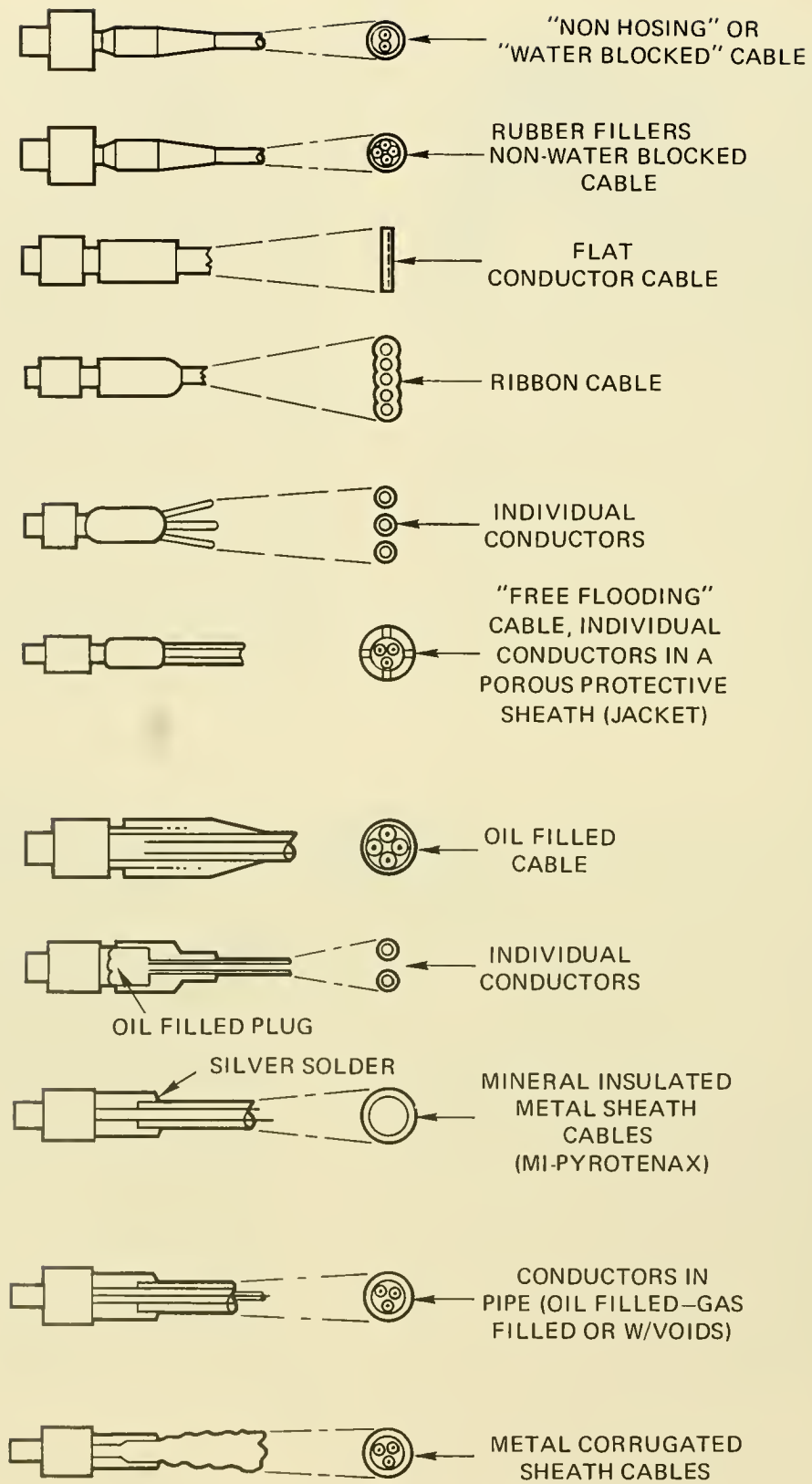

Fig. 7.30 Submersible pressure proof harness types.



tion of useful tables are included. Because the subject of cables is covered exhaustively in the Handbook and references (31) and (36), only a cursory discussion is given herein, and it is taken directly from the above sources.

As with so many other components of submersibles, the selection of outboard cabling for privately owned vehicles depends both on the designer's personal choice and availability. Among the options are single insulated conductors, standard commercial cables, oil filled cables, welding cable, metal sheathed cables and hybrid cabling systems. Typical problems encountered include:

1. Incompatibility of insulation and jacket compounds with pressure-compensating fluids.
2. Water penetration of cable jackets and molded plug terminations.
3. Cracking of cable sheath.
4. Problems of potting plug molding compounds to cable jackets and metal shell of plugs.
5. Conductor breakage at molded plug terminations.
6. Instability of electrical characteristics with change in hydrostatic pressure or with long-time immersion.
7. Breakage of braided shields under repeated cable flexing.
8. Mechanical damage during vehicle servicing.

Mr. D. K. Walsh (35) summed up the situation quite succinctly in a 1966 report to the Marine Technology Society: "Historically, the cable problem has been treated as an afterthought." Walsh proceeded to develop a historical account of cable selection (whatever seemed adequate), terminations to associated equipment (trial and error) and the means of connecting equipment to a power source (whatever method came to mind). Tracing the evolution of combining cables and connectors, Walsh described an early approach known as the "Schlumberger Splice" (Fig. 7.31) which worked satisfactorily with single conductor cables. From this developed multi-pin, watertight, disconnect type connectors (Fig. 7.32) which are essentially throw away units, inexpensive and rugged and still in use today. These rubber molded connectors, according to Walsh, had much to do with combining the cable problem

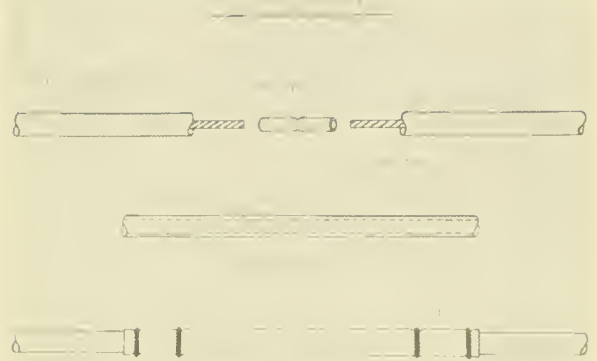

Fig 7.31 The Schlumberger Splice. (D. K. Walsh)

with the connector problem since a rubber molded connector could only be installed on or molded to a vulcanizable type of cable, *e.g.*, neoprene jacketed. This began the design of what Walsh calls an Engineered Cable System: A combination of a cable with a connector and a suitable junction, for the development of which the systems engineer must have full prior knowledge of the associated connectors and the types of junctions to be employed. Walsh's report contains a number of considerations to insure compatibility and optimum performance and is one of the first (if not the first) contemporary attempts to approach the entire cable/connector problem in a systematized, soundly engineered manner.

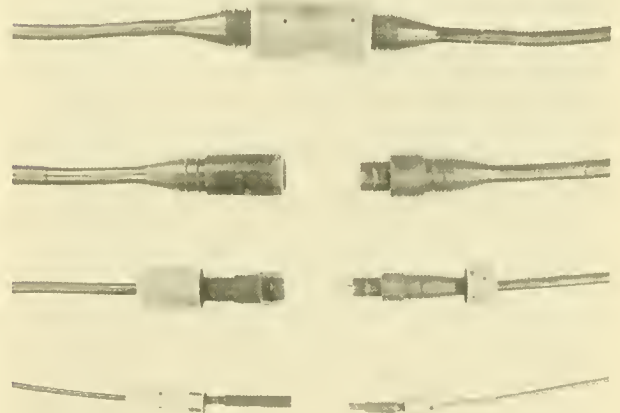

Fig 7.32 A variety of rubber-molded disconnect type connectors. (D. K. Walsh)

During the design phase of the U.S. Navy's Deep Submergence Search Vehicle (*DSSV*), Lockheed Missiles and Space Company recognized that reliability of so-called standard (Fig. 7.33) external cabling systems was questionable at depths of 20,000 feet. Subsequently, the Navy funded a design, fabrication and test program for several types of pressure-compensated cable systems.

According to Saunders (43), present cabling systems suffer the following deficiencies: They are not amenable to analytical design approach; extensive pressure testing is needed to prove design; "standard" components and assemblies are expensive, large and heavy; and cable assemblies are difficult to assemble, repair, inspect and maintain. The test program was an attempt to overcome these deficiencies through use of pressure-compensated cables.

Six compensated systems were tested and the results compared to the DSRV type of standard cabling system. Briefly, the compensated cable consisted of a Tygon tubing sheath with bare wire loosely coiled inside. The various test compensating mediums consisted of a petroleum-based hydraulic fluid, electrical box silicone fluid, mineral grade oil and silicone grease. A variety of compensation devices were used, and each of the six systems consisted of a junction box with three cable entries and two cable assemblies

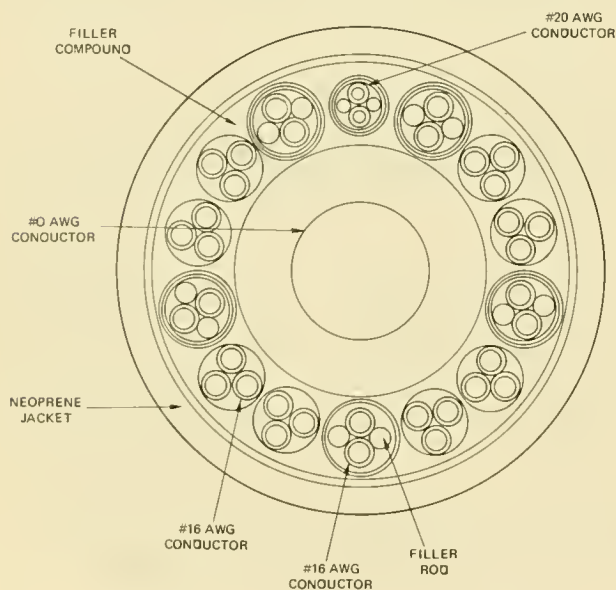

Fig 7.33 Typical power cable construction for the DSRV

with a penetrator plug on the end of one cable.

A wide variety of tests were performed, as the systems were cycled to 13,200 psi, in an effort to gain general information rather than to determine the suitability of one type of compensated system over another. It is of interest to note that, except for one leak, all test specimens met the required performance criteria. While Saunders expresses the need for further study and component development for specific subsea devices, he draws the following conclusions regarding pressure-compensated cable systems: Depth does not limit their applicability, manufacturing costs are lower than for standard cables, component costs are lower, testing costs are lower because no pressure testing should be necessary following qualification testing, procurement time is reduced, reliability is increased, cable assemblies weigh less, and measured electrical characteristics were equal to or exceeded DSRV cabling. Although the *DSSV* never progressed beyond the design stage, many of the experimental results were unanticipated and the reader is urged to consult this report for an insight into this approach to submersible cabling.

As regards reliability of undersea cables, there is revealing testimony in reference (32) which supports the earlier manufacturers' contention that mishandling and misapplication by the user are chief factors in cable harness failure. Lockheed's *DEEP QUEST* Program Manager, distressed at the high damage rate, established training programs to teach their engineers and technicians the proper methods of handling and carrying, what length could remain unsupported without damage, what kinds of containers to use for shipping and proper in-plant storage procedures. Additionally, a very rigorous shipboard inspection program was instituted and supervised by *DEEP QUEST's* Chief Pilot to assure, among other things, that connectors were tied tight, that people were not using connectors or penetrators as steps and that cables were not allowed to lay loose on the deck. Similar precautions were taken by Westinghouse in its *DEEPSTAR 4000* program.

One problem in small submersibles is that cables cannot be protected by enclosing them

in a steel trough as they are on the much larger military submarines. Also, during construction and maintenance periods tools or other devices may be dropped on them. In order to stabilize and support the cables of *STAR III* the "Halo" device shown in Figure 7.34 was used; obviously this is merely support, not protection.

### Junction Boxes

Junction boxes are used to interconnect wires or cables. On submersibles they are sometimes within the pressure hull, e.g., *SEA OTTER*, though in many cases they are external to the hull. In the *VAST* series of submersibles there is no junction box whatever, because the only electric power lines are from internal batteries to two electric propulsion motors.

When junction boxes are external to the hull, they may be pressure resistant, solid or compensated. Pressure-resistant boxes are heavy and penetrations may be costly. In some cases, however, it may be the only way to protect components that cannot withstand high pressure. Solid junction boxes (Fig. 7.35), wherein the electrical equipment is potted in a block of elastomeric material, is

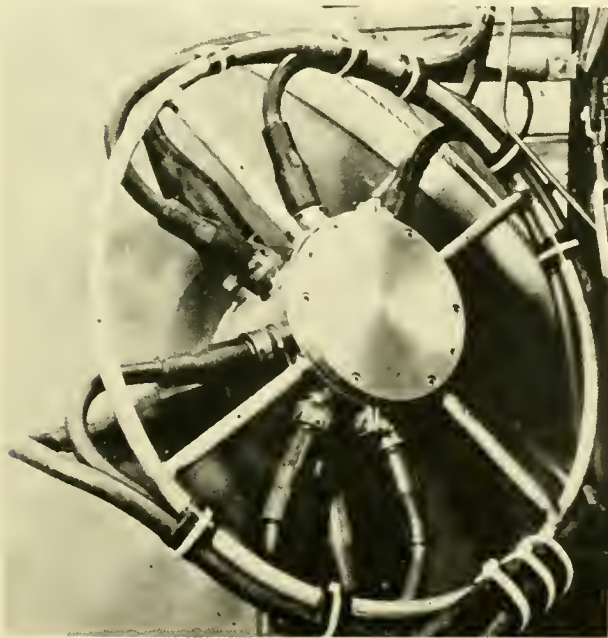

Fig. 7.34 *STAR III*'s "Halo" cable support. (Gen. Dyn. Corp.)

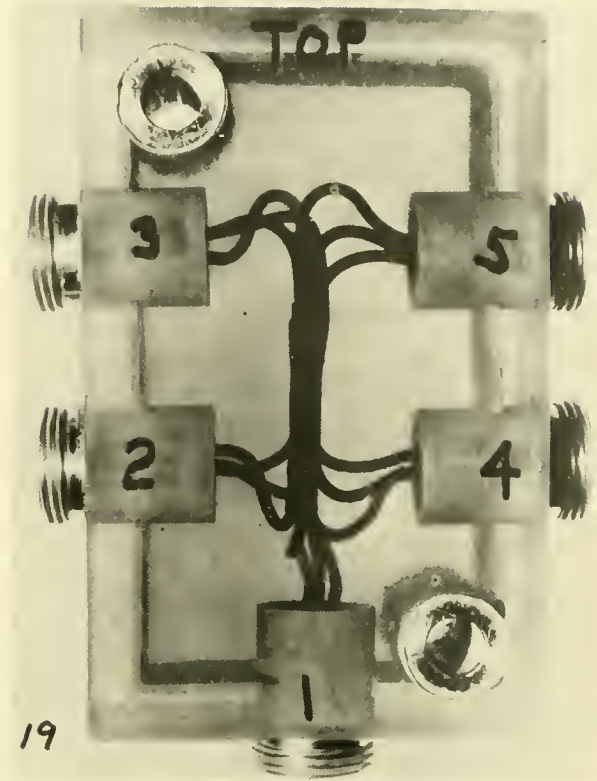

Fig. 7.35 A solid junction box consisting of 1547 amber urethane (Gen. Dyn. Corp.)

inexpensive and, if transparent, allows easy observation of the component parts. On the debit side, access to the components is quite difficult and water may intrude along potting-to-component interfaces. Equally frustrating is the fact that elastomeric materials transmit significant shear stresses, and delicate components, thus, may be ruptured or fatigued by the motions accompanying compression and decompression. As an example, in tests at General Dynamics the conductors soldered into the pin at the rear of the receptacles in Figure 7.35 experienced a number of breaks due to pressure cycling. Postmortem revealed that the urethane was compressing and pushing in, and when it pushed it dragged the conductor along with it and broke. Subsequent change to a higher strength conductor and rerouting of the wiring so that it received some support and protection from the metal frame proved satisfactory.

Pressure-compensated junction boxes offer advantages for components which can tolerate

pressurization in a dielectric liquid medium. Dielectric liquids transmit negligible shear which allows exposure of fragile components. Since the electrical resistance of all dielectrics increases with pressure (43), the chance of spontaneous arcing because of dielectric breakdown is minimal, thereby providing greater latitude to the designer of high-voltage equipment. Other advantages are realized in weight-saving and visual inspection if optically transparent dielectric and container material is used.

### Circuit Design

No two manufacturers of submersibles follow the same circuitry design or allocation of power. Consequently, it would serve little

purpose to present just one or two power schematic diagrams, for they would be representative of only themselves. In the same vein, very little has been published regarding the philosophy of circuit design, which leaves the investigator in a quandary if he wishes to base his design on other than intuition. For such reasons, the contents of this section will deal with the manner in which circuit design and power distribution should be approached, rather than how it actually has been carried out. Two sources are drawn upon for the major portion of this information: 1) The DOT Handbook on Penetrators, Connectors and Harnesses (31) and 2) course notes taken at a short course in Manned Submersibles at UCLA presented by

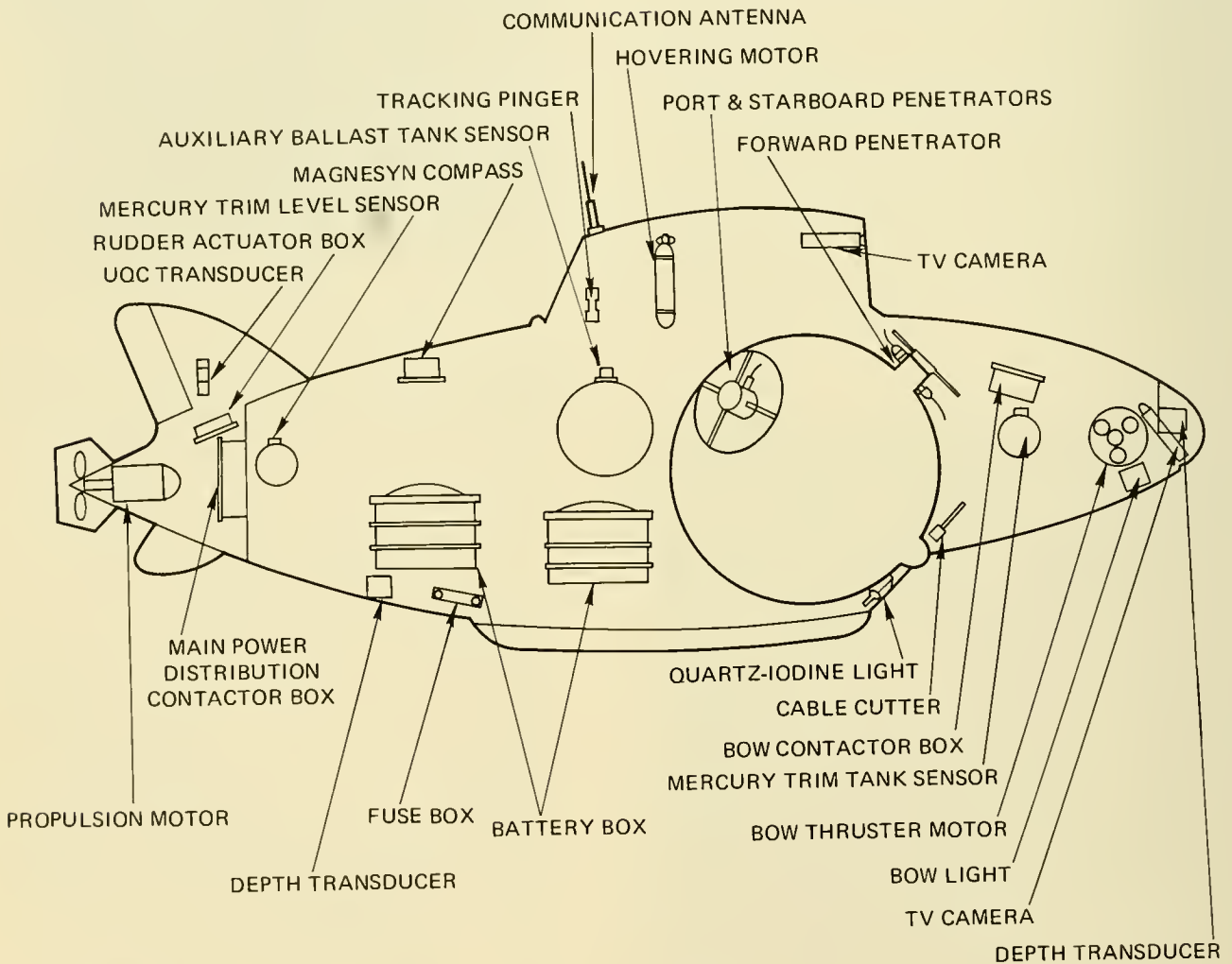

Fig. 7.36 Outboard electrical components.

Mr. G. Pallange (Lockheed Missiles and Space) in November 1968.

Obviously, the first order of business for the circuit designer is to identify and ascertain the electrical characteristics of the components (inboard and outboard of the pressure hull) the power source will serve. Table 7.8 presents a listing of voltage and amperage requirements of one set of outboard submersible components and was taken from reference (31). A graphic representation of some components in this list is shown in Figure 7.36 on the *STAR III*; also taken from the same source. To demonstrate the "untypical" nature of the component array shown in Figure 7.36, the *VAST* or *K-250* series of shallow vehicles (see Chap. 4) has only its propulsion motors outboard. Other vehicles, e.g., the *DSRV*'s, have several times more than the 25 shown in this figure. Nonetheless, with the information presented in Table 7.8, the designer is in a position to develop a

schematic for both internal and external distribution as shown in Figure 7.37.

The DOT Handbook (31) offers several considerations regarding the general distribution system; in part, these are:

- Identify and classify thru-hull conductors to expedite location and eliminate cross coupling.
- Examine load levels (high, low, etc.) to ascertain their potential for electromagnetic interference. (This topic is dealt with in more detail in the following section.)
- The metallic parts of the vehicle should not be used to carry electrical power (i.e., as a ground), thus, power sent out on one conductor must return on another. In this respect Pallange recommends that switching, isolation and protective functions be performed on all wires concerned with the circuit.

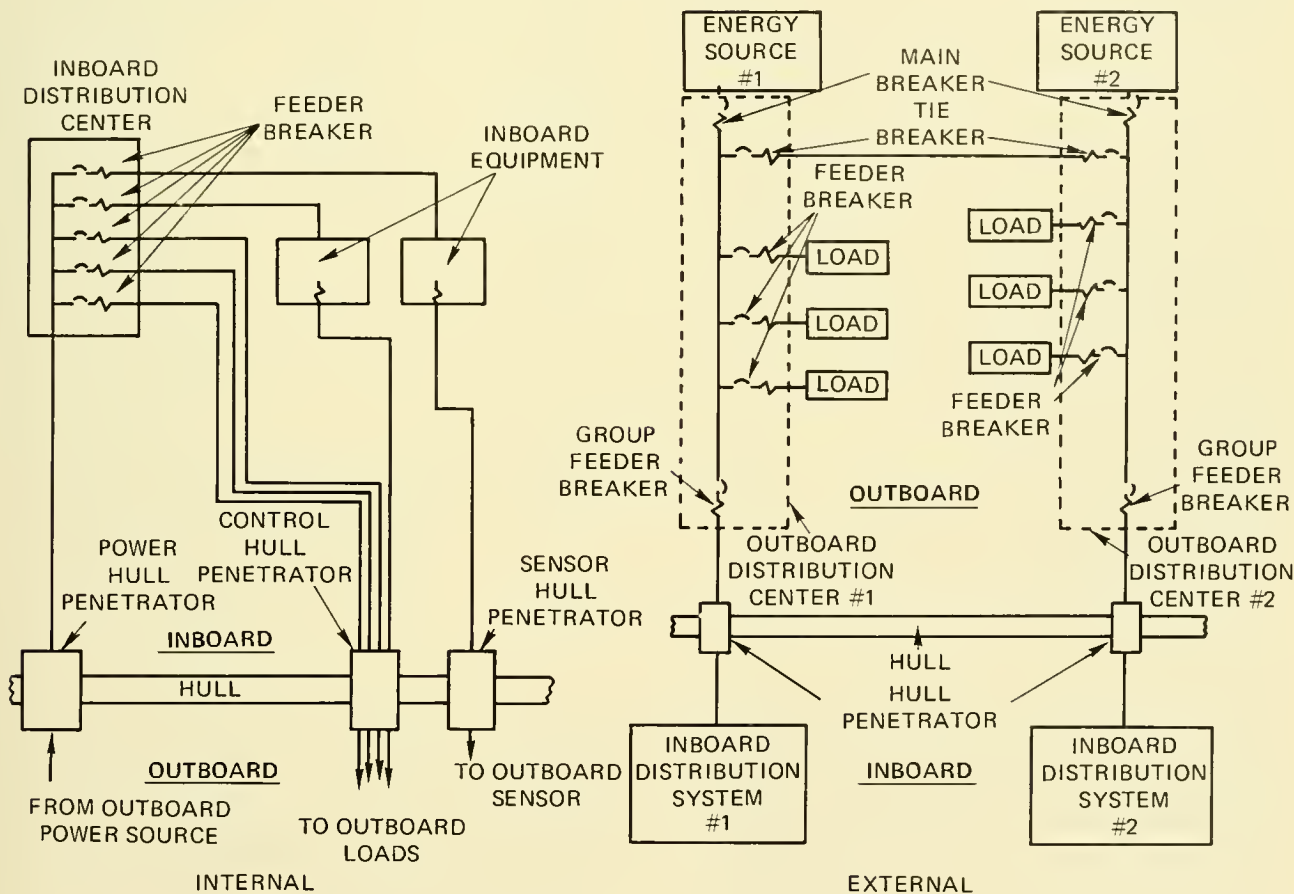

Fig. 7.37 External and internal schematics of power distribution systems.

TABLE 7.8 TYPICAL VOLTAGE AND AMPERAGE REQUIREMENTS  
FOR OUTBOARD COMPONENTS ON SUBMERSIBLES

Typical Basic Component Group	Notes	Number of Conductors Required	Typical Values		Recommended Connector Size
			Volts	Amps	
<b>MOTORS</b>					
Main Hydraulic Plant	1	2/2/1	60/60/12	60/2/<1	3 NO. 4 – 3 NO. 16
Auxiliary Hydraulic Plant	2	2/2/1	60/60/12	110/3/<1	3 NO. 0 – 3 NO. 16
Pod Propulsion	3	2/2/1	60/60/12	85/6/<1	3 NO. 4 – 3 NO. 16
Pod Training	4	2/2/1	60/60/12	25/1/<1	3 NO. 12 – 3 NO. 16
Main Propulsion	5	2/2	120	20	3 NO. 12 – 3 NO. 16
Ext. Hydraulic Pump	6	3/2	440/10	15/<1	5 NO. 16
Thruster	7	3/2	440/10	20/<1	3 NO. 12 – 3 NO. 16
Main Propulsion	8	3/2	440/10	45/<1	3 NO. 8 – 3 NO. 16
Main Seawater Pump	9	6/2	440/10	15 <1	3 NO. 16 – 3 NO. 16
Main Propulsion	10	2/2/2	120/240/120/10	15/25/2/<1	3 NO. 12 – 5 NO. 16
Vertical Thruster	11	2/2/2	120/120/10	15/2/<1	9 NO. 16
<b>CAMERAS</b>					
Remote Operated TV	1	4 + 75Ω Coax	12 VDC	<1	5 NO. 20 – 75Ω Coax
Remote Operated TV	2	6 + 75Ω Coax	12 VDC	<1	10 NO. 20 – 75Ω Coax
Remote Operated Still	3	3	30 VDC	14 (Peak) <1 (Avg.)	3 NO. 16
Remote Operated Still	4	9	30 VDC	14 (Peak) <1 (Avg.)	9 NO. 16
Still Camera Strobe	5	3	30 VDC	14 (Peak) <1 (Avg.)	3 NO. 16
Remote Operated Camera Pan and Tilt Mechanism	6	5	115 VAC	1	5 NO. 20
Remote Operated Camera Pan and Tilt Mechanism	7	13	115 VAC	1	14 NO. 16
Remote Operated Camera Pan and Tilt Mechanism	8	10	30 VDC	5	14 NO. 16
<b>COMMUNICATIONS &amp; SONAR</b>					
Underwater Telephone	1	See Note	See Note	1	3 NO. 16
Intercom Telephone	2	See Note	See Note		3 NO. 16
Radio Telephone Whip Ant.	3	Single Coax	See Note	<1	50 Ω Coax
CTFM (Continuous Transmission Frequency Modulated) Sonar	4				
Training Mechanism	5	12	115 VAC	1	
Transmitting Hydrophone	6	See Note	500V, P-P	<1	5 NO. 20
Receiving Hydrophone	6	See Note	10V, P-P	<1	3 NO. 16
Sonar Echo sounder	7				
Pressure Hull To Transmitter Can		6	30 VDC	1	
Transmitter Can To Hydrophone	6	See Note	500V, P-P	<1	3 NO. 16
Doppler Navigator Sonar					
Transmitting Hydrophone	8	See Note	500V, P-P	<1	5 NO. 20
Receiving Hydrophone	9	See Note	10V, P-P	<1	10 NO. 20

LIGHTS

Underwater Floodlamps					
Mercury Vapor	1	3	110 VAC	10	3 NO. 16
Tungsten - Iodide	1	2	110V, AC/DC	10	3 NO. 16
Tungsten - Iodide	2	2	110V, AC/DC	5	3 NO. 16
Tungsten - Iodide	3	2	228V, AC/DC	1	3 NO. 16
Tungsten - Iodide	4	2	30V, AC/DC	25	3 NO. 12
Navigation Running	7	2	110V, AC/DC	1	3 NO. 16
Identification Flashing					
Beacon	5	2	110 VAC	1	3 NO. 16
Strobe, Photographic	6	4	28 VDC	14 (Peak)	5 NO. 16

MISCELLANED US

Anchor Payout Solenoid		2	110 VAC	1	3 NO. 16
Ballast Release Solenoid		2	60 VDC	1	3 NO. 16
Single Motion Actuator					
For Various Equipments		2	30 VDC	3	3 NO. 16
For Various Equipments		2	60 VDC	1	3 NO. 16
For Various Equipments		2	110 VAC	1	3 NO. 16
Mechanical Arm (Manipulator)	1				
Open Loop Control		62	24 VAC/DC	1	24 NO. 16
Closed Loop Control		74	24 VAC/DC	1	24 NO. 16
Emergency Guillotine	2,3	2 + 2	30 VDC	See Note	5 NO. 20

TRANSDUCER CIRCUITS

Seawater Leak Sensing Probe					
Shaft Tachometer		Generally		These Probes Are	
Pressure		Twisted Pair,		Usually Powered	
Temperature		Shielded. May		From The Inboard	
Salinity		Have Special		Device They Are	5 NO. 16 or 5 NO. 20
Rudder Angle		Requirement		A Part Of.	
Dive Plane Angle		Depending on		Typical Values	
Propulsion Pod Angle		Application		Are Currents In	
Ammeter Shunts		And/Or		Milliamperes And	
Voltmeter Leads		Manufacturer		Voltages Less Than 10.	

NOTES AND COMMENTS TO TABLE 7.8

NOTES: (MOTORS)

1. DC Shunt, Armature/Field/Seawater Leak Probe; 3 hp
2. DC Shunt, Armature/Field/Seawater Leak Probe; 6.8 hp
3. DC Shunt, Rev., Field Control; Arm/Field/Probe; 4 hp
4. DC Shunt, Rev., Arm/Field/Probe; 1.5 hp
5. DC Series, Rev., Pulse Width Speed Control;
6. 3φ AC, Motor Power/Tachometer

—With AC circuits a two-or-three conductor path twisted pair is the best available configuration to cancel the alternating magnetic field from each conductor. Magnetic and electrostatic shielding may also be required. Physical separation of conductors to reduce alternating fields would be almost impossible.

—Inductive loads on DC power require special switch and circuit breaker considerations. Separation of conductors could possibly make a normally resistive load inductive. If the conductors were separated by several feet, a single turn loop of considerable area and significant inductance could be formed, but the loop

NOTES AND COMMENTS TO TABLE 7.8 (Cont.)

7. 3 $\phi$  AC, Rev., Speed Control By Variable Voltage; Motor Power/Tach.
8. 3 $\phi$  AC, Rev., Speed Control By Variable Frequency; Motor Power/Tach.
9. 3 $\phi$  AC, 2-Speed, By 2 Winding Sets; 2 or 10 ph; Motor Power/Tach.
10. DC – Shunt, Rev., Speed Control By Arm. Volts And/or Field; Arm/Field/Tach.
11. DC – Shunt, Rev., Speed Control By Field Resist; Arm/Field/Tach.

NOTES: (CAMERAS)

1. Remotely Controlled Focus
2. Remotely Controlled Focus, ZOOM, and Iris
3. Remotely Controlled Trigger Function Only; 14 Amp Max. Recharge; 3 Sec Recycle
4. Remotely Controlled with Trigger, Iris Focus, and Shutter Special Optical
5. Remotely Controlled Trigger Function
6. PAN And TILT Functions Only
7. With Additional Options: Orientation and Limit Indicators
8. DC Operated Option With Stepping Motors; 5 amp Peak Current During Stepping Pulse.

NOTES: (COMMUNICATIONS & SONAR)

1. Cable Usually Twisted Pair With Shield; Volts About 950 Peak to Peak On Audio Peaks
2. Cable Usually Twisted Pair With Shield; Volts About 10 Peak to Peak on Audio Peaks
3. Voltage Typically 150 Peak To Peak (Radio Frequency) With 50 ohm System.
4. Side Scan Or Obstacle Avoidance
5. 3 Cables; 4 Conductors Each
6. Twisted Pair With Shield
7. BETHOS 2670; With Outboard Transmitter Can and Hydrophone
8. 3 Conductors, Shielded; TTS4 SHL Recommended
9. 4 Shielded Pairs; TTRS4 SLL Recommended

NOTES: (LIGHTS)

1. 1000 Watts
2. 500 Watts
3. 75 Watts
4. 750 Watts
5. For Larger Vehicles With AC As Main Source, Smaller Vehicles Utilizing Battery Power Generally Use a Self-Contained, Pressure Activated Flasher.
6. Usually Supplied with 4 Terminal Underwater Connector; 14 amp Peak Recharge Current After Flash.
7. These Lights Usually Originate From Support Vessel and Are Removed For Diving.

NOTES: (MISCELLANEOUS)

1. Electrically Controlled Hydraulic Powered Operators
2. Emergency Devices Usually Have Dual, or Redundant Functions For Safety.
3. Explosive Operated Devices Require 30 amp Pulse, Low Resistance Circuit.

Projected Future Electrical Requirements Are Covered By:

3 #0000 – For Propulsion Motor and Battery Connectors.

Single Contact

#16, 12, 8, 4, 0 and 0000 – For Applications Where Single Conductor Cables Are Used Outboard or Are Projected For Future Use.



could prove to be most troublesome during switching operations and, in addition, would generate a substantial magnetic field which could be fatal for other devices, such as magnetic compasses and magnetometers.

—Another area sometimes overlooked is the desirable separation of conductors capable of carrying high level fault currents from conductors attached to explosive-operated devices. A high fault current could possibly induce a firing current in the explosive squib and could prematurely activate some system.

The foregoing considerations define the tasks involved in the power distribution design. In general, the following recommendations are offered for these applications:

—The connector or hull penetrator must have a power rating in excess of the maximum fault current which may flow through the respective circuit as limited by circuit protective devices.

—On all DC power circuits each polarity should be taken through separate connectors or penetrators.

—AC power circuits, especially three-phase 440 VAC, for example, should be carried through a single nonmagnetic penetrator or connector. Before attempting to separate these conductors into separate penetrators or connectors, a hard look would have to be taken at the inductive heating effects of these conductors separated by magnetic materials, since detrimental, or even destructive, heating of these materials could occur. If nonmagnetic materials are used in the magnetic field between conductors, the heating effect would be greatly reduced. However, eddy current heating in any electrically conductive material would still remain a possibility.

—Circuits susceptible to noise or interference should not be routed through a connector or penetrator which carries power and control circuits.

Regarding external distribution specifically, the importance of connectors (between energy source and external distribution box) capable of carrying the maximum fault current generated by the energy source is emphasized. The group feeder breakers (Fig. 7.37) provide added connector protection be-

tween the external distribution center and the vehicle and the hull penetrator. In selecting suitable sensing devices on the tie and feeder breakers, the rating of the connectors used in these areas must be sufficient to handle the maximum fault amperage which may flow prior to tripping a particular breaker. The DOT Handbook further cautions that penetrators through the hull should be protected by circuit protective devices to reduce the possibility of damage.

As an aid in providing design guidelines, component specifications and selection criteria for circuit interruption devices, the DOT Program undertook to produce reference (45), the emphasis of which is almost entirely on the use of on-off mechanical contactors in pressure-compensating fluids. The author, Pocock, states that subsequent editions will include additional chapters on circuit breakers, solid state circuit interrupting devices and fuses.

## INSTRUMENT INTERFERENCE

A great proportion of the instruments on contemporary submersibles are electronic and thus susceptible to electric interference which can degrade their performance by blanking out data or generating erroneous data. Many of the instruments may be classed as electroacoustic, which are also subject to acoustic interference. Regarding this problem, Mr. K. R. Haigh of the Admiralty Experimental Diving Unit, Portsmouth, states (46):

*“The presence, origin and nature of electrical and acoustical interference in the majority of current submersibles has received scant attention from the owners and operators with the result that many users have been unable to realize the full potential of the boat in its scientific or survey role.”*

Haigh further reflects that such interference is not a new problem but is one that has been solved before in military submarines, and he attributes its existence in submersibles to lack of dissemination or suppression methods to civilian submersible builders. To appreciate that such interference can be a

severe problem, one has merely to glance at Figure 7.38 which shows portions of a side scan sonar record from *ALUMINAUT*. Virtually every electronic component aboard the vehicle, including the scientific instruments themselves (stereo camera system), produced an interference pattern on the record which partially or completely obliterated the returning echoes from the sonar's transducers. *ALUMINAUT* is not alone in this problem; to a greater or lesser degree all submersibles exhibit electrical and/or acous-

tic interference. Because this problem has such an impact on the scientific and surveying potential of submersibles, its nature and the means of suppression, as discussed by Haigh, are summarized in some detail.

Acoustic sources of interference may be mechanical, hydraulic or pneumatic in origin. These are considered so basic as to constitute design error. The chief consideration, therefore, is given to other types of acoustical as well as magnetic and electrical interference. Figure 7.39 presents their origin and nature.

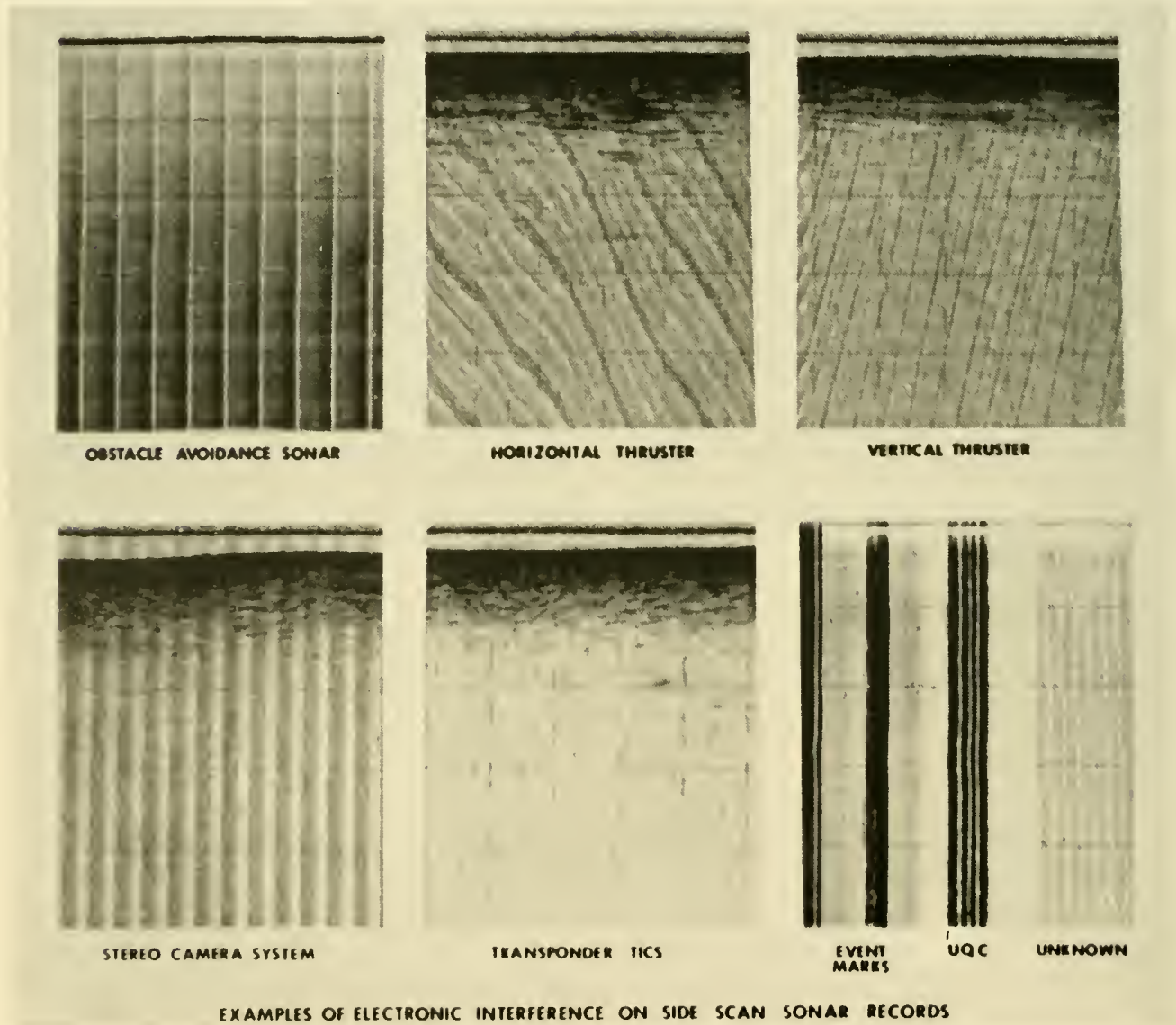

Fig. 7.38 Examples of electronic interference on side scan sonar records. (NAVOCEANO)

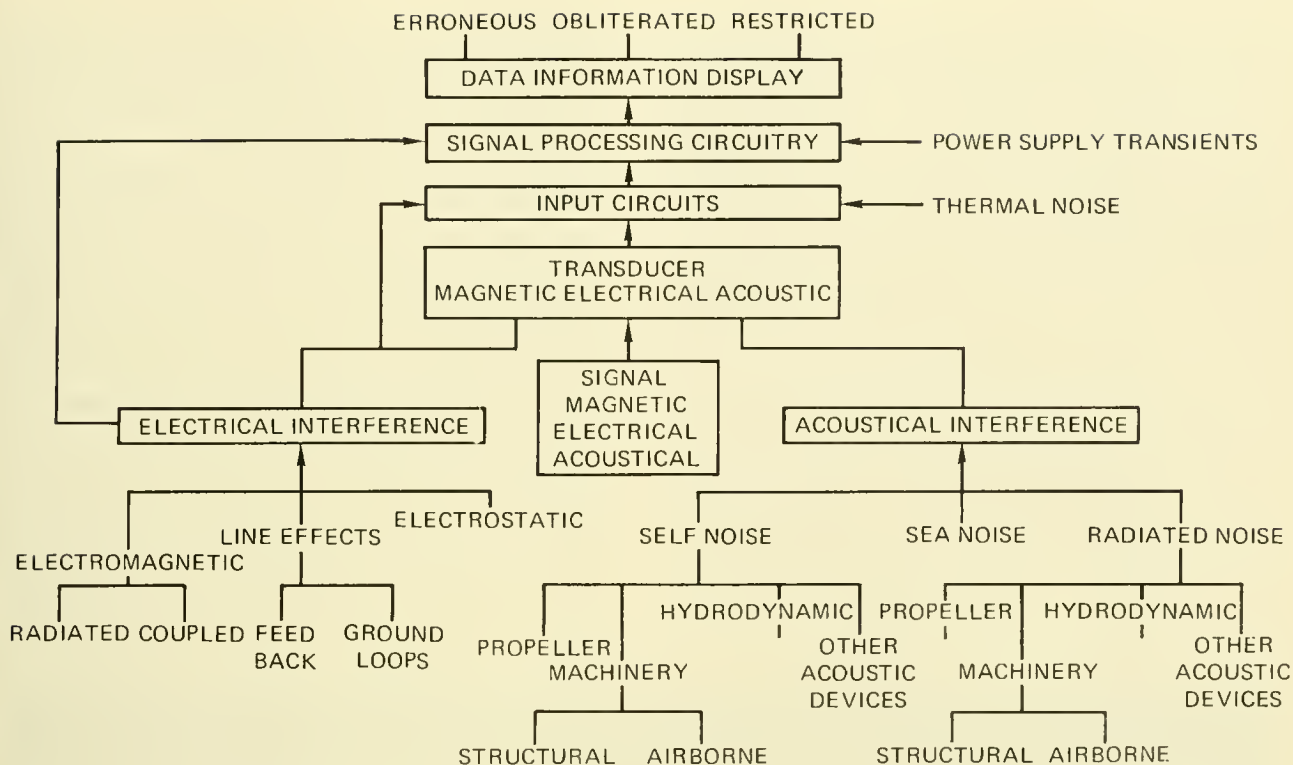

Fig. 7.39 Origin and effects of acoustical and electrical interference. [From Ref. (45)]

### Acoustic Interference

Three types of acoustical interference can find their way into signal circuits and consequently lower the signal-to-noise ratio: Sea Noise, Self Noise and Radiated Noise.

#### a) Sea Noise:

In an acoustical system free of other noise sources, sea noise is the background against which signals must be detected. The origin of the noise may be due to thermal agitation of the water molecules, seismic activity, surface and sub-surface traffic and sea surface motion which is dependent on wind speed. In coastal waters additional contributions are received from waves breaking on the shoreline, turbulence around obstructions and noise from marine life. Because sea noise is always present and must be accepted, Figure 7.40 is taken from Haigh's report and indicates the background sea noise for various sea states; these levels are expressed in a 1-Hz bandwidth so they must be increased by 10-log bandwidth to arrive at the interfering pressure level.

#### b) Self Noise:

Self Noise is that produced by the vehicle itself (propellers, machinery, hydrodynamic) and picked up in its own transducers or hydrophones. The submersible user should also be aware that noise from its own support ship can also be detrimental to functions such as communications and tracking and must also be considered.

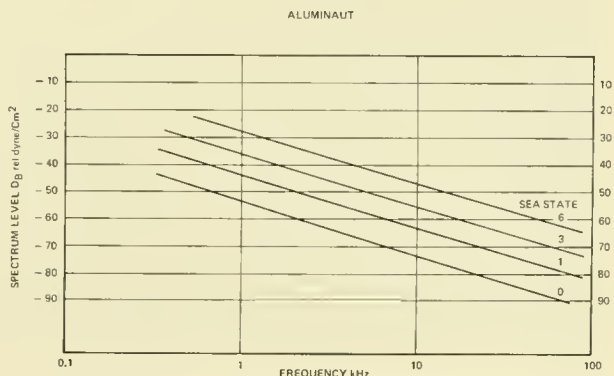

Fig. 7.40 Background sea noise under various sea state. [From Ref. (45)]

- 1) **Propeller Noise** —Noise produced by the collapse of bubbles created by the propeller rupturing (rotating in) the water. The point of inception of cavitation depends on propeller speed and depth. Generally, submarines have small, high speed propellers and cavitation sets in at slow vehicle speeds; however, the effect of depth is to reduce the point of inception and to move the noise spectrum toward the higher frequencies.
- 2) **Machinery Noise** —Noise emanating from machinery and transmitted through the structure induces pressure waves. Unless precautions are taken reciprocating and rotating machinery of any type will produce vibrations which can be transmitted to the hull structure. Electrical transformers and chokes can also produce structural vibrations. Structural vibrations can be minimized by mounting all rotating and vibrating machinery on rubber mounts and ensuring that there is no mechanical coupling between the machine and the structure. In hydraulic and pneumatic systems this entails the use of flexible pipe couplings, while in electrical circuits no conduits should be firmly secured to both the machine and hull.
- 3) **Hydrodynamic Noise** —Noise originating from the flow of water across the face of a hydrophone or turbulence around some protuberance on the vessel. At the slow speeds of submarines this should not be a problem, except perhaps in those vehicles propelled by water jets.

**c) Radiated Noise:**

The sources of radiated noise are identical to those of self noise and the cure in many cases is the same. If radiated noise is present to any extent it may be assumed that the vessel has self noise problems.

**Electrical Interference**

Electrical interference is of three types: Electromagnetic, line effects and electrostatic. All can be induced directly or indirectly into signal processing circuits and

must be suppressed to a level less than that of sea noise, which is considered the practical background against which sensors operate.

**a) Electromagnetic Interference:**

When currents pass through conductors, magnetic and electrical fields are formed around the conductors as in Figure 7.41. The magnitude of interference depends upon field strength, field geometry, the rate of change of field and frequency and the susceptibility of the receiving circuit. Haigh divides electrical interference into radiated and coupled. The difference is slight and resides merely in the physical separation of the transmitting and receiving elements. Coupled interference is characterized in Figure 7.41a as both magnetic and electric radiation between two cables running side by side or between cores in a multi-core conductor. Conventional cable shielding methods can contain the electric field as shown in Figure 7.41b, but either exotic shielding or complete separation of power supply cables

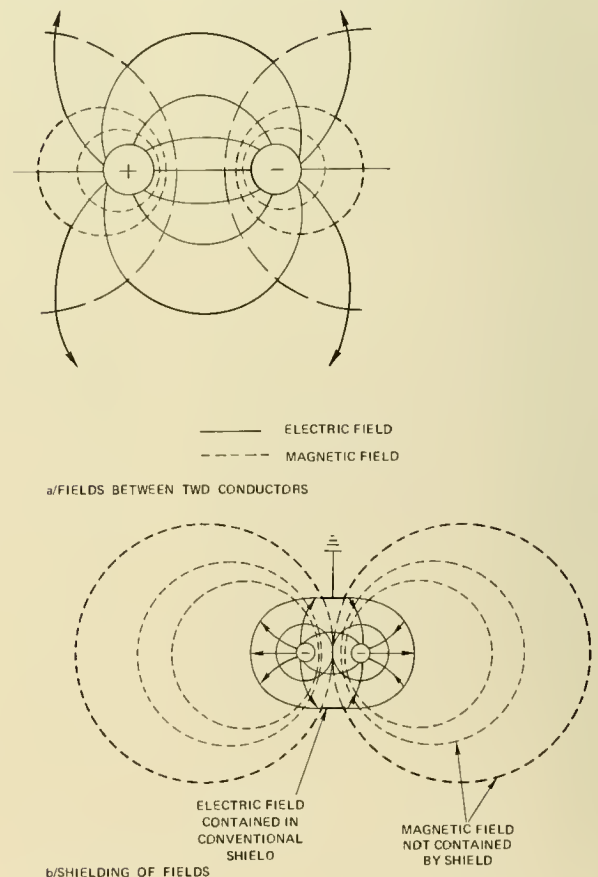

Fig. 7.41 Electromagnetic radiation (a), and the effects of conventional shielding (b).

from sensitive instrument circuits is required to isolate electromagnetic fields. Sources of radiated interference include transformers, inductors and cables operating at frequencies from zero to the radio communication spectrum. Other sources are inverters, converters (DC to DC), and fluorescent lighting. Protection includes encasing low level cables in solid drawn steel conduits, as well as conventional shielding. An example of one source of coupled interference is shown in Figure 7.42 wherein the close proximity of cables seems to make such interference inevitable. Further problems with such a layout is that of identifying various cables and protecting them from physical destruction.

**b) Line Effects:**

These encompass unexpected tuning effects of cables and associated equipment which cannot be completely anticipated in the design stage and arise during installation and the effects of grounding upon interference suppression. Haigh separates these into feedback and ground loops and suggests various remedies, *e.g.*, filters and grounding, to ameliorate their effects.

**c) Electrostatic Interference:**

Electrostatic interference arises chiefly from the movement of cables or machinery rubbing against cable sheaths. Should the submersible be concerned with towing a low level sensor, or derive its power from a surface umbilical, then the action of the cable



Fig 7.42 ALUMINAUT's internal junction boxes. (NAVOCEANO)

strumming under tension can give rise to friction in the insulation and the creation of an electrostatic field. This problem may be overcome by using a cable insulant loaded with a small amount of graphite.

The subject of eliminating or suppressing the interference discussed above is dealt with in greater detail in the DOT Handbook on Cable Technology (44); the designer is referred to this and Haigh's work for a thorough and comprehensive review.

## REFERENCES

1. Cohn, P. D. & Wetch, J. R. 1969 *Power Sources*. in *Handbook of Ocean and Underwater Engineering*. McGraw-Hill Book Co., N.Y., p. 6-2 thru 6-32.
2. Rynewicz, J. F. 1970 *The submersible DEEP QUEST. A step forward in Offshore Technology*. Offshore Tech. Conf., of 22-24 April 1970, Houston, Tx., Paper No. OTC 1199.
3. Louzader, J. D. & Turner, G. F. 1966 *Power under the sea*. Trans. Mar. Tech. Soc. Conf., *Exploiting the Ocean*. p. 424-433.
4. Bodey, C. E. & Friedland, N. 1966 *Naval architecture of submarine work boats for offshore work*. Proc. of Ocean Exploration Conf., 1966, p. 105-119.
5. Panel on Energy Sources, Committee on Undersea Warfare, National Research Council 1968 *Energy Systems Endurance in the 1-100 Kilowatt Range for Undersea Applications*. Nat. Acad. Sci. Pub. 1702, Wash., D.C., 132 pp.
6. Penzias, W. & Goodman, M. W. 1973 *Man Beneath the Sea*. Wiley-Interscience. John Wiley & Sons, Inc., N.Y., 831 pp.
7. Howard, P. L. 1964 *A novel technique for predicting battery performance*. Product Eng., 26 Oct., 8 pp.
8. Kisinger, W. W. 1965 *Propulsion of deep diving submersibles*. Naval Eng. Jour., Aug., p. 573-584.
9. Horne, R. A. 1963 *The operation of batteries at great ocean depths*. Undersea Tech., July, p. 16-18.
10. Yeaple, F. D. 1965 *Dry Cell performance*. Prod. Eng.
11. Work, G. W. 1969 *Battery Materials and Characteristics—Effects of the Deep-Sea Environment on Materials Performance and the Deep Sea*. ASTM STP 445, Amer. Soc. of Testing and Materials, p. 31-40.
12. Funao, Y., Nakamura, K., Kawai, I. & Hosoi, S. 1972 *Oil-filled silver-zinc secondary battery for deep submersible*. Preprints 2nd International Ocn. Dev. Conf., Oct. 5-7, 1972, Tokyo, v. 1, p. 853-869.
13. Momsen, D. F. & Clerici, J. 1971 *First silver-zinc batteries used in deep submergence*. Mar. Soc. Tech. Jour., v. 5, n. 2, p. 31-36.
14. Work, G. W. 1972 *Batteries for deep ocean application*. Preprints 8th Ann. Conf. & Exhibition, Mar. Soc. Tech. Jour., v. 5, n. 2, p. 31-36.
15. Anderson, A. G., Wright, C. P. & Newman, J. P. 1970 *Capsulating energy systems for small submersibles*. 2nd Ann. Offshore Tech. Conf., Houston, Tx., April 22-24, 1970, Paper No. OTC 1164.
16. Evans, R. S. 1968 *Compensation for outboard batteries on research submarines*. Trans. Mar. Tech. Soc. 1968, *A Critical Look At Marine Technology*, p. 643-649.
17. Marriott, J. A. & Capotosto, A., Jr. 1968 *The gassing behavior of lead-acid storage batteries in oil compensated systems. I. Studies at atmospheric pressure*. Trans. Mar. Tech. Soc., *A Critical Look At Marine Technology*, p. 651-660.
18. ———— 1968 *The gassing behavior of lead acid storage batteries in oil compensated systems. II. Studies at elevated hydrostatic pressures*. *Ibid.*, p. 661-670.
19. Miron, D. B. & Evans, R. S. 1966 *Analysis and Specification Compensation Volume and Parameters for AUTECH Vehicles External Battery Systems*. Gen. Dyn./Elec. Boat Rept. U413-131.
20. McQuaid, R. W. & Brown, C. L. 1969 *Handbook of Fluids and Lubricants for Deep Ocean Application*. NSRDC Pub. MATLAB 360, 176 pp., revised 1972.
21. Loughman, R. & Butenkoff, G. 1965 *Fuel Cells for an underwater research vehicle*. Undersea Tech., Sept. 1965, p. 45-46.
22. Anderson, A. G. 1970 *Summary of a presentation on "PROJECT POWERCEL"*. Trans. Mar. Tech. Soc. 1970, v. 2, p. 1103-1109.

23. Warszawski, B., Verger, B. & Dumas, J. 1971 *Alsthom fuel cells*. Mar. Tech. Soc. Jour., v. 5, n. 1, p. 28-40.
24. McCartney, J. F. 1970 *Hydrospace fuel-cell power systems*. Trans. Mar. Tech. Soc. 1970, v. 2, p. 879-907.
25. Cohen, S. & Wallman, H. 1970 *Engineering evaluation of the applicability of fuel cell systems to deep submersibles*. Trans. Mar. Tech. Soc. 1970, v. 2, p. 1401-1423.
26. Fukunaga, P. R. & Pearson, R. O. 1971 *Closed-Cycle Power Systems For Undersea Military Facilities and Equipment*. Prepared for the U.S. Naval Civil Engineering Laboratory, under contract N62399-71-C-0027 to TRW Systems Group.
27. Giorgi, E. 1968 *Underwater power systems*. Jour. Ocean Tech., Mar. Tech. Soc., v. 2, n. 4, p. 57-117.
28. Watson, W. 1971 *The design, construction, testing, and operation of a deep-diving submersible for ocean floor exploration*. Trans. of the Ann. Meeting of the SNAME, 11-12 Nov. 1971, N.Y., p. 405-437.
29. Sasaki, T. 1970 *On underwater observation vessels in Japan*. Trans. 6th Ann. Conf. & Exhibition Mar. Tech. Soc., 29 June-1 July 1970, Wash., D.C., v. 1, p. 227-237.
30. Hoffman, L. C., Rudnicki, M. I. & Williams, H. W. 1970 *Psychrocycle*. Mar. Tech. Soc. Jour., v. 4, n. 6, p. 47-56.
31. U.S. Naval Ship Engineering Center 1971 *Handbook of Vehicle Electrical Penetrators, Connectors and Harnesses of Deep Ocean Applications*. Deep Ocean Tech. Program, Hyattsville, Md.
32. "Meeting on Cables, Connectors and Penetrators," text of presentations and general discussion held at Deep Submergence Systems Project Office, Bethesda, Md., 15-16 Jan. 1969.
33. Haigh, K. R. 1968 *Deep-sea cable-gland system for underwater vehicles and oceanographic equipment*. Proc. IEE, v. 115, n. 1, p. 153-157.
34. Tuttle, J. D. 1971 *Underwater electrical integrity*. Preprints 7th Ann. Conf., Mar. Tech. Soc., 16-18 Aug. 1971, Wash., D.C., p. 135-145.
35. Walsh, D. K. 1966 *Underwater electrical cables and connectors engineered as a single requirement*. Exploiting the Ocean, Mar. Tech. Soc., p. 469-484.
36. Department of the Navy, Deep Submergence Systems Office 1969 *Meeting on Cables, Connectors and Penetrators for Deep Sea Vehicles*, 15-16 Jan. 1969, 383 pp.
37. Small, F. B. & Weaver, R. T. 1971 *Underwater disconnectable connector*. Preprints Mar. Tech. Soc. 7th Ann. Conf., 12-18 Aug. 1971, Wash., D.C., p. 125-133.
38. Haworth, R. F. & Regan, J. E. 1964 *Watertight electrical connectors for undersea vehicles and components*. Ann. Winter Meeting ASME, N.Y., Nov. 29-Dec. 4, 1964, Paper 64-WA/UNT-10, 12 pp.
39. ——— 1965 *Watertight electrical cable penetrations for submersibles—past and present*. Ann. Winter Meeting ASME, N.Y., 7-11 Nov. 1965, Paper 65-WA/UNT-12, 8 pp.
40. Haworth, R. F. 1966 *Electrical cable system for the STAR III vehicle*. Ann. Winter Meeting and Energy Systems Expo ASME, N.Y., 27 Nov.—1 Dec., 1966, Paper 66-WA/UNT-11, 5 pp.
41. O'Brien, D. G. 1967 *Application of glass-hermetic-sealed watertight electrical connectors*. Mar. Tech. Soc. 3rd Ann. Conf. and Exhibit, San Diego, Calif., 5-7 June 1967, p. 667-705.
42. Patterson, R. 1969 *Electrical connectors—the weakest link?* Oceanology International, Jan/Feb 1969, p. 40-43.
43. Saunders, W. 1972 *Pressure-compensated cables*. Preprints Mar. Tech. Soc. 8th Ann. Conf. and Exhibition, 11-13 Sept. 1972, Wash., D.C., p. 23-38.
44. Forbes, R. T., Delucia, M. A. & Behr, S. H. 1970 *Handbook of Electric Cable Technology for Deep Ocean Application*. U.S. Naval Ship Research and Development Laboratory, Annapolis, Md., 24 pp.
45. Pocock, W. E. 1971 *Handbook of Electrical and Electronic Circuit Interrupting and Protective Devices for Deep Ocean Application*. U.S. Naval Ship Research and Development Center, Wash., D.C., 74 pp.

46. Haigh, K. R. 1970 *Instrumentation interference in submersibles*. Preprints 6th Ann. Conf. and Expo. Mar. Tech. Soc., 29

June—1 July 1970, Wash., D.C., v. 2, p. 1189-1201.





# 8

## MANEUVERABILITY AND CONTROL

The ability of submersibles to maneuver and the means of controlling or directing them undoubtedly represent the widest design departures from the military submarine. *BEAVER* was designed to work primarily on engineering tasks. Therefore, the basic requirements were for tightly-controlled, small scale movements which could place it in a position to employ its tool kit while hovering and maintaining a constant position in midwater. *DEEP QUEST* was intended for various tasks: It could range about for moderate distances, maneuver adroitly and, if required, assume virtually any attitude necessary to mate with an undersea object. Vehicles of the *BEN FRANKLIN* and *ALUMINAUT* variety were survey-

ors in the fashion of Lewis and Clark. They could range over long distances, maneuver to pick up large quantities of samples and carry a vast array of equipment. Smaller submersibles, such as *SP-350*, Perry's *CUBMARINEs* and General Oceanographic's *NEKTONs*, were designed for short duration scrutinizing and sampling in narrow canyons and along steep cliffs, as well as cruising along flat or gently sloping surfaces.

One of the more ingenious and imaginative aspects of manned submersibles is the variety of approaches taken to achieve the desired maneuverability. Virtually all have obtained a high degree of maneuverability with only a handful following similar approaches. Within this chapter the means employed to

propel, maneuver and control submersibles is reviewed. No attempt is made to categorize the various approaches, because the extreme variation from vehicle-to-vehicle defies classification.

There is one general statement regarding submersible propulsion which can be made: They are all slow and they all use electric power. Although it may be satisfying in a literary sense, no submersible "darts about" or "speeds off" on its appointed rounds. As Cousteau so aptly stated in *The Living Sea*, "Speed is the enemy of observation." This philosophy has been adopted by submersible designers. Averaging the cruising speed of 80 submersibles produces a value of 1.5 knots, with a range from 0.2 knot (*FNRS-2*) to 6 knots (*AUGUSTE PICCARD*). One and a half knots is equivalent to a casual stroll, and this has been quite acceptable to the undersea scientist and engineer. The only need for higher speed appears to be on the part of the pelagic fisheries' biologist who desires to observe the migration and behavior of fast swimming fish, such as tuna. To this end General Dynamics conducted a feasibility and conceptual design study of a research submarine for the Department of Interior's Bureau of Commercial Fisheries (now the National Marine Fisheries Service) and recommended a maximum submerged speed of 20 knots. Nothing further has evolved from this study, which was completed in 1965 (1).

In the submersible field the term maneuverability has a variety of meanings; it refers, not only to the vehicle's ability to twist or turn, but also implies its ability to climb, hover and poke around in close quarters. The requirements for maneuvering at times can be quite severe—on a surveying mission, for example, where ascent (at a constant height of 10–30 feet above the bottom) from several thousand feet deep to a hundred feet or less may be required. The submersible must be able to "fly" horizontally, then assume an up-bow angle of 30 or more degrees and finally ascend vertically while maintaining a position some 2 or 3 feet away from the face of a vertical escarpment. Such requirements are not hypothetical; *ALUMINAUT* confronted just this problem while bottom surveying off Vieques Island, Puerto Rico and St. Croix, U.S. Virgin Islands, in 1967 and

1968. *ALVIN* confronted similar problems in the Tongue of the Ocean, Bahamas in 1966 and 1967. These are but a few examples. Other submersibles faced and continue to face equally taxing demands on their maneuverability and control. The problem is not too different from those of a helicopter. While ocean bottom currents do not nearly approach the wind speeds encountered by a helicopter, submersible power plants are so much less than a helicopter's that the problems are quite comparable.

The topics of marine propulsion and hydrodynamics are subjects which comprise books in themselves. Their terminology and principles are multitudinous and complex. Herein, discussion is confined to the minimum of terms and principles needed to describe the motions of a submersible and the devices and physical phenomena which propel and direct it through the water. In the event that a more thorough or technical treatise is desired, the following are recommended:

- a) "*Marine Propulsion*" (2): A historical and semi-technical presentation which describes and illustrates the development of marine propulsion throughout the ages.
- b) "*Stability and Motion Control of Ocean Vehicles*" (3): A very thorough and highly technical discussion of the hydrodynamic principles involved in designing vehicles and systems and determining their response to the environment. This publication was written as a "partial" text on the subject of motion and control of ocean vehicles offered by the Department of Naval Architecture and Marine Engineering at the Massachusetts Institute of Technology.
- c) "*Naval Hydrodynamics*": A series of seven publications from 1957 through 1968 presenting the reports of international scientists and engineers regarding marine propulsion, cavitation, noise, hydroelasticity, motions, drag and other aspects of marine propulsion. The contents of these books are quite technical, comprehensive and far ranging. A listing of the books and their contents can be obtained from the National Technical Information Service, Operations Division, Springfield, Virginia 22151.

- d) **“Water, Air and Interface Vehicles”** (4): Similar to reference (3) in purpose and technical detail, this publication discusses hydrodynamic forces and propulsion for airborne and waterborne vehicles on a common plane.
- e) **“Principles of Naval Architecture”** (5): A textbook which covers all static and dynamic aspects of naval architecture, both theoretical and applied. The book concentrates on merchant ships, but includes discussion of submarine hydrodynamics and design. A knowledge of calculus, applied mechanics and theoretical and applied fluid mechanics is a prerequisite.

Of the above publications reference (3) concerns itself most directly with submersibles, although other problems are addressed. In addition to these there are a variety of reports, both technical and non-technical, which are referenced throughout this text.

## PROPULSION AND MANEUVERING

Ideally there are six degrees of freedom (motion) desirable in the control of a submersible; these are shown in Figure 8.1 relative to an X, Y and Z axis and are classified as translational and rotational motions.

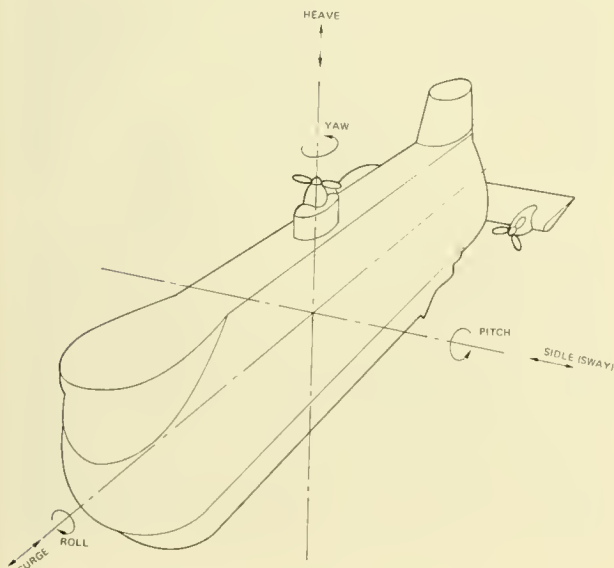

Fig 8.1 Translational and rotational motions

Translational motions occur when every point of the submersible has simultaneously the same speed and direction of motion. These are Heave (vertically up/down), Surge (forward/backward) and Sidle or Sway (laterally left/right).

Rotational motions occur around a center point or axis. These are Yaw (rotation around a vertical axis), Roll (rotation around the principal longitudinal axis) and Pitch (rotation around the principal transverse axis).

To varying degrees and through a variety of means, both translational and rotational motions, both singly and together, are obtained by most contemporary submersibles.

To acquire any or all of the six motions, a submersible requires a component to propel it and another to change its direction. In the most basic arrangement, a screw-type propeller provides forward/reverse translational movement (surge), a rudder provides left/right movement (yaw) and a movable plane or wings provide up/down (pitch) rotational movement. We treat first the devices that overcome the submersible's inertia, or make it move. These are: Free propellers, ducted propellers, Kort nozzle propellers, cycloidal propellers and water jets. Next we examine the devices that change its course or attitude. These are: Rudder and planes, thrusters and trim control.

## PROPULSION

### Free Propellers

The simplest means of submersible propulsion is the screw propeller (Fig. 8.2). In concept, the propeller can be thought of as screwing itself through the water—analagous to tapping a screw into a solid material where the rate of advance distance for each revolution is equal to the pitch of the thread. In practice, however, a screw propeller in water does not advance at a speed  $pn$  (pitch  $\times$  revolutions) per unit time. Instead, it travels at some lesser speed which is a function of the propeller slippage with each revolution. Thus, if a propeller having a pitch of 10 feet turns at 200 rpm, it would advance 2,000 feet in 1 minute in a solid; it does not do so in water because of slip, the difference between



Fig. 8.2 Free screw-type propeller.

the distance it would advance in a solid substance and the actual distance traveled, expressed as a percentage of the former. According to Taggart (6), the screw propeller is the most efficient means of obtaining propulsive force, and when used at its designed rpm and speed of advance its efficiency is exceeded by no other device. Miller (7) states the screw propeller's efficiency as 75 to 85 percent under ideal conditions and contrasts this with the 40 percent efficiency of a cycloidal propeller. Obviously, the submersible community is in agreement, for only the French vehicles *SP-350* and *SP-500*, and the U.S. Navy's *MAKAKAI* use other than screw propellers for propulsion. *NEKTON*'s propeller is of the open screw variety, in that the shroud around it is solely for protection, not to improve its efficiency.

### Kort Nozzle Propellers

By fitting a specially-designed shroud or nozzle around a screw propeller, its efficiency can be increased. The design shown in Figure 8.3 was invented and patented by Ludwig Kort in the U.S. in 1936. In cross section the nozzle resembles an aircraft wing with the outer side or face being practically straight and the inner side being cambered.

In practice the nozzle experiences a negative pressure forward of the propeller's plane of rotation and a positive pressure aft, which results in forward thrust. According to reference (2), in a well-designed propeller-nozzle combination the nozzle thrust is about half of the total thrust applied. A further advantage (8) is that the static shroud thrust is maximum at zero speed; in other words, it is most effective when the submersible begins moving from a stationary position. Reference is made by Taggart (3) to the Kort nozzle being particularly advantageous when operating under high slip conditions (during acceleration or when the vehicle is heavily loaded) and about equal in performance to the free propeller during low slip conditions. The advantage of obtaining greater thrust from a shrouded screw propeller at zero speed has not been ignored by the submersible builders—a large number of vehicles employ this feature. Equally attractive is the fact that a shrouded propeller can be considerably smaller than its "free" counterpart and still deliver maximum efficiency. This feature is desirable in that it decreases the overall vehicle size envelope.

### Ducted Propellers

Johnson and Barr (9) define a ducted propeller as any scheme which takes water

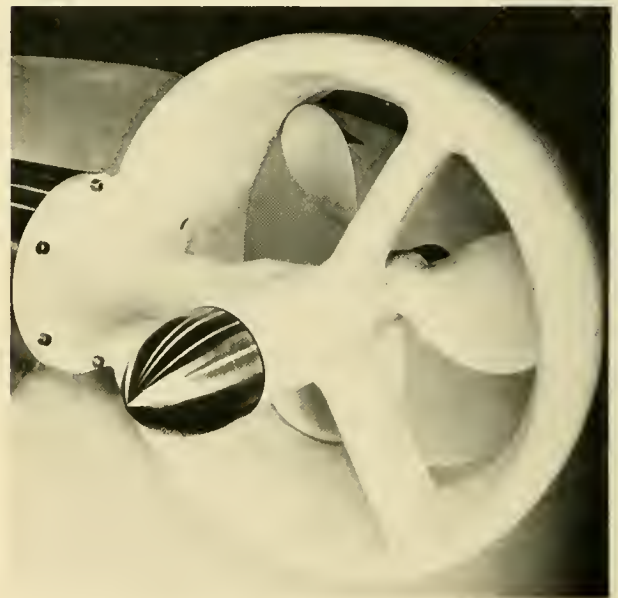

Fig. 8.3 A Kort nozzle surrounds the three-bladed thruster propeller of *ALVIN* (WHOI)

through an inlet flush with the hull, adds energy with a pump located within the hull and discharges it through a nozzle flush with the hull. Under this definition falls the ducted propellers of **DOWB** (Fig. 8.4). These ducts are located aft on **DOWB** and the propeller screw shafts are canted 15 degrees outboard. This arrangement provides the following advantages: The center of drag is moved aft for hydrodynamic stability and it reduces the beam while still maintaining a large twist moment aft. Analyzing the performance of ducted propellers, Johnson and Barr state that the inlet and outlet designs are extremely significant. Ideally, a well-designed duct would utilize a bell mouth inlet and a sharp exit extending a short distance beyond the hull. Where the duct exit is flush with the hull, jet entrainment effects cause low pressure in the exit side of the hull and reduce thrust where both ends of the duct are sharp and flush with the hull. In the case of **DOWB**, there could be a thrust reduction of unknown magnitude resulting from an eddy created near the hull by the exit jet. To prevent the propellers from foul-



Fig. 8.4 The Ducted Propellers on **DOWB** provide surge and yaw thrust. The two motors are in the deck plane of the vehicle and canted outboard at angles of 15 degrees. (NAVOCEANO)

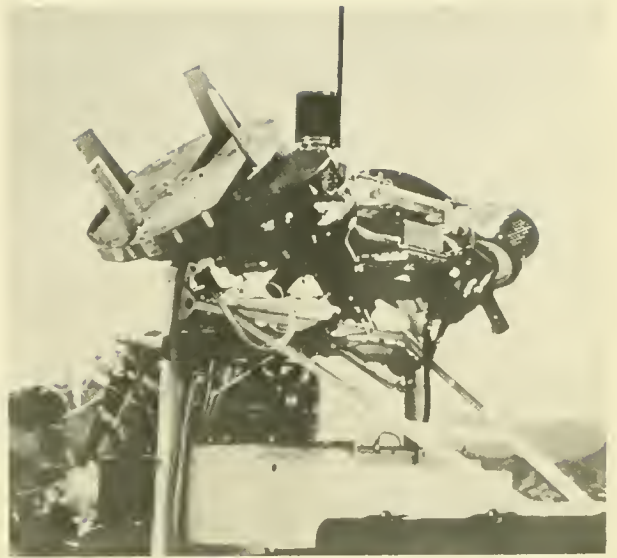

Fig. 8.5 Two pi-pitched cycloidal propellers attached to the exostructure of **MAKAKAI** provide its entire propulsion. (U.S.M.C. Air Station, Hawaii)

ing with ropes or cables while submerged, **DOWB**'s operators installed fine wire screens at both the inlet and exit ends. Such screens also reduce thrust by restricting the flow of water through the duct. This penalty, however, could be well worth the price in terms of safety. Ducted propellers, of varying designs, are found on quite a few vehicles—mainly because they reduce the vehicle's envelope and chance of entanglement and propeller damage.

### Cycloidal Propellers

The U.S. Navy's **MAKAKAI** is the only submersible known to use cycloidal propulsion (Fig. 8.5), although its predecessor **HIKINO** was the first. The two units on **MAKAKAI** are Kirsten Boeing, pi-pitch\*, cycloidal propellers mounted on the vehicle's exostructure which operate similar to a paddle wheel: The propeller disc rotates and moves the blades through the water. Talkington and Murphy (10) describe its operation as follows:

*“The cycloidal propeller is capable of directing its thrust in any direction in the propeller disc's plane of rotation. The pi-pitch propeller is used because of its mechanical simplicity and because of the four degrees of freedom propulsive control that can be obtained by using two thrusters. Thrust is*

generated by movement of the individual blades. Blade pitch is varied as the blade moves around its orbit so that the sum thrust of all blades is in the desired direction. This pitch is varied for the pi-pitch propeller by rotating the blade at one-half the disc rotational speed. Thrust direction is varied by changing the relative phasing of the blades with respect to the disc.

By placing the two thrusters at 45 degrees to the fore/aft vertical plane, 4 degrees of dynamic control (fore/aft, up/down, transverse, and yaw) are available (Fig. 8.6). This is arrived at by summing the thrust vectors. The coordination of the vectors is controlled by the pilot's hand controller

which directs the thrust in the direction his hand is moved. The farther the hand is moved in a particular direction, the greater the thrust magnitude and vehicle speed will be."

Cycloidal propellers offer several advantages: Superior steering and maneuverability, no need for rudders or external shafting and elimination of the resistance produced by such appendages. On the debit side, cycloidal propellers are far less efficient than screw-type propellers, they do not represent any size or weight savings and there are sealing problems (7). It would also seem that protection against damage to the propellers and underwater entanglement would be difficult to achieve without substantial loss of efficiency.

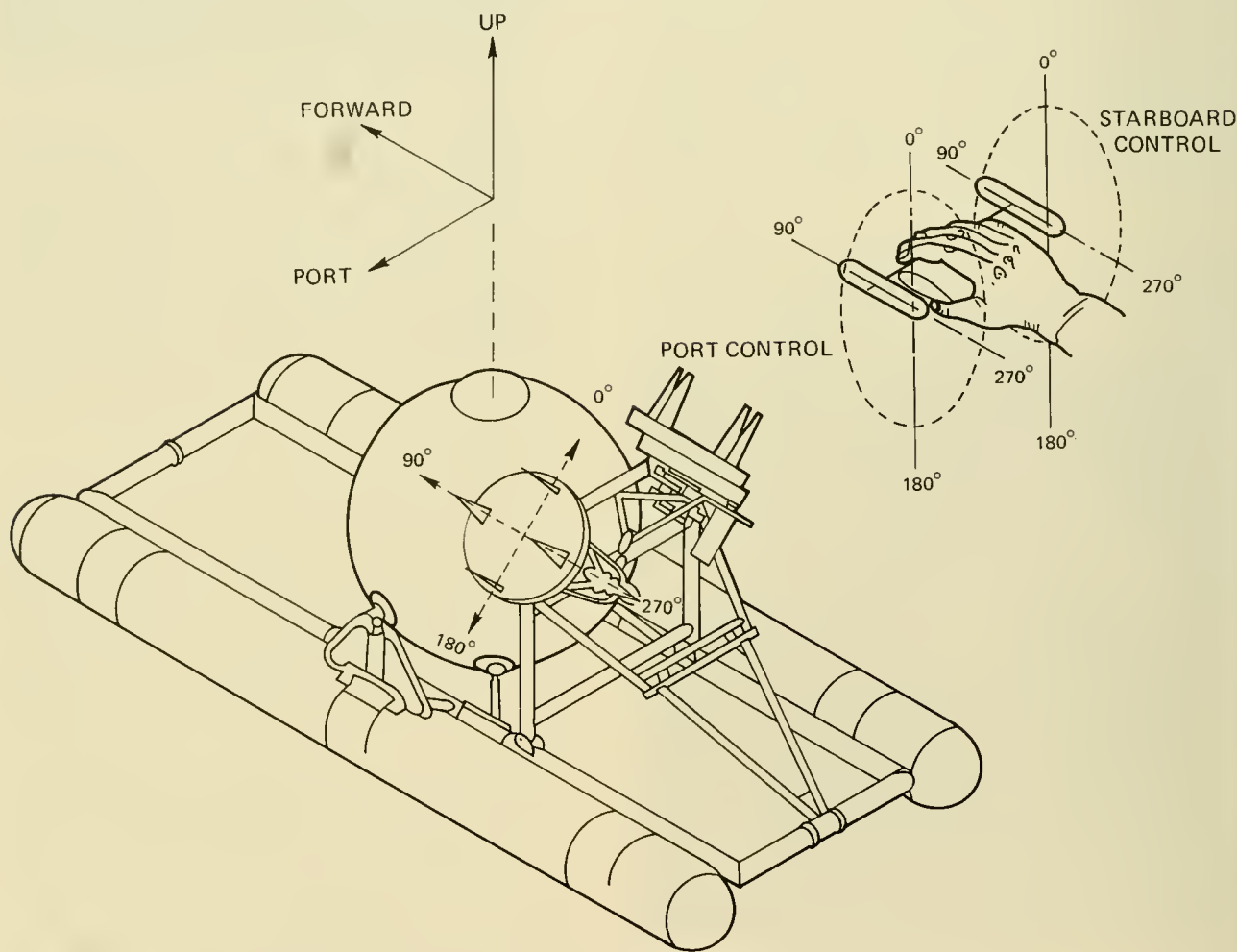

Fig. 8.6 MAKAKAI's thrusters' positions. [After Ref. (8)]

## Water Jets

The French *SP-350* (Fig. 8.7) and the two *SP-500*'s are the only submersibles known to use water jets as primary propulsion systems. Lockheed's *DEEP QUEST* employs this means also, but only for transverse augmentation of its primary screw propulsion. The heart of the *SP-350* system is a stern-mounted 2-hp electric motor-driven water pump which drives seawater forward through a "Y" shaped flexible tube to jets mounted port and starboard on the vehicle's brow. The jets are mounted so that a rack and pinion movement can rotate them in unison or individually from straight forward to straight down. The inefficiency and low speed of this system were known and understood by Cousteau, but for scientific research and underwater photography the advantages of high maneuverability overrode its disadvantages.

A comparison study between a number of the various propulsion devices described has been conducted and the results presented in a previously referenced report by V. E. Johnson and R. A. Barr (9). These authors summarized the results of experimental data to 1965, regarding free propellers, nozzles, ducts and tandem and cycloidal propellers, and related these data to the hydrodynamic performance of the propulsors. The report provides guidance in the selection of systems to satisfy propulsion and maneuvering requirements.

Two propulsion systems proposed, but reportedly never used on an operational submersible, are the tandem and varivec propeller systems.

## Tandem Propulsion System (TPS)

The TPS consists of two girdling bands of blades near the bow and stern of a submers-



Fig. 8.7 Propulsion for *SP-350* is provided by two water jets mounted port and starboard on the centerline forward. The port jet can be seen here pointing directly aft. (NAVOCEANO)

ible that can each provide controlled thrust in any direction (Fig. 8.8). For forward propulsion the pitch of the blades remains fixed; for translational thrust in any other direction the blade pitch can be cyclically varied with each revolution of the propeller. By thrust coupling the blades, rotation of the vehicle in any angular motion can be provided, thus six degrees of freedom are possible with the TPS. Model tests by the U.S.

Naval Ship R&D Center in the late 1960's showed the system to be capable of its proposed potential (up to 2.2 knots) beyond which the model became unstable. A stationary tail provided the model good stability at 3 to 5 knots, but beyond 6 knots the vehicle once again became inherently unstable. While 2.2 knots are more than satisfactory for submersible speed, other factors contributed to the demise of the TPS: The system is

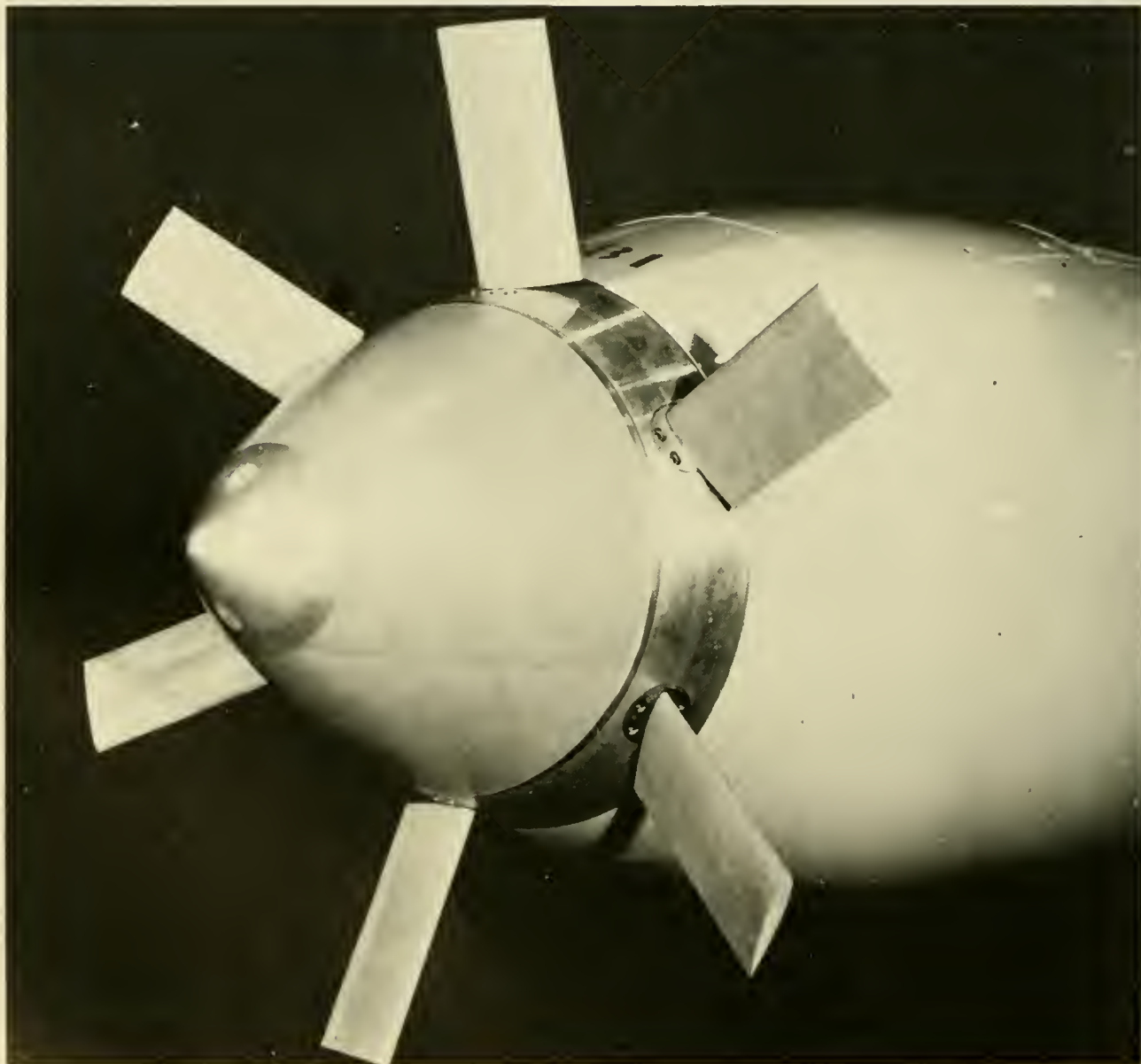

Fig. 8.8 One end of a cigar-shaped tandem propulsion system. (U.S. Navy)



very expensive, leaks around seals of the TPS were common and the complexity of the control system for six degrees of freedom was beyond human capability and required a computer (11).

### Varivec Propulsion System

The Varivec (variable vector) propulsion system was designed by Westinghouse for *DS-20000*, but never saw application since the vehicle was never built. A stern-mounted, variable pitch, three-bladed propeller (looking somewhat like a single TPS component, but with three blades instead of six) provides variable thrust from full ahead through zero to full astern by means of collective blade pitch control. Through cyclic pitch control a side thrust vector can be achieved to produce yaw directional control through 360 degrees (12).

Such are the actual and proposed devices that propel submersibles; in addition, the screw-type propeller is generally reversible, it can be varied in speed, and, as will be shown later, can also be oriented (trained) in different directions.

While submersible propulsion systems do not lend themselves to logical or systematic classification, they can be broken down between: Main Propulsion and Thruster.

**Main Propulsion** designates those propulsion devices on a submersible used *primarily* to provide forward thrust motion and for cruising. Main propulsion motors are usually more powerful than thruster motors. They may consist of the more classical arrangement—one or two stern-mounted propellers—or of paired port/starboard propellers mounted amidships on the vehicle. The majority of main propulsion motors are fixed; that is, unlike an outboard motor, they cannot be aimed left or right. Those that can be moved to vary their thrust angle are referred to as “trainable.”

**Thrusters** are those propulsion devices used *primarily* to move the vehicle left or right and up or down; they can provide this service while the vehicle is in motion or stationary. Thrusters are generally lower powered than main propulsion motors, and they are usually, but not always, mounted fore and aft. Thrusters may be so located and so oriented as to provide yaw or sidle motion,

heave and pitch motion or, by being rotatable through a full 360 degrees, any combination of motions. While these terms do not mean exactly the same thing to all submersible builders, they are generally accepted throughout the industry.

### Dive Planes, Rudders, Stabilizers

For maneuvering while underway, many submersibles are equipped with rudders (yaw control) and/or dive planes (pitch control), or both. A great number have neither dive planes nor rudders, but rely on propulsion motors to perform these maneuvers. To stabilize the moving vehicle a fixed fin or dive plane is sometimes attached or molded into the fairing.

Rudders produce force as follows: When the rudder is deflected to an angle of attack to the flow a force results. This resultant force may be broken into two components, one of which is parallel and the other normal to the direction of flow. Planes produce force in a similar manner. The parallel component is called the *drag* while the normal or effective steering component is called the *lift*. The lift of a rudder or plane is influenced by its area, area orientation and rudder angle; rudder configuration has less influence. Lift of rudders or planes varies considerably with, what is called, the *aspect ratio*. Aspect ratio is the ratio of the rudder's depth (span) to its width (chord), the latter being the dimension in the direction of water flow. For rudder or plane shapes other than rectangular the aspect ratio is the ratio of the square of the span to the lateral area. The turning effectiveness of rudders varies considerably with aspect ratio. The greater the aspect ratio, the higher the lift for a given rudder deflection. However, with a larger aspect ratio, the rudder will “stall” (lose lift) at a smaller angle.

The size and configuration of rudders and planes on submersibles is determined mainly by trial and error. Mr. Frank Cunningham, Design Engineer for Perry Submarine Builders, uses a rule-of-thumb that the rudder area should be at least as large as the area of the main propeller (about 2 ft<sup>2</sup>), with the dive planes equal to the rudder in size and shape (rectangular). Earlier Perry vehicles had the planes leading the bow, but because

of the flow of water around the bow they were not fully effective and subsequently were moved aft where they provided better control. While this trial-and-error approach may appear somewhat unsophisticated, there are no better guidelines available and Mr. Cunningham's concluding statement fairly well sums up the pragmatic approach private builders have taken in an area void of precedent: "It works!"

The shape and location of rudders and planes, and combinations thereof, vary from vehicle-to-vehicle, but a sampling of the different approaches can be obtained from the following examples:

**PC-3B** (Fig. 8.9) is equipped with a rectangular rudder which is manually turned left or right. Plexiglass bow planes, similar to those on **DEEP DIVER** (Fig. 8.10), control pitch.

Martine's **SUBMANAUT** (Fig. 8.11) combines both rudder and planes into a stern-mounted arrangement whereby yaw and pitch are obtained.

**SEA OTTER** (Fig. 8.12) had a rudder arrangement similar to Perry's **PC-3B**, but both rudder and propeller were shielded for

protection. This is now replaced by a Kort nozzle.

**DEEP QUEST** (Fig. 8.13) obtains yaw and pitch motion with hydraulically actuated rudder and stern planes. An automatic pilot system with integrated controls (discussed in Chap. 2) can "fly" the vehicle on a predetermined course, pitch angle and altitude.

The **DSRV** submersibles (Fig. 8.14) employ a unique pitch and yaw system. In this system a stern-mounted shroud encircles the main propeller which may be tilted fore and aft from the vertical and left and right, thus, combining a rudder/plane system in one unit. The shroud is not designed to redirect the propeller's thrust, but to orient lines to flow as does a rudder. Figure 8.15 shows the variation of shroud lift conditions with angle of attack for various aspect ratios as calculated by Lockheed during design of the **DSRV's**.

There is another system of pitch control which many vehicles with cylindrically-shaped hulls obtain by virtue of their small metacentric height. This consists merely of the occupants leaning or moving fore or aft within the vehicle. While such tenderness



Fig. 8.9 The PC-3B is provided yaw motion by its stern rudder and pitch by plexiglass bow planes not visible here. (NAVOCEANO)

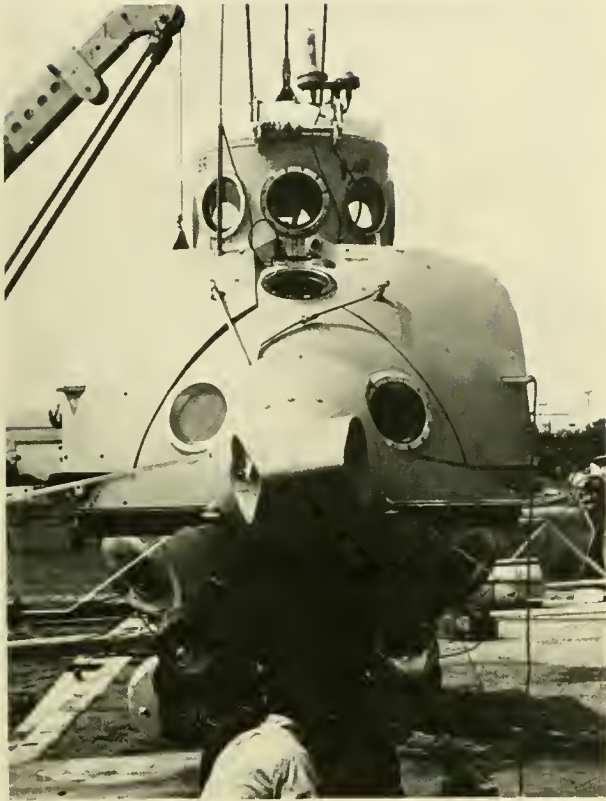

Fig 8 10 Plexiglass bow planes on *DEEP RIVER* provide pitch motion. The central duct encloses a reversible screw propeller which can be rotated 360 degrees to obtain propulsion in any vertical plane. (NAVOCEANO)

can make piloting difficult, it can be used to advantage in surmounting sudden, vertical obstacles in the vehicle's path. A number of vehicles have fixed (non-moving) fins or sails for stabilization at higher speeds. At the very low speeds at which submersibles work and transit, the need for such stabilizing surfaces is sometimes debatable. Indeed, as related in Chapter 5, Mr. Edwin Link and others go to the other extreme—decrying even the need for fairings to streamline the vehicle. Whether they are necessary or not, they are still on the vehicle where they assume a variety of shapes and sizes. Two arrangements of stern-mounted stabilizers are shown in Figures 8.16 a & b on *STAR III* and *BEAVER*, respectively. Supporting the non-stabilizer faction, *PISCES II* and *III* originally had tail fins; experience showed that these were more a hindrance than a

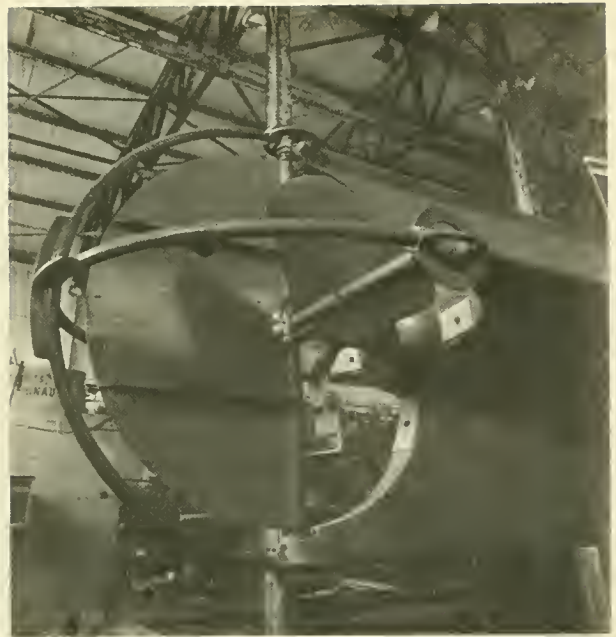

Fig 8.11 Martine's *SUBMANAUT* obtains yaw and pitch motion from stern-mounted rudder and planes

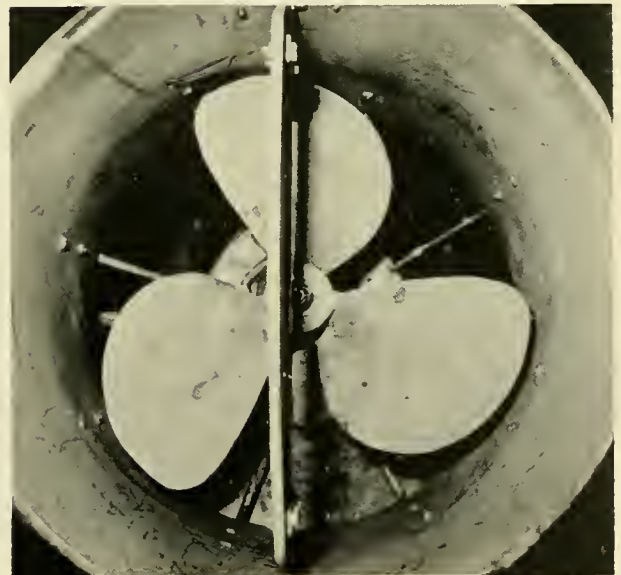

Fig 8.12 Both propeller and rudder are ducted in *SEA OTTER* for protection and greater efficiency.

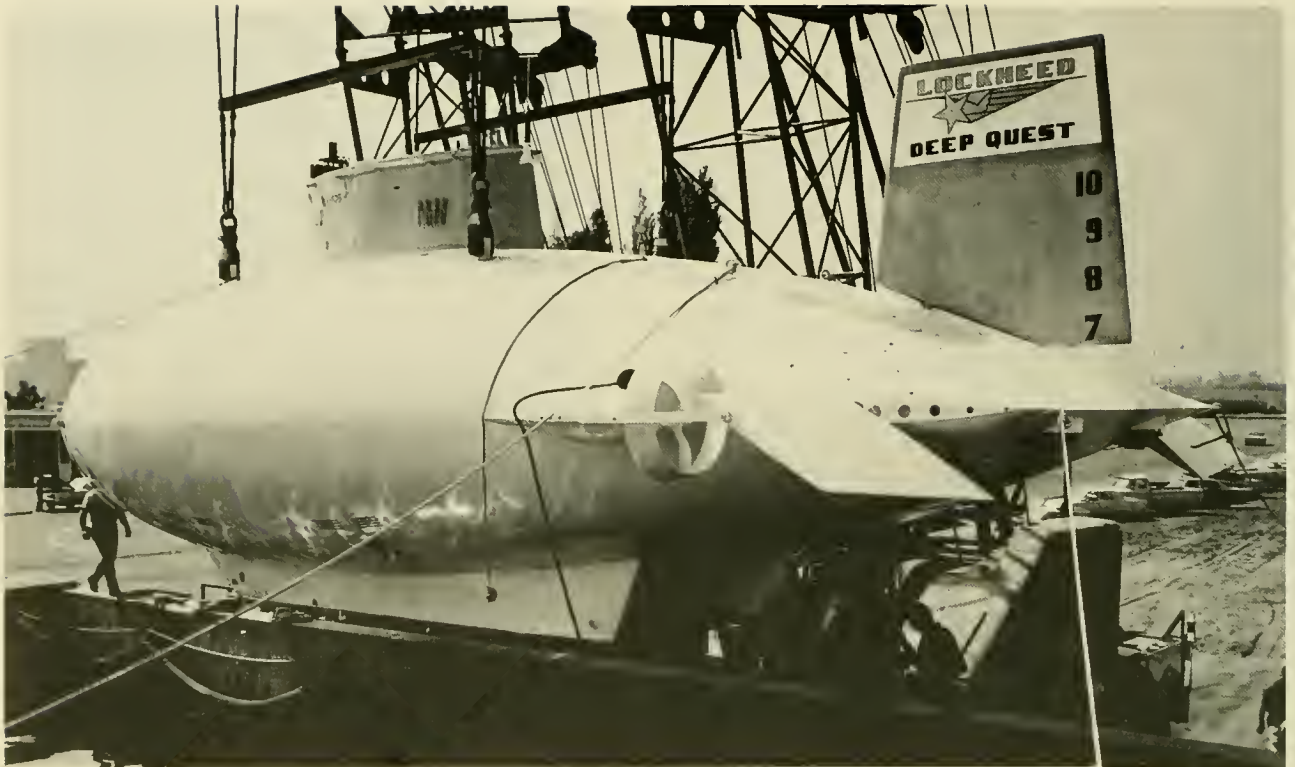

Fig 8.13 The sophisticated *DEEP QUEST* uses hydraulic actuators to orient its rudder and dive planes. (LMSC)

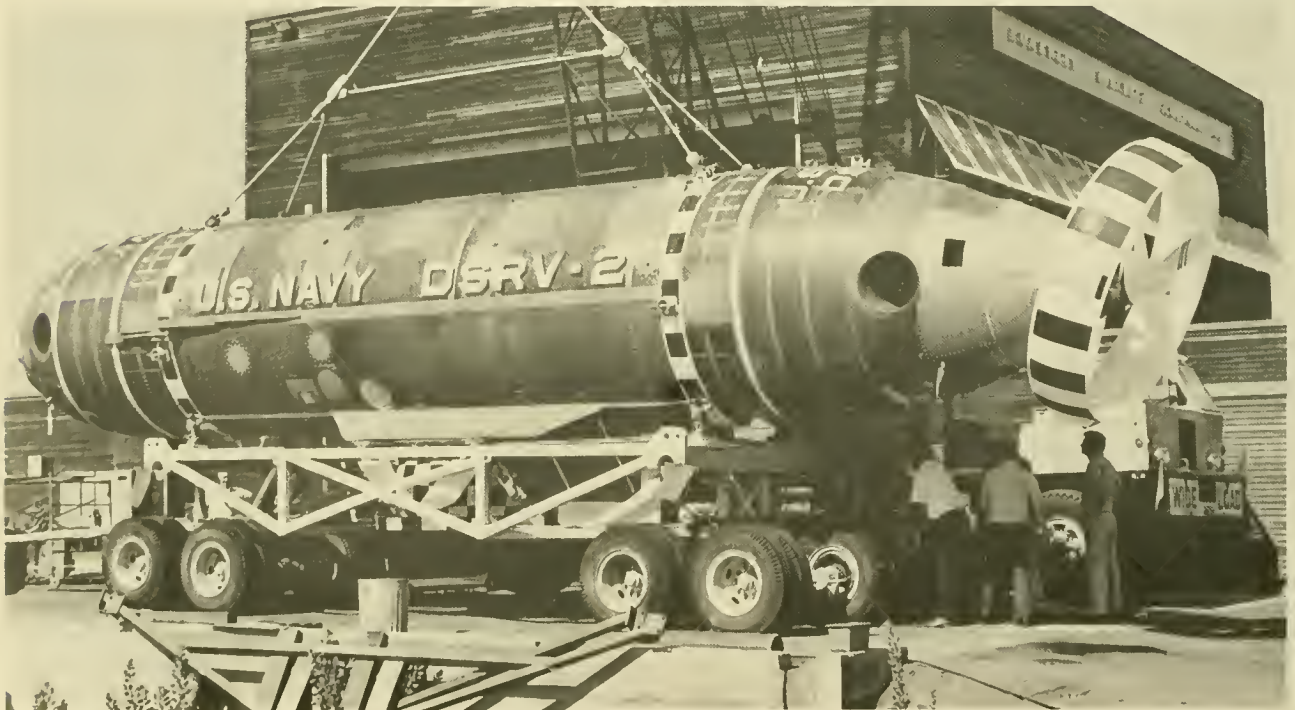

Fig. 8.14 *DSRV-2*'s stern shroud tilts fore and aft, and left and right, to provide yaw and pitch motion. The fore and aft circular ducts house lateral (yaw and side) thrusters. (U.S. Navy)

help and the later *PISCES* vehicles (*IV* & *V*) abandoned the fins (Fig. 8.17) for easier access to the aft machinery sphere, improved handling and because they were of little control value anyway. The fins were taken off *PISCES II* and *III* when purchased by Vickers. Ironically, had the fins been left on the *III* vehicle, the entanglement and subsequent flooding of the machinery sphere which led to its sinking could not have occurred (see Chap. 15).

## MANEUVERING

The widest divergence of design philosophy in manned submersibles is found in the approaches taken to maneuvering and, based on current submersibles employment records, there seems to be no best and no worst approach. About the only way to categorize

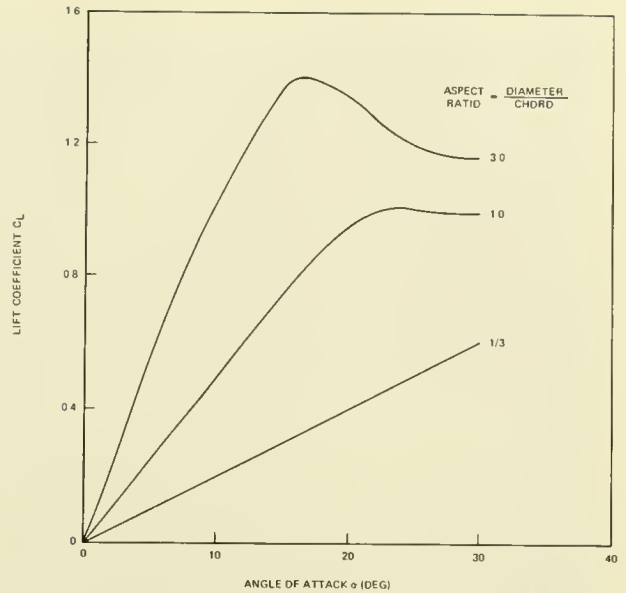

Fig. 8.15 Variation of shroud lift coefficient with angle of attack for various aspect ratios.



Fig. 8.16 *STAR III* and *BEAVER*. Showing two different configurations of fixed stem stabilizers. (Gen. Dyn. and North American Rockwell)

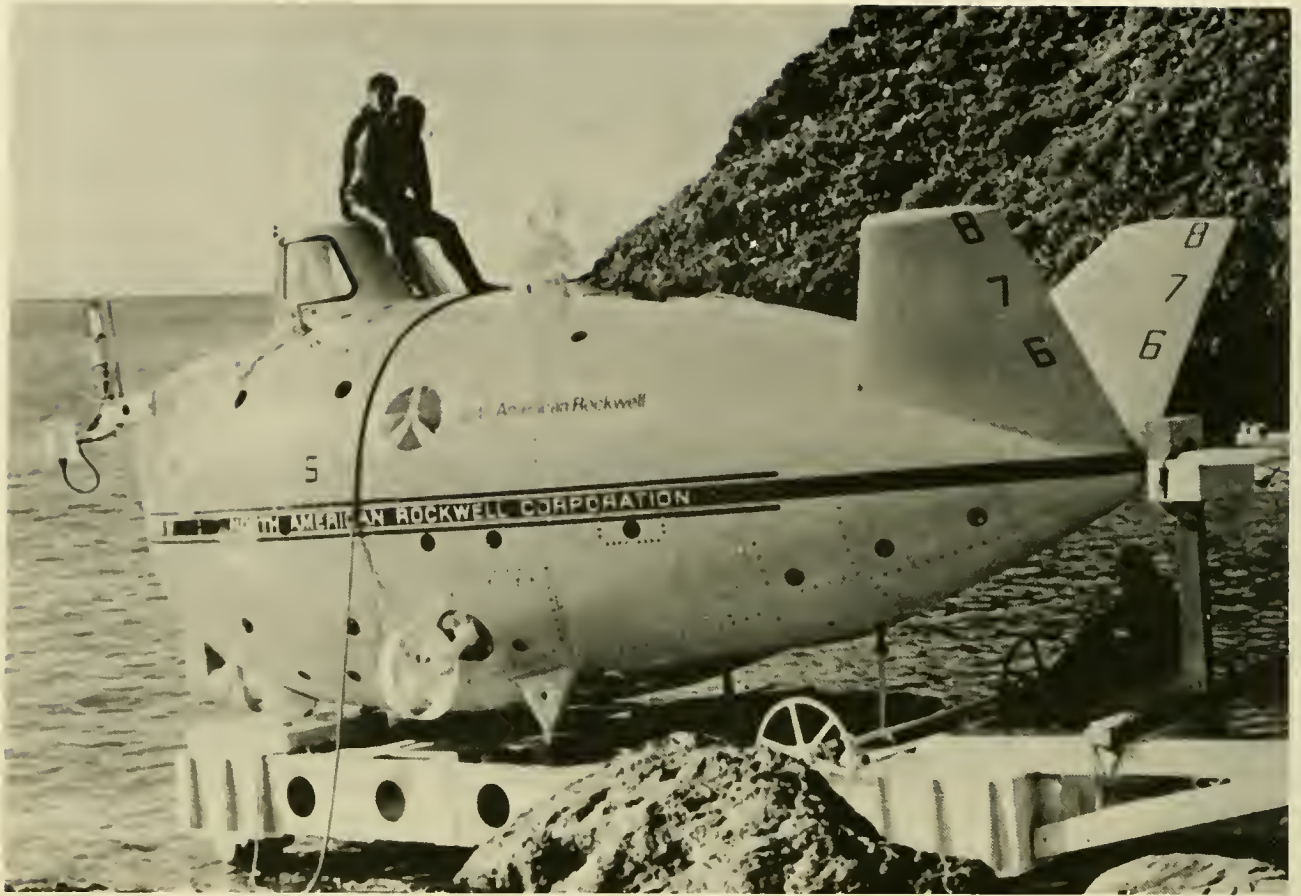

Fig. 8.16 BEAVER.

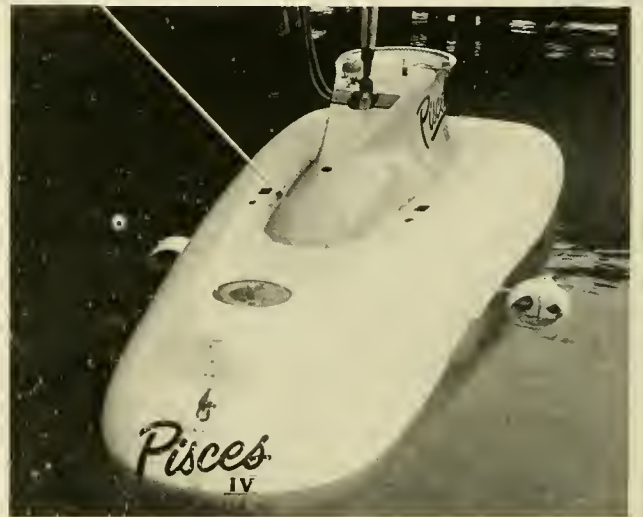
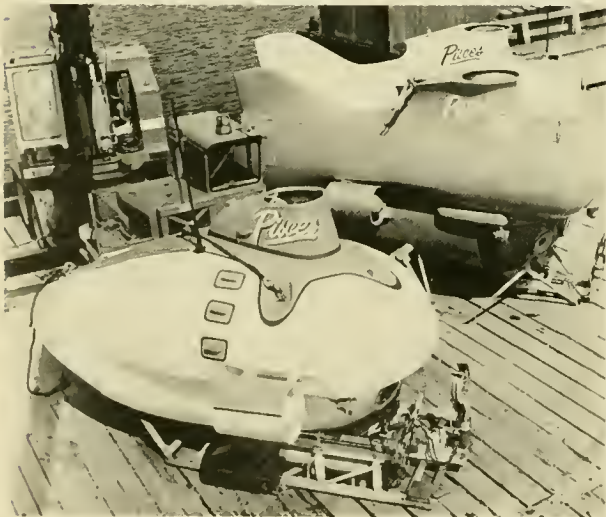

Fig. 8.17 Tail fin stabilizers on PISCES II & III (left background) were discontinued on later vehicles of the PISCES IV variety (right). (International Hydrodynamics)

the means of maneuvering is between vehicles that rely solely on motors and those that use motors in combination with planes and a rudder. In each case the location and versatility of motors and the shape and location of the planes and rudders all vary widely and defy categorization. In an attempt to impose some order into an area dominated by the "free spirit," the following discussion proceeds along the lines of degrees of freedom obtained by the "motors only group" versus the "motor and rudder/planes group."

To hold this narrative to manageable proportions, only the motions obtained by motors, planes and rudder are discussed. As was shown in Chapter 6, submersibles have the ability to gain pitch and roll by virtue of variable ballast tanks, battery shifts, mercury transfer and what-not. A discussion of these is not repeated here. Similarly, most submersibles can obtain heave motion by virtue of ballasting or deballasting. Previously mentioned is the control the operator has on motion by merely shifting his weight. Discussed later in this chapter, but directly related to maneuvering capability, is the ability of most vehicles to run their motors at variable speeds independently of each other and in opposing directions. This feature provides a great deal of the yawing capability on vehicles where two motors are used for main propulsion.

A variety of other maneuvering options are available. For example, *DEEP QUEST* can attain a high upward pitch angle while stationary on the bottom by transferring mercury from forward to aft, *ALUMINAUT* used its manipulators to climb hand-over-hand up the side of *ALVIN* in 1969 to insert a toggle in *ALVIN*'s hull, and *NEMO* can attain heave by reeling its anchor in or out in a yo-yo-like fashion. In actual operations, these and other options are brought into play to provide virtually any motion or maneuver desired. These options must be added to the basic degrees of freedom motions discussed below.

## Propulsive Control

### Thrust and Yaw:

The most basic of motions, to move forward (or backward) and change heading (underway or bottomed), are obtained by:

- a) Two port/starboard reversible propellers fixed in a horizontal position and mounted either amidships or on the stern. By slowing down or reversing one propeller the vehicle can be made to yaw. Submersibles in this category are *DS-4000* (Fig. 8.18a), *PISCES I, II, III, IV* and *V*, *SP-3000*, *SDL-1*, *FNRS-2 & 3* and *SNOOPER*.
- b) Two reversible stern propellers with a lateral bow thruster for additional help in changing heading. *TRIESTE II* (Fig. 8.18b) uses this method.

### Thrust, Yaw, Heave:

Adding the ability to maneuver vertically up or down to that of traversing and changing course, the following procedures are followed:

- a) Two port/starboard fixed, reversible propellers capable of being rotated 360 degrees in the vertical plane. *NEMO* (Fig. 8.18c) used this arrangement (its shape and low center of gravity held it in a vertical position) in addition to an anchor and winch for heave motions.
- b) One (*ARCHIMEDE*) or two (*DEEP VIEW*) stern-mounted, reversible propellers, one lateral thruster and one vertical thruster (Fig. 8.18d).

### Thrust, Yaw and Sidle:

Two vehicles can be found with this capability, *MERMAID* (Fig. 8.18e), which uses a reversible stern propeller and two lateral thrusters (one fore, one aft), and *NEREID* which uses a trainable, reversible, stern propeller in conjunction with a fixed, reversible lateral thruster mounted forward.

### Thrust, Yaw, Heave, Pitch:

The greatest number of submersibles using only motors for maneuvering fall into this group, and the ways to achieve these motions are quite varied:

- a) Two reversible propellers mounted port and starboard amidships and capable of rotating 360 degrees in the vertical plane. Vehicles using this system are all small and consist of the *All Ocean Industries'* vehicle, *GUPPY, K-250* (Fig. 8.18f), *STAR I*, *ASHERAH*, *BENTHOS V*, *SURV* and *TOURS 64 & 66*. A roll motion can be placed on these vehicles by directing one propeller's thrust up-

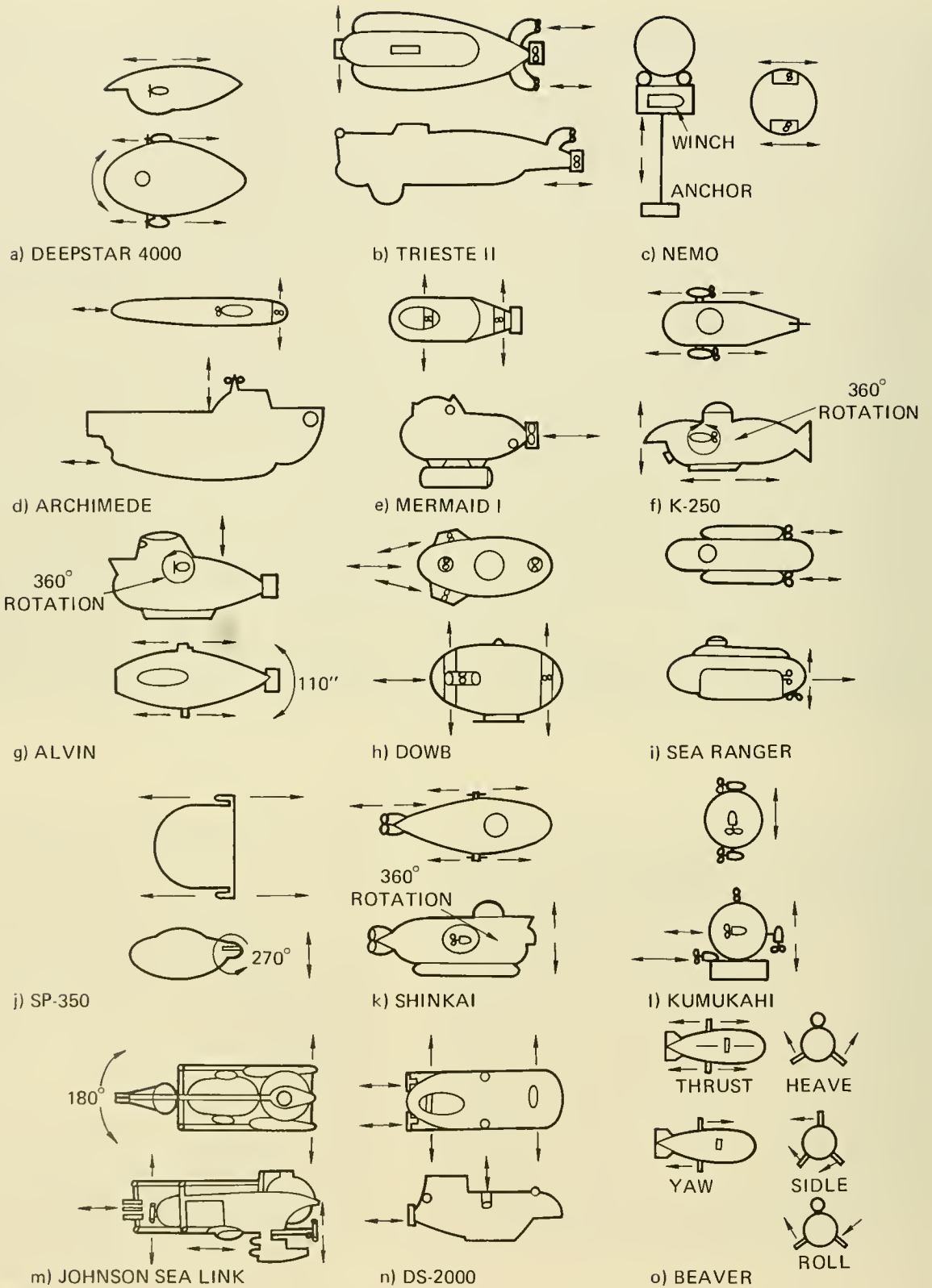

Fig. 8.18 Maneuvering by propulsion.



ward and the opposing one downward.

- b) Laterally trainable, stern-mounted propeller with port/starboard, 360-degree rotating thrusters amidships. *ALVIN* (Fig. 8.18g), *SEA CLIFF* and *TURTLE* fall into this group.
- c) Two reversible, fixed and ducted stern propellers (pointing 15° outboard) and two fixed, reversible, vertical thrusters fore and aft. *DOWB* (Fig. 8.18h) can obtain pitch by operating the thrusters in opposition.
- d) Two fixed, reversible stern propellers and one fixed reversible, vertical stern thruster. *SEA RANGER* (Fig. 8.18i) employs this system. The vertical thruster provides pitch and, it is believed, with proper vehicle trim can also provide heave.
- e) Two variable-speed, port/starboard water jets mounted on the bow and capable of rotating 270 degrees in the vertical plane. *SP-350* (Fig. 8.18j) and *SP-500* use this system.
- f) One fixed, reversible stern propeller and two port/starboard, reversible thrusters capable of 360 degrees of rotation in the vertical plane. *SHINKAI* (Fig. 8.18k) uses this approach.

#### **Thrust, Yaw, Heave, Sidle:**

In this group are two submersibles, each with a different means to the same end.

- a) The Navy's *MAKAKAI* uses two pitch-cycloidal propellers, which were described earlier.
- b) *KUMUKAHI* employs four reversible, fixed, port/starboard thrusters, and one vertical and one lateral thruster, both of which are fixed and reversible (Fig. 8.18l).

#### **Thrust, Yaw, Heave, Pitch, Sidle:**

Two submersibles obtain these motions exclusively through propulsion alone: The *JOHNSON SEA LINK* and *DS-2000*.

- a) The *JOHNSON SEA LINK* (Fig. 8.18m) carries eight reversible propellers which are arranged to provide the following:  
Three trainable (90° port/starboard) stern-mounted propellers provide thrust and yaw. One bow-mounted and laterally oriented thruster also provides yaw and, in combination

with stern propellers in proper orientation, sidle. Two vertical fore and aft thrusters provide heave and pitch. Two port- and starboard-mounted, fore-and-aft thrusters are situated amidships to assist in thrust.

- b) *DS-2000* employs two fixed, reversible, stern propellers, two fixed, reversible fore- and aft-mounted vertical and fore- and aft-mounted lateral propellers (Fig. 8.18n).

#### **Thrust, Yaw, Heave, Sidle, Roll:**

*BEAVER* has three reversible, 360-degree rotatable propellers mounted in an inverted "Y" configuration amidships around its hull; through a variety of orientations and thrust combinations five degrees of freedom are obtained as demonstrated in Figure 8.18o. Similar to *NEMO*, *BEAVER* also carries an anchor and winch which can be used to obtain a yo-yo-like heave motion and fore and aft transfer of mercury provides pitch.

#### **Control by Motors, Rudders and Planes**

The greatest number of shallow diving submersibles is found in the group relying on rudders and planes, in addition to propellers, to maneuver. The use of planes and rudders has one obvious disadvantage: They are only effective when the vehicle is underway; thrusters are effective when the vehicle is at zero speed.

#### **Thrust, Yaw, Heave:**

The two General Dynamics' submersibles *STAR II* and *STAR III* fall into this category and both vehicles' rudders are hydraulically powered.

- a) *STAR II* (Fig. 8.19a) is equipped with two fixed, reversible, stern propellers, one fixed, reversible, vertical thruster atop the vehicle just aft of the hatch and enclosed within the fairing. A rudder is formed from the lower trailing edge of a cruciform tail section.
- b) *STAR III* (Fig. 8.19b) utilizes one fixed, reversible stern propeller, a vertical thruster mounted similar to *STAR II*'s, a fixed, reversible lateral bow thruster ducted within the exostructure and a rudder formed from the trailing edge of its inverted Y-shaped tail section.

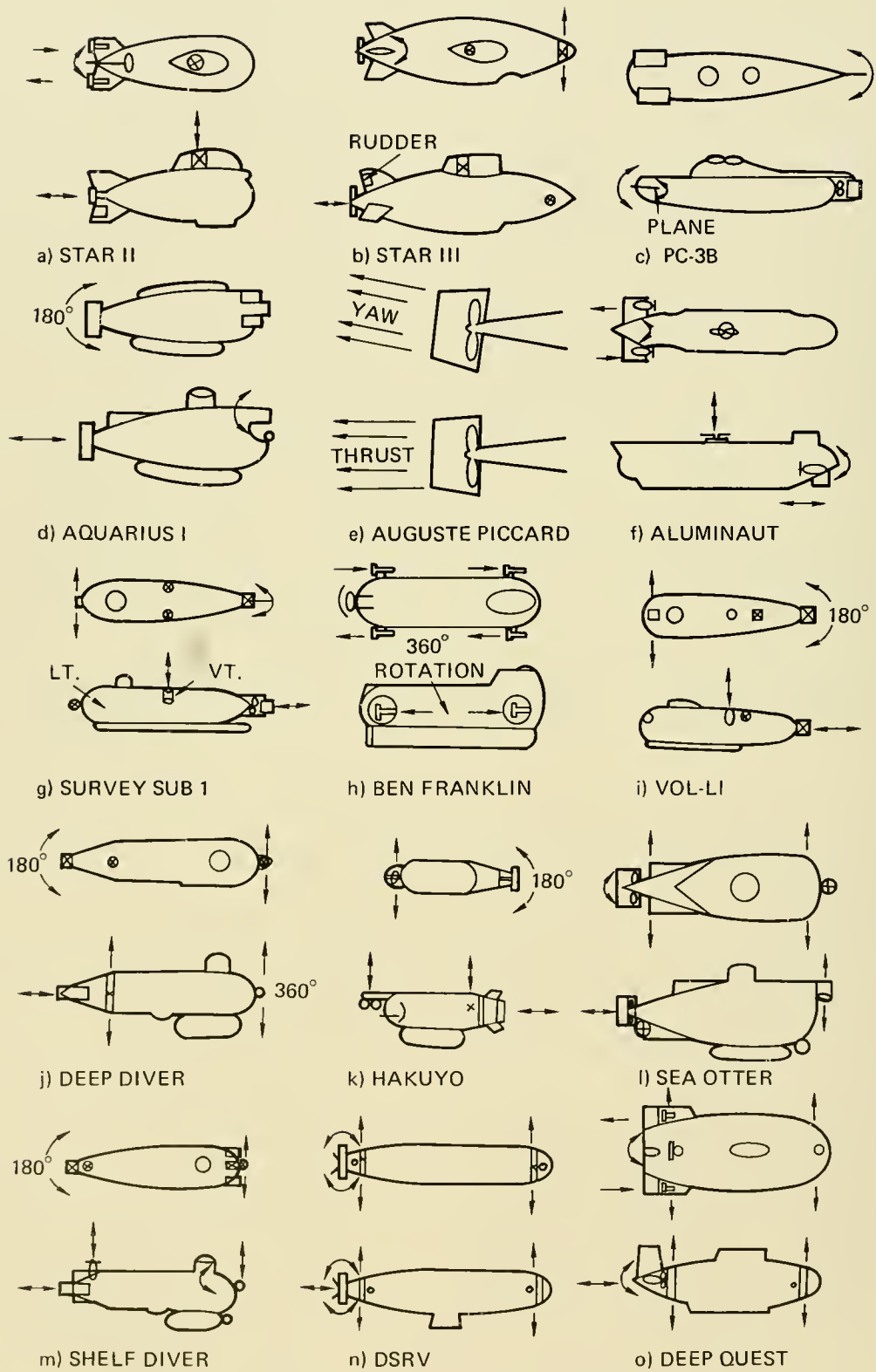

Fig. 8.19 Maneuvering by propulsive and non-propulsive devices.

### Thrust, Yaw, Pitch:

A total of 18 vehicles obtains these three degrees of freedom utilizing three different approaches. Pitch in all cases is provided by dive planes; yaw is obtained in two instances with other than rudders.

rudders.

- a) In the most general situation, maneuvering consists of a fixed, reversible stern propeller, a rudder and dive planes; the only variation is in the location (and shape) of the dive planes. The following vehicles have bow planes: *NAUILETTE*, *NEKTON A, B, and C*, *PC-3A1 and 2*, *PC-3B*, *PC3-X* and *SPORTSMAN 300 and 600*. Aft dive planes are found on the *MINI DIVER* and Martine's *SUBMANAUT* (Fig. 8.11) while the dive planes are mounted amidships on *SEA-RAY*. *KUROSHIO II* combines both fore and aft planes with a rudder. While the location of planes varies, the motions obtainable are equivalent and *PC-3B* (Fig. 8.19c) is used to demonstrate this arrangement.
- b) In place of a rudder, *AQUARIUS I* has a trainable stern propeller (90° port/starboard) to provide yawing motion. This propeller is also reversible and a bow plane provides pitch motion (Fig. 8.19d). *PAULO I* had a similar system, but its dive planes were mounted aft in a fashion similar to Martine's *SUBMANAUT*.
- c) *AUGUSTE PICCARD* has both fore and aft hydraulically controlled dive planes (called hydroplanes) to provide pitch. To obtain yaw, its Kort nozzle can be directed 25 degrees to port or starboard while its fixed, reversible stern propeller remains in one position. While the approach to yaw is different from those of *PC-8* and its associates, the result is the same. Figure 8.19e shows only the motion of the Kort nozzle on *AUGUSTE PICCARD*.
- d) *TOURS 64 and 66* employ a rudder and port and starboard mounted propellers amidships. Both propellers are reversible and capable of 210 degrees of rotation in the vertical plane.

### Thrust, Yaw, Heave, Pitch:

By including vertical thrusters in a propel-

ler/rudder/planes arrangement, the motion of heave is included in two vehicles.

- a) *ALUMINAUT* (Fig. 8.19f) employs two fixed, reversible stern propellers, a fixed, reversible vertical thruster top-side amidships, a hydraulically-powered rudder and aft dive planes.
- b) *SURVEY SUB I or TS-1* (Fig. 8.19g) obtains similar maneuverability using one fixed, reversible stern propeller, one fixed, reversible, lateral bow thruster, one fixed, reversible, vertical bow thruster, bow planes and a rudder.

### Thrust, Yaw, Heave, Pitch, Roll:

*BEN FRANKLIN* (Fig. 8.19h) is equipped with four 360-degree, rotatable, reversible thrusters mounted port and starboard, fore and aft. Hydraulically-powered rudders assist in yaw motion. The roll motion is assumed to be obtainable by orienting the port and starboard pairs in vertical opposition to each other, though this effect is not stated by the manufacturers.

### Trust, Yaw, Heave, Pitch, Sidle:

By various arrangements of thrusters, rudders and planes, seven vehicles obtain these motions, each with a system different from the others.

- a) *VOL-LI* (Fig. 8.19i) has one 180-degree laterally trainable, reversible, stern propeller, one fixed, reversible, lateral bow thruster and one vertical thruster aft and dive planes port and starboard amidships.
- b) *DEEP DIVER* (Fig. 8.19j) has one 180-degree laterally trainable, reversible, stern propeller, one bow thruster capable of rotating 360 degrees in the vertical plane, one fixed, reversible, aft lateral thruster and bow dive planes.
- c) *HAKUYO* (Fig. 8.19k) has one 180-degree laterally trainable, reversible, stern propeller, two fixed, reversible, vertical thrusters fore and aft, one lateral thruster forward and bow planes.
- d) *SEA OTTER* (Fig. 8.19l) has one fixed, reversible, stern propeller, two fixed, reversible, lateral thrusters fore and aft, one fixed, reversible, bow thruster and a rudder.
- e) *SHELF DIVER* (Fig. 8.19m) has one 180-degree laterally trainable, reversible, stern propeller, two fixed, reversible,

vertical stern and bow thrusters, one fixed, reversible, lateral thruster fore and aft and bow planes.

f) **DSRV-1 & 2** (Fig. 8.19n) has one fixed, reversible, stern propeller, one each (four altogether) fixed, reversible and ducted, lateral and vertical thruster fore and aft, port and starboard trainable stern shroud. Roll is obtained by transfer of mercury from one side to the other.

g) **DEEP QUEST** (Fig. 8.19o) has two fixed, reversible, stern thrusters, two fixed, reversible, ducted vertical thrusters fore and aft, two fixed, lateral water jets fore and aft (to provide sidle), hydraulically-operated stern dive planes and a rudder.

The degrees of freedom described for each of the above vehicles were present at one time and may still remain. It is obvious that merely adding a thruster or re-orienting an existing unit can change these motions. Such changes have occurred in the past and there is no reason to suspect that varying missions might not prompt such changes again.

While the approaches to maneuverability have varied, there is a growing practice among current builders toward laterally-trainable stern propulsion units. This feature provides more responsive and controllable yaw motion without the aid of a rudder and provides it at zero speed of advance. In combination with a lateral bow thruster, the 180-degree trainable, stern propeller also provides sidle motion.

An interesting approach to steering and propulsion was presented by Wozniak *et al.* (13) and termed "Wake Steering." Wake steering employs a propeller in a converging-diverging nozzle with four slots through the surface which may be selectively opened to provide radial thrust (Fig. 8.20). Wozniak and his associates offer the following explanation behind the radial thrust producing forces.

***"The combined action of the vehicle forward motion and propeller induced flow results in a low ambient static pressure on the inside surface of the nozzle, in fact, the propeller wake attaches to the nozzle. By opening a small port in the wall of the nozzle,***

***exterior fluid is induced into the main flow. This action results in a circumferential variation of the interior pressure and local separation of the wake which in turn causes a net radial thrust. Turning forces for various maneuvers are thus developed by opening one or a combination of ports. Pure axial thrust is obtained when all ports are closed."***

The wake steering concept had only undergone experimental and theoretical analysis at the time of their report (1972) and, as the authors concluded, produced more questions than answers. It is described herein because it is a fixed system which, theoretically, can produce thrust, yaw and pitch motions with only one propeller and a fixed, instead of trainable, nozzle.

## MOTORS

Regardless of the propulsor type or the

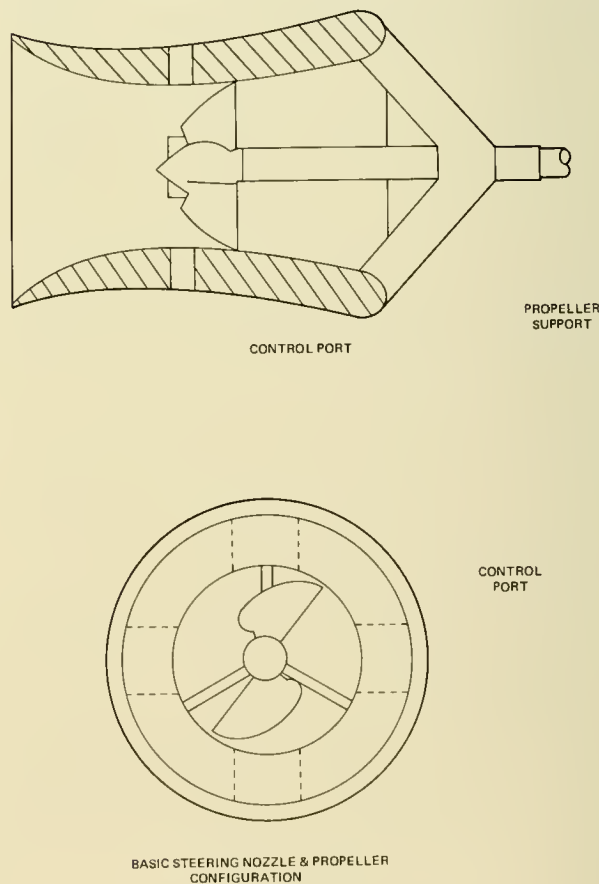

Fig. 8.20 Wake steering nozzle and propeller. [From Ref. (13)]

nature of its containment, all submersibles use electric motors to initiate and maintain motion. The motor may be directly coupled to a rotating shaft, or it may move the shaft indirectly through an intermediary hydraulic pump. The nature of such motors (or propulsive power) depends, in part, upon the vehicle's size and configuration and the desired speed. Neglecting motor horsepower requirements for the moment (dealt with in the following section), let's turn to an examination of the design and electrical current options available to the submersible designer.

### Alternating Versus Direct Current Motors

The choice between a propulsion motor operating on alternating or direct current has been almost unanimously in favor of DC. Only 9 of the 100+ submersibles use AC propulsion motors; the reason is one of economics. While AC motors are simpler in design and construction, and require less maintenance, an inverter must be supplied to change DC to AC. This adds weight and will take away from pressure hull space if mounted therein. More importantly, the inverter adds to both the vehicle's cost and complexity.

DC motors, on the other hand, can be operated directly from the battery, they have better speed control than AC, and produce higher torque. Because DC motors use commutator bars and brushes they must be protected from seawater; additionally, they require more frequent maintenance, which may be every 40 to 50 hours of service. This latter feature has not been a great disadvantage because most vehicles are taken out of the water after each dive when such maintenance may be performed.

Before examining the design of present electric motors, a basic problem should be identified. A screw-type propeller turns on a shaft which in turn is rotated by an electric motor. Somewhere in this scheme the components of the motor must be protected from seawater. The most obvious solution is to place the motor inside the pressure hull or inside a pressure-resistant case, but the fact that the shaft must both penetrate the case

and rotate within this penetration presents severe problems. From earlier chapters it was seen that thru-hull shaft penetrations which are watertight and pressure resistant are common, but when the shaft must maintain these two features and rotate at the same time a new set of problems is confronted. In essence, a dynamic seal capable of limiting the leakage of seawater into a 1-atmosphere motor container is not available for great depths. In some shallow vehicles, *e.g.*, the **NEKTON** series and the Perry vehicles, the pressure at their operating depth can be overcome by a pseudo-packing gland. In these vehicles the motor is contained in a separate, pressure-resistant compartment either outside or inside the hull. The only relatively deep submersible in which the drive shaft penetrates the pressure hull and the motor is not sealed off from the hull in a separate compartment is the 2,500-foot **AUGUSTE PICCARD**. The water-tightness of **AUGUSTE PICCARD**'s propeller shaft is obtained by a graphite joint inside of which is a packing gland. An inflatable rubber ring serves as a security fitting between shaft bearing and the hull. A variety of contact seals of this nature is presented in reference (14), and this report concludes that all contact-type seal configurations are, in effect, bearings whose generated pressure and clearance are utilized to restrict leakage. Design of such seals is, according to Sasdelli and Spargo (*ibid*), a trade-off between wear and leakage, and in the military submarine where large, powerful propulsion plants are required and must be protected from both nature and man, the problem is severely complicated. In manned submersibles, propulsion power requirements are minute in comparison and nature, through formidable is the only adversary.

A state-of-the-art summary of propulsion motors for submersibles was presented by Mr. L. A. Thomas of Franklin Electric Company in 1968 (15). Though modifications have taken place since this summary, the motor categorizations and the design principles Thomas outlined are still applicable.

Thomas presented three different design concepts in electric motors for outboard (vs. in-hull) propulsion in seawater: Open-

winding, Water-filled; Open-winding, Oil-filled; and Hermetically sealed motors.

#### Open-Winding, Water-Filled Motors:

In this design the machinery is open to the sea and operates within the ambient seawater environment where circulating seawater both cools and lubricates the motor. The stator coils are magnet wire insulated with a heavy-duty waterproof coating, such as polyvinyl chloride (PVC). The advantages to this system are that no dynamic seals are required and a supply of machinery fluid is always available. On the debit side, the poor lubricating, electrical and corrosive properties of seawater call for a very high degree of reliability in components (standard ball or roller bearings would have a limited life-span). To restrict the introduction of large particles and organic materials, a shaft seal can be installed and internal water compensated to ambient pressure, but, as Thomas points out, some biological growth and corrosion is still likely.

#### Open-Winding, Oil-Filled Motors:

The stator coils of this motor are wound of

standard varnish insulated magnet wire. The machinery system may be filled with a dielectric fluid which provides protection against corrosion, and also cools and lubricates. Also, the entrained fluid acts as a pressure-compensation system where a shaft seal keeps water out and the pressure differential across the seal can be minimal. This system is one of the more popular types used in submersibles with DC motors. Its reliability is strongly influenced by the effectiveness of the seal. The simplest system uses one seal and one pressure compensator to maintain the machinery compartment at ambient pressure or slightly higher. The majority of seal systems on electric drives uses two axial face seals at the machinery-shaft-sea interface and two pressure compensators. An example of this type of seal design in a system is shown in Figure 8.21. If seawater leaks into the system the motor may fail quickly by short circuiting. However, DOT studies of such seals concluded (6 Feb. 1973) that no serious problems with these seals have been reported to date, and tests they performed substantiated this observation. Static leakage immediately after assembly has been re-

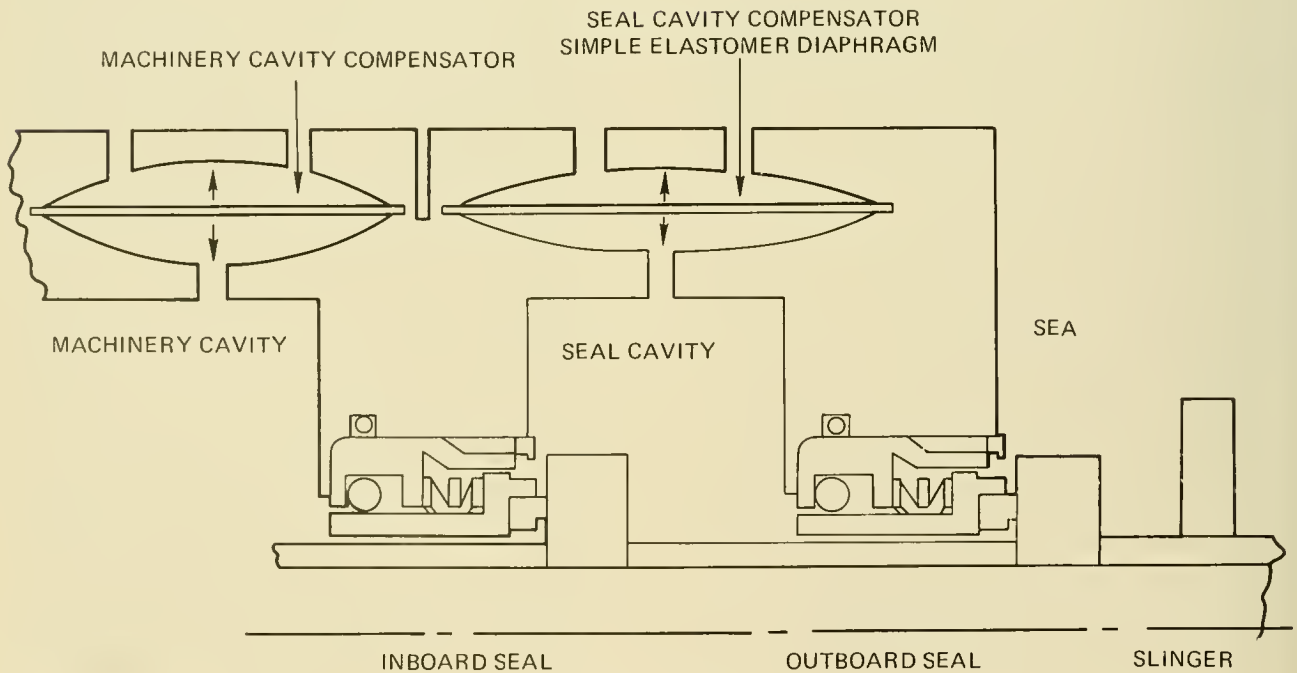

Fig. 8.21 Double seal, redundant arrangement ( $\Delta P$  Nominally Zero). (From Ref. (14))

ported and found to be due to contaminants between seal faces introduced at the assembly stage.

### Hermetically Sealed Motors:

In this design (Fig. 8.22) the electrical system is completely isolated from seawater by impregnating the stator windings in an epoxy resin and sealing the component inside a welded, corrosion-resistant metal case. The design may incorporate either oil or water as a lubricant and a shaft seal and pressure-compensation system can be employed. According to Thomas, hermetically sealed motors have successfully performed as deep as 11,500 feet and can, with minor modifications, operate successfully to 20,000 feet. He further states that this design provides maximum reliability in seawater.

The variety of commercially available electric motors is manifold and submersible builders do not appear to favor any particular brand over the other (See individual listings in Chap. 4). In a few instances they have modified the design of an off-the-shelf item to fit their own requirements, *e.g.*, Perry Submarine Builders. In other cases, such as HYCO, they manufacture their own. The shallow diving, smaller vehicles have a greater range of options than their deep-diving counterparts because of the small power requirements and reduced pressures. In the case of *KUMUKAHI*, a trolling motor from Sears & Roebuck suited the task.

A few vehicles employ electro-hydraulic motors to provide propulsive power; an example of this arrangement for *MAKAKAI* is

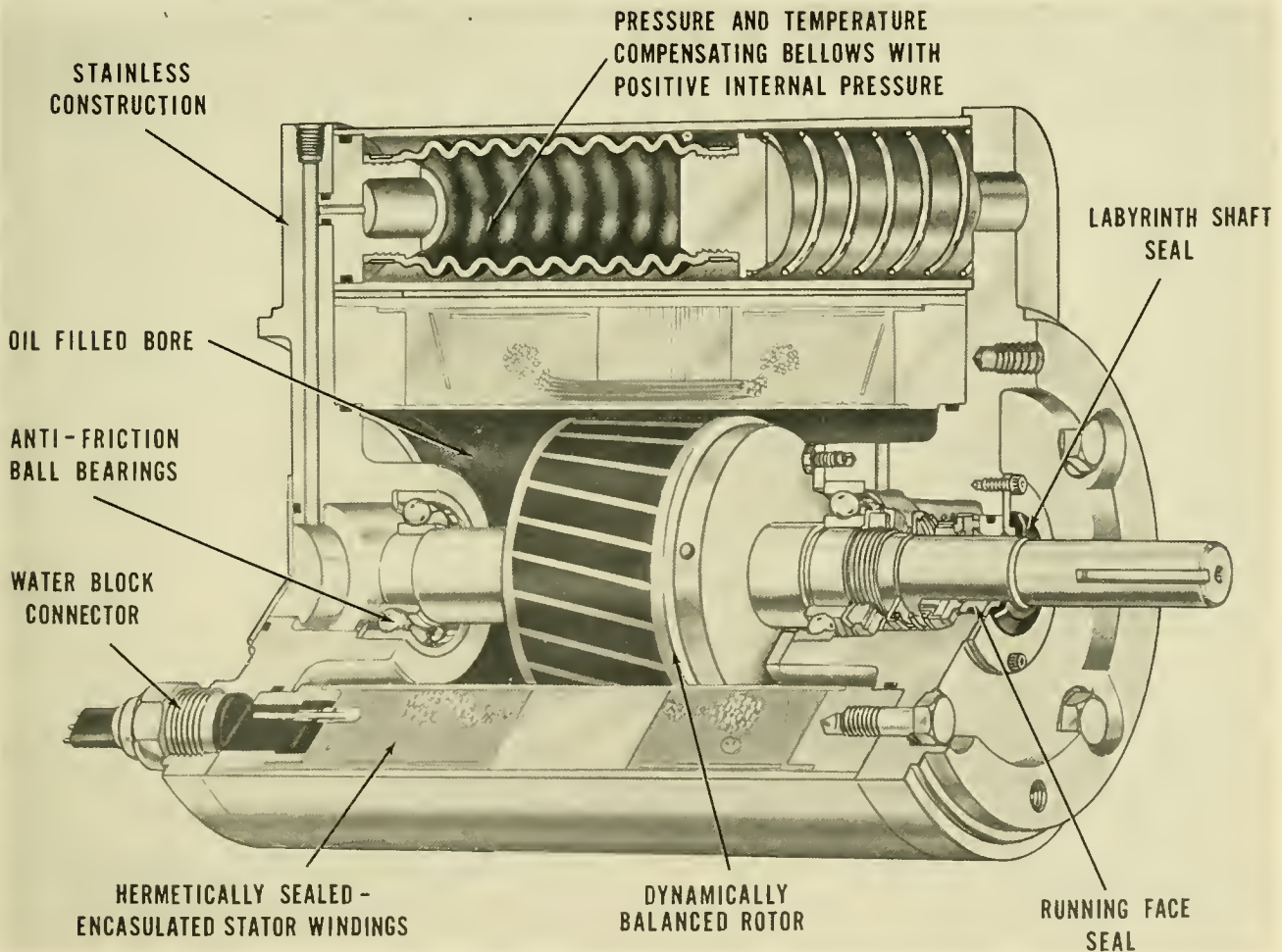

Fig 8.22 Cutaway of Franklin Electric's hermetically sealed motor with pressure compensation. (Franklin Elec. Co.)

shown in Figure 8.23. A scheme using hydraulic motors *in lieu* of direct electrical drive in **MAKAKAI** was because only one electronic control circuit would be required to control both motors; hence, simplicity. In **NEMO**, because the anchor winch only operated with hydraulic power, it was considered expedient to operate the remaining components with the same hydraulic motor. Use of hydraulic motors for propulsion is not common in past or present submersibles, and their employment is generally based on design or space constraints peculiar to a specific vehicle.

## DRAG FORCES

So far, only the forces that move a submersible have been discussed. In order to

derive the propulsive power required to move a particular vehicle, the forces acting to resist movement must also be considered.

Two forces act to restrain a submersible's movement underwater: Form drag and friction drag between the water and its skin. Quite simply, form drag is created as the water is moved outward to make room for the body and is a function of cross-sectional area and shape. Friction drag is created by the frictional forces between the skin (fairings and appurtenances) and the water.

### Form Drag

The ideal hydrodynamic shape for an underwater vehicle is a streamlined body of revolution with a single screw on the centerline as shown in the **ALBACORE**-type hull

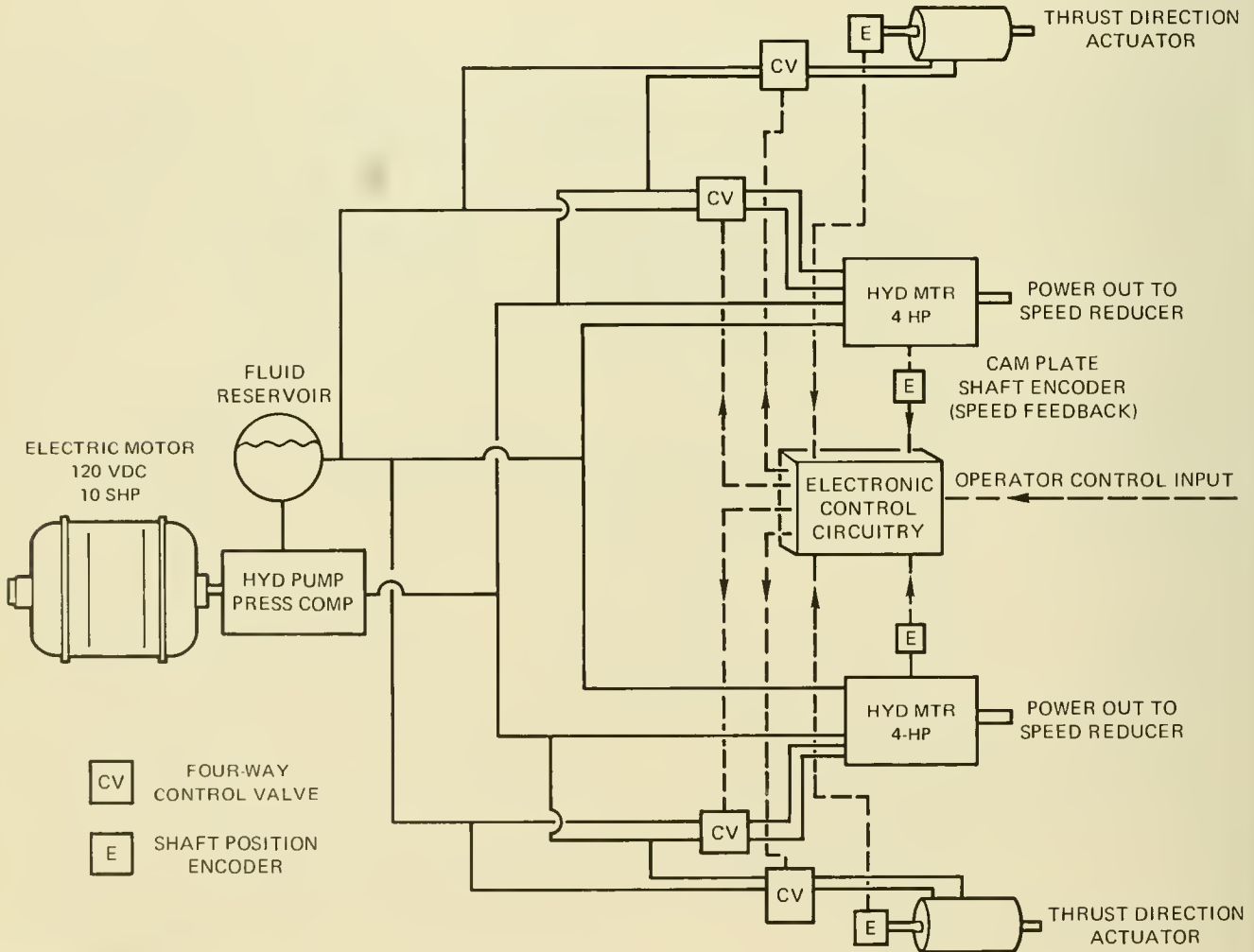

Fig. 8.23 MAKAKAI's electro-hydraulic propulsion system.



(Fig. 8.24). In this type of body there is low drag, very little wake and what drag does exist is largely that of skin friction. As is evident from Figure 8.24, the drag coefficient ( $C_d$ ) of such streamlined bodies of revolution is governed primarily by the length to diameter ratio, sometimes referred to as the “fineness” ratio and secondarily by Reynolds number of the flow.

A review of the submersible configurations in Figures 8.18 and 8.19 reveals no parallels to the **ALBACORE** hull; the closest similarity being perhaps that of the **DSRV**. Submersibles range between bluff (non-streamlined) to somewhere approaching streamlined bodies; the majority congregating towards the lower middle or bluff end of this broad category. Consequently, high form drag is prevalent.

### Skin Friction Drag

Skin friction drag is due to the viscosity of the water. Its effects are exhibited in the adjacent, thin layers of fluid in contact with the vehicle’s surface—*i.e.*, the boundary layer. The boundary layer begins at the surface of the submersible where the water is in immediate contact with the surface and is at zero velocity relative to the surface. The outer edge of the boundary layer is at water-stream velocity. Consequently, within this layer is a velocity gradient and shearing stresses produced between the thin layers adjacent to each other. The skin friction drag is the result of stresses produced within the boundary layer. Initial flow within the boundary layer is laminar (regular, continuous movement of individual water particles in a specific direction) and then abruptly terminates into a transition region where the flow is turbulent and the layer increases in thickness. To obtain high vehicle speed, the design must be towards retaining laminar flow as long as possible, for the drag in the laminar layer is much less than that within the turbulent layer.

An important factor determining the condition of flow about a body and the relative effect of fluid viscosity is the “Reynolds number.” This number was evolved from work of the Englishman Osborne Reynolds in the 1880’s who observed that what might have begun as laminar flow became abruptly tur-

bulent when a particular value of the product of the distance along a tube and the velocity divided by the viscosity was reached. The Reynolds number expresses in non-dimensional form a ratio between inertia forces and viscous forces on the particle, and the transition from the laminar to the turbulent area occurs at a critical Reynolds number value. This critical Reynolds number value is lowered by the effects of surface imperfections and regions of increasing pressure. In some circumstances, sufficient kinetic energy of the flow may be lost from the boundary layer such that the flow separates from the body and produces large pressure or form drag.

The Reynolds number can be calculated by the following:

$$Re = \frac{\rho V l}{\mu} = \frac{V l}{\nu}$$



ALBACORE Type Hull

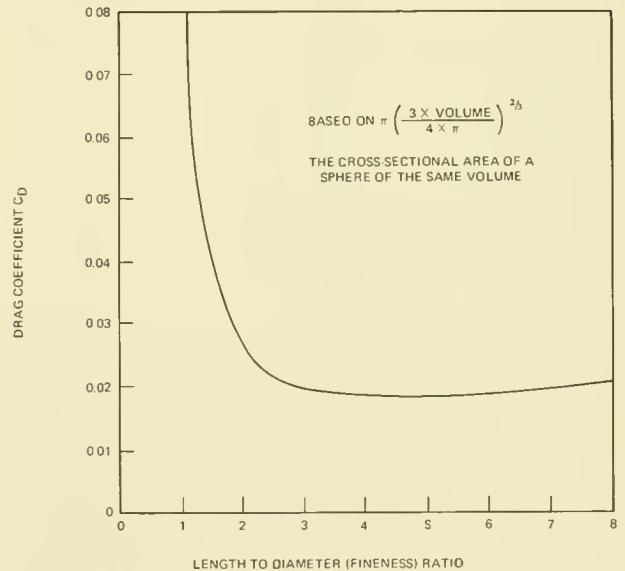
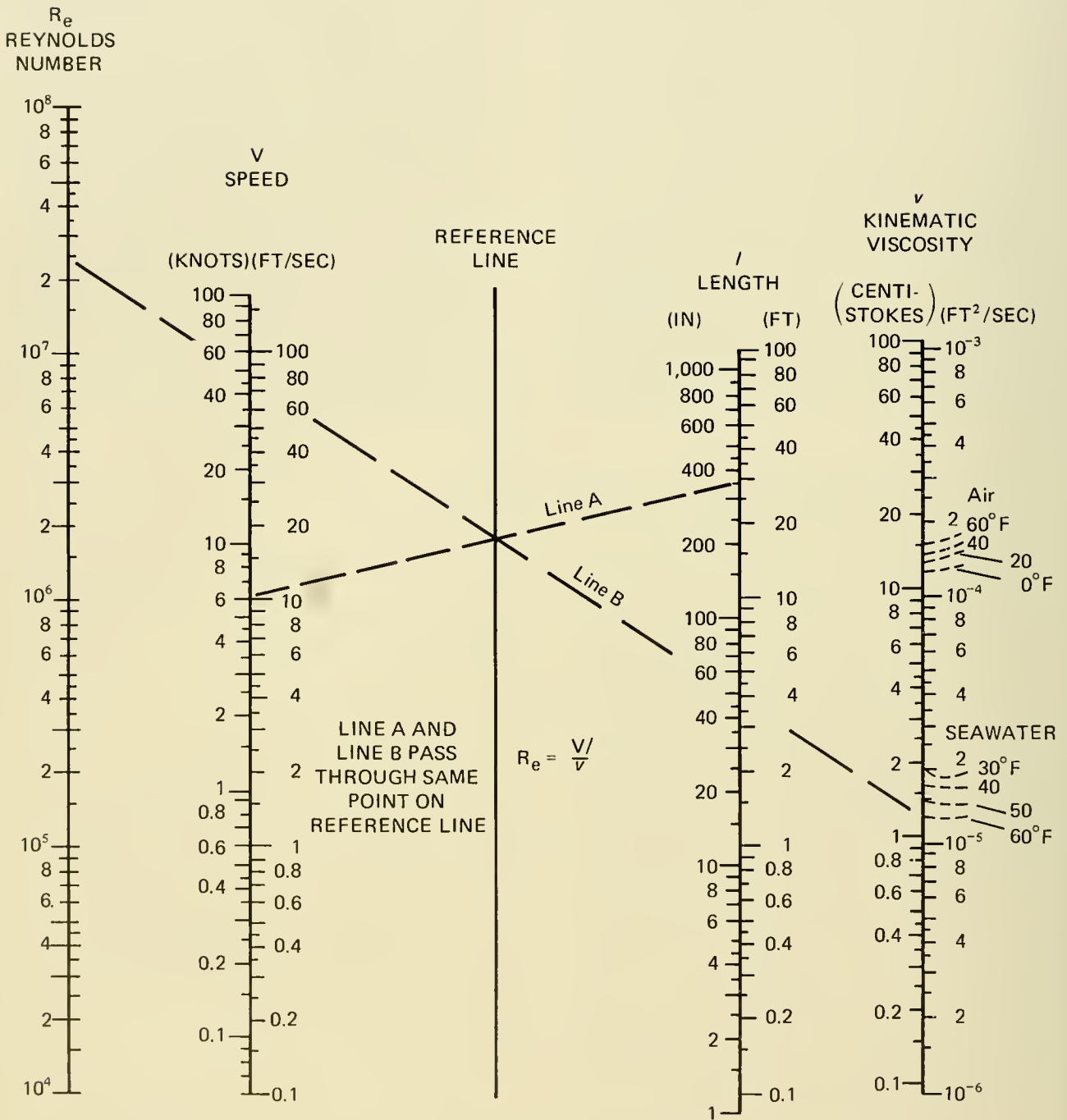

Fig 8.24 Drag coefficient of streamline bodies of revolution.



To find the Reynolds number, find the crossing point on the reference line for the product of the given speed and length; for example, line A for a velocity of 10 ft/sec and a 30-ft length. Then, using this reference point, find the quotient for the given viscosity; for example, line B for a viscosity of  $1.2 \times 10^{-5}$  (seawater at 60°F). The resulting Reynolds number is given by the intersection of line B and the Reynolds scale— $2.5 \times 10^7$  for the example.

Fig. 8.25 Nomogram for finding Reynolds Number.

where  $p$  = density of fluid (Slugs/ft<sup>3</sup>)  
 $V$  = velocity of flow (ft/sec)  
 $m$  = coefficient of viscosity (lb-sec/ft<sup>2</sup>)  
 $\nu$  =  $m/p$  = kinematic viscosity (ft<sup>2</sup>/sec)  
 $l$  = a characteristic length of the body (ft)

The Reynolds number can also be obtained from the nomogram in Figure 8.25.

An additional factor is roughness of the body surface which will increase frictional drag. Naval architects generally add a roughness-drag coefficient to the friction-drag coefficient value for average conditions.

Because a submersible rarely travels at constant speed, forces must be considered that arise from the acceleration of a mass of fluid entrained by the body or fairings. The added mass is determined by the mass density of the fluid and size, shape and motion of the body. Likewise, there is a moment of inertia accompanying angular acceleration which is also added (16). Both the former force (called virtual or induced mass) and the latter, moment of inertia, are treated under unsteady flow in hydrodynamic considerations.

While such considerations are of extreme importance to the military submarine—where high speed, among other factors, is desired—they are less important to submersibles where 2 or 3 knots generally will suffice. More important than the shape of a submersible are considerations of pressure hull size, component arrangement, maneuverability, weight saving and surface sea-keeping. Furthermore, while a particular hull shape may be hydrodynamically satisfying, the external instruments and equipment attached from dive to dive will frustrate any attempts by the hydrodynamicist to maintain a low drag coefficient. A number of the large corporations and academic institutions have derived the drag forces operating on their vehicle. One such case is *ALVIN*, for which Mavor *et al.* (8) present a moderately detailed but fully referenced account of the procedures and results. Resistance data for bodies of *ALVIN*'s shape (described as oculina) were not available at the time of its design; consequently, a one-twelfth scale model was constructed at the Massachusetts

Institute of Technology and towed by a pusher sting dynamometer. A drag coefficient of 0.027 based on its wetted-surface area was indicated. A second test on a one-quarter scale model at the Illinois Institute of Technology confirmed the 0.027 drag coefficient. For comparison purposes, a total drag coefficient for the *ALBACORE*-type hull was calculated at 0.0033. While *ALVIN* is not the most streamlined of submersibles, it is not the worst, and it might serve as a general comparison for the drag coefficient of contemporary submersibles (with a spherical bow) against a streamlined body of revolution. Interestingly, *ALVIN*'s resistance is approximately equal to that of a sphere having the same cross-sectional diameter as the hull, and the hull shape in this range of fineness ratio may not have important effects on resistance.

## PROPULSION POWER REQUIREMENTS

To derive the horsepower required of a submersible's motor two factors must be decided: What is the desired speed, and what resistance must be overcome? In most cases the designer will have fairly firm notions concerning speed, but the resistance or drag of the vehicle is not always known.

Model testing and the engineering talents required for drag and dimensional analyses, such as those performed on *ALVIN*, are expensive and far beyond the resources of the so-called "backyard builder." Furthermore, if the model tests were to show an optimum horsepower which was not available off-the-shelf, few, if any, of the smaller builders would be able to afford the cost of a specially built motor. The approach taken by the small builder to motor selection is based, in the final analysis, on availability and trial and error.

An example of the above approach is found in the *NEKTON* vehicles. According to Mr. Douglas Privitt of General Oceanographics, the procedure followed in selecting a propulsion motor for those vehicles was based on the following constraints: The motor had to be DC, series wound, small and light weight. It had to provide a speed of 2 knots at an economical current drain and be available

off-the-shelf. These constraints left very few candidates from which to select. A golf cart motor of 3.5 horsepower mounted in a pressure-resistant housing designed by General Oceanographics was selected and has been quite successful. The power for this motor was provided by golf cart batteries. Additional guidance was provided by assaying the field to see what other similarly sized vehicles were using. This approach is just as successful for the *NEKTON* vehicles of General Oceanographics as the more sophisticated approach taken by the giant Aerospace Corporation for their vehicles.

The common unit for expressing the power delivered by a motor is horsepower (hp) (one horsepower is defined as 550 ft-lb/sec). In both submersibles and surface ships the power delivered by the engine to the propeller is called shaft horsepower (SHP), and is

the product of the torque and revolutions per minute of the shaft. Another definition of SHP deducts shaft seal and bearing losses from the engine output to derive actual power delivered to the propeller (2). The power required to propel a submersible through the water is expressed as effective horsepower (EHP) and is equal to the product of the resistance in pounds and the speed (ft-lb/sec) divided by 550.

In the *ALVIN* model tests (8), the total drag ( $R_t$ ) was measured by a dynamometer at varying speeds. By performing the calculations defining EHP, the horsepower needed to propel *ALVIN* through a range of speeds was found. A plot of these values, including EHP, is shown in Figure 8.26.

Another example of deriving required horsepower was given by Daubin (18) for General Motor's *DOWB*. In these calcula-

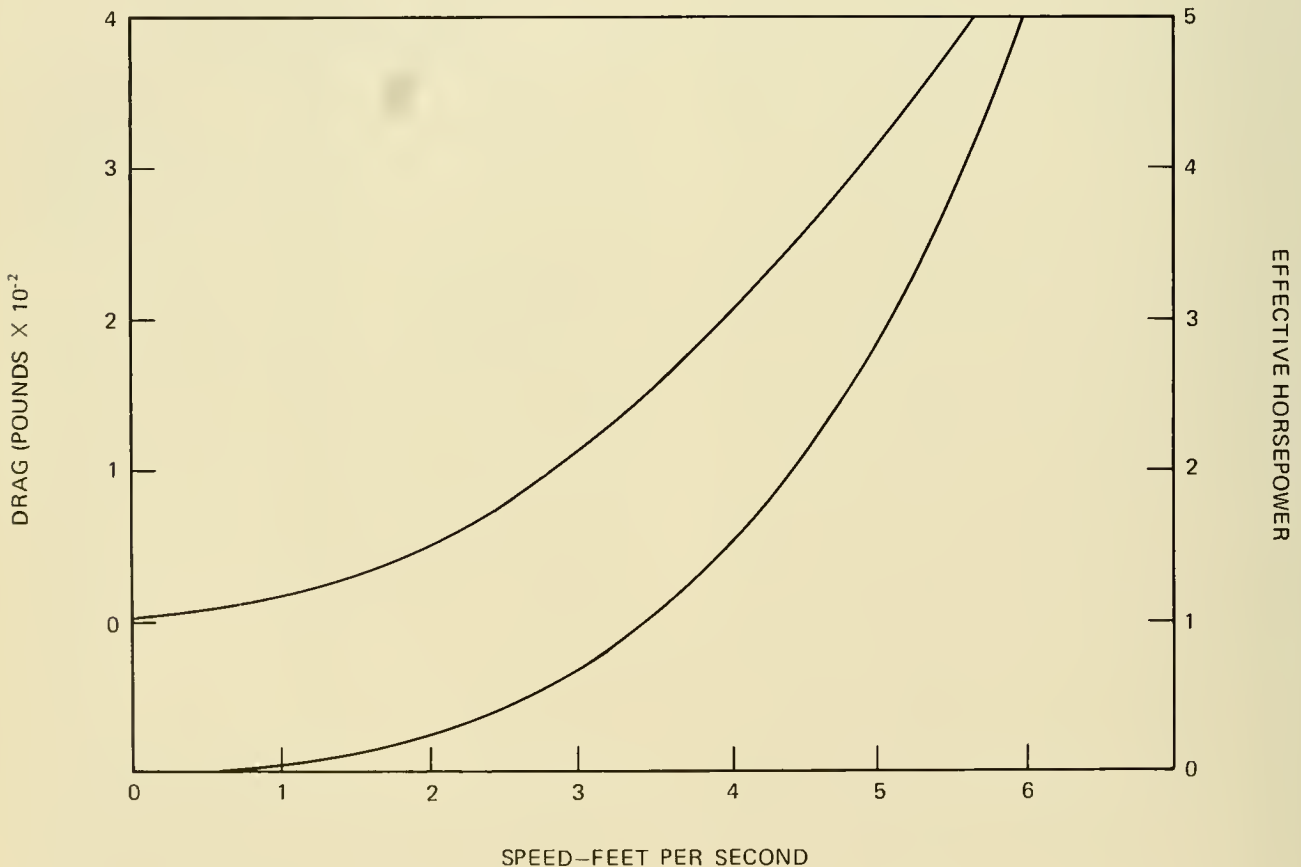

Fig. 8.26 EHP curves for ALVIN. [From Ref. (17)]

tions **DOWB's** similarities to **ALVIN** in fineness ratio, Reynolds number and shape were considered close enough to justify using the same drag coefficient of 0.027, from this was calculated: Drag, EHP and SHP.

A first approximation of SHP required to drive a submersible is presented by Rehnitzer and Gorman (19) as

$$\text{SHP} = 0.005 V^3 \Delta^{2/3}$$

where V = Speed in knots

$\Delta^{2/3}$  = propelled displacement. An approximation of the weight including water confined within the fairing: = LBD/60 in. long tons (2,240 lb); L = length, B = breadth, D = depth in feet.

From these examples it is apparent that there are several ways to determine and obtain the required SHP for a submersible: The first involves off-the-shelf availability of candidate motors and intuition, the second encompasses model testing and a variety of calculations from model tests of similarly configured vehicles. In addition there are other means proprietary to various manufacturers. Perry Submarine Builders uses a method based on past vehicle performance with various propulsion plants and, in some manner, observes drag on the vehicle itself instead of a model. (Personal communication with F. Cunningham, Perry Submarine Builders.)

Regardless of the method used to derive required SHP, the results are fairly consistent: Low SHP is the rule. Where rated horsepower data is available (58 submersibles), the following groupings are found: 1-5 hp = 50%; 5-10 hp = 35%; 10-15 hp = 9%; 15-20 hp = 2%; the remaining 4%. **AUGUSTE PICCARD** and **BEN FRANKLIN**, use 75 hp and 100 hp, respectively. (These values are for main propulsion only and do not include thruster values.) The low horsepower reflects not only the undesirability of high speed, but also the quite limited supply of electrical power which is the only power source for a variety of other tasks.

The term  $V^3$  in the above equation is a paramount consideration when high speed is desired, because it represents a heavy toll one must pay in power for merely a small increase in speed.

Consider the following for the submersible **BEAVER** which, from reference (20), has a  $\Delta^{2/3} = 15$ . If **BEAVER** is to cruise at 2 knots then by the formula:

$$\text{SHP} = 0.005 V^3 \Delta^{2/3} = 0.005 (2)^3 (15)$$

$$\text{SHP} = 0.60$$

If a 50 percent increase in speed (3 knots) is desired, then the SHP required increases to 2.03, over a three-fold increase. Let us now consider what this requires in the form of electrical power. A 0.60-hp requirement is equal to 0.45 kWh (hp  $\times$  0.745), while 2.03 hp is equal to 1.51 kWh. An increase in speed, therefore, calls for electrical power which is in competition with other tasks equal to, or exceeding, the importance of higher speed.

## CONTROL DEVICES

The means of controlling a submersible's maneuvering devices are as varied as the devices themselves. At one end of the spectrum the control is entirely manual; at the other end the necessary controls are so complex that computer assistance is necessary. Between these two extremes are combinations of manual, manual-hydraulic, electro-hydraulic and electrical. Instead of listing each and every means used on individual vehicles, which would be exhaustive, a representative selection of vehicles is described.

There is one area of commonality throughout the field: All vehicles can be controlled by one person. While several of the larger, more complex vehicles have a co-pilot, the second person is not required for basic control of the vehicle. The co-pilot serves mainly to relieve the pilot and assist in special maneuvers or functions. The similarity in tasks between an aircraft crew and the crew of a large submersible is, in many respects, very close.

While the major control functions occupying the operator are those when submerged, there are certain functions some operators must perform during launch and retrieval. The great majority of vehicles place no responsibility on the pilot during launch or retrieval other than to secure the hatch and wait until the vehicle is in the water. Once it is in the water and free of steadying lines and lift cable, the operator's work and con-

trol functions begin. In the case of both *ALVIN* and *DEEP QUEST*, however, coordination is required between the operator and support ship during both launch and retrieval. An explanation of submerged control, however, describes the same control available on the surface.

### ALL OCEAN INDUSTRIES:

The *All Ocean Industries* vehicle and the *K-250* series obtain all propulsion and maneuverability from four  $\frac{1}{2}$ -hp, 6 and 12 VDC electric motors mounted in pairs port and starboard amidships. A selector switch is provided for each motor which can be set at low, medium or high speed. Control or orientation of the motors, which rotate together or individually 360 degrees in the vertical, is quite simple: The operator merely pushes or pulls a crank-like bar connected to the motors which rotates within a thru-hull penetration (Fig. 8.27). The motors are pressure-compensated to 150 feet and produced by Phantom Motors, Kansas City, Mo. Because there are no slip rings in the rotating system, the operator must be careful not to

rotate the motors beyond 360 degrees or else he runs the risk of breaking the wires.

### *SDL-1*:

The *SDL-1* is propelled by two independently controlled motors which are mounted in the horizontal plane port and starboard. Each motor is compound wound, 120 VDC, 5 hp, reversible and drives a screw-type propeller. A 4:1 planetary reduction gear is coupled to each motor armature. Both motor casing and reduction gear housing are individually pressure-compensated. Control of each motor is obtained from a Wismer and Rawlings 50-amp, 60- and 120-VDC, 3-step reversing control unit. The throttle box is portable and may be moved about in the control (forward) pressure sphere. Two 7-step rotary switches are mounted on opposite sides of the throttlebox, providing three speeds forward, three speeds aft and neutral or OFF. The propulsion motors may be operated together or independently at any combination of speeds and in opposition. Rheostats on the motor starters provide speed adjustment over a small range to equalize propulsive thrust of both motors. Ammeters are provided to monitor currents. Schematics of *SDL-1* showing these systems were not

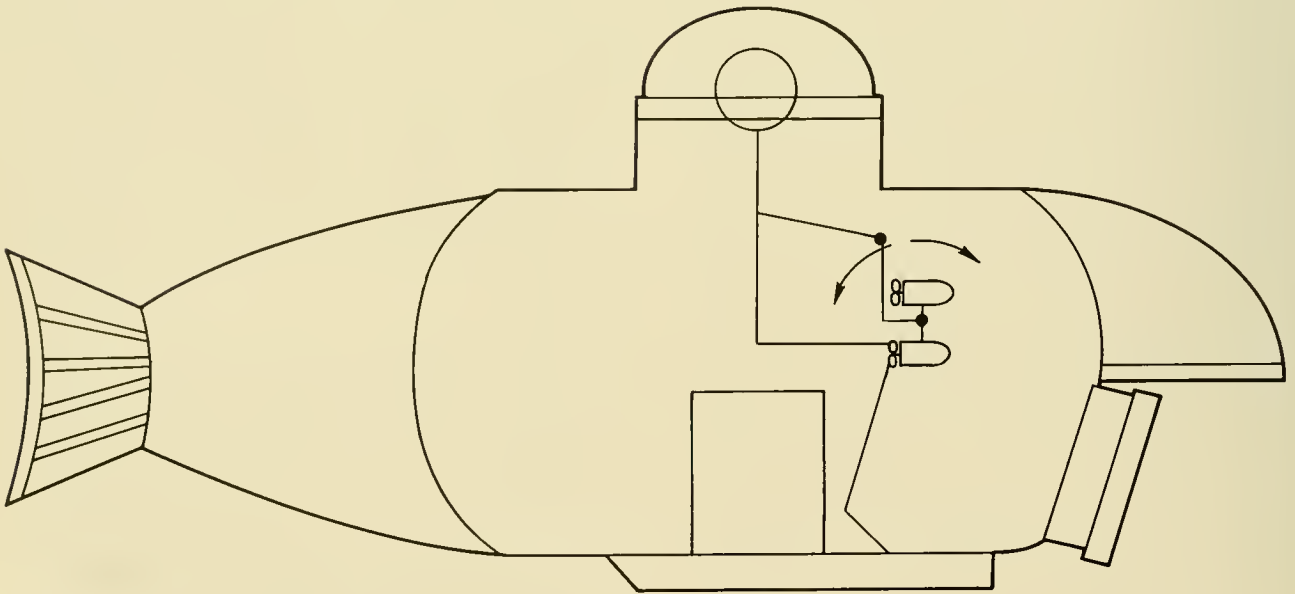

Fig. 8.27 Manual propulsion control on the K-250 series.

available. Instead Figure 8.28 presents the *PISCES* series control and propulsion system which is similar.

**PC-14:**

The Perry built *PC-14* (belonging to Texas A&M Univ.) (now *TECHDIVER*) is propelled by a 36-VDC, 7.8-amp, reversible General Electric motor. Motor speed control is by a selector switch on a portable control box which provides three speeds forward and three reverse (Fig. 8.29). The rudder and bow planes are controlled by port (for dive planes) and starboard (for rudder) levers which are manually operated and are linked by a rod and cable to the plane and rudder, respec-

tively. The cable controlling rudder movements (manufactured by Controex Corp. of America, Croton Falls, New York) is made of stainless steel and consists of a flexible housing in which a flat rod rides on ball bearings. Control mechanisms for the larger Perry-built vehicles consist of hand-held portable units (Fig. 8.30) which control all motor speeds, direction and position (for trainable units), the planes and rudder. The portable control box may also include an automatic piloting feature.

**STAR III:**

*STAR III* receives thrust power from a 7½-hp electric motor (110 VDC) and vertical and

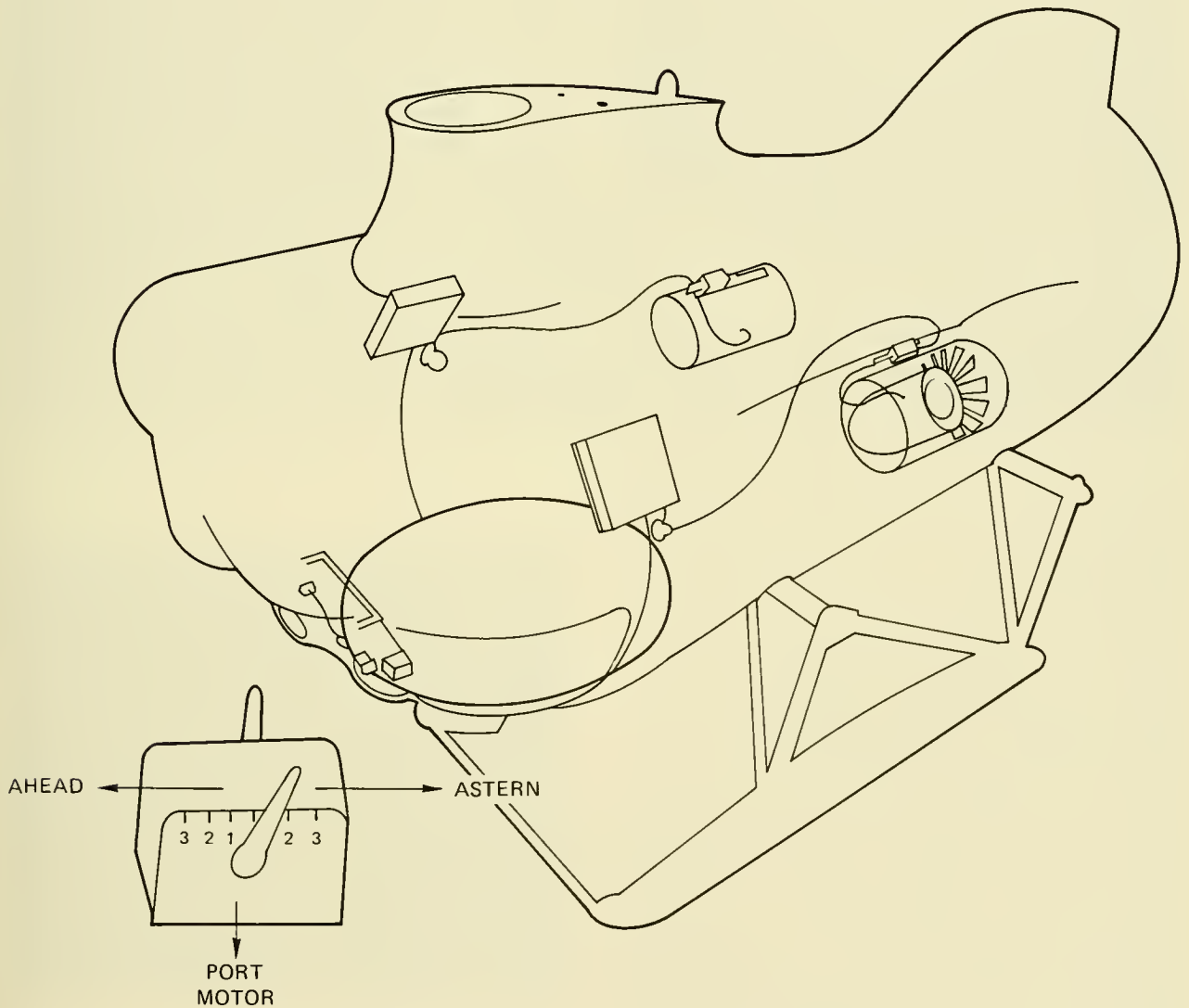

Fig. 8.28 *PISCES*' control propulsion system. (HYCO)



Fig. 8.29 Motor control unit for PC-14

lateral propulsion from two thruster motors of 2 hp each. All motors are pressure compensated and reversible, and speed control is continuously variable throughout its range. An electrically-powered rudder may be moved 35 degrees left or right by a 20-rpm, reversible gear motor enclosed in a pressure-compensated box. To control these devices *STAR III* has both fixed and portable controls. The fixed controls (Fig. 8.31) and push-buttons are mounted on the starboard side. To operate the thrusters the buttons must be constantly depressed, if not, they return to stop (so-called "deadman" control). There are no provisions for rudder maneuvering on the fixed controls. The portable control box has a joystick for forward-reverse and left-right control, a separate lever for vertical thruster control and two toggle switches for left/right rudder control. The thruster controls provide for continuously-variable speed and must be reset to neutral or stop. A rudder angle indicator is incorporated into the portable control box. It may seem a small matter whether or not a button remains in when it's been pushed or returns to its "stop" position

when released, but it must be remembered that if a deadman-type control is used then the operator can do nothing else with his hands while pushing the button. In a small submersible, where the crew consists of one or two people, a multitude of recurring and concurrent tasks is required of these limited resources. Such demands on the occupants must be considered in designing control devices.

**BEAVER:**

International Underwater Contractors' *BEAVER* receives all maneuvering capability from three, 5-hp each, reversible, pressure-compensated, DC motors. Control of these motors, which are rotatable through 360 degrees in the vertical, is through a primary and backup system, both of which are hand-operated and fixed. *BEAVER's* primary control system possibly typifies the most one can do with one hand in vehicle maneuvering, without requiring the assistance of a computer. Both control system components are shown in Figure 8.32, and the primary control system is shown in Figure 8.33. At operating depth with the joystick neutralized and motors stopped, the ballast control buttons bring *BEAVER* to neutral trim. Forward or reverse motion is obtained by pushing the joystick forward or

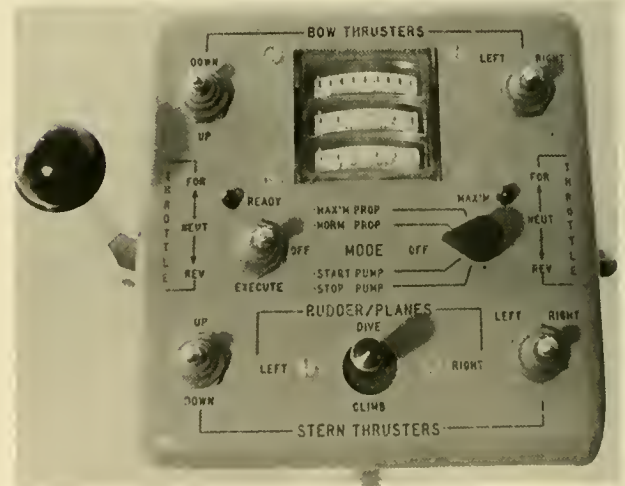

Fig. 8.30 The portable control box for VOL-L1 Designed and built by Perry Submarine Builders. (Perry Submarine Builders, Inc.)



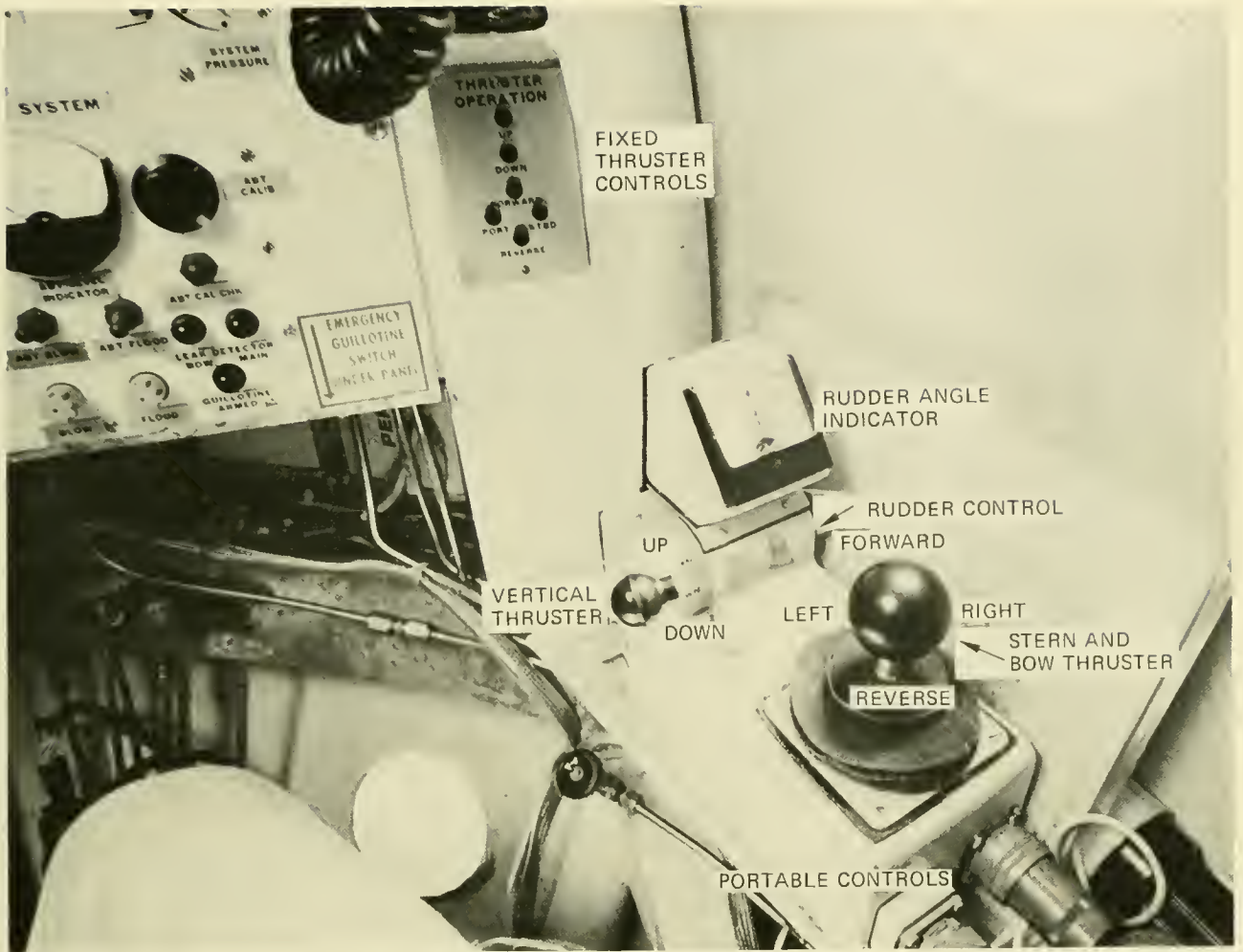

Fig. 8.31 STAR III's portable and fixed controls. (NAVOCEANO)

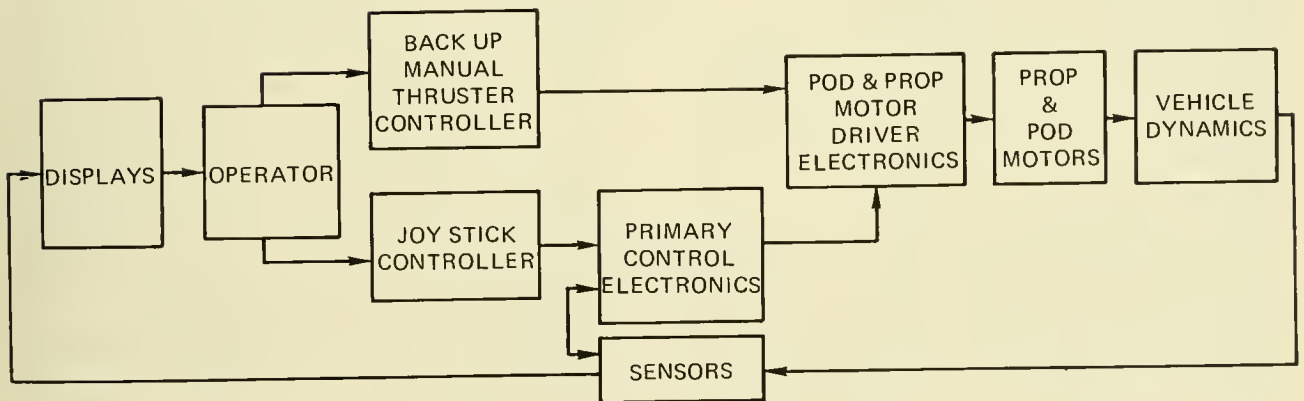

Fig. 8.32 Primary and backup control components of BEAVER.

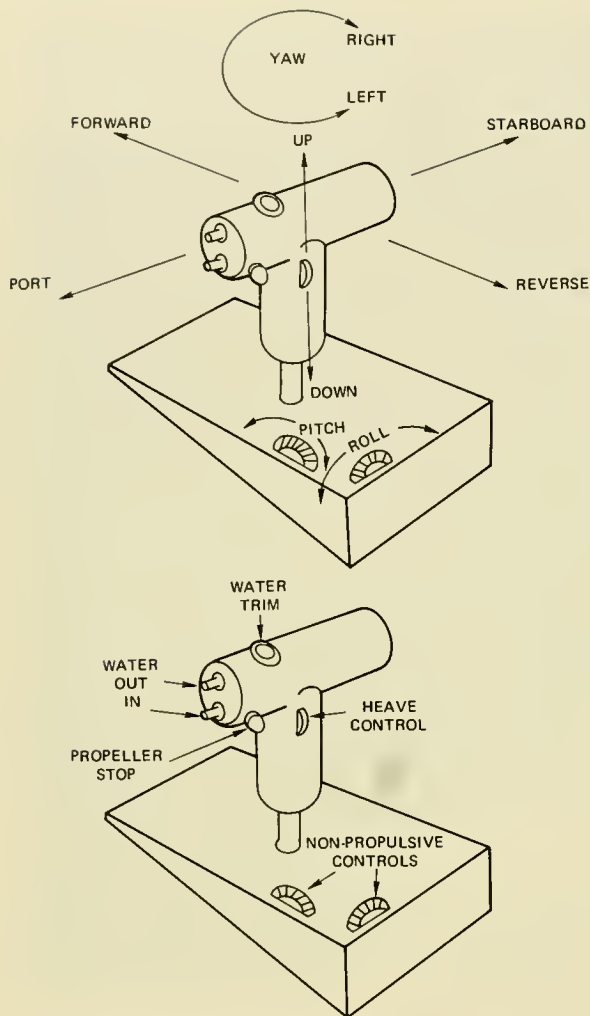

Fig. 8.33 Primary motor and variable ballast and pitch/trim control on BEAVER.

pulling back. Side motion is effected by pushing the joystick in the desired direction of movement. Directional changes are effected by twisting the joystick. Depth and attitude changes are commanded by rotating the trim wheels. For emergencies, the propellers can be stopped or reversed by pressing override buttons.

An unusual aspect of this control system is the incorporation of the variable ballast control in the same component with the motor controllers. The majority of vehicles locate ballasting controls completely separate from the motor controller. The backup control system is adjacent to the primary system and allows independent pod rotation and motor

rpm control. Control in the backup mode permits most maneuvers with the primary system but requires more operator attention.

#### ALUMINAUT:

Vehicles as large as **ALUMINAUT**, **AUGUSTE PICCARD** and **BEN FRANKLIN** are generally operated by both pilot and co-pilot. In the first two vehicles a third crewman acts as engineer or, more precisely, electronic technician. **AUGUSTE PICCARD** had all controls in the bow hemi-head where both pilot and co-pilot were stationed. **BEN FRANKLIN's** control station was slightly aft of the bow on the port side and, when cruising near the bottom, the co-pilot operated the controls on voice command from the pilot who maintained visual contact with the bottom from one of the forward viewports. **ALUMINAUT** operated similarly to **BEN FRANKLIN**, except that the pilot had the option of controlling the vehicle from his forward position with a portable control unit. **ALUMINAUT** received thrust and yaw from two reversible, 115- and 230-VDC motors of 5 hp each and heave from a motor mounted atop the vehicle with similar characteristics. Stern planes and rudder were moved by a 1/4-hp electric motor. The primary control panel (Fig. 8.34) contains individual controls for all thrusters, planes and the rudder, in addition to motor monitoring devices (amperage, rpm's, etc.). Motor speed for both forward and reverse movement is 1/3, 2/3 and full. Pitch control, by transfer of water fore or aft, is also incorporated in this panel's trim pump control. The portable control box (Fig. 8.35) incorporates all features of the primary control panel except monitoring devices and trim control.

#### DSRV-1 & 2:

The U.S. Navy's rescue vehicles have the most sophisticated control system in manned submarines. Called ICAD (Integrated Control and Display) it is likened to the control and navigation system used in the **APOLLO** spacecraft system (Fig. 8.36). The ICAD system is complex and its research and development cost is reckoned in the millions of dollars. An ICAD simulator is located at San Diego where candidate **DSRV** operators undergo a several-week course to learn of its operation before they are confronted with the actual **DSRV's** themselves. A description

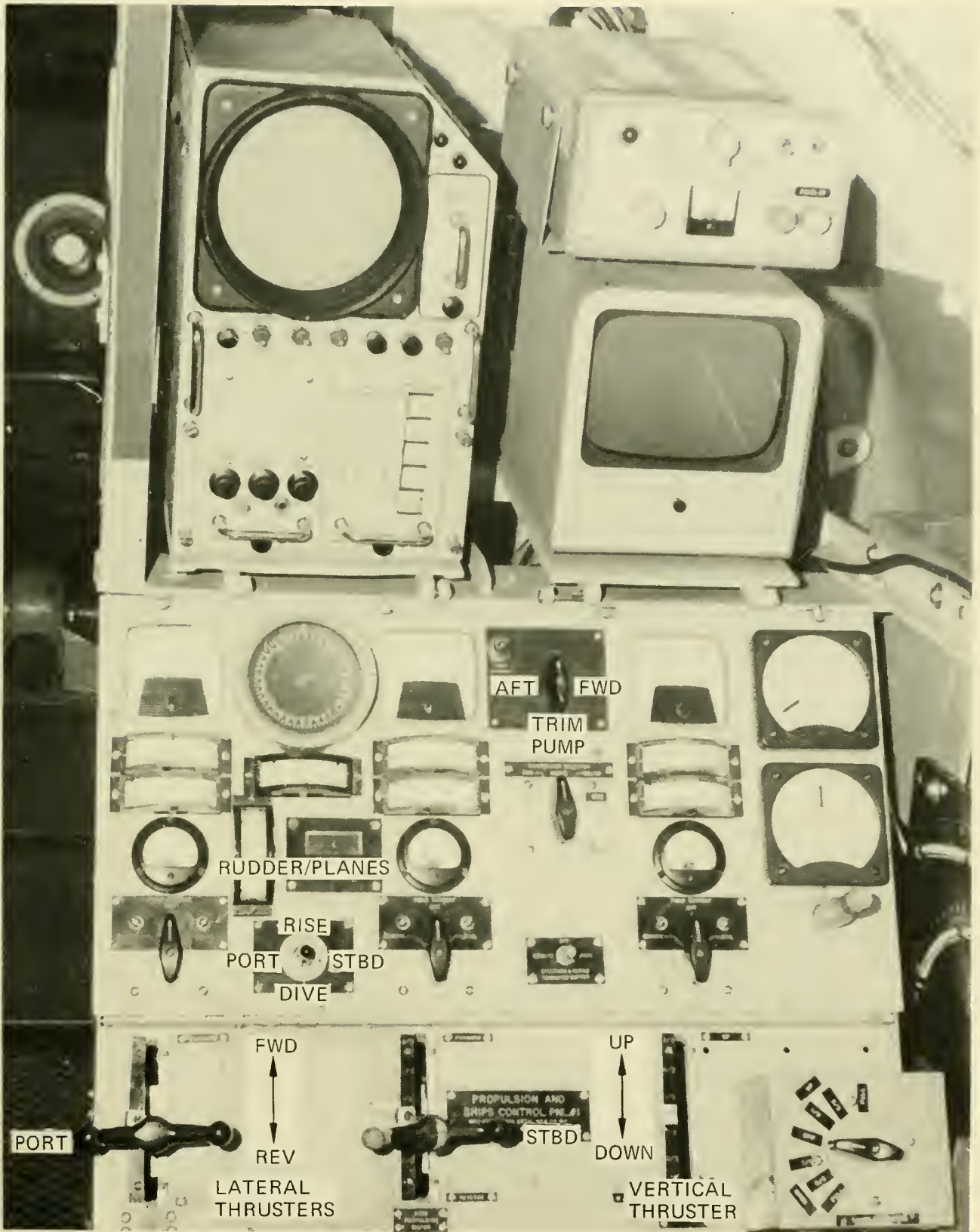

Fig. 8.34 ALUMINAUT's primary control panel. (NAVOCEANO)

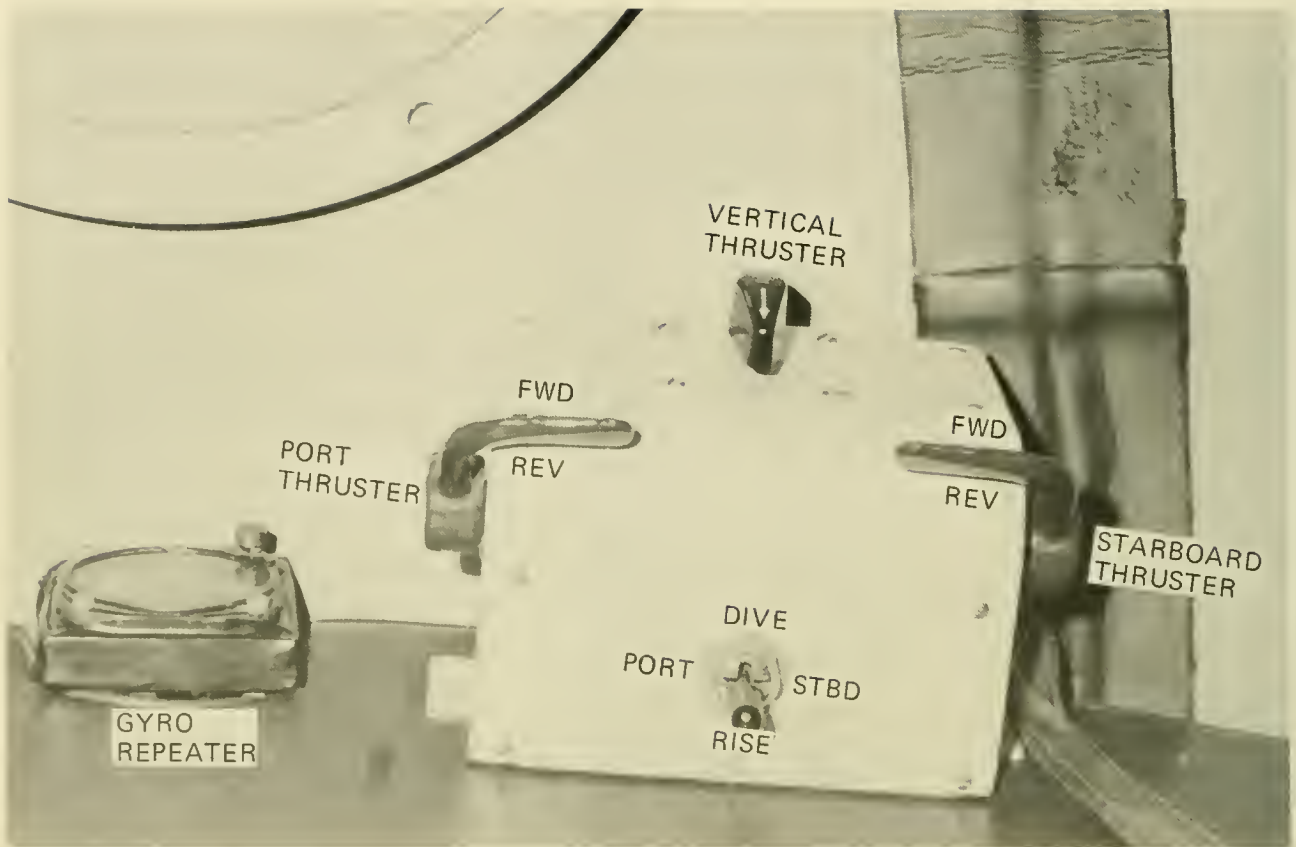

Fig 8.35 ALUMINAUT's portable control unit and forward gyro-repeater. (NAVOCEANO)

of the ICAD is not merely the subject of a book itself, it is the subject of three large volumes which cover installation, operation, troubleshooting and maintenance. Hence, the description herein will merely acquaint the reader with ICAD's existence.

The heart of the ICAD is a digital computer which integrates signals from the *DSRV*'s sonars and from the other data-gathering and producing devices, including a miniature precision inertial platform. The computer serves as a central processor which displays pertinent information to the *DSRV* operators.

With the aid of visual and aural displays from the ICAD, the operators make the necessary command decisions and activate the vehicle's controls. Two hand controllers control vehicle maneuverability with the ICAD translating the operator's commands into the proper signals to the various propulsion and control mechanisms to provide the precise reaction.

The development of ICAD was undertaken to minimize work and assist the operator during the intricate *DSRV* mission. A typical rescue mission cycle for a *DSRV* is graphically outlined in Chapter 15 and under certain conditions—*e.g.*, where a stricken submarine is listing with an up or down bow angle and high currents and low visibility prevail—the ability of a human to direct the *DSRV* and respond to the environmental dynamics is exceeded. By integrating the controls and displays, the ICAD system reduces the situation to within the limits of human capabilities.

The operator's console shown at the top of Figure 8.36 is too complex to be shown in detail, hence the major panel components are presented at the bottom of the figure. *DSRV* maneuvering is realized through the operation of the two joysticks in the ship control panel; translational motions (thrust, heave, sidle) are obtained from the left stick and rotational motions (yaw, roll, pitch) from

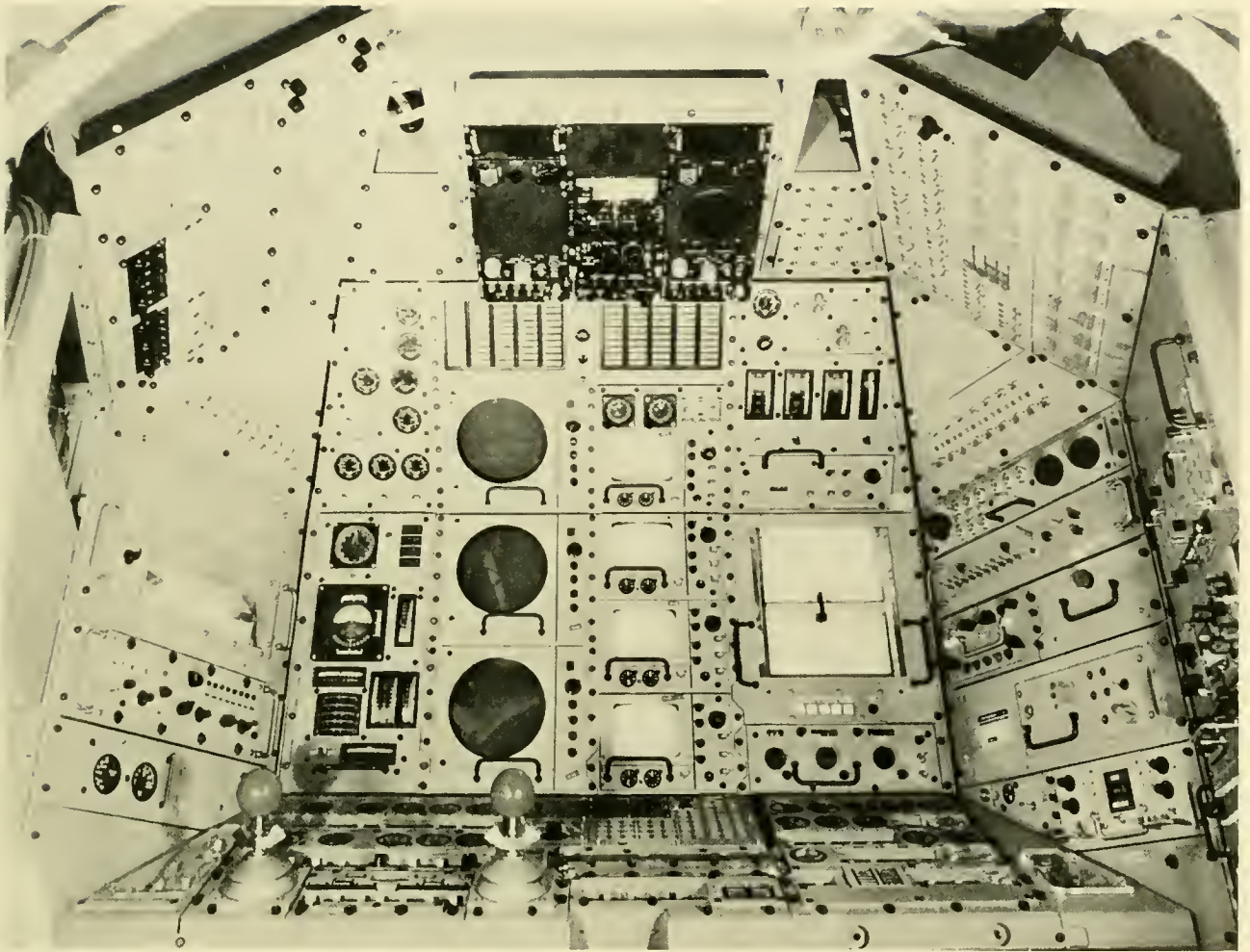
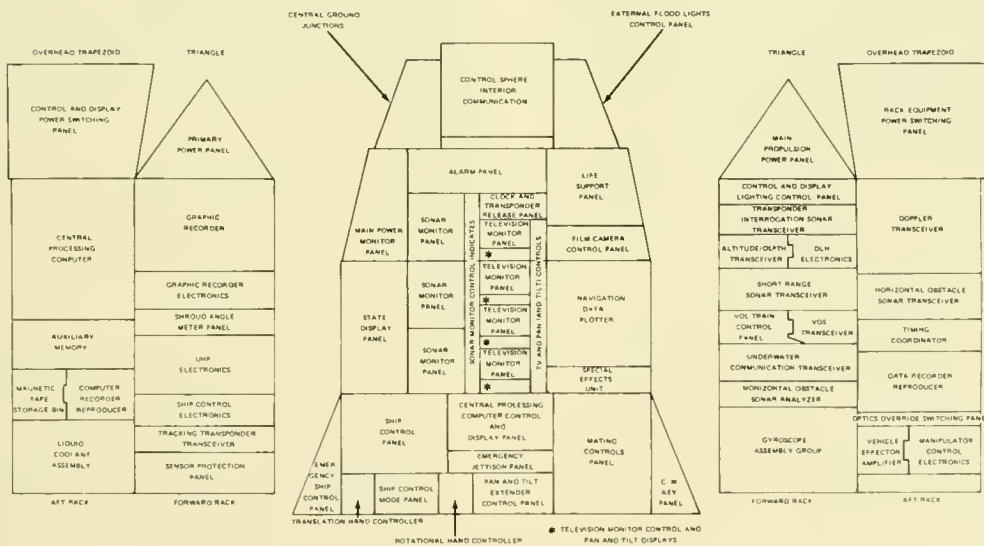

Fig. 8.36 The integrated control and display system on the DSRV's. (U.S. Navy)



the right stick. The information shown on the ICAD can be seen from the labels on the general component layout.

Of the seven control systems described, combinations thereof may be found in sister submersibles. It has been emphasized repeatedly that a number of options are available to the operator to gain more motions than the control system alone provides. While the ICAD system is a wonder of technology, it is unnecessary for the kind of maneuverability required of most submersibles. Indeed, an ICAD system wouldn't fit in the majority of vehicles, and its cost alone exceeds many times that of all but one or two government-owned submersibles.

With operational experience many of the propulsion and control devices listed in this chapter were found unnecessary on some vehicles and inadequate on others. *STAR III*, for example, eventually discontinued using its rudder because it was awkward and slow to react and adequate control could be obtained by the thrusters alone. Because the majority of submersibles were one-of-a-kind prototype models, they reflected the designers' best initial thoughts on propulsion and control and the then state-of-the-art in available hardware. Because few vehicles are similar in design and mission, there are only broad precedents on which to draw, and, in many instances, the operating life of the vehicle was too short to evolve the "best" approach to maneuvering and control.

The benefits a submersible may gain under an extended operational life is related by Goudge (21). In this example the submersible *PISCES II* had worked for some time in the areas off Victoria, B.C., where strong currents were not a severe operational consideration, but with its transfer to the North Sea, that harsh environment brought to light deficiencies theretofore unappreciated.

*"A speed of some four knots was expected for PISCES II, but the craft was so unstreamlined and the appendages caused so much drag, that 1 1/4 knots only was achieved. This and the fact that three steps of speed control only was provided, which meant that steering by differential use of the screws was very imprecise, caused*

*great difficulties in maneuvering in strong currents which are common round Britain and even in the middle of the North Sea. The first stage was to measure the bollard pull and, by spring balance, the towing pull needed to produce 1 1/4 knots. From this, the overall efficiency was found to be 14 percent. By fitting cowling extensions and flow straighteners this was raised to 28 percent. A false buoyant nose was fitted forward, Thyristor controls were provided to give stepless speed control and the motor windings altered from compound to series, with higher ratio gear box between motors and propellers.*

*The net result of all these has been to push the top speed up to 4.1 knots on the log with an overall efficiency of some 60 percent. Water tunnel tests at Newcastle University have also showed the way to still further improvements should these become economic. The costs of the greater streamlining that would be needed are quite heavy.*

*During the above improvements, opportunity was taken to try improved brushes, gear and operating fluid (the motors run at ambient sea pressure in a special oil). Taken all together, the above measures have reduced a heavy maintenance load to almost nil, mean time between failures having changed from a few hours to a still unknown but very large number. (The only failure since, in several hundred hours of running, has been a cable fault.)"*

Such modifications and improvements are commonplace in submersibles, and more can be expected as they find wider ranging and longer undersea employment.

## REFERENCES

1. Strasburg, D. W. 1965 *A submarine for research in fisheries and oceanography*. Trans. Mar. Tech. Soc. and Amer. Soc. Limnology and Oceanog., 14-17 June 1965, Wash., D.C., v. 1, p. 568-571.
2. Taggart, R. 1969 *Marine Propulsion*. Gulf Pub. Co., Houston, Tex., 368 pp.

3. Abkowitz, M. A. 1969 *Stability and Motion Control of Ocean Vehicles*. M.I.T. Press, Cambridge, Mass., 190 pp., 6 appendices.
4. Mandel, P. 1969 *Water, Air and Interface Vehicles*. M.I.T. Press, Cambridge, Mass.
5. *Principles of Naval Architecture* 1967 edited by J. P. Comstock. Pub. by The Society of Naval Architects and Marine Engineers, N. Y., 827 pp.
6. Taggart, R. 1968 *Dynamic positioning for small submersibles*. Ocean Ind., v. 3, n. 8, p. 44-49.
7. Miller, R. T. 1969 *Vessels and floating platforms*. in, *Handbook of Ocean and Underwater Engineering*. McGraw-Hill Book Co., N. Y., p. 920-963.
8. Mavor, J. W., Froehlich, H. E., Marquet, W. M. & Rainnie, W. O. 1966 *ALVIN, 6000-ft. submergence research vehicle*. Paper presented at the Ann. Meeting, N. Y., Nov. 10-11, 1966 of The Soc. of Naval Architects and Marine Engineers, n. 3, 32 pp.
9. Johnson, V. E. & Barr, R. A. 1965 *Propulsion of deep diving submarines*. Tech. Paper presented at the 5-7 May 1965 ASME Underwater Tech. Conf., New London, Conn., 29 pp.
10. Talkington, H. R. & Murphy, D. W. 1972 *Transparent Submersibles and the MAKAKAI*. U.S. Naval Undersea Center, Rept. NUC TP 283, 24 pp.
11. Greenert, W. Ocean Engineering Support Division, Naval Materials Command. (Personal communication).
12. Pritzlaff, J. A. 1970 *DEEPSTAR 20,000*. Preprints 6th Ann. Conf. & Exhibition, Mar. Tech. Soc., 29 June-July 1, 1970, Wash., D.C., v. 2, p. 817-836.
13. Wozniak, J., Taft, C. K. & Alperi, R. W. 1972 "*Wake Steering*" *A new approach to propulsion and control*. Preprints 8th Ann. Conf. & Expo., Mar. Tech. Soc., 11-13 Sept. 1972, Wash., D.C., p. 681-696.
14. Sasdelli, K. R. & Spargo, J. D. 1971 *Rotary Shaft Seal Selection Handbook for Pressure-Equalized, Deep Ocean Equipment*. U.S. Naval Ship Research and Development Center, Wash., D.C., 71 pp.
15. Thomas, L. A. 1968 *Designing propulsion motors for undersea craft*. Undersea Tech., Feb. 1968, p. 24-47; 52.
16. King, D. A. 1969 *Basic hydrodynamics*. in, *Handbook of Ocean and Underwater Engineering*. McGraw-Hill Book Co., N. Y., p. 2-1 through 2-32.
17. Torda, T. P. & Hermann, W. 1964 *Stability and Drag Experiments With a Quarter-Scale Model of the ALVIN Oceanographic Submarine*. Illinois Institute of Tech. Rept. (in ref. (5) above).
18. Daubin, S. C. 1967 *The Deep Ocean Work Boat (DOWB) An Advanced Deep Submergence Vehicle*. TR67-33; AC Electronics-Defense Research Laboratories, Santa Barbara, Calif., 14 pp.
19. Rechnitzer, A. B. & Gorman, F. T. 1969 *Submersibles*. in, *Handbook of Ocean and Underwater Engineering*. McGraw-Hill Book Co., N. Y., p. 9-63 through 9-80.
20. Bodey, C. E. & Friedland, N. 1966 *Naval Architecture of Submarine Work Boats for Offshore Work*. Proc. of Offshore Exploration Conf., p. 105-121.
21. Goudge, K. A. 1972 *Operational Experience with PISCES-Submersibles*. Conf. Papers Oceanology International 72, Brighton, England, p. 270-273.







# 9

## LIFE SUPPORT AND HABITABILITY

In order to survive and function efficiently within their sealed chamber, the submersible's occupants require a supply of food and oxygen and removal or storage of toxic gasses which they and their equipment generate. Survival, however, is only the first requirement; the second is the ability to work efficiently and comfortably. The first requirement is termed life support and the second may be referred to as habitability.

While there is overlapping between life support and habitability, a distinction is made between the requirements and procedures to support life versus the quality of life. In engineering circles, the latter subject is termed "Human Factors" and it not only

embodies comfort, but safety and efficiency as well.

### LIFE SUPPORT

In designing a submersible life support system a "Standard Man" may be used ; the characteristics of this hypothetical human are presented in Table 9.1. According to the Marine Technology Society's Undersea Vehicle Committee (1), the values are conservative and their use in designing a life support system will usually result in a system with satisfactory performance. The standard man's values are predicated on the assumption that he will be engaged in very light

TABLE 9.1 THE "STANDARD MAN" FOR LIFE SUPPORT SYSTEM DESIGN COMPUTATIONS  
[FROM REF. (1)]

Item	Quantity	Units
Oxygen Consumption	0.9	Ft <sup>3</sup> /hr at 760 mm Hg
Respired Air	18.	Ft <sup>3</sup> /hr at 760 mm Hg
Drinking Water	6	Pounds/day
Food, Dry	1.4	Pounds/day
Respiration Quotient	.85	Volume of CO <sub>2</sub> produced to O <sub>2</sub> consumed
CD <sub>2</sub> Produced	.77	Ft <sup>3</sup> /hr at 760 mm Hg
Water Vapor Produced	4	Lb/day
Urine	4	Lbs/day
Feces	0.4	Lb/day
Flatus	0.1	Ft <sup>3</sup> /day
Heat Output		
Sensible	250	Btu/hr
Latent	220	Btu/hr
Total	470	Btu/hr

work; this does not take into account the likelihood of increased oxygen consumption and carbon dioxide production under stress conditions.

While a healthy individual's survival requirements and metabolism may vary quantitatively from those of the standard man, they do not vary qualitatively, and because of the biological commonality from person-to-person, all submersible life support systems supply the following: Oxygen replenishment and carbon dioxide removal. Some vehicles have the means to remove atmospheric contaminants other than carbon dioxide, such as carbon monoxide and other gasses which fall under the category of trace contaminants. Only a few have the means to control temperature and humidity within the pressure hull. On the other hand, all can accommodate a lunch bag and thermos to supply food and water, and all have some means of storing

human wastes. If these requirements are tabulated, the following is necessary to maintain a viable environment in a submersible:

- Replenishment:** Oxygen  
Food/Water  
Emergency Air
- Removal:** Carbon Dioxide  
Trace Contaminants  
Human Wastes
- Control:** Temperature\*  
Humidity\*  
Monitoring Devices

The emergency air supply in submersibles is dealt with in Chapter 14 and is not discussed further here. Preliminary, however, to a discussion of the above factors is the length of submergence, and Table 9.2 shows that the build-up of atmospheric contaminants which can be tolerated is directly re-

**TABLE 9.2 MAXIMUM ALLOWABLE CONCENTRATION OF SOME  
SUBSTANCES IN SUBMERSIBLES [FROM: REF (3)]**

Compound	Chemical Formula	Suspected Source	1-Hr Limit	24-Hr Limit	90-Day Limit
Acetylene	C <sub>2</sub> H <sub>2</sub>		6000 PPM	6000 PPM	6000 PPM
Acrolein	CH <sub>2</sub> CHCHO	Cooking	*	0.1 PPM	*
Arsine	AsH <sub>2</sub>	Battery Gassing Scrubbers	*	0.1 PPM	0.01 PPM
Ammonia	NH <sub>3</sub>	(Metabolic)	400 PPM	50 PPM	25 PPM
Benzene	C <sub>6</sub> H <sub>6</sub>	Solvents	*	100 PPM	1.0 PPM
Carbon Dioxide	CO <sub>2</sub>	Metabolic Smoking	19 mm Hg	7.6 mm Hg	3.8 mm Hg
Carbon Monoxide	CO	(Metabolic)	200 PPM	200 PPM	25 PPM
Chlorine	Cl <sub>2</sub>	(Chlorate Candles) Polyethylene	*	1.0 PPM	0.1 PPM
Ethylene	C <sub>2</sub> H <sub>4</sub>	Decomposition Cooking	*	*	*
Formaldehyde	HCHO	Combustion	5 PPM	5 PPM	5 PPM
Freon 12	CCl <sub>2</sub> F <sub>2</sub>	Air Conditioning	2000 PPM	1000 PPM	200 PPM
Freon 11	CCl <sub>3</sub> F	Air Conditioning	50 PPM	20 PPM	5 PPM
Freon 114	CClF <sub>2</sub> CClF <sub>2</sub>	Air Conditioning	2000 PPM	1000 PPM	200 PPM
Hydrocarbons	Total Aromatic (Less Benzene) Total Aliphatic (Less Methane)	Paints & Solvents Paints & Solvents	*	*	10 mg/m <sup>3</sup> 60 mg/m <sup>3</sup>
Hydrogen	H <sub>2</sub>	Battery Gassing	1000 PPM	1000 PPM	1000 PPM
Hydrogen Chloride	HCl	Freon Decomposition	10 PPM	4 PPM	1.0 PPM
Hydrogen Fluoride	HF	Freon Decomposition	8 PPM	1.0 PPM	0.1 PPM
Mercury	Hg	Instruments	*	2.0 mg/m <sup>3</sup>	0.01 mg/m <sup>3</sup>
Methane	CH <sub>4</sub>	Sanitary Tanks	13,000 PPM	13,000 PPM	13,000 PPM
Methylalcohol	CH <sub>3</sub> OH	Cigarette Smoke	*	200 PPM	10 PPM
Methyl Chloroform	CH <sub>3</sub> Cl <sub>3</sub>	Adhesives & Solvents	25 PPM	10 PPM	2.5 PPM
Monethanolamine	HOCH <sub>2</sub> CH <sub>2</sub> NH <sub>2</sub>	CO <sub>2</sub> Scrubbers	50 PPM	3.0 PPM	0.5 PPM
Nitrogen	N <sub>2</sub>	Air	As Required	As Required	As Required
Nitrogen Dioxide	NO <sub>2</sub>	Contaminant or Hot Surfaces	10 PPM	1.0 PPM	0.5 PPM
Nitricoxide	NO	Contaminant or Hot Surfaces	10 PPM	1.0 PPM	0.5 PPM
Oxygen	O <sub>2</sub>		130 mm Hg Min.	130 mm Hg Min.	130 mm Hg Min.
Ozone	O <sub>3</sub>	Precipitators Commutators Etc.	1.0 PPM	0.1 PPM	0.02 PPM
Phosgene	COCl <sub>2</sub>	Freon Decomposition	1.0 PPM	0.1 PPM	0.05 PPM
Stibine	SbH <sub>3</sub>	Battery Gassing	*	0.05 PPM	0.01 PPM
Sulfur Dioxide	SO <sub>2</sub>	Oxidation Sanitary Tank Gases	10 PPM	5.0 PPM	1.0 PPM
Triary Phosphate		Compressors	*	50 mg/m <sup>3</sup>	1.0 mg/m <sup>3</sup>

\*No value has been assigned

lated to time of exposure. For this reason there are widely varying approaches concerning what should be replenished, removed or measured during a dive. On one end of the spectrum is the *K-250* series in which the builder relies upon hourly surfacing to refresh cabin air. On the other end is *BEN FRANKLIN* which supplies virtually every means to monitor and control cabin air and store waste products. Both of these approaches are discussed more fully in a later section; however, the majority of vehicles fall somewhere between these two extremes.

### Replenishment

Within this category are consumables which the occupants require during submergence to survive and perform their tasks. The first of these, oxygen, is required during any submergence longer than an hour or two (depending on pressure hull volume); the second, food and water, may or may not be required on a routine dive of one or more hours duration, but they are generally carried.

#### Oxygen:

At atmospheric pressure, the recommended oxygen concentration within a pressure hull varies according to the following sources:

Marine Technology Society (1):	18-24%
U.S. Navy Material Command (2):	17-23%
American Bureau of Shipping (3):	18.4-23.6%

While there seems to be no clear dividing line between a normal oxygen content and one which represents an excessive fire hazard, MTS and ABS both point out that 25 percent concentration produces noticeable differences in combustible materials. The Navy, on the other hand, clearly states that the submersible should immediately surface and ventilate the hull whenever oxygen exceeds 25 percent. Conversely, as oxygen concentration (partial pressure) decreases, the effects on occupants of the pressure hull are shown in Table 9.3.

According to the Standard Man's requirements, 0.9 cubic foot of oxygen per hour is consumed. The MTS and ABS suggest specifying oxygen storage duration on the basis of 1.0 cubic foot/hour of submergence. Because of the small internal volume of present submersibles, a supply of oxygen is virtually a universal requirement. All but two vehicles carry compressed, gaseous oxygen in flasks either inside or outside the pressure hull; *K-250* and *BEN FRANKLIN* are the two exceptions. The former carries no additional oxygen other than what is in the cabin air, and the latter carries liquid oxygen.

The location of the oxygen storage flask inside or outside the pressure hull is a trade-off decision on shallow-diving vehicles. External storage saves internal pressure hull volume, reduces total vehicle submerged weight and is somewhat easier to replenish. Additionally, ABS requires that if the filled oxygen storage system contains a volume of

TABLE 9.3 EFFECTS OF VARIOUS OXYGEN CONCENTRATIONS [FROM REF. (2)]

O <sub>2</sub> Concentration Partial Pressure Atmospheres	Effect
.21-0.18	Normal sea-level conditions
0.16-.12	Increased breathing rate, lack of coordination
0.14-.10	Easily tired; easily upset emotionally; possible loss of pain or injury; abnormal fatigue from exertion
0.10-.06	Lethargic; apathetic; confused thinking; physical collapse; possible unconsciousness, nausea and vomiting
0.06 or less	Convulsive movements, gasping, cessation of breathing

oxygen which exceeds 100 percent ( $\pm 10\%$ ) of the floodable volume of the pressure hull, then it must be stored in an independent subsystem. Locating the oxygen flask outboard of the pressure hull apparently satisfies this ABS requirement. Approximately one-third of all submersibles (for which such information is available) stores oxygen externally; correspondingly, all of these vehicles have operating depths of 2,000 feet or less. A number of Perry-built vehicles include this feature (Fig. 9.1).

Arguments against internal storage decrease with operating depth, for at some

point the oxygen flask must be made resistant to external pressure (as its internal pressure decreases with oxygen consumption), and the necessary strengthening adds weight. Other advantages of internal storage include the reduction of thru-hull penetrations and the security of having the entire system inside where it runs no risk of damage from external agents. In the final analysis, however, there appears to be no recommended location (inside vs. outside), for not MTS, ABS or the Navy addresses the subject as such. There is, however, a requirement in the 1974 ABS manual that the flask be lo-

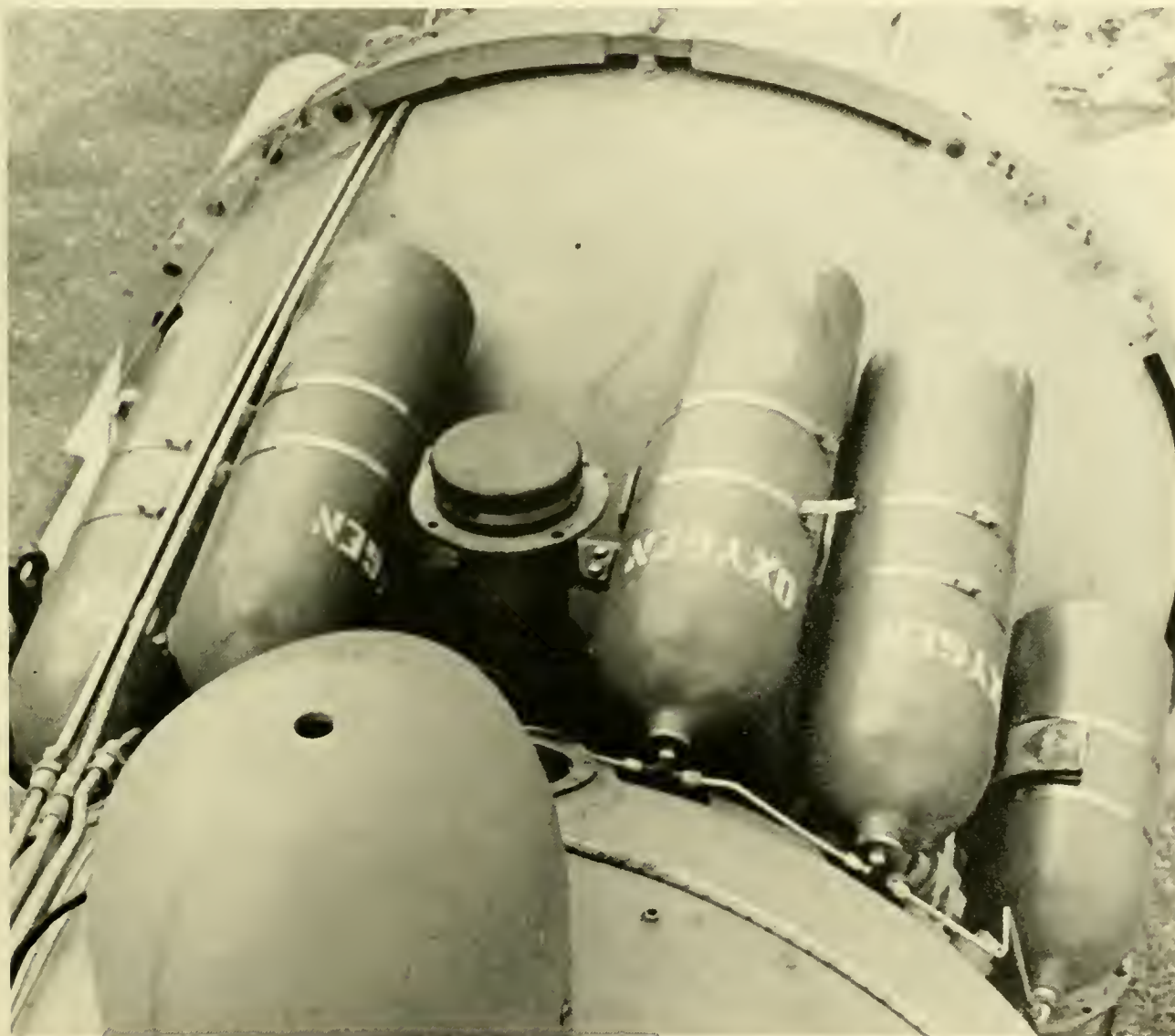

Fig. 9.1 Perry Submarine's *DEEP DIVER* carries four oxygen flasks topside between the diver lock-out chamber and helium sphere (NAVOCEANO)

cated at a distance from the hull or other critical pressure-resistant components such that the flask's implosion will not damage other items. (See Chap. 13 for "stand-off distance.")

There are ABS regulations on the storage flasks themselves: Storage pressure of 5,000 psi cannot be exceeded; the containers must comply with Department of Transportation (DOT) specifications (Part 78, Sub-part C; Sects. 78.36 to 78.68 inclusive) or any recognized standards; and on small cubmersibles (less than 60 meters LOA) the containers must be proof-tested and marked in accordance with DOT procedures approximately once every year, but not exceeding 18 months.

It is not the intent of this discussion to recommend what life support systems should be, but merely to relate what they are. The reader should be aware, however, that both the Navy and ABS quite explicitly state certain material requirements for: Piping, fittings and valves; operating pressures for control and monitoring devices; cleaning and storing; and testing and maintenance of the entire system.

Control of the flow of oxygen into the pressure hull is approached in three ways: The simplest is by periodically opening the flow valves; the most common is by continually bleeding the oxygen through a flow control valve and flow indicator; and the least common is by automatically admitting oxygen by

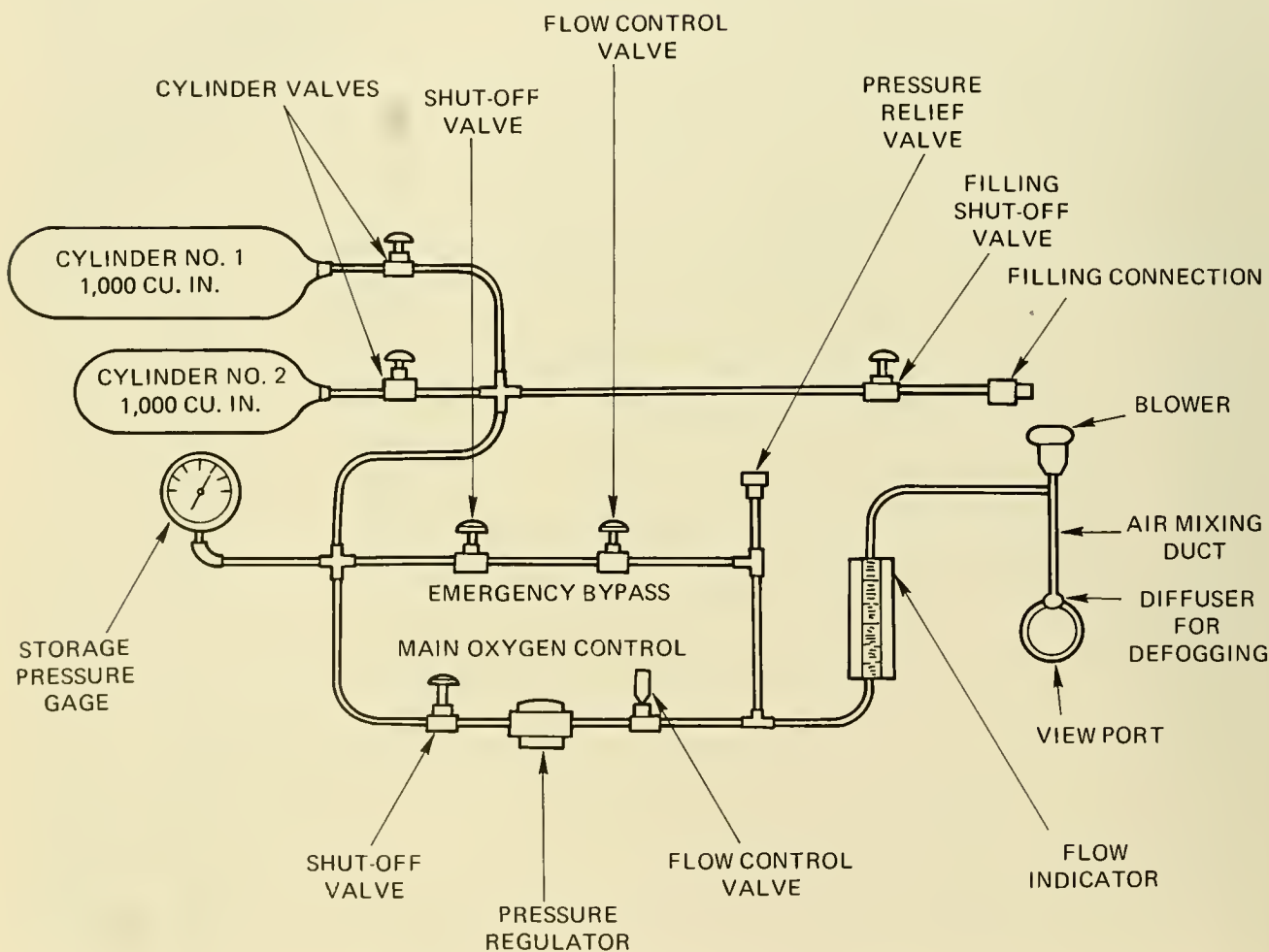

Fig. 9.2 Oxygen supply system schematic. [From Ref. (10)]

virtue of a mechanism which senses variations in cabin atmospheric pressure.

In a few vehicles the first approach is taken and, although not recommended by ABS or MTS, has worked satisfactorily with no reported accidents. The procedure is quite simple: A timer (quite frequently a kitchen alarm clock) is set to ring every half hour or so; when it does, the operator resets it, takes a reading of oxygen or cabin pressure and then, if necessary, opens the tank to admit a certain amount of oxygen.

In the second approach, the supply of oxygen is fed through a flow control valve, thence through a flow indicator and finally into the cabin. In this procedure the oxygen is continually bled into the cabin at a rate somewhere near 0.85 SCFH for each person.

The system still requires periodic monitoring to assure steady flow as internal tank pressure decreases or as cabin temperature varies. The system shown in Figure 9.2 is *DS-4000's*, and it includes a pressure regulator which maintains a downstream pressure of 80 psi ( $\pm 10$  psi) from a 3,000 psi tank as long as the storage pressure exceeds 80 psi. A further feature of this system is the air mixing duct, which mixes oxygen with cabin air and then blows the mixed air downward and across the viewport (Fig. 9.3). Whereas the steel pressure hull cools in accordance with ambient water temperature, fogging and drippage of condensed water on the viewport is common. With the modification shown, the forced air keeps the viewport dry. Eliot (4) cautions that the air flow should be

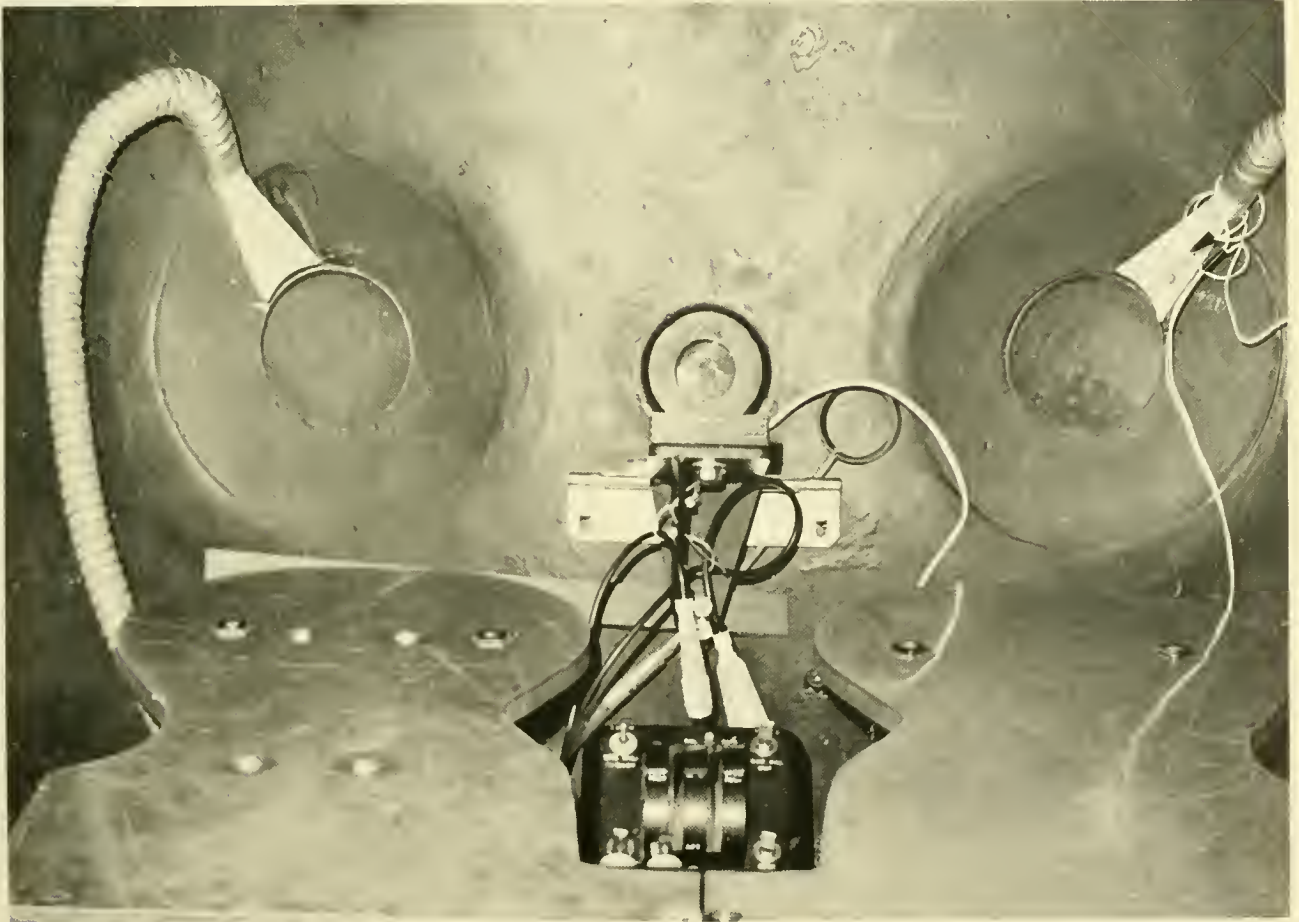

Fig 9.3 Ducts above *DEEPSTAR 2000's* viewports blow cabin air mixed with oxygen across the viewports to remove condensed moisture and prevent fogging. The small viewport between the larger two is for photography

directed downward, because when this device was initially used in *DS-4000* the flow was upward and the occupants emerged from a 6- or 8-hour dive with bloodshot eyes and dry nasal passages caused by the air blowing into their faces when at the viewport.

Automatic systems are not common on submersibles but can be found on the more sophisticated vehicles, such as *DEEP QUEST* and *DSRV*. Because life support control is so critical, the operator is still required periodically to monitor cabin oxygen. It only takes a little more time to check and regulate a flowmeter while performing the monitoring functions. If such checks are not routine, then a warning system is imperative, and, while this does add to the complexity and cost of the vehicle, it frees the operator for other tasks.

The quantity of oxygen carried varies from vehicle-to-vehicle. A comparison is shown in Table 9.4. The MTS recommends that the oxygen capacity of a system should be stated in cubic feet of oxygen at 70°F and 760 mm Hg, but this procedure is frequently not followed, hence, many of the values shown are approximate and were calculated from the barest of details.

From an efficiency point of view, Beving and Duddleston (5) point out that a typical cylindrical steel tank holds approximately 15 pounds of usable oxygen at 2,200 psi. The cylinder plus oxygen weighs about 150 pounds. With a usable weight ratio of 1-to-10, a considerable weight penalty is encountered if many tanks have to be carried. A more efficient solution, according to these authors, is to carry oxygen in liquid form. In a typical double-walled liquid oxygen tank, a pound of oxygen can be carried for each pound of tank with corresponding savings in volume. While Beving and Duddleston's efficiency figures for liquid vs. gaseous oxygen are impressive, the cost, complexity and logistic problems are unacceptable to most of today's commercial vehicle owners. Furthermore, it is not life support endurance which restricts present vehicles to short dives; rather, it is electrical endurance.

#### **Food and Water:**

There is no submersible now operating

that routinely remains submerged for more than 8 or 10 hours; consequently, food and water are generally provided in the form of sandwiches, fruit, candy and thermos jars of coffee, tea or whatever. Exceptions to this are *BEN FRANKLIN* (now inactive) and *NR-I*. The latter, in view of its size, mission endurance and nuclear electrical generating plant, presumably uses freeze-dried foods or prepackaged "TV" trays which are prepared and heated in a kitchen.

While such a casual approach to sustenance, at first glance, may seem alarming, it has produced no ill effects. Indeed, in most vehicles the support ship cook errs, if at all, in favor of quantity, for more often than not a portion of the lunch is returned uneaten. This procedure works well as long as the dive is routine. All have not been routine (see Chap. 15), however, and then emergency rations became a consideration; in this respect most are deficient.

In case retrieval is impossible or the submersible is lost from its support ship, emergency food and water could be a critical factor in survival. A wide variety of nutritious foods which can serve as emergency rations are available at sporting goods stores and have a shelf life of many months. Such fare is not necessarily a gourmet's delight, but survival, not comfort, is the order of business. The amount of emergency food and water required is difficult to ascertain, but little space is required for storage of these foods and a minimum of 72 hours of emergency supply does not appear unreasonable. Freeze-dried foods would be ideal, but in the small confines of a submersible their preparation is awkward and, without hot water, they are difficult to mix.

The recent *JOHNSON SEA LINK* and *PISCES III* incidents have increased the submersible community's awareness of life support, and a number of vehicles have increased their supply of oxygen and carbon dioxide removal compounds to extend support to 72 hours/occupant and longer. The National Oceanic and Atmospheric Administration (NOAA) requires at least 72 hours/occupant before it will allow its employees to dive in the vehicle. Oddly, no one has addressed the possibility of decreased human



**TABLE 9.4 MANNED SUBMERSIBLE  
LIFE SUPPORT CHARACTERISTICS AND INSTRUMENTATION**

Submersible	Crew <sup>1</sup>	Endurance	Oxygen	CO <sub>2</sub>	Monitoring De-			Trace	Temp.	Humidity
		(Man-Hrs)	Supply	Scrubbing	ices Aboard	Pressure <sup>3</sup>	Contaminant	Control		
	Total <sup>2</sup>	(SCF)	Compound	O <sub>2</sub>	CO <sub>2</sub>			Control	Control	Control
All Ocean Ind.	2	12	40	KO <sub>2</sub>	NP <sup>4</sup>	NP	NP	NP	NP	NP
ALUMINAUT	6	432	127	LiOH	•	•	•	NP	Heaters, Hull Insulation	NP
ALVIN	3	216	NA	LiOH	•	•	•	Activated Carbon	NP	NP
AQUARIUS I	3	108	140	LiOH	•	•	•	Activated Charcoal	NP	NP
ARCHIMEDE	3	108	NA <sup>5</sup>	Soda Lime	•	•	•	NP	NP	Silica Gel
ARGYRONETE	10	1920	163 <sup>6</sup>	NA	•	•	•	NP	Heaters/AC <sup>7</sup>	AC
ARIES I	4	108	140	LiOH	•	•	•	Activated Charcoal	NP	NP
ASHERAH	2	48	NA	Soda Sorb	•	•	NP	NP	NP	NP
AUGUSTE PICCARD	44	2112	NA	Soda Lime	NP	NP	NP	NP	NP	NP
BEAVER	4	360	250 <sup>6</sup>	Baralyme	•	•	•	NP	NP	NP
BEN FRANKLIN	6	6048	922lb	LiOH	•	•	•	Activated Charcoal	NP	Silica Gel
DEEP DIVER	4	32	356 <sup>6</sup>	Baralyme	•	•	•	NP	NP	NP
DEEP JEEP	2	104	NA	Soda Lime	NA	NA	NA	NP	NP	NP
DEEP QUEST	4	204	200	LiOH	•	•	•	Activated Charcoal	Heaters	AC
DS-2000	3	144	169	LiOH	•	•	•	NP	NP	NP
DS-4000	3	144	169	LiOH	•	•	•	NP	NP	NP
DS-20000	3	144	169	LiOH	•	•	•	NP	NP	NP
DSRV-1 & 2	27	204	NA	LiOH	•	•	•	NA	AC	AC
DEEP VIEW	2	38	36	LiOH	•	•	•	NP	Ice Tray	Silica Gel
DOSTAL & HAIR	2	80	80	Molecular Sieve	NA	NA	NA	NA	NP	NP
DOWB	3	195	160	LiOH	•	•	•	NP	NP	Desiccant
FNRS-2	2	100	NA	Soda Lime	NA	NA	•	NP	NP	Silica Gel
GRIFFON	3	100	NA	Soda Lime	•	•	NA	NA	NA	NA
GUPPY	2	72	NA	Baralyme	•	•	•	NP	NA	NA
HAKUYO	4	144	NA	Baralyme	•	•	NA	Activated Charcoal	NP	Silica Gel
HIKINO	2	48	36	LiOH	•	•	•	NP	NP	Silica Gel
JOHNSON SEA LINK	4	72	660 <sup>6</sup>	Baralyme	•	•	•	NA	AC	AC
JIM	1	16	NA	Soda Lime	•	NP	•	NP	NP	NP
K-250	1	6	NP	NP	NP	NP	NP	NP	NP	NP
KUMUKAHI	2	32	NA	Soda Lime	•	•	•	NP	NP	Silica Gel
MAKAKAI	2	72	NA	Baralyme	•	•	NA	NP	Ice Tray	Silica Gel
MERMAID I	2	120	167	NA	•	•	NP	NP	NP	NP
NEKTON A, B, C	2	48	75	Baralyme	•	NA	•	NP	NP	NP
NEMO	2	64	100	Baralyme	•	•	•	NP	Ice Tray	Silica Gel
NEREID 330	3	96	NA	NA	•	•	•	NP	NP	NP
OPSUB	2	50	NA	Baralyme	•	•	•	NP	NP	NP
PC-3A1 & 2	2	20	70	Baralyme	NP	NP	•	NP	NP	NP

<sup>1</sup>Maximum Normal Complement

<sup>2</sup>Normal and Emergency Combined

<sup>3</sup>Cabin Pressure

<sup>4</sup>NP: No Provisions Aboard

<sup>5</sup>NA: Information Not Available

<sup>6</sup>Hydrogen and Compressed Air Also Available

<sup>7</sup>AC: Air Contitioner

**TABLE 9.4 MANNED SUBMERSIBLE  
LIFE SUPPORT CHARACTERISTICS AND INSTRUMENTATION (Cont.)**

Submersible	Crew <sup>1</sup>	Endurance	Oxygen	CO <sub>2</sub>	Monitoring De-			Trace	Temp.	Humidity
		(Man-Hrs) Total <sup>2</sup>	Supply (SCF)	Scrubbing Compound	vices Aboard O <sub>2</sub> CO <sub>2</sub> Pressure <sup>3</sup>	Contaminant Control	Control			
PC-38	2	20	70	Baralyme	NP	NP	•	NP	NP	NP
PC5C	3	180	100	Baralyme	NP	NP	•	NP	NP	NP
PC-8	2	48	288	LiOH	•	•	•	NP	NP	NP
PC-14	2	48	66	LiOH	•	•	•	NP	NP	NP
PISCES I	2	200	50	LiOH	•	•	•	NP	NP	Desiccant
PISCES II & III	3	200	50	LiOH	•	•	•	NP	NP	NA
PISCES IV & V	3	216	NA	LiOH	•	•	•	NP	NP	Desiccant
PS-2	2	48	288	LiOH	•	•	•	NP	NP	NP
SDL-1	6	204	870	Soda Sorb	•	•	NP	NP	NP	NP
SEA CLIFF/TURTLE	3	105	123	LiOH	•	•	•	Activated Charcoal	NP	NP
SEA OTTER	3	200	192	LiOH	•	•	•	NP	NP	NP
SEA-RAY	2	24	NA	Soda Lime	NA	•	NA	NA	NA	Silica Gel
SHELF DIVER	4	172	338	LiOH	NP	NP	•	NP	NP	NP
SNOOPER	2	24	NA	Baralyme	NA	NA	NA	NA	NA	NA
SP-350	2	96	40	Baralyme	•	•	NP	NP	NP	NP
SP-500	1	12	NA	Baralyme	NP	•	•	NP	NP	NP
SP-3000	3	144	NA	IR 8	NP	•	•	NP	NP	CoCl <sub>2</sub>
SPORTSMAN 300/600	2	16	15	Baralyme	NP	NP	NP	NP	NP	NP
STAR I	1	18	18	Soda Sorb	•	NA	NA	NP	NP	NP
STAR II	2	48	NA	Soda Sorb	•	•	NP	NP	NP	NP
STAR III	2	120	110	Soda Sorb	•	•	NP	NP	NP	NP
SUBMANAUT (HELLE)	2	24	60	NA	NP	NP	NP	NP	NP	Desiccant
SUBMANAUT	6	300	20	Soda Lime	NP	NP	NP	NP	NP	NP
SUBMARAY	2	32	50	Baralyme	NP	NP	•	NP	NP	NP
SURV	2	100	80	Soda Lime	•	•	•	NP	NP	NP
SURVEY SUB I	4	240	240	LiOH	NA	NA	NA	NA	NA	NA
TOURS 64/66	2	60	NA	Soda Lime	•	•	•	NP	NP	NP
TRIESTE II	3	72	NA	LiOH	•	•	•	Activated Charcoal	NP	NP
VDL-L1	4	192	288	LiOH	•	•	•	NA	NP	NP
YOMIURI	6	492	NA	LiOH	NA	NA	NA	NA	NA	NA

<sup>1</sup>Maximum Normal Complement

<sup>2</sup>Normal and Emergency Combined

<sup>3</sup>Cabin Pressure

<sup>4</sup>NP: No Provisions Aboard

<sup>5</sup>NA: Information Not Available

<sup>6</sup>Hydrogen and Compressed Air Also Available

<sup>7</sup>AC: Air Conditioner

capabilities or even death because of the lack of food or water. Humans' existence without food or water varies considerably, and there are incredible tales of individuals existing under extremely trying conditions for long

periods of time. But in a submersible more than mere existence may be required of the occupants; they may have to perform some function to bring rescuers to their aid. In a situation where the hull temperature is high,

water will become the most critical factor; where the temperature is low, food will become critical. As mentioned, storage of food is easy and requires little space; water, on the other hand, requires much more volume and can become nonpotable. Whereas both food and water are required, a compromise solution might be found in one of the diet supplements (Metrecal, Nutriment, etc.) which provide both food and water. Such liquid supplements require little space, they are nutritious and have a long shelf life. Regardless of the liquid and solid sustenance supplied, it appears rather paradoxical to supply a 3- or 5-day supply of oxygen and carbon dioxide remover when the occupants might well perish from lack of food and water before these critical components run out.

### Removal

Certain products of human and non-human origin must be removed from or stored within the cabin environment. These are: Carbon dioxide, trace contaminants and solid and liquid human waste products. The removal of the first two products is necessary for survival. Other metabolic wastes are held in sealed or chemical storage. Although gaseous by-products may become noxious, if not properly stored, they are not necessarily toxic.

#### Carbon Dioxide:

The major source of carbon dioxide in a submersible is human respiration. According to reference (2), an average consumption of 1.0 SCFH of oxygen per person will generate an average of 0.80 to 0.85 SCFH of carbon dioxide (depending on dietary considerations), an equivalent of 0.1 pound/man-hour. To derive the rate of carbon dioxide buildup, the Respiratory Quotient (RQ) is required, and it is equal to the volume of carbon dioxide produced for each volume of oxygen consumed, or:

$$RQ = \frac{\text{Volume of CO}_2 \text{ Produced}}{\text{Volume of O}_2 \text{ Consumed}} = \frac{0.85}{1} = 0.85$$

In a closed submersible, carbon dioxide will increase in accordance with:

$$\%CO_2 = 0.03 + \frac{(RQ) \times O_2 \text{ (Consumption rate)} \times T}{V/N}$$

where: T = Time in hours  
 V/N = Floodable Volume per person  
 RQ = Respiratory Quotient  
 0.03 = % of CO<sub>2</sub> in "Clean" Air

Using this formula and the "standard man" in the 3-man submersible **DOWB** (140 ft<sup>3</sup> floodable volume) the following buildup could be expected on an 8-hour dive where there is no carbon dioxide removal system:

$$\%CO_2 = 0.03 + \frac{(0.85)(1.0)(8)}{3}$$

$$\%CO_2 = 0.18$$

The U.S. Navy recommends that 0.014 atmosphere of partial pressure (1.5%) be the exposure limit of carbon dioxide, while 0.02 atmosphere (2%) indicates a dire emergency. ABS recommends a maximum of one percent for long term exposure and MTS agrees with this maximum, but notes that a maximum carbon dioxide level of 0.5 percent should be the design goal for 60- to 90-day missions.

The effects of various carbon dioxide levels on humans as a function of time is shown in Figure 9.4. The bar graph to the right of this figure is for exposure of 40 days and shows that concentrations of carbon dioxide in air of less than 0.5 ATA (atmospheres) (Zone A) cause no biochemical or other effects, concentrations between 0.5 and 3.0 percent (Zone B) cause adaptive biochemical changes, which may be considered a mild physiological strain, and concentrations above 3.0 percent (Zone C) cause pathological changes in basic physiological functions. For normal operations, the Navy recommends that carbon dioxide removal rates should be provided that result in carbon dioxide partial pressures corresponding to Zones I and II for short-term exposures, and to Zones A and B for long-term exposures.

It is obvious, therefore, that a means should be available to reduce excess carbon dioxide or control it at a level where it will not affect the occupant's judgement or physical abilities on a routine dive—and especially if the vehicle may be unable to surface or open the hatch.

In order of decreasing usage, four chemical substances are used to remove carbon diox-

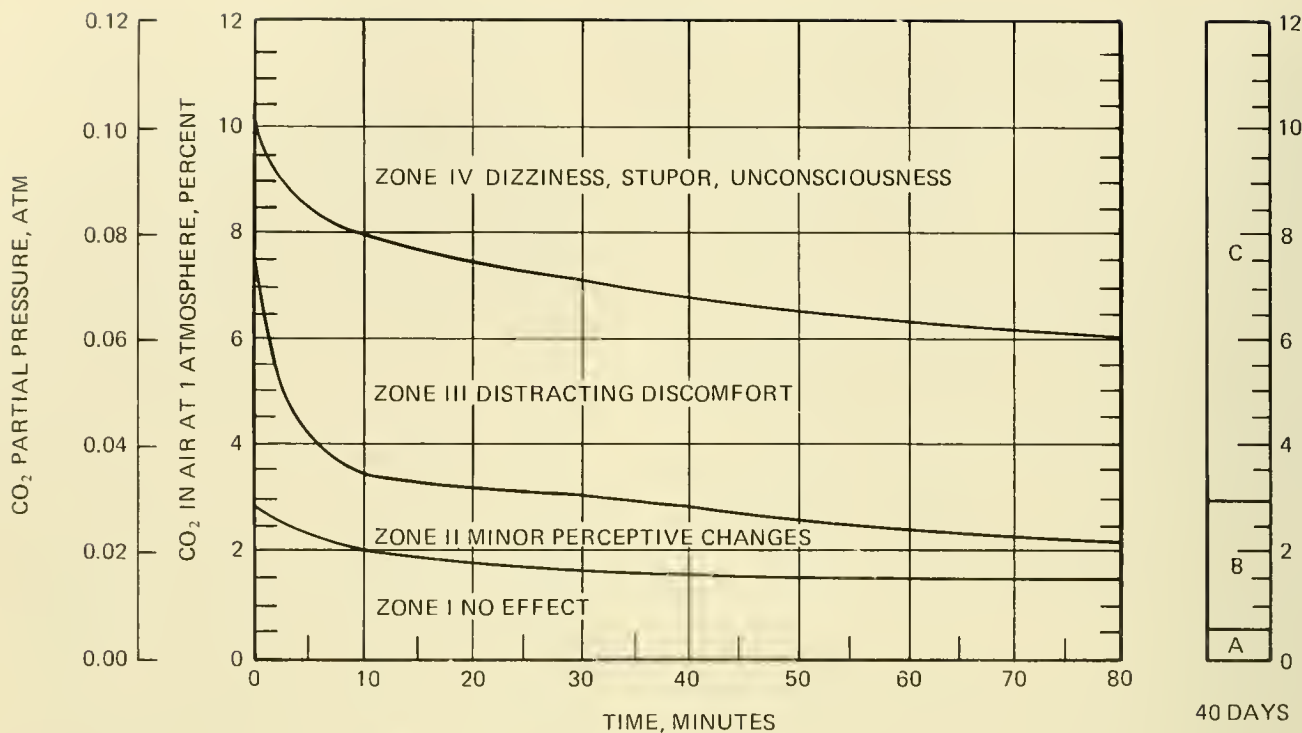

Fig. 9.4 Relation of physiological effects to carbon dioxide concentration and exposure period. [From Ref. (2)]

ide within submersibles: Lithium hydroxide (LiOH), a strong alkali; Baralyme (a weak alkali); Soda Sorb (similar to Baralyme, but contains small amounts of sodium hydroxide and potassium hydroxide as an "activator"); Soda lime (a low moisture Soda Sorb) and potassium superoxide (KO<sub>2</sub>). The last of these compounds, KO<sub>2</sub>, performs the dual role of supplying oxygen as well as removing carbon dioxide.

The carbon dioxide "scrubber" system is quite simple: A blower assembly forces cabin air through one of the above compounds which, in turn, removes carbon dioxide from the air as it passes through. There is no conformity vehicle-to-vehicle on the type of fan, power of the fan motor, or volume or configuration of the chemical bed. In the *All Ocean Industries* vehicle an automobile vacuum cleaner is packed with KO<sub>2</sub> and the vacuum cleaner motor operates directly off the 12-volt battery. In *DS-4000* a 1/50-hp electric motor works directly from a 120-volt supply to turn a drum type impeller which forces air through a cannister containing LiOH. In *BEN FRANKLIN*, 13 thin rectangular

panels containing LiOH were hung throughout the vehicle and natural convection currents in the cabin served to pass air through the panels.

As far as certification or classification is concerned, the system used to force cabin air through the absorbent chemicals is left more or less up to the individual. The ABS states that the system should be designed with a 20 percent safety factor (*i.e.*, 0.10 lb CO<sub>2</sub> per man-hr × 120% = 0.12 lb per man-hr minimum). The MTS states that it is preferable to use an AC induction motor rather than a brush type DC motor to eliminate arcing from the brush type motors.

Probably the best and undoubtedly the most recent summation of carbon dioxide removal chemicals and their characteristics is presented in the report of the *JOHNSON SEA LINK* incident (6) in which two occupants of the lock-out cylinder perished of respiratory acidosis as a consequence of carbon dioxide poisoning. The following summation was written by one of the investigating panel members, W. M. Nicholson, and is

taken from Appendix 16 of reference (6); it is only changed insofar as references and table numbers are concerned to make them compatible with the numbering herein:

*“Review of life support systems indicates wide variance in certification standards with reference to the time requirements.*

*An extensive survey (G. E., NRL, Westinghouse, Navy Sup-Dive, etc.) also indicates that basic performance data are not available for all conditions—particularly conditions of low temperature and high pressure. Test programs have been proposed by NRL to accomplish this work but the programs have never been funded. Basic characteristics of the commonly used materials are shown in Table 9.5 (taken from ref. 6). It can be inferred from ref. (8) that LiOH performance would have been operating in a near optimum condition at the low temperatures encountered, and that it has a relatively flat performance curve in terms of temperature variation. It should be noted, however, that the*

*actual tests (8) did not use gas input temperatures below 77°F.*

*It is significant that the most detailed investigations have been performed in connection with development of closed circuit breathing rigs. These investigations have universally noted sensitivity of the removal process to temperature, to moisture, to the precision of packing the cannisters and to the configuration of the cannisters. Effectiveness of removal is enhanced in the closed circuit design by the diver breathing warm air directly into the cannister, a process which is not used in submersibles. They have also noted marked deterioration, particularly in low temperature performance, which appears to be the result of water condensing in the cannister, as well as possible temperature variance in the rate of reaction.*

*Serious deterioration in performance was noted for baralyme stored in standard iced containers. These conditioners are intended for use in hospitals where storage conditions are controlled and 2-year life is expected.*

TABLE 9.5 CHARACTERISTICS OF THREE CARBON DIOXIDE ABSORBENTS [FROM REF. (6)]

Characteristic	Absorbent		
	Baralyme	Lithium hydroxide	Soda Sorb
Absorbent density, lb/ft <sup>3</sup>	65.4	28.0	55.4
Theoretical CO <sub>2</sub> absorption, lb CO <sub>2</sub> /lb	0.39	0.92	0.49
Theor. water generated, lb/lb CO <sub>2</sub>	0.41	0.41	0.41
Theor. heat of absorption, 8tu/lb CO <sub>2</sub>	670 <sup>b</sup>	875 <sup>b</sup>	670 <sup>a</sup>
Useful CO <sub>2</sub> absorption, lb CO <sub>2</sub> /lb (based on 50 percent efficiency)	0.195	0.46	0.245
Absorbent weight, lb per diver hr (0.71 lb CO <sub>2</sub> )	3.65	1.55	2.90
Absorbent volume, ft <sup>3</sup> per diver hour	0.0558	0.0552	0.0533
Relative cost, \$/diver hr (1968)	\$1.75	\$6.20	\$0.75

<sup>a</sup>Based on generating gaseous H<sub>2</sub>O

<sup>b</sup>Based on calcium hydroxide reaction only

*This packaging, while convenient in size, is not suited to the severe handling and storage in the marine environment. Five-gallon (40 lbs) plastic sealed containers are available and can be expected to give better quality assurance.*

*A check of the National Oceanographic Data Center records on the 1-degree square in which this incident took place produced the curve provided on Figure 9.5. It will be noted that the lowest temperature to be expected in this area is about 59°F. At this temperature, using Navy Diving Operations Manual performance figures, the load (24 lbs) carried in the diving chamber should have lasted for 21 hours. The forward chamber (16 lbs) should have lasted 20 hours, assuming 70°F in that sphere and good baralyme. The variation in actual performance from that predicted here is not readily explainable but could have been the result of defective baralyme packaging, improper packing of the cannister, or spreading by the crew when the cannisters were emptied,—probably a combination of these.*

*I feel we (the expert panel) should consider the following recommendations for inclusion in the final report relating to CO<sub>2</sub> removal systems:*

*a. Submersibles should carry at least a 48-hour supply of absorbent (this is consistent with ref. 1).*

*b. Lithium hydroxide is to be preferred wherever low temperatures are encountered.*

*c. Only absorbents which are hermetically sealed should be carried.*

*d. Such seals must be periodically checked.*

*e. Uniform chemical packing is vital and steps should be taken to insure this for both pre-packaged cannisters and those re-loaded on scene.*

*f. A program to develop accurate performance parameters for absorbents under the full range of anticipated pressures and temperatures should be undertaken and the results*

*made available to the entire diving community."*

Enclosure 2 to Nicholson's summation and recommendations discussed the effects of temperature, humidity and absorbent bed-configuration on carbon dioxide removal. The following is extracted from that enclosure:

*"The rate at which carbon dioxide is absorbed in absorbents is influenced by temperature, and is considerably lower at 40°F than at 70°F. In some scrubbers sized for adequate performance at 70°F, absorbing capacity at 40°F may be as little as 1/3 that at 70°F. This effect is strongly dependent upon the cannister design and the rate of carbon dioxide absorption, being most evident in absorbers working at peak flow rates, and least evident in oversized scrubbers and those used intermittently.*

*It appears highly desirable to provide external insulation and heating of scrubbers for use in cold water as a means of minimizing size and assuring that the design absorbent capacity can be obtained. This is also advisable as a means of avoiding moisture condensation. A possible alternative is to design for about three times the absorbent capacity needed at 70°F.*

*The efficiency of absorbents is influenced by relative humidity. The absorbing capacity quoted for Baralyme and Soda Lime absorbents is obtained only when relative humidity is above 70 percent. Lower humidity levels result in less absorbent capacity. Breathing-gas humidity would usually be well above 70 percent unless the scrubber is preceded by a dehumidifier.*

*Under conditions of high gas humidity and low scrubber surface temperature it is possible to condense water on the cannister walls or in the absorbent. This is undesirable because wet absorbent is inactive and impervious to air flow, reducing absorptive capacity and increasing pressure drop through the cannister. Scrubbers for*

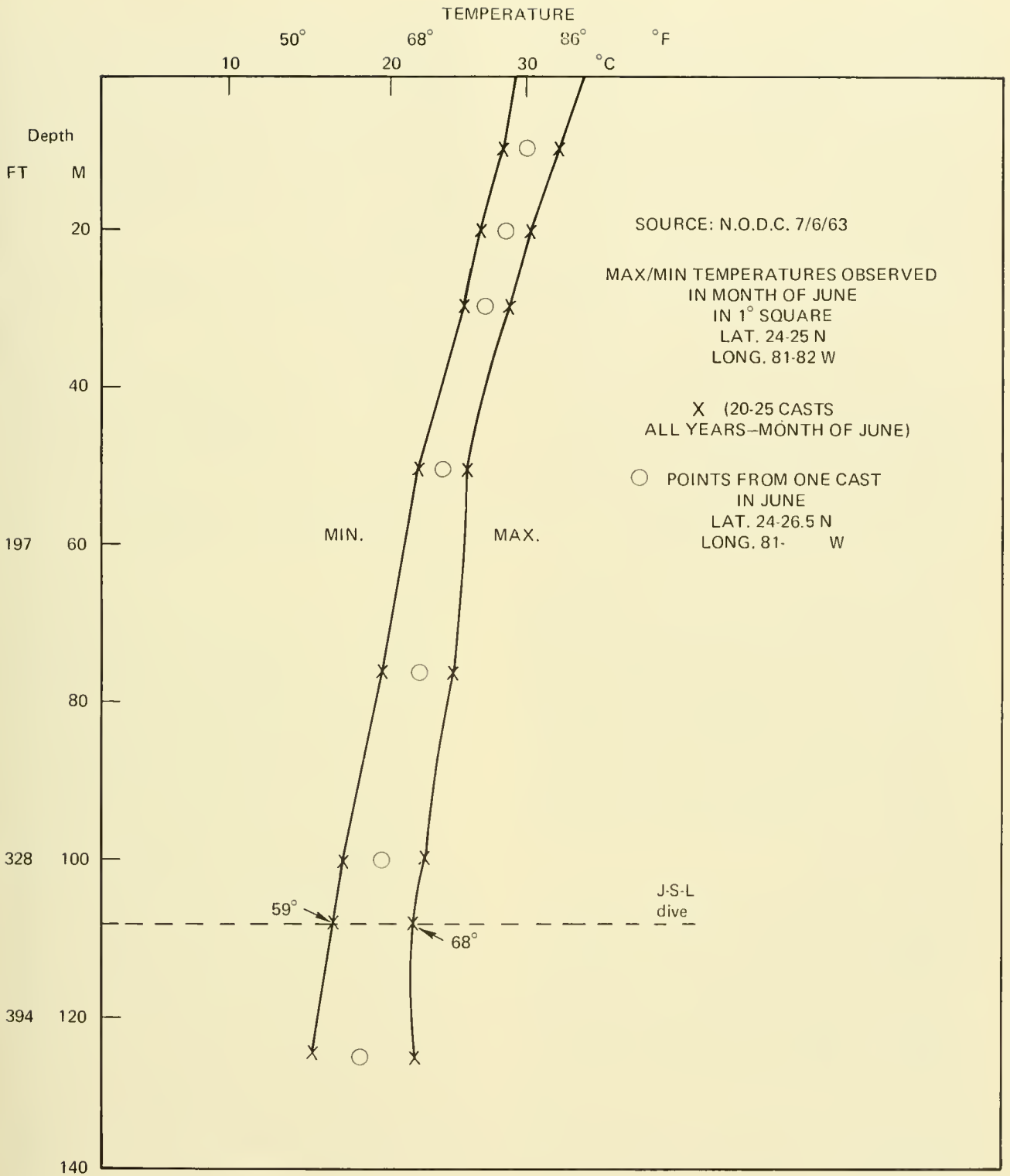

Fig. 9.5 June temperatures – Key West area. [From Ref. (6)]

*use in cold water can be designed to minimize moisture condensation by incorporating thermal insulation or by heating of the canister.*

*A variety of absorbent-bed configurations are in use, and none seem to have advantages that make them universally applicable. The principal design requirements are to provide an adequate amount of absorbent, very uniform distribution of gas flow through the absorbent bed, and sufficient time for the absorption reactions to occur.*

*The total weight of the absorbent can be selected on the basis of the total weight of carbon dioxide to be absorbed. The volume of a tightly packed absorbent bed will then depend upon the absorbent density, and the residence time will be the same for any configuration of this volume.*

*The pressure drop through an absorbent bed will depend upon the relation of flow cross section and bed depth for a fixed bed volume. A large cross section and small depth will result in low pressure drop. However, flow distribution over the cross section depends upon uniformity of pressure drop, and may be difficult to control if the bed is too thin. This difficulty can be minimized by using a perforated plate at the inlet of the bed to provide controlled pressure drop and flow distribution.*

*If bed volume is selected on the basis of absorbent weight, then the residence time of gas in the bed will be proportional to the rate of ventilation through the absorber. As a general rule the volume flow rate through the scrubber should be the same at all depths, matching respiratory volume characteristics."*

Reference (6) did not discuss potassium superoxide as a carbon dioxide absorbent, but Presti *et al.* (9) provided the results of a design, development and testing program of commercially available  $\text{KO}_2$  for submersible life support. The *All Ocean Industries* vehicle is the only one known to use  $\text{KO}_2$  al-

though its application was tested and found successful by the General Dynamics investigators for *STAR III*. Mentioned earlier was the ability of  $\text{KO}_2$  to both supply oxygen and absorb carbon dioxide. In brief, when cabin air passes through the  $\text{KO}_2$  bed the moisture in the air reacts with the  $\text{KO}_2$  to produce oxygen and potassium hydroxide (KOH). The KOH, a strong alkali, then absorbs carbon dioxide.

According to the authors, a  $\text{KO}_2$  system offers the following advantages:

- It weighs less and occupies a smaller volume
- It costs less to operate
- Stored properly, it has an indefinite shelf life
- It removes water from the atmosphere
- Its color change (canary-to-white) can be used as a depletion indicator
- It will remove odors and trace contaminants and kill micro-organisms.

On the other hand, Presti and his co-investigators admit to several disadvantages of  $\text{KO}_2$ :

- An initial over production of oxygen can occur
- Caking or "mushing" and subsequent plugging of the  $\text{KO}_2$  bed can take place
- $\text{KO}_2$  emits an irritating dust
- It is a strong oxidizer and therefore must be handled and used with care
- It reacts very readily with water to produce oxygen and heat; with sufficient heat, combustible materials can ignite.

The authors, however, describe design and handling methods to overcome the disadvantages and offer test results to show  $\text{KO}_2$ 's practical application in small submersibles.

Another system, using a molecular sieve solid absorbent which can be regenerated, is planned for use in a submersible under construction by Messrs. P. Dostal and J. Hair of Alvin, Texas. In a personal communication Mr. Dostal sketched the system shown in Figure 9.6 and cautioned that it is only in the design stage and, because of its complexity, its use is speculative. The philosophy leading to this system and its operation is described by Mr. Dostal as follows:

*"Originally, we had planned to use LiOH in the scrubber, which was caus-*



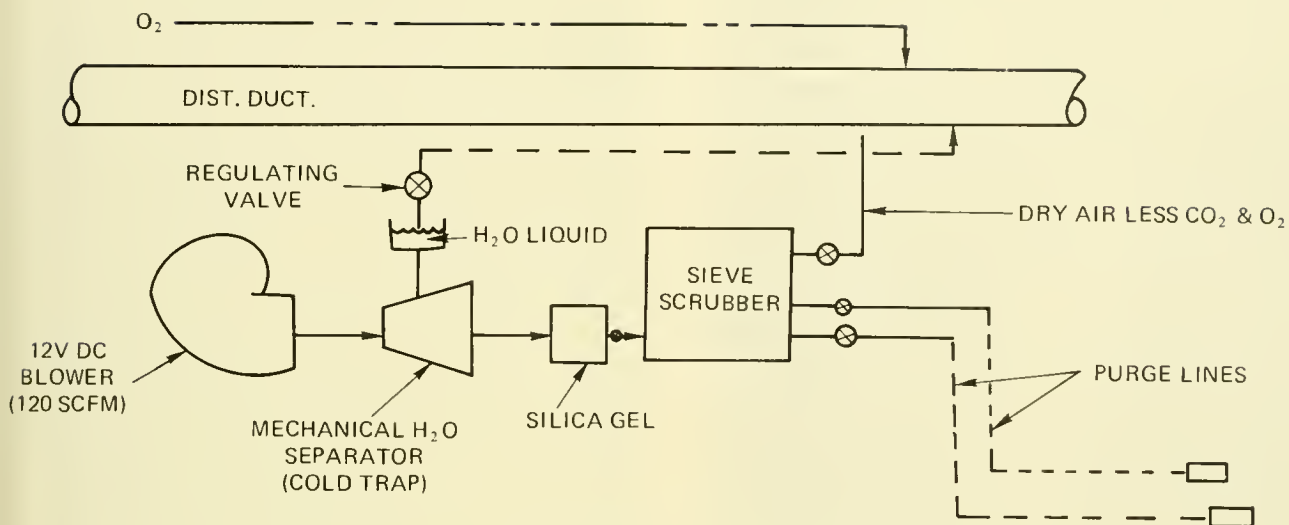

Fig. 9.6 Schematic of the molecular sieve carbon dioxide scrubbing system for a manned submersible. (Mr. P. Dostal, Alvin, Texas)

tic, hard to store, cost \$5.00 a pound and had to be thrown away when expired. We then decided to try a product of Linde Division of Union Carbide called molecular sieves. This substance was originally manufactured for use in water vapor removal for industrial gas processes, but using the right size (5 angstrom pores) it can remove CO from an airstream. It does this by absorption, which is not a chemical process; therefore, you can purge the system with a dry gas at about 800°F and use it over and over again. To use it as a CO<sub>2</sub> scrubber, the entering airstream must be free of any water vapor. This is because the water molecule is a much more polar molecule than CO<sub>2</sub>, and the sieve has a preference for polar molecules. We are therefore designing a water separator (cold trap) to be used upstream of the scrubber; this mechanism will condense out the water vapor which will be collected and redistributed downstream of the scrubber. Since the air coming out of the scrubber will be 100 percent dry, by adjusting the amount of water redistributed we can control our humidity. We will also

have a small container of Silica Gel upstream to assure that the air will be dry before entering the scrubber. The whole system should be a fairly small and light-weight package. We will leave the system in the submarine, and have our purge lines running to fittings in the hull. Our purge system, of course, will be external, and the cost of the purge gas (N<sub>2</sub>) will be the only expense of our system."

The final selection of a carbon dioxide scrubbing system and compounds should be made only after very careful deliberation. Not only should the approach take into consideration the more obvious factors of cost, scrubbing efficiency, packaging, handling, etc., which can be gained from the foregoing discussion, but, to the extent possible, the less obvious factors which may be external to the vehicle. According to reference (6), it was known that the effectiveness of Baralyme (the scrubbing compound used in *JOHNSON SEA LINK*) decreased markedly as temperature decreased. However, the operators anticipated that all dives would be in warm waters (65°F or higher), but the data presented in Figure 9.5 show that the seawater

temperature at the dive location varies widely about the 65°F value. The last ambient temperature measurement taken by the vehicle's occupants (38 minutes prior to entanglement) showed 51.8°F, and the communications log showed 45°F temperature within the aluminum lock-out cylinder some 8 hours later. At this unexpected temperature the Baralyme's effectiveness was severely curtailed. Indeed, no indication of such low water temperatures was indicated even from historical data. Another consideration became evident in the characteristics of the different pressure hull materials used for the aluminum lock-out chamber and the forward acrylic sphere. Unlike aluminum, acrylic plastic has a low heat transfer coefficient and the operation of equipment therein maintained a temperature of 70°F at which the Baralyme functioned adequately. At the very least, the **JOHNSON SEA LINK** tragedy demonstrated how paltry our knowledge of the ocean is. While there is much we can predict about it generally, there are few areas that we can predict specifically, and it is within this broad host of unknowns that the submersible dives.

#### Trace Contaminants:

The broad spectrum of trace contaminants generally includes all atmospheric contaminants, other than carbon dioxide, produced by the human occupants, the electronic or mechanical machinery, paints and solvents and, in some vehicles, batteries within the pressure hull. Referring back to Table 9.2, it is obvious that a wide variety of such contaminants can evolve. The critical factor in this category is time of exposure, and most vehicles do not have a submerged endurance which allows these contaminants to reach toxic levels. This is not to imply that the evolution of trace contaminants may be ignored, but their detection and removal have been a secondary consideration by most designers because of the short diving time. But, as the **JOHNSON SEA LINK** and the **PISCES III** incidents demonstrated, life support for routine diving is not a difficult proposition; it is the non-routine dive that introduces the moment of truth.

The ABS has divided trace contaminants into "unavoidable" and "avoidable"—the former being those produced by the human body in its normal functions (*e.g.*, H<sub>2</sub>, CO<sub>2</sub>, NH<sub>3</sub>, H<sub>2</sub>S, SO<sub>2</sub>, CH<sub>4</sub> and forms of aldehydes and alcohols) and the latter being those produced by equipment for cooking. Under avoidable contaminants they caution that all instruments should be carefully selected to avoid contaminant production. Mercury thermometers should be avoided and non-reactive protecting and insulating electronic materials should be used.

Both the ABS and the U.S. Navy require that a sample of cabin air, obtained under simulated closed hatch operations, be analyzed by chromatography. Such analyses must be performed for initial certification/classification, and thereafter when major overhauls are conducted. The Navy further requires these analyses whenever the interior is repainted or cleaned with solvents that contain hydrocarbons or other toxicants.

Removal of trace contaminants can be performed by absorption, adsorption or oxidation, and the following compounds may be used either actively (by incorporating them in the scrubber system) or passively (by placing them in panels or devices into which cabin air can circulate under natural convection currents or circulating fans): Activated charcoals, LiOH, soda lime or other alkaline earths and Purafil (activated alumina impregnated with potassium permanganate). In the few submersibles that take specific measures to remove trace contaminants, activated charcoal or carbon is preferred. Iannuzzi (10), in discussing the role of activated charcoal in odor removal, relates that the occupants of **DS-4000** reported no discomforting effects from the cabin aroma whether charcoal was used or not used; consequently, its addition to the LiOH cannister was discontinued.

In those submersibles where the batteries are stored in the pressure hull, the role of Hydrocaps in recombining the hydrogen generated with oxygen into water was discussed in Chapter 7. It will suffice to mention that a number of submersibles with in-hull battery arrangements also include hydrogen detectors to monitor cabin air.

### Human Wastes:

For long duration missions the nature and source of human wastes which must be considered are shown in Table 9.6. The *Bioastronautics Data Book* (11) provides quantitative information on all of these products. Because of the short dive duration, today's submersibles generally only consider urine, feces and vomitus for their waste storage/control system. No known submersible design incorporates a means of ejecting such wastes into the sea; consequently, all approaches eventually lead to storing them until the dive is terminated. The exception, as noted previously, is the *BEN FRANKLIN's* system of waste tanks for long duration storage.

The solution to storage of human wastes is inordinately simple: A plastic, sealable bag takes care of vomitus, and a jar or chemical toilet takes care of urine and feces. Figure 9.7 shows *DS-2000's* approach to urine storage and it typifies the approach in most vehicles—it is a polyethylene container made for the light aircraft industry and has a liquid capacity of one quart.

A temporary solution to urine and feces storage is to fast for some period before the dive commences and to use the support ship facilities just prior to embarking on the submersible. While the topic does have its humorous aspects, there is nothing humorous



Fig. 9.7 *DEEPSTAR 2000's* human element range extender (HERE).

as far as one's fellow occupants are concerned. In view of the normal discomfort within small submersibles, consideration in this vein is not only courteous, but in the final analysis, the by-product gasses might

TABLE 9.6 HUMAN WASTE PRODUCTS [FROM REF. (1)]

Waste	Source	Examples
Solid	Metabolic	Feces
	Debris	Hair, Nail Clippings, Toilet Paper, Metal Cans, Bottles, Paper, Plastic Packages
	Other	Waste Food, Vomitus
Liquid	Metabolic	Urine, Respiration, Perspiration
	Other	Wash Water, Waste Foods (Coffee, Tea, Milk, etc.), Chemicals
Gaseous	Metabolic	Flatus, Ammonia, CO <sub>2</sub> , CO
	Other	Material Outgassing, Bacterial Metabolism

very well nauseate the occupants and be quite detrimental to the mission. Dr. R. C. Bornmann, Captain, USN, (personal communication) states that for a short duration exposure and with human occupants in good health, there is no danger to their health from the gasses evolved, other than their noxious effects.

### Temperature-Humidity Control

Aspects of the cabin environment that have a direct effect on both occupants and electronic equipment are temperature and humidity. Only a handful of submersibles provide control of these variables and the results, as we saw from the *JOHNSON SEA LINK*, can be fatal in the extreme. For the most part, however, high and low temperatures and high humidity are inconveniences that are tolerated until the dive is finished. But in some instances, the lack of control can seriously alter the mission. For example, it was planned to conduct periodic 24-hour bottom excursions during *BEN FRANKLIN*'s 30-day Gulf Stream Drift, but none of these excursions lasted more than 9 hours because the temperature in the cabin dropped into the low 50's (°F). While this temperature was tolerable, the correspondingly high humidity (82%) produced a bone-chilling cold that left little more on the occupant's mind than to get warm (Fig. 9.8). Concentration on anything else was all but impossible. The situation was corrected by ascending into shallower, warmer waters.

On the opposite end are the effects of high temperature and high humidity. During tropical operations with *DS-4000*, Merrifield (12) reports cabin temperatures of 100°F and 100 percent humidity when operating at less than 600 feet—with the result that the occupants' effectiveness was seriously impaired.

The enervating effects of high temperature and humidity can begin long before the vehicle submerges. In the tropics and subtropics between-dive maintenance aboard ship requires the support personnel to work in the vehicle where conditions can become almost unbearable unless some form of air-conditioning is provided. Many support ships are equipped to blow cool air into the cabin to maintain a habitable environment.

Large vehicles of the *ALUMINAUT* variety produced some unusually trying cabin condi-



Fig 9.8 Just prior to an aborted bottom excursion during *BEN FRANKLIN*'s Gulf Stream Drift the author, wrapped in a blanket and wearing a foam-rubber pad to cushion contact between his head and the steel-rimmed viewport, stares balefully at a fellow passenger. An LiOH panel and several 5-lb bags of silica gel can be seen in the background. (Grumman Aerospace Corp.)

tions when operating in the tropics. *ALUMINAUT*'s general operating procedure was to cast off the towline and transfer the observers by rubber raft from support ship to submersible. The observers were instructed to wear long pants and sweaters, because the cabin temperature would get quite chilly after a few hours in the 40° to 50°F bottom waters. When the passengers embarked, the interior of the vehicle had almost unbearably high temperature and humidity. Perspiration before the vehicle dived produced soaked clothing. When the vehicle reached operating depth and temperatures dropped, the wet clothing only served to aggravate the situation. The final solution was to embark in shorts, towel off at depth when the vehicle cooled and then change to heavier clothing which was kept dry within a plastic refuse bag.

Although submersible occupants have learned to cope with such conditions, there is still much to be desired in the way of permanent solutions that do not consume an inordinate share of the limited electrical power supply.

### Temperature Control:

Ambient seawater is the major influence on temperature within the pressure hull. The length of time it takes to transfer heat either into or out of the pressure hull depends upon the hull material. Figure 9.9 shows the temperature variations within the steel-hulled *BEN FRANKLIN* during its 30-day drift. Comparing this with ambient water temperature reveals a very close correlation. An examination of this plot shows another major temperature influence: During day 11 the propulsion motors were

turned on in an attempt to regain the Gulf Stream's central core, the four propulsion motors were activated and the effects of heat generated by their operation is shown by the wide variance between cabin and ambient temperature on that day. Electronic equipment is a positive heat source which can be an advantage during a deep dive in cold waters but a disadvantage on shallow dives in warm waters. Other sources of heat are the metabolic activities of the occupants themselves and the chemical reaction in the carbon dioxide scrubber compounds, which is exothermic. These contributions are also apparent in Figure 9.9 midday between days 12 and 13 when the vehicle was being towed back into the central core and all electronic equipment, except for the underwater telephone and a few scientific instruments, was turned off.

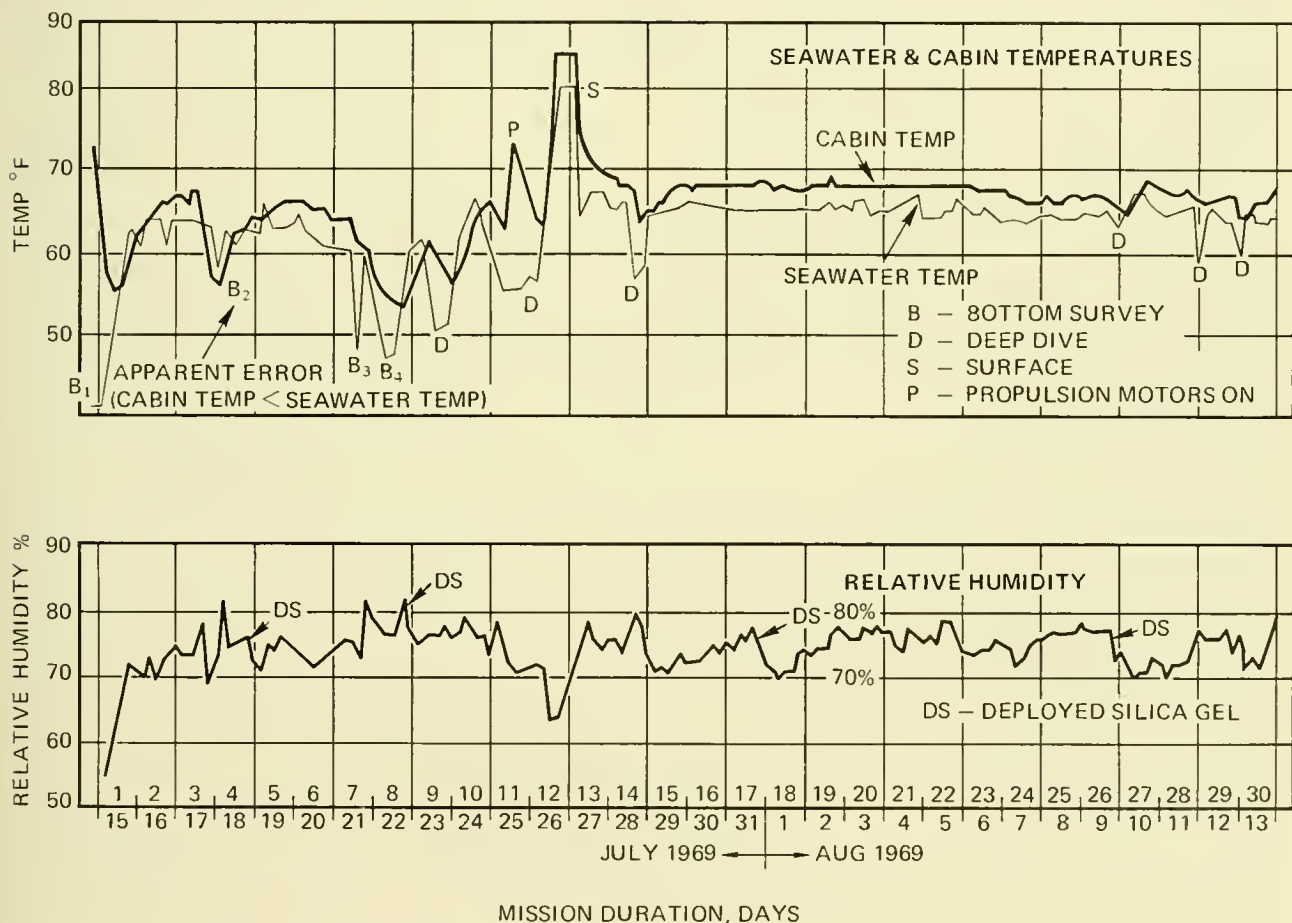

Fig. 9.9 Log of temperature and relative humidity for 30 days aboard *BEN FRANKLIN*. [From Ref. (16)]

Several approaches are taken to control cabin temperature: Hull insulation to retain heat; electric heaters to produce heat; air conditioners to remove heat; and circulation of cabin air along the colder pressure hull to cool it or across a block of ice to achieve the same result.

Insulating the hull is a practice in a few vehicles and is adequate as long as sufficient heat is being produced. Electric heaters are effective if the power they require can be spared.

Air conditioning serves both a cooling and humidity control function. Its use, however, is governed by available electric power. On **JOHNSON SEA LINK** the air conditioner's motor and compressor are housed externally in a pressure-resistant container and the condensers consist of tubular frames behind the acrylic sphere. Liquid freon enters the sphere through a penetration with a ball valve acting as a hullstop. Passing through the evaporator the gasses pass out of the sphere to the condenser via a return line with a check valve hullstop.

Because acrylic plastic has a low heat transfer coefficient, the air inside traps solar radiation and can produce extremely high temperatures. Operators within **NEMO** experienced temperatures of 120 °F and 85 percent relative humidity (13); consequently, a system was designed for both **NEMO** and its successor, **MAKAKAI**, to reduce such temperature extremes and maintain a low relative humidity as well.

**MAKAKAI**'s systems (14) consist of 25 pounds of ice stored in cannisters (under the operators' seats) over which air is circulated by fans. If the hull is covered until just prior to the dive the cabin temperature can be held at 82°F for 6 hours. The cooling system also removes water vapor from the atmosphere by causing it to condense on the cool ice containers. Various components of this system are shown aboard **NEMO** in Figure 9.10.

#### **Humidity Control:**

The major sources of water vapor in a submersible are the cabin air when the hatch is closed and respiration and perspiration of the occupants. Except for those vehicles with air conditioning, the control or low-

ering of humidity is accomplished by adding a desiccant to the carbon dioxide scrubbing compound, or by distributing small parcels of desiccant throughout the vehicle. From all available information, the only desiccant used is silica gel, and its effectiveness can be seen in Figure 9.9 which shows an immediate decrease in relative humidity following deployment of additional 5-pound, cloth-bound packages. Many of the random fluctuations in this figure correlate with temperature variations. Other variations (decreases) may be attributed to non-periodic but occasional massaging and shaking of the packets. By deployment of some 3,600 pounds of silica gel throughout the 30-day mission the humidity level was maintained at a comfortable level.

The effects of high humidity are more critical on equipment than on humans, especially when the internal temperature drops to a level where condensation occurs with subsequent drippage or collection of water on and within electrical components.

#### **Atmospheric Monitoring Devices**

The one area where the submersible community does not lack off-the-shelf instrumentation is in the means available to monitor the cabin atmosphere. A wide variety of compact, portable and inexpensive monitoring devices is available from the mining and aircraft industries, among others, which is more than adequate for submersible operations. There is no doubt that improvements can be made, but, for the present, progress in deep submergence is not thwarted by lack of atmospheric monitors. The variety of instruments from which to choose is reflected on the individual vehicles where few use the same devices. Consequently, only one or two instruments from each category are described.

#### **Oxygen:**

Two factors need be known with regards to oxygen: How much is in the flasks, and how much is in the atmosphere?

The simplest answer to the first question is the pressure gage arrangement shown in Figure 9.11. This system attaches directly to the oxygen flasks and is manufactured by National Cylinder Gas Corporation. The main components are a gage to show pres-

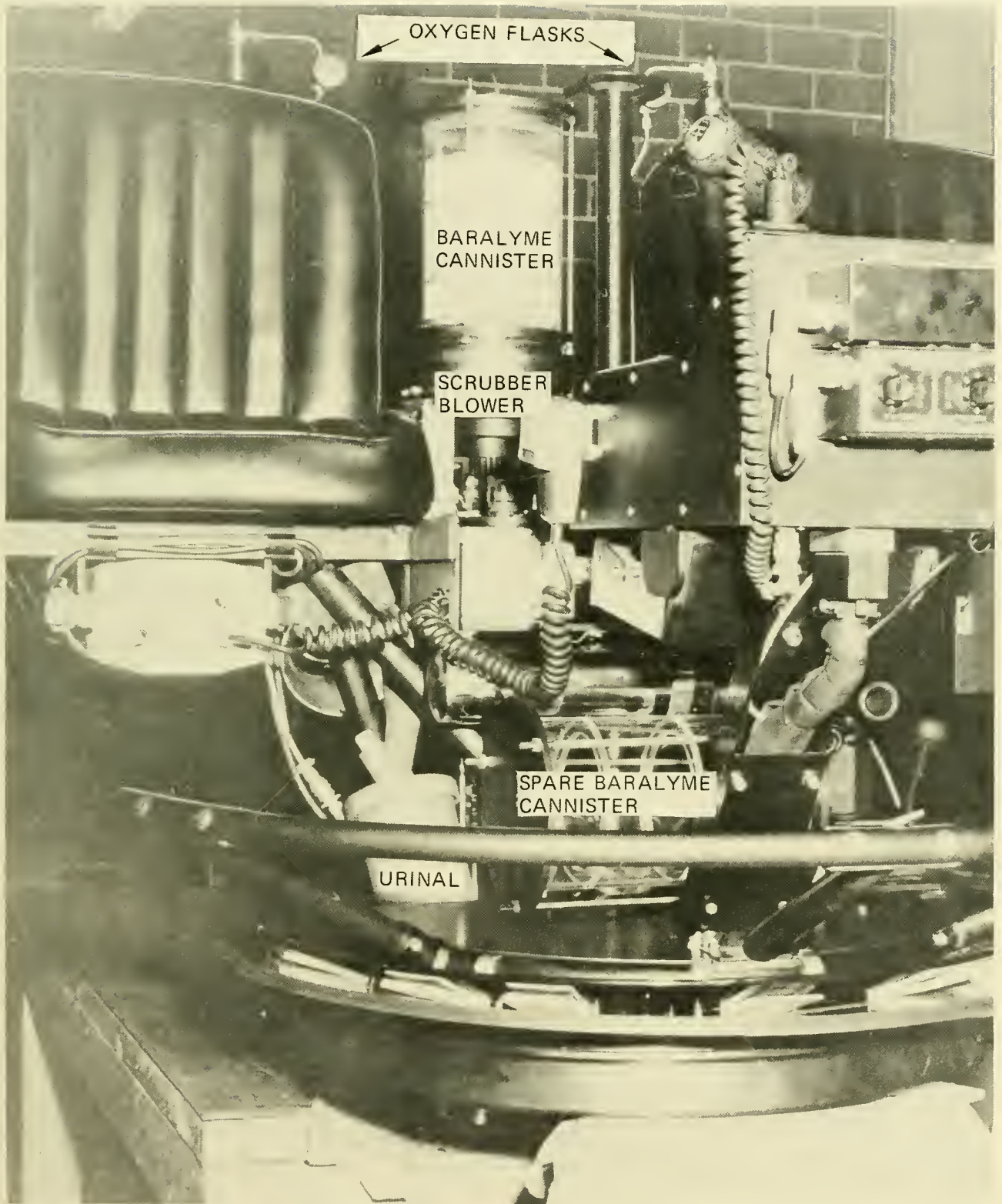

Fig. 9.10 Various components of *NEMO*'s life support system. (U.S. Navy)

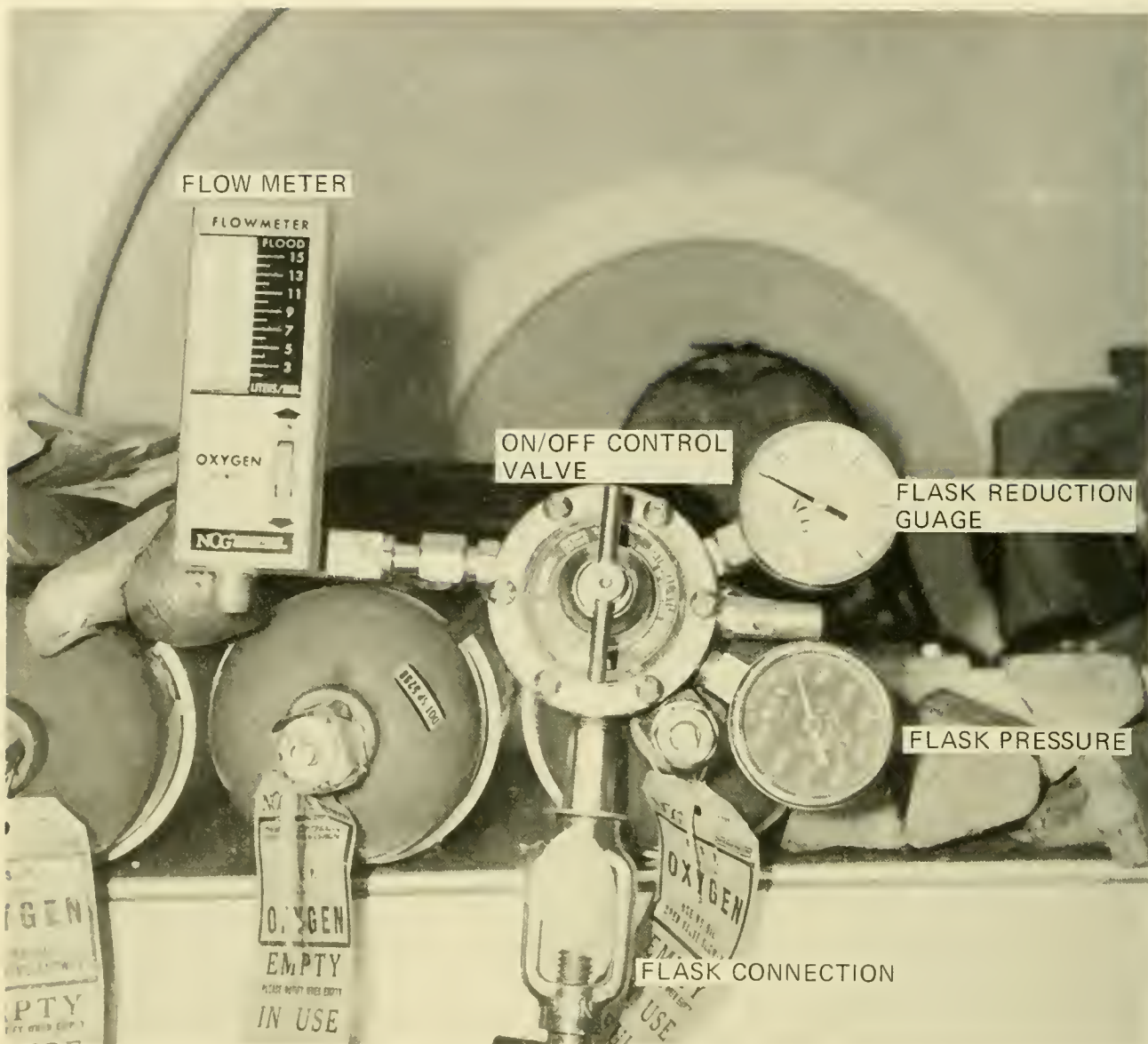

Fig. 9 11 Oxygen flasks and control/monitoring devices aboard PC-14

sure in the flask (0-4,000 psig), a valve to reduce the pressure as it comes out of the flask (0-100 psi) and a flow meter (0-15 lpm) to indicate and control the rate of oxygen released to the cabin.

A second arrangement is shown in Figure 9.12. In this Scott device the oxygen is introduced at one of the fittings at the top and circulates through the system, during which time flask pressure is measured (0-2,000 psi). Flow rate is controlled and monitored (SCFH at 10 psig and 70°F), and oxygen is fed into the cabin via the companion top fitting or

routed through piping elsewhere if desired. Quite frequently the readout portion of such systems is incorporated into the monitoring panel which is in easy view of the operator and does not require his moving about to check the gages.

Several portable devices are available to monitor the oxygen content in the atmosphere. Invariably these are polarographic sensors which indicate by means of a voltmeter.

Both the **JOHNSON SEA LINK** and **SDL-1** use the Biomarine oxygen monitoring sys-



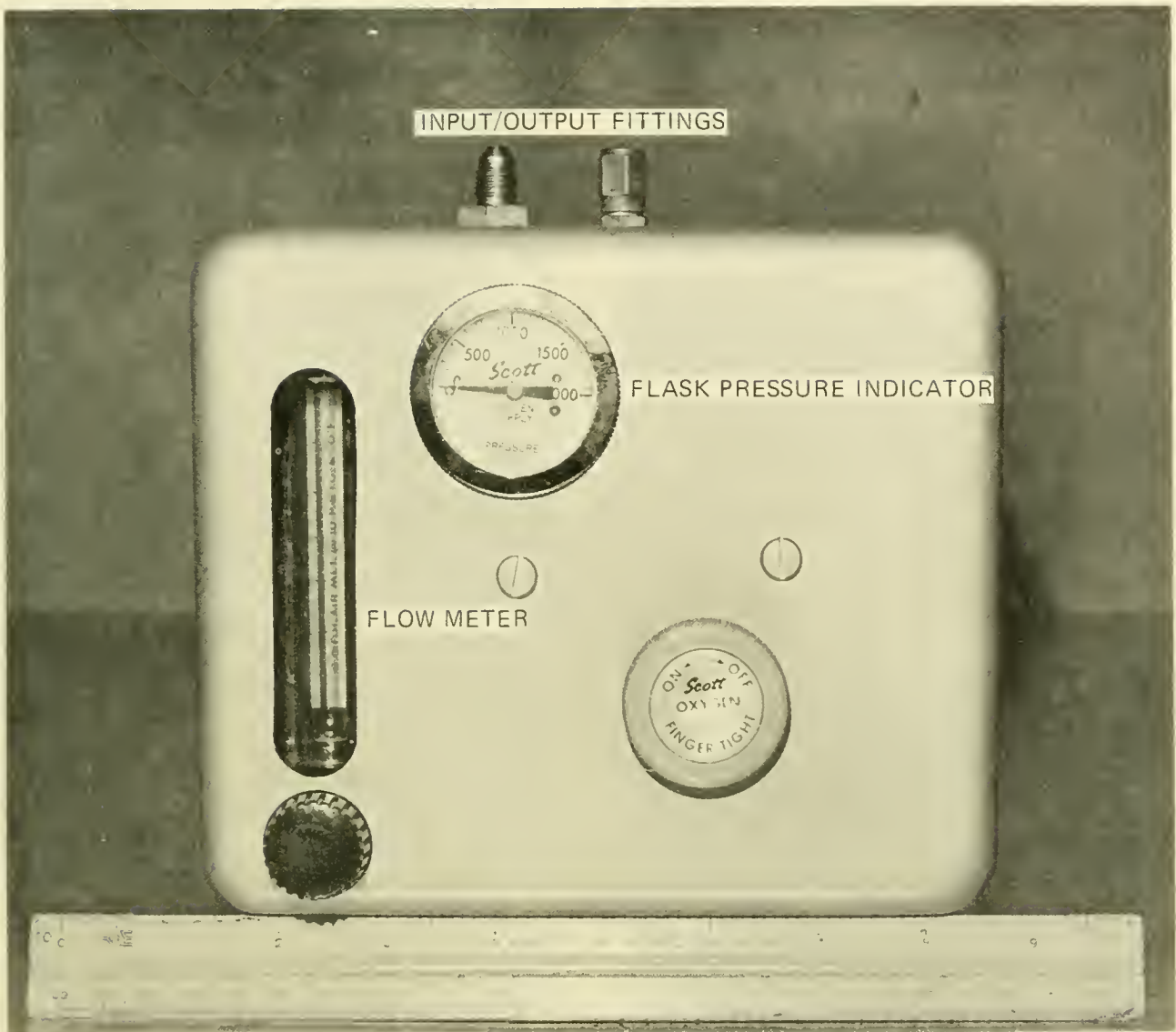

Fig 9.12 A flow meter and flask pressure indicator once used aboard ALVIN, but now replaced. (WHOI)

tem shown in Figure 9.13. This unit (model 202) reads from 0–100 percent oxygen or 0–1.0 absolute atmosphere of partial pressure. The oxygen is sensed directly by a galvanic cell containing a gold cathode and a lead anode in a basic electrolyte. Oxygen diffusing through the cell face initiates redox reactions which generate a minute current proportional to the oxygen's partial pressure. A remote sensor in the diver chamber allows the pilot to monitor either sphere or diver chamber oxygen concentrations.

The oxygen sensor in *DS-4000* was designed by Mr. Alan Krasberg in 1962 and

operates on the principle of a fuel cell. When molecules of oxygen impinge on the sensing element, a voltage is generated which is proportional to the partial pressure of the local oxygen concentration. This device indicates continuously on a 0–50 percent dial where a green ring spans the desired 17 to 25 percent range. The unit operates routinely off the main power supply (28 VDC drawing 0.1 amp), but in a power failure it has its own batteries which are kept charged by the main supply. The device is shown in Figure 9.14. Its accuracy is within the order of its readability,  $\pm 0.2$  percent.

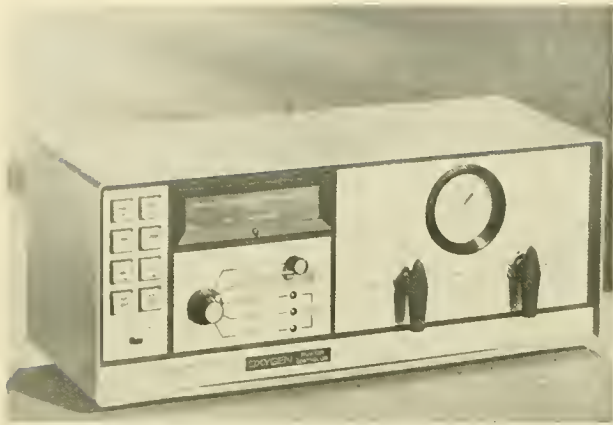

Fig. 9 13 Bio Marine Industries' automatic oxygen flow control and sensor unit. (Bio Marine, Ind.)

Other oxygen analyzing devices are commercially available from Beckman, Teledyne Analytical Instruments, Johnson-Williams and others. In some vehicles a second device is sometimes carried as a backup in the event of a malfunction in the primary device.

### Carbon Dioxide:

Monitors for detecting carbon dioxide range from the complex to the very simple. The U.S. Navy's *SEA CLIFF* and *TURTLE* carry both a fixed and a portable carbon dioxide monitoring device. The fixed monitoring device is manufactured by International Gas Detector Ltd. and reads from 0-5 percent with an accuracy of  $\pm 0.25$  percent. The analyzer contains two sealed chambers, each connected to one end of a nonspillable liquid manometer tube. One of the chambers contains a cartridge of soda lime, the other contains a dummy, or inert, cartridge. Atmosphere diffuses into the chambers through porous rings. The soda lime absorbs carbon dioxide creating a lower pressure in its side of the manometer and drawing the liquid up in that leg of the tube. The percent of carbon dioxide in the sample is read directly on a 0-to-5 percent scale behind the tube. A knob on the top of the unit is used to move the scale up and down behind the tube to zero the unit before use. Each chamber contains a small cartridge of cotton wool soaked with water to maintain equal vapor pressures in each side of the unit, thereby making it impervious to changes in humidity.

The portable analyzer is shown in Figure 9.15. It uses a liquid absorbent to remove carbon dioxide and indicates concentration by volume change. The unit is manufactured by F. W. Dwyer Company and is found in a number of submersibles. In operation, an aspirator bulb is used to force the air sample into the water saturation chamber through the sample line. The plunger valve is depressed while the aspirator pumps the sample in, thereby allowing the sample to pass down through the sample intake tube, out through the cross bores at the bottom of the intake tube, up through the distilled water in the water saturation chamber and over into the sample chamber. The sample is vented off to the atmosphere through a float on one



Fig. 9 14 Westinghouse-Krasberg oxygen monitor. (Mr. A. P. Ianuzzi, Naval Facilities Eng. Comm.)

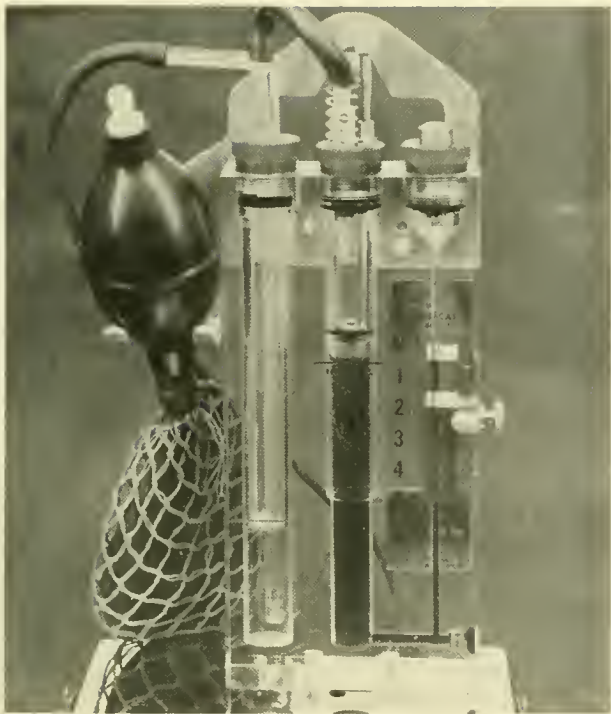

Fig. 9.15 The Dwyer portable carbon dioxide monitor (Mr. A. P. Ianuzzi, Naval Facilities Eng. Comm.)

side of the plunger valve. After the sample is pumped through the unit, the plunger valve is released, closing off both the atmospheric vent and the connection to the water saturation chamber. The  $\text{CO}_2$  is absorbed by slowly raising and lowering the absorption basket four times. The indicating tube is then vented to the atmosphere by depressing the vent valve until the fluid level comes to rest, then releasing it. The percent  $\text{CO}_2$  is read directly from the position of the fluid level on the calibrated scale. The instrument is reset for a new measurement by depressing both the plunger valve and the vent valve until the fluid is balanced. The unit is zeroed by sliding the scale vertically by means of the zero adjusting nut.

Several other portable and hand-held devices can be used, not only for carbon dioxide monitoring, but for other atmospheric contaminants as well. *DS-2000* carries both a Kitagawa and a Mine Safety Appliances carbon dioxide testing kit as backup for its primary Dwyer monitoring system.

Using the pump shown in Figure 9.16, a sample of atmosphere is drawn into a glass phial within which a granular reagent shows concentration of carbon dioxide by color change. Similar in design is a Dräger Multi-Gas Detector which, by inserting the proper phials, can measure a wide variety of atmospheric trace contaminants.

#### Temperature and Humidity:

In order to avoid the possibility of contamination from spilled mercury, only bimetallic temperature sensors are acceptable. A number of vehicles use a relative humidity indicator manufactured by the Bacharach Instrument Co. of Pittsburgh, Pa. Both temperature and humidity measurements have been combined by Bacharach into one instrument with a readout for both variables. In the model used aboard *SEA CLIFF* and *TURTLE* (Bach. Code 22-4529) temperature is indicated from  $0^\circ$  to  $130^\circ\text{F}$  ( $\pm 1^\circ\text{F}$  accuracy from  $32^\circ$ – $130^\circ\text{F}$ ) and relative humidity from 0 to 100 percent ( $\pm 3\%$  accuracy from 15 to 90% RH  $32^\circ$  to  $130^\circ\text{F}$ ). The design of the temperature sensing element is based on a conventional spiral-wound, bimetallic spring connected to a pointer. The humidity sensing element consists of a hygroscopic animal



Fig. 9.16 A Kitagawa  $\text{CO}_2$  detection kit used as a backup system aboard *DS-2000*



Fig 9 17 Cabin pressure indicator (Altimeter). (Mr. A. P. Ianuzzi, Naval Facilities Eng. Comm.)

employed is a sensitive aircraft altimeter (Fig. 9.17). A regular barometer is limited in range. Altitude (pressure) changes are caused by variations in oxygen or carbon dioxide within the cabin; in *DOWB* (140 ft<sup>3</sup> internal volume) a one percent increase in either will cause a decrease in altitude of 277 feet (15). Unfortunately, temperature and relative humidity changes are also reflected on the altimeter and a means for correcting the altimeter for these changes must be provided if concentration of gasses is desired.

Inadvertent or accidental pressure buildup to the point where decompression would have been required has never been reported; in most cases the buildup is slight, but sufficient to be noticed on the ear drums when the hatch is opened following a 6- or 8-hour dive. The possibility that such a buildup might occur can bear on the methods used to

membrane clamped between a pair of aluminum retaining rings. A spring-loaded linkage assembly is connected with the center of the diaphragm, pulling it into a conical shape. The other end of the linkage is connected to the indicating pointer. Since the diaphragm is sensitive to moisture in the surrounding air, changes in humidity cause proportional changes in its dimensions. Movement of the apex of the diaphragm is transmitted to the pointer through mechanical linkage. The unit does not require maintenance or adjustments.

#### Cabin Pressure:

Ascertaining the atmospheric pressure within the cabin is important for crew comfort (a sudden decrease in pressure when the hatch is opened may be quite painful) and safety (undetected buildup of pressure might reach proportions requiring decompression). Additionally, the oxygen flow rate in many vehicles is usually adjusted by noting changes in cabin pressure. There are a number of devices which can be used to measure pressure changes, but the one most widely

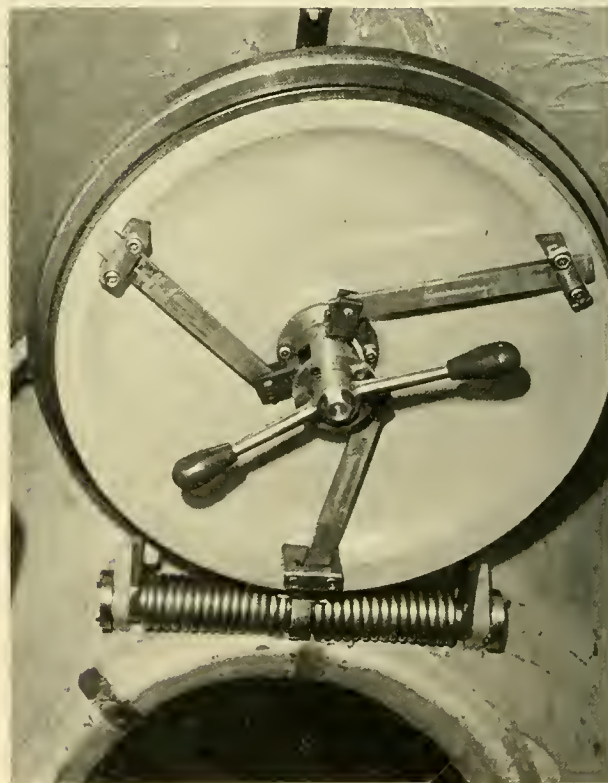

Fig 9 18 Two different methods of securing a hatch cover. a) DS-2000, b) AQUARIUS I. (a Westinghouse Corp.)



secure the hatch cover. On a number of vehicles the hatch cover is secured to the hull by metal clips which extend from the hatch cover into and tangential to the pressure hull. An example of this type of arrangement is shown in Figure 9.18a. With this method pressure could build to a point where, when the vehicle is surfaced and free of hydrostatic pressure, the hatch cover could be forced upward sufficiently to inhibit retraction of the securing clips. An alternate solution might be to undog the hatch when submerged, but this may lead to explosive depressurization when nearing the surface. To overcome the problem where the hatch could not be undogged due to high cabin pressure, International Hydrodynamics has derived an alternative securing method which is shown in Figure 9.18b and is used on *AQUARIUS I*. This method consists of a thick rubber strap affixed into a clip inside the pressure hull. The philosophy here is that the only time the hatch cover needs to be held secure is when the vehicle is on the surface (the strap provides this function) and that ambient pressure will keep it closed when the vehicle is submerged.

To solve the pressure problem a number of vehicles provide a thru-hull pressure relief valve which allows the operator to relieve the pressure when surfaced without opening the hatch and at a desired rate. *BEN*

*FRANKLIN*, for one, had such an arrangement which could be used to "burp" the pressure hull if so desired.

While submersible diving history shows no evidence of internal pressure buildup to dangerous proportions, there is always the possibility that it can occur and the seemingly simple task of securing a hatch cover may have important repercussions.

### Philosophical Approach; Two Examples

The duration, control and monitoring of life support systems is finalized, not only on the basis of the number of occupants, volume of the cabin and length of dives, but also on the operator's philosophy concerning safe diving practices. Most operators agree on the following: A supply of oxygen, a carbon dioxide removal system and monitors for atmospheric pressure, oxygen and carbon dioxide. But there are extremes on both sides—e.g., the *K-250* and *BEN FRANKLIN*. The former relies on nothing but air within the cabin; the latter supplies virtually every need for life support. Before examining these two examples, attention is directed to a paper by Mr. A. P. Ianuzzi (10) who describes the philosophical and technical considerations that went into the design of *DS-4000*'s life support system. Ianuzzi's report is an excellent example of the considerations and trade-offs a submersible designer must confront in life support design and is recommended as a practical primer for the neophyte.

Most submersibles provide a life support system paralleling that of the *DS-4000*, but on both sides of this system are extremes which are derived by virtue of the dive time. *K-250* has a 1½-hour dive duration; *BEN FRANKLIN* has a 30-day duration. *BEN FRANKLIN* remained under longer than any other submersible and its life support system is described because it was highly successful and required virtually no electrical power. Additionally, the results of the system's effect on the crew members were exhaustively examined and documented; hence, there may be one or more features of this proven system which may be of value to future designers and present operators. *K-250* is discussed primarily because it represents a radical variation from every other design and the designer states why in detail.

The designer and builder of these 1-man, 250-foot vehicles is Captain George Kittredge, USN (Ret.) of Kittredge Industries, Warren, Maine. Several *K-250*'s have been built and sold, and Captain Kittredge offers a 15-page brochure (for a nominal fee) which relates the vehicle's design, his history as a builder and his personal philosophy as regards design of various submarine systems. Kittredge's naval experiences included a tour of duty as commanding officer of a Navy submarine, so he comes into the submersible field with credentials as appropriate as any. For this reason it is interesting to examine an approach to life support which is radically different from those of all of his associates in deep submergence; the following quote is from his brochure entitled *K-250*.

*"From time to time, people ask us what we do about air for breathing in our submarines. The answer is that we use the same method that was used in U.S. Navy submarines during World War II: namely, we breath the atmosphere inside the submarine. Theoretically, there is sufficient oxygen in the atmosphere inside the submarine to last six hours; however, in actual practice we recommend surfacing and reventilating every hour. This takes less than five minutes and is the easiest, simplest, and safest thing to do.*

*We do not recommend carrying compressed oxygen in the submarine for two reasons. A leak in the oxygen system would build up an internal pressure in the submarine and could prove toxic to the operator. Secondly, an oxygen enriched atmosphere could result in a fire hazard. While oxygen itself will not burn, it supports combustion. The space capsule fire that took the lives of three astronauts is a good example of what can happen when you have an oxygen enriched atmosphere in a confined space. Nor do we recommend the use of CO<sub>2</sub> absorbent in our submarines. CO<sub>2</sub> absorbent can defeat the only means a human body has of detecting "bad air." Almost everyone has, at one time or another, been in a crowded room*

*and heard someone say, "It's getting stuffy in here. Let's open a window." What actually happened in such a case, was that the level of CO<sub>2</sub> in the room had built up and increased the acidity of the blood. That part of the brain known as the "obligata medulla" detects an increase in the acidity of the blood. Thus, the human body can detect a high concentration of CO<sub>2</sub> but it cannot detect a deficiency of oxygen. The most dangerous thing that could be done in the above example of the crowded room, would be to use CO<sub>2</sub> absorbent.*

*So this is the system we recommend. Surface and ventilate the submarine every hour or more often if you "think" the air in the submarine is getting foul. This is the safest, simplest, and least expensive procedure to follow."*

From a technical point of view Kittredge's philosophy is unassailable. The *medulla oblongata* will indeed warn of excess carbon dioxide, but if one reviews the incidents related in Chapter 15, there are times when the window in the submersible's "stuffy room" cannot be opened. Captain Kittredge's approach to life support stands alone in the field of deep submergence.

#### **BEN FRANKLIN:**

Relative to military submarines, which can stay routinely submerged for 60 days, **BEN FRANKLIN**'s 30-day submergence was no record-breaker. However, a nuclear submarine, in regards to life support, differs from **BEN FRANKLIN** in the following: It extracts oxygen from seawater; it removes carbon dioxide through a process not requiring vast stores of scrubbing compound; trace contaminants are automatically monitored and controlled; heaters and air conditioning control the atmosphere; food is stored and prepared as it is on surface ships; water is manufactured onboard; metabolic wastes are stored and then dumped overboard; and space, though not overexcessive, is in greater abundance. The reason for these differences resides in a nuclear submarine's abundant electrical power and great size relative to the 750-kwh, 49-foot-long **BEN FRANKLIN**.

The operation and success of *BEN FRANKLIN*'s life support and a variety of other human aspects in deep submergence are analyzed in detail in a five-volume report prepared by Grumman Aerospace for NASA;

the following information and figures were extracted from these (ref. 16 and ref. 17) and from personal experiences of the author. A collection of photographs showing various features and activities during the drift is

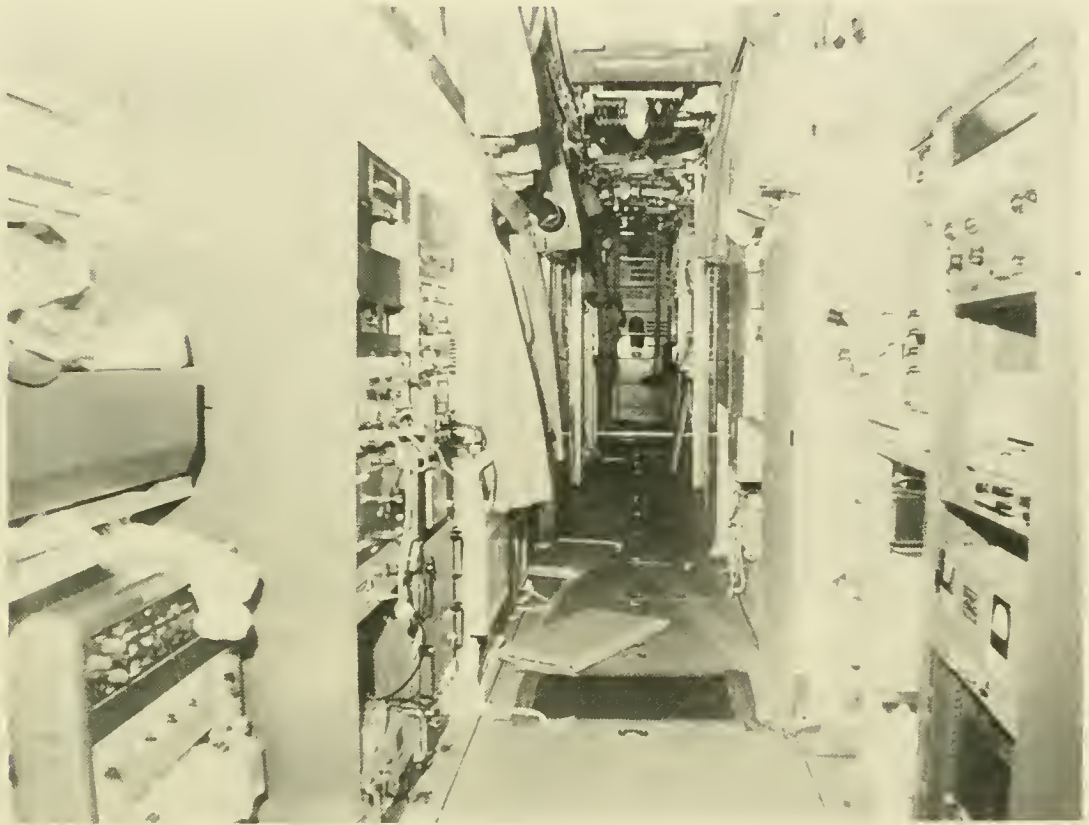

Fig 9 19 Assorted activities aboard *BEN FRANKLIN* during and prior to its 30-day drift in July-August 1969.  
a) Interior view looking forward from the aft hemi-head. (Grumman Aerospace Corp.)



b) Co-pilot Erwin Abersold at work in the forward hemi-head (wardroom). Also shown is the LOH panel and bags of silica gel. (NAVOCEANO)



c) The "continental" shower and washroom facilities. (NAVOCEANO)



d) NASA crewman Chester May with a Drager tube. (NAVOCEANO)



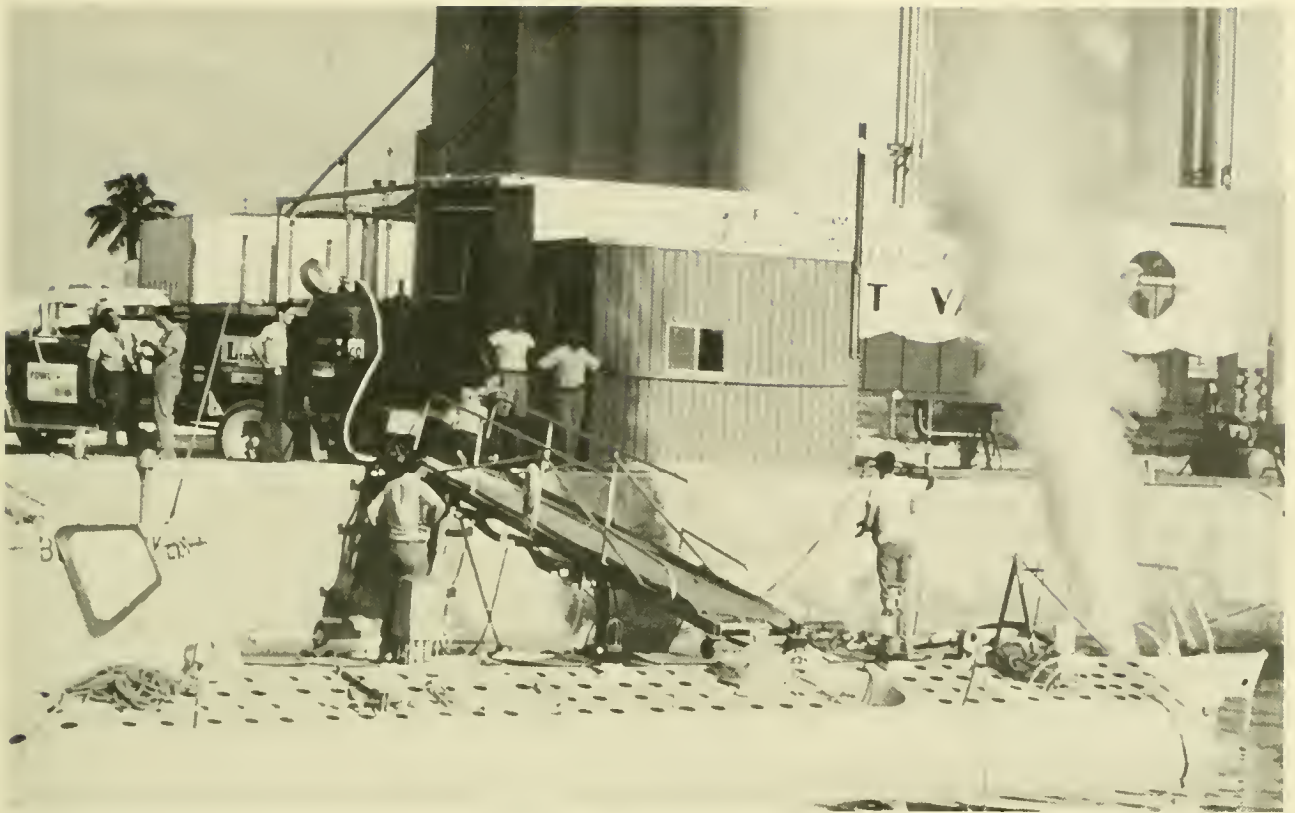

e) Venting off liquid oxygen at West Palm Beach, Fla. (NAVOCEANO)



f) Crewman at the forward viewports during a bottom excursion. (NAVOCEANO)

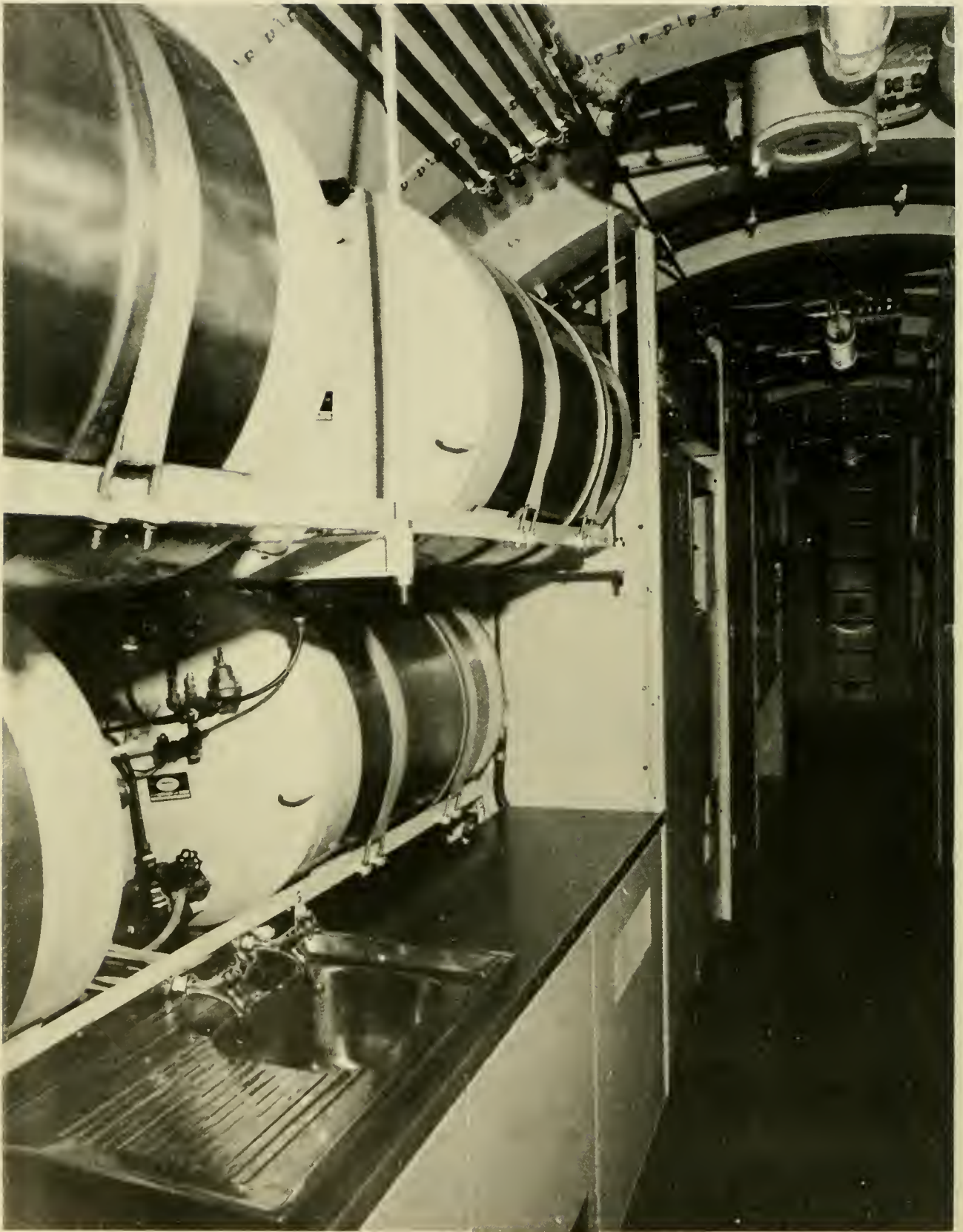

g) Hot water tanks and galley area. (Grumman Aerospace Corp.)



h) Oceanographer Kenneth Haigh in scientific area. Silica gel bags hang overhead. (NAVOCEANO)



1) Jacques Piccard and Abersold with a hollow glass sphere filled with biological samples and locked out of the vehicle for retrieval by the support ship. (NAVOCEANO)

presented in Figure 9.19. A list of the atmospheric monitoring and instruments and their application is shown in Table 9.7, and the interior layout of the vehicle is in Figure 9.20.

### **Carbon Dioxide Removal**

Carbon dioxide removal was performed without electric power by absorption on LiOH panels strategically located throughout the vehicle. Diffusive and natural convection currents circulated the atmosphere through the panels. Three portable blowers were included as part of the system to be used to aid in circulation during those periods in which natural convection was not adequate.

Once the vessel was sealed, carbon dioxide readings were taken every 4 hours with a

Dwyer Analyzer. This instrument failed and a Fyrite Analyzer and a CO<sub>2</sub> Drager tube were used instead.

### **Oxygen Supply and Regulation**

Oxygen was stored as a cryogenic liquid in two standard Linde LC-3GL cylinders, each holding up to 250 pounds. Operation of the system required that oxygen consumption be greater than normal oxygen boiloff to prevent a hazardous buildup in oxygen partial pressure. Normal boiloff is approximately 3.75 pounds/tank/day.

### **Temperature Control**

Because of moderate Gulfstream temperatures (average water temperature 59°F), temperature control for the mission was passive. Using the sea as a heat sink, bare sections of the hull's interior surface conducted heat out of the vessel. Internal tem-

TABLE 9.7 ENVIRONMENTAL MEASUREMENTS [FROM REF.(16)]

Item	Reading	Freq	Instrument	Operation	Power Watts
Oxygen	Percent	2 hrs	Teledyne O <sub>2</sub> Sensor	Continuous	0
Carbon Dioxide	Percent	4 hrs	Fyrite CO <sub>2</sub> Analyzer	Manual	0
Pressure	Atmosphere	4 hrs	Pressure Gage	Continuous	0
Temperature					
Internal	° Fahrenheit	4 hrs	Abeon-Gage	Continuous	0
External	° Centigrade	4 hrs	Trub, Tauber, Cie Gage	Continuous	0
Relative Humidity	Percent	4 hrs	Abeon-Gage	Continuous	0
Trace Contaminants					
° Metabolic	*PPM	24 hrs	Drager Gas Detector Tubes	Manual	0
° Other	*PPM	1 wk	Drager Gas Detector Tubes	Manual	0
Oxygen	*PPM	72 hrs	UNICO-PGC-Series/D Gas Chromatograph	Manual	200 (1 hr)
Nitrogen					
Carbon Dioxide					
Carbon Monoxide					
Methane					
Hydrogen Sulfide					
Hydrogen					

\*Parts per million

peratures during the mission were shown in Figure 9.9, and the effectiveness of the temperature control method has been discussed.

**Humidity Control**

Humidity control was accomplished passively by allowing moisture to condense on the bare sections of the hull's interior. As the moisture was condensed on the hull it ran into a catch trough which carried it into the waste water storage tank. A small dehumidifier was available but was not used. A 3,600-pound supply of silica gel in 5-pound bags

served to absorb moisture. The results of this method were also discussed and graphed on Figure 9.9.

**Atmospheric Pressure**

Under normal operating conditions, the internal pressure of *BEN FRANKLIN* varied from a low of 13.5 psia to a high of 16 psia. These changes can be expected when the sea level temperature varies greatly from vehicle interior temperature. Slight pressure changes of 10 to 25 mmHg can be incurred by normal variations in O<sub>2</sub>, CO<sub>2</sub>, and H<sub>2</sub>O partial

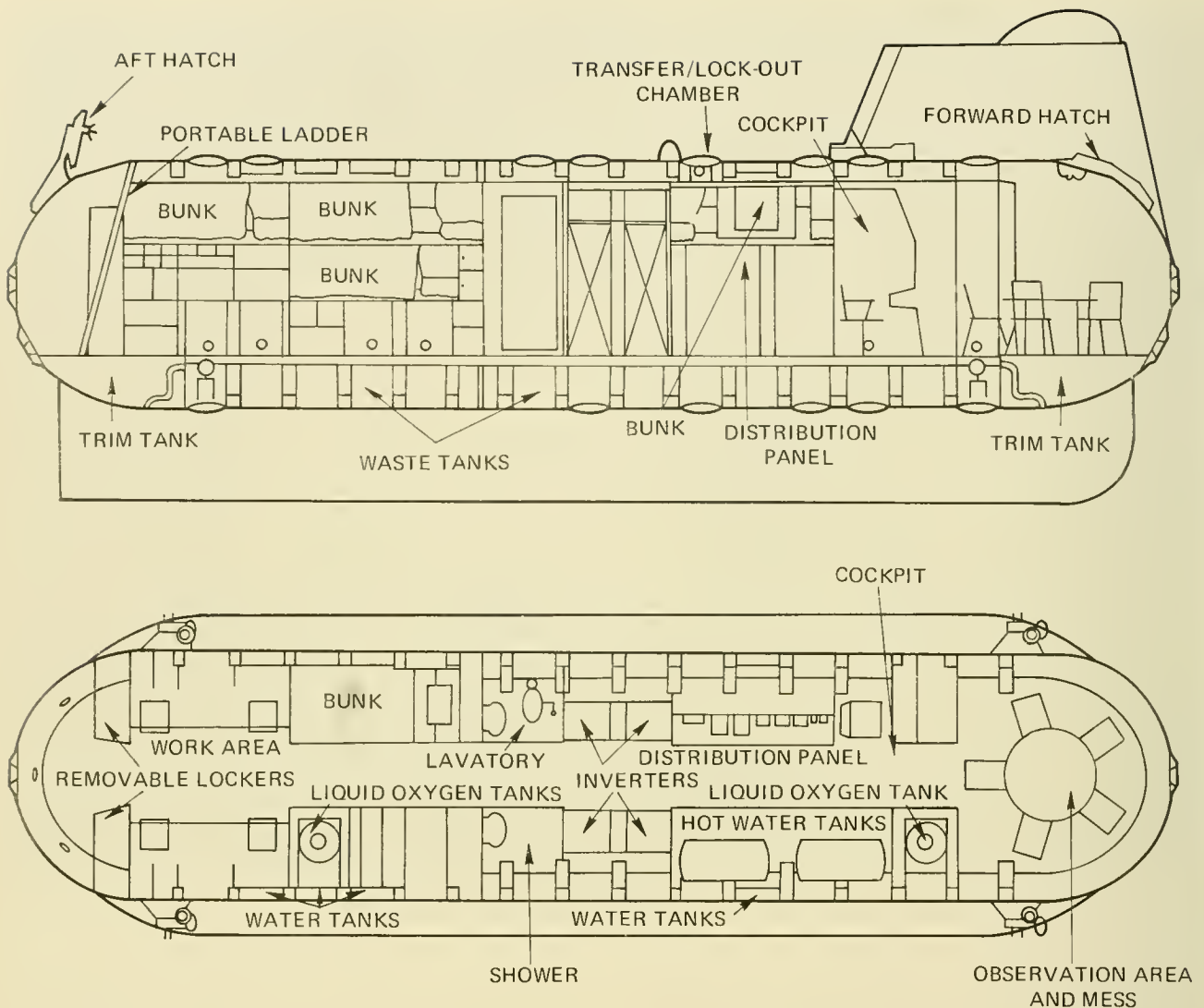

Fig. 9.20 Interior layout of BEN FRANKLIN. [From Ref. (16)]

pressure. Pressure was indicated by a helioid compound pressure gage.

#### Contaminant Removal

Contaminant removal was accomplished in the following manner:

- Continuous passive removal of contaminants by LiOH and activated charcoal, both of which are provided in the CO<sub>2</sub> removal panels.
- Intermittent active removal of contaminants by the odor removal (Purafil) cartridge in the toilet.

- Periodic active removal by the portable contaminant removal system (operated as needed) containing Kalite, Hopcalite and Acamite cannisters.

Contaminants removed by each of the above are the following:

- LiOH—In addition to its primary function of removing CO<sub>2</sub>, LiOH also removed acid fumes such as hydrochloric acid and hydrogen sulfide.
- Activated charcoal—A small quantity of activated charcoal was provided along with the LiOH in the CO<sub>2</sub> scrubbing

panel and in each of the portable contaminant removal system cannisters. It absorbed organic vapors, odors and ammonia.

- Purafil—This material is pelletized activated alumina impregnated with potassium permanganate. Purafil removed odors, organic vapors, organic acids, phenols, sulfides, and nitrogen oxides.
- Hopcalite—A catalyst with the primary function of oxidizing carbon monoxide to carbon dioxide (also handled aldehydes, alcohols, etc.).
- Acamite—Absorbed alkaline fumes ( $\text{NH}_3$ ) and also acted as a drier.
- Kalite—Absorbed acid fumes ( $\text{HCl}$ ,  $\text{H}_2\text{S}$ , etc.).

### Waste Management System

The waste management system chemically treated and stored metabolic wastes onboard the vessel. As the toilet flushed, germicide was automatically metered into the exit stream. The wastes then entered a macerator where they were simultaneously pulverized and thoroughly mixed with the germicide. The treated wastes were held in the macerator between toilet uses. It was during this period that biological organisms were inactivated. Wastes were then pumped from the macerator into the waste storage tank where they remained.

Toilet odors were handled by a blower which drew air through a cannister filled with Purafil. Storage tank odors were handled by a vent line that fed into the odor removal cannister. Two waste tanks were installed—a “mini waste” tank and a “waste storage” tank. The mini waste tank collected water from the three sinks and shower. This tank stowed the water for use in flushing the toilet.

### Contaminant Detection

Trace contaminant detection was accomplished with Drager type gas detector tubes, a method requiring no power. Forty different tubes, many of which detect more than one contaminant, were available. Measurements were made by breaking the tops off of the tubes and inserting the tubes into a hand operated bellows pump.

### Atmosphere Exchange System

The function of the atmosphere exchange system was to purge the vehicle's atmosphere and replenish it with fresh air. The system consisted of a portable blower attached to approximately 30 feet of flexible ducting. The system was to be used when:

- Smoke due to a fire or insulation breakdown filled the vehicle.
- The carbon dioxide level reached 3.0 percent.
- The oxygen partial pressure reached a hazardous level.
- A trace contaminant level built up and could not be removed by the contaminant removal system.

### Potable Water System

The potable water supply consisted of both hot and cold water (Fig. 9.21). The cold water was stored in four saddle tanks each of which held approximately 95 gallons and the hot water was stored in four super insulated tanks each of which held 50 gallons. The tanks were initially filled with cold fresh water from dockside. Two inline filters removed gross particles and bacteria. A second bacterial filtering was performed as water was drawn from the cold water tanks by another filter on the cold water discharge line. Hot water was prepared by using the electric immersion heaters in the insulated tanks.

### Food

The food supply on *BEN FRANKLIN* consisted of commercially obtained freeze-dried meals, the preparation of which entailed mixing with water. Five different menus for

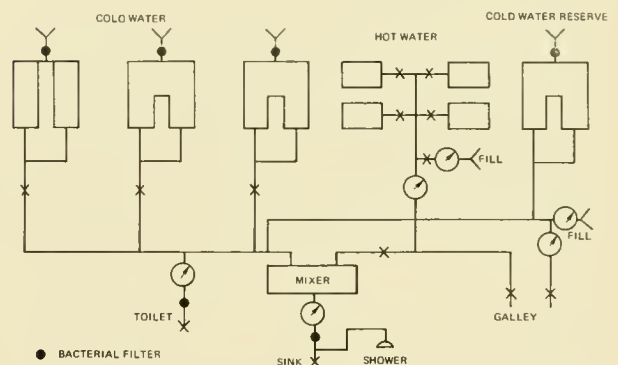

Fig. 9.21 Water management system on BEN FRANKLIN. [From Ref. (16)]

breakfast, lunch, dinner and snacks were provided. A sample for each is shown below.

The results of *BEN FRANKLIN's* life support system, as mentioned, are thoroughly and exhaustively discussed in reference (16), and the reader is referred to these analyses for detailed information. Therefore, only highlights of the various life support features follow.

A plot of oxygen level, carbon dioxide and cabin pressure throughout the mission (Fig. 9.22) shows that the oxygen level remained between 19.5 and 22 percent. All adjustments were made manually with the flowmeter. The automatic control, originally part of the system, was disconnected to eliminate the need for an inverter and thus conserve electrical energy.

The carbon dioxide level was maintained between 0.4 and 1.5 percent. The anticipated buildup rate scheduled that the LiOH panels be changed every 2.5 days; but, the actual

need was closer to every 3 days. Subsequent analysis yielded a carbon dioxide generation rate of approximately 1.7 pounds per man day.

Atmospheric pressure ranged between a low of 1.01 atmospheres at the start of the mission to a high of 1.12 atmospheres. The highs occurred twice, once when the boat surfaced and was under tow, and again at the end of the mission. After the first day, a slight air leak in the pressure regulator from the variable ballast tanks was detected and corrected. Cabin pressure then increased to 1.025 atmospheres. Subsequent variations were due to temperature changes which correlate with ambient temperature at various depths.

Temperature and humidity variations have been discussed. It is significant that the data evaluators recommended insulation and heaters for cold water work.

Throughout the mission, contaminants were checked on a daily and a weekly basis. After some 5 days, carbon monoxide started

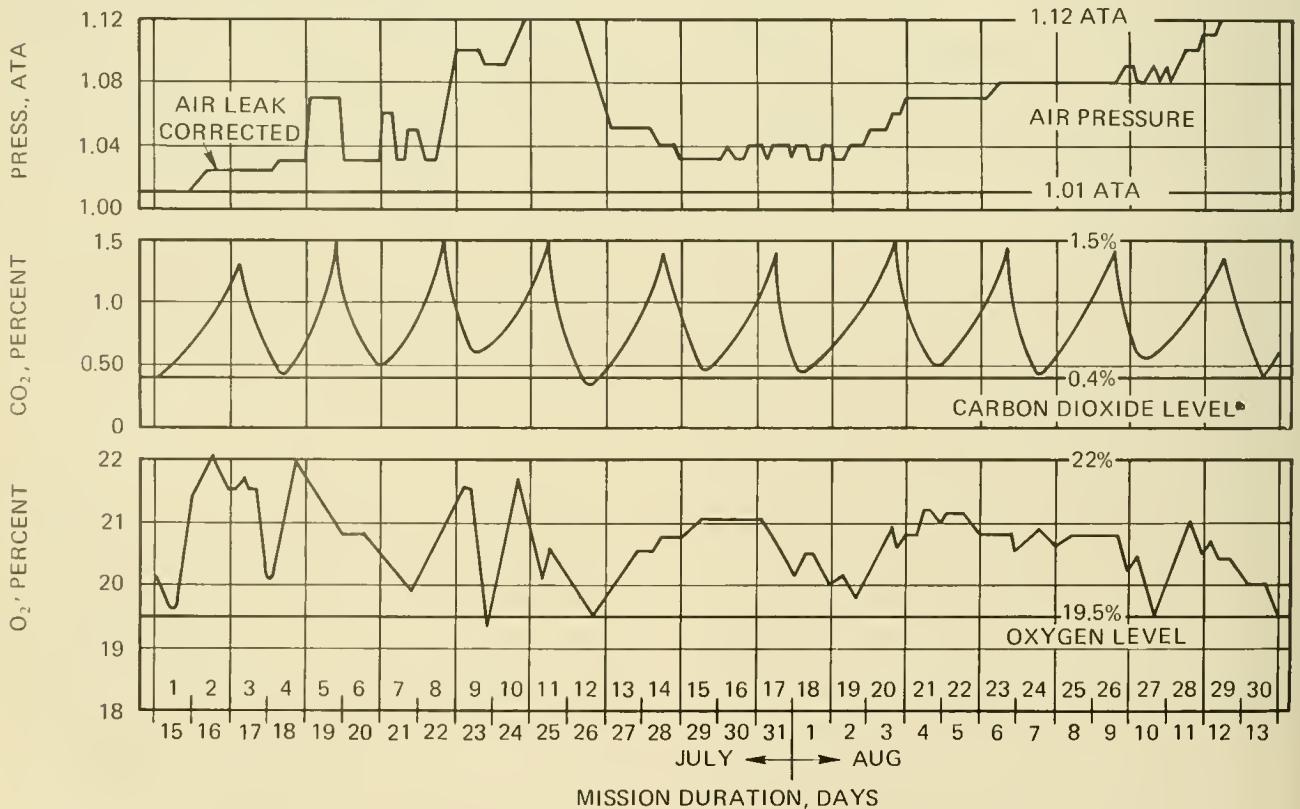

Fig. 9.22 Log of air pressure, CO<sub>2</sub> and O<sub>2</sub> inside BEN FRANKLIN. [From Ref. (16)]



to show up (8 ppm). The carbon monoxide level continued to rise and when it reached 20 ppm the active contaminant removal system was operated, but with no effect. The level continued to build up and by mission end it was 40 ppm. The carbon monoxide level projected for the 6-man, 30-day mission was approximately 34 ppm. In the first full contaminant check (Day 8) a trace (0.2 ppm) of ammonia and 200 ppm of acetone were detected. Periodic rechecking of these two items throughout the mission showed little change.

Cold water was used primarily for personal hygiene and for washing dishes (1 gal/day). Very little cold water was consumed in drink or food preparation primarily due to the cool temperature of the vessel and the repugnant taste of the iodine-treated water. In fact, cold water consumption was so low that it was necessary to run it periodically just to keep the mini waste tank from going dry.

The mission was started with two of the four hot water tanks not working properly, in that the vacuum had been lost, and the tanks cooled rapidly. Water was drawn from one of the defective tanks on the first day, after which it was necessary to switch to the two good tanks. Approximately 20 to 22 days later the hot water was depleted and it was necessary to reheat water for food preparation.

Acceptance of the food by the crew was varied. Many items were not enjoyed because the water was not hot enough to prepare the food properly. A few of the items were totally rejected on the basis of flavor or consistency (biscuits, milk shakes, chocolate bars). The overall consumption by the crew was less than planned (about 2,300 calories per day) and four of the six crew members lost an average of 11 pounds each, while two showed no change. Of the four who lost weight, one used the mission as an opportunity to diet and two others drew heavily from their personal cache of dried fruit and nuts, using the freeze-dried foods for dinner only.

The 30-day drift of *BEN FRANKLIN* provides the only data available for long-term life support in a contemporary submersible. While this submersible's life support system may not be the ultimate, it did provide all requirements for the crew who emerged in

good health and good spirits. For this reason one might consider utilizing various life support features of *BEN FRANKLIN* in present or future vehicles.

## HABITABILITY

Mr. Wesley Blair of Lockheed Corporation presented a comparison of the space available (free volume) per occupant in several submersibles versus the space available in a variety of other familiar human habitations (18). Blair's comparison is reprinted in Figure 9.23 and shows, for example, that a commercial coffin offers more free volume than the bathyscaph *TRIESTE*; the other submersibles in this figure barely exceed the coffin's volume.

Of the small contemporary vehicles, Texas A&M's *PC-14* is more or less representative of volume available, and a glance at the observer's position in Figure 9.24 reveals that space is at a premium. Shifting our attention to the interior of *PC-8* (Fig. 9.25), which is similar in diameter to *PC-14*, a wide variety of hard, sharp projections are seen from which the occupants will undoubtedly receive several whacks, bumps, pricks and jolts before the dive is over. The Perry vehicles are not unique, however, in their potential for discomfort, for all small submersibles offer similar jarring possibilities.

Rather surprising is the fact that even the large vehicles offer little in the way of human comfort. *BEN FRANKLIN*, for example, had a metal escape trunk in the stern that projected some 2 to 3 feet down into the pressure hull when in a stored condition. The hard, unforgiving nature of the trunk's rim was sorely researched and evaluated on the head and shoulders of the occupants until relief, in part, arrived in the form of foam rubber padding.

In the very small vehicles, such as *TECH-DIVER (PC-3B)*, head-bumping, knee-cracking and shoulder-whacking are much reduced, because the internal volume is so small that the occupants are forced to sit still until the need to stretch becomes almost unbearable.

The point being made, unfortunately, is that manned submersibles are not designed for comfort, and the smaller the vehicle, the

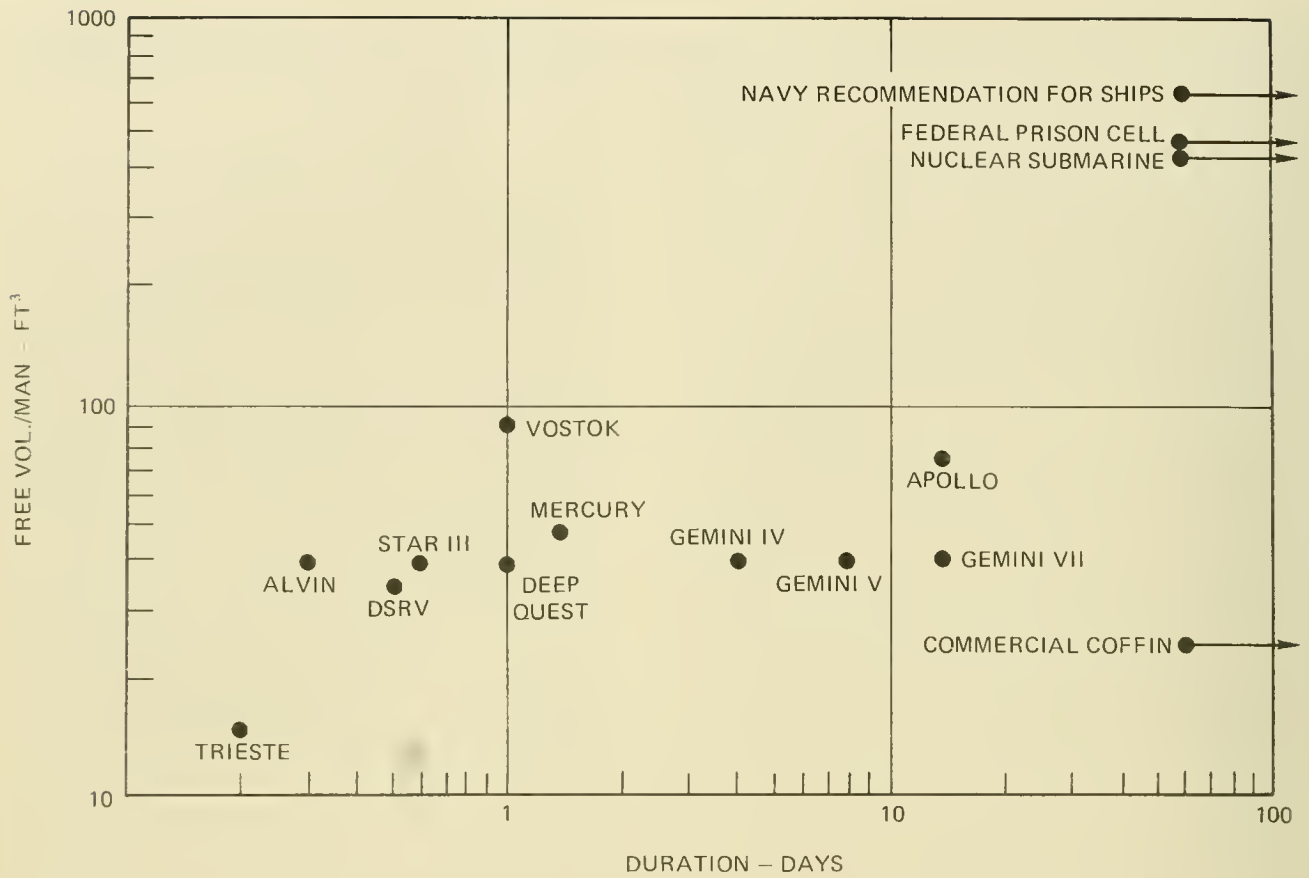

Fig. 9.23 Comparison of operator free volume in various manned systems. [From Ref. (18)]

more this fact becomes apparent. While most designers take great pains to sustain life, they have made few attempts, beyond providing foam rubber cushions, to make life comfortable.

Such considerations may seem trivial in view of the fact that the dive may last only for several hours. But, several hours may seem interminable when one is required to spend them in a position such as the observer is required to maintain in *ASHERAH* (Fig. 9.26). It is not difficult to imagine that the human's ability to endure this position will expire far more rapidly than will the electrical or life support endurance. The advent of the acrylic plastic hull and bow dome has gone far to alleviate the problem, but there is still much room for improvement.

The most reasonable approach to human factors design is through the use of mockups of the pressure hull and its equipment. With mockups the operator and observer can physically test the vehicle to determine its comfort and the accessibility of instruments and controls. One approach is in Figure 9.27, wherein the endostructure of *STAR III* is shown with seats and a portion of the monitoring panel. This endostructure was designed to be dismantled and later reassembled within the pressure hull. The associated panels, equipment, etc., could, therefore, be mounted to simulate the exact physical arrangements within the pressure hull. Another example is shown in Figure 9.28, which is a simulated mockup of the second *JOHNSON SEA LINK's* acrylic plastic hull.



Fig 9 24 The forward section of PC-14 with bow dome removed

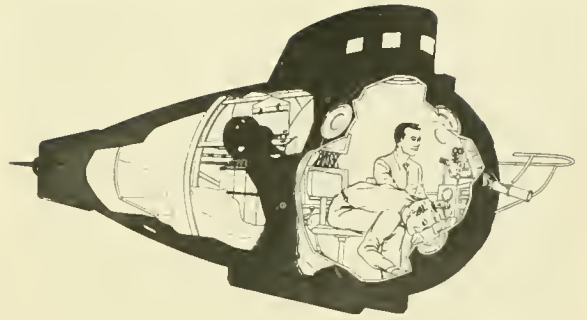

Fig. 9 26 Pilot and observer's positions as envisioned for ASHERAH. (Gen. Dyn. Corp.)

The mockup approach not only assures that the passengers will fit in the pressure hull, but that equipment will fit also. Through trial and error the final arrangements are derived. One answer not provided, however, is that of ambience—noise, for ex-



Fig 9 25 Interior view of PC-8. (Perry Sub Builders)

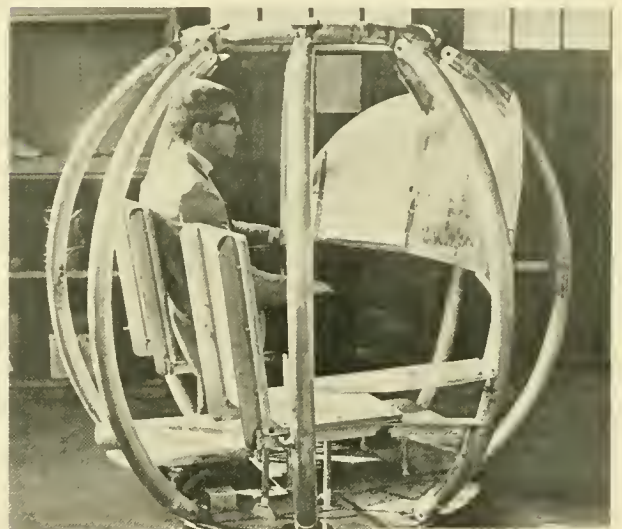

Fig 9 27 STAR III's endostructure in initial layout stage. (Gen. Dyn. Corp.)



Fig. 9 28 Mockup for second JOHNSON SEA LINK acrylic sphere.

ample—during operations and the suitability of this arrangement in terms of sustained comfort.

The only reported attempt at producing order out of this chaos is related by Blair in a paper describing some of the “manned” considerations that went into the design of the *DSRV* and the Deep Submergence Search Vehicles (*DSSV*).

Blair discusses *DSRV*'s human considerations in terms of problems peculiar to the rescue vehicle's mission of the loading, seating, restraining and disembarking of able and disabled rescuees. His discussion of the *DSSV*'s considerations, however, has application to all submersibles engaging in search, survey or inspection missions.

In order to assess the search efficiency of a four-man crew in a 9-foot 5-inch-diameter sphere, a *DSSV* mockup was constructed and

manned for a typical 34-hour mission. Arrangements were made to simulate variations in pitch, speed and altitude while a video, TV image of the ocean floor, on which two small targets (mines and telebuoys) were superimposed, was continuously presented at a central viewport.

The results of this simulation are quite interesting. To obtain a goal of 80 percent detection accuracy, a 1-hour watch at the viewport was found to be too long and 2 consecutive hours of sleep between watches were too short. A minimum volume of 400 cubic feet for four crewmen was adequate, and this allowed for inclusion of a fifth crewman who was found to be necessary in order to realize the desired detection accuracy.

Historical data presented by Blair is also germane. Based on performance studies of radar and asdic (sonar) operators in the late 1940's, a 1/2-hour watch increment was thoroughly documented (19) and showed that the percentage of targets missed increased by some 15 percent at the end of a 1/2-hour watch while the total missed targets increased by 20 percent at the end of 2 hours.

The implications of Blair's results are quite compelling: Under the best designed viewing position the observers still missed a significant portion of targets during a 1-hour watch. One can only speculate, but in the viewing position shown in Figure 9.26, it would seem that an incredibly high percentage of targets would be missed on a 6- to 8-hour dive in this position. In view of the fact that many current vehicles are performing pipeline and cable inspections, which require several hours at the viewport, such degradation in the observer's performance must be taken into account.

At this point it seems appropriate to discuss viewport location as it pertains to habitability, not only because the greatest degree of discomfort is found in submersibles' viewing arrangements, but also because direct viewing of the environment is the *raison d'être* of manned submersibles. For this reason it is difficult to separate habitability from efficiency and impossible to speak of either without discussing viewport location.

## The Continuing Saga Of The “Best View”

In the decade of the sixties the major users of submersibles were scientists: The pilots were responsible for the safety of the scientists and for maneuvering the vehicle as directed by their passengers. A great deal of the scientific work consisted of observing or sampling the bottom and/or its animal life. When the operator was required to cruise within a foot or two of the bottom or poke around in narrow submarine canyons, he wanted and got the best—and sometimes the only—view of the very things the scientist was paying to see. When the dive terminated and the scientist was debriefed or wrote his critique, invariably the complaint arose, “The pilot always gets the best view!” This placed the designer on the horns of a dilemma: If the operator is responsible for the safety of the vehicle and its occupants, then how can you find fault if he pre-empts the scientist at the viewport when maneuvering within and around potentially dangerous obstacles? On the other hand, the scientist was a paying customer; if he’s dissatisfied with playing second fiddle to the pilot, then he might take his business elsewhere. A solution, of sorts, was found by using forward-looking outboard television cameras which the pilot monitored while the scientist used the viewport. But, once again, when the going got particularly rough the scientist was obliged to yield the viewport.

The questions to be resolved, then, are: What is the best view and how do you provide it for both operator and scientist? The answers depend upon the vehicle’s tasks, its operating depth and its pressure hull dimensions.

One basic flaw in most early vehicles was that they were envisioned to be all things to all men. When they weren’t carrying scientific passengers they would carry engineers, and when they carried neither of these, the operator himself would be the data-gathering or task-conducting human element. In all cases the operator must have as good a view as possible to maneuver safely. In midwater the problem is fairly simple, by monitoring the obstacle avoidance sonar the pilot can

relinquish direct viewing to the passengers. But, near the bottom, complications arise. When moving forward, the best view is forward and down; when ascending upward along the face of a cliff, the best view is forward and upward. In a narrow canyon the best view is forward, upward, left and right.

It is apparent then, that viewports are really needed everywhere, but this is not feasible for several reasons, the most important being that the structural integrity of the pressure hull must be maintained. In Chapter 5 we saw that if a viewport penetration is cut, the material taken out has to be replaced by an equal amount of reinforcement; furthermore, there is a dimensional limit controlling the proximity of viewports to each other while still maintaining hull integrity. One solution is to make the hull thicker and larger, but the penalty is extra weight and cost. Another solution is to decrease operating depth, not always acceptable if the market shows a need for greater depth. Such trade-offs accompany every solution. Finally, the problem resolved itself by virtue of operating depth and technology. Let us start with the deeper (6,000-ft) vehicles and work our way upward.

*ALVIN*’s viewport locations (Fig. 9.29a) are fairly typical of its deep diving counterparts: One looks forward, two look obliquely left and right at a slight down angle and one looks directly down. Another, much smaller, viewport is in the hatch cover and looks directly upward. The viewing effectiveness in this arrangement depends upon the mission. If the task is to search for an object, the pilot while piloting can perform this by looking forward while the occupants look out to the side. On the other hand, if geological observations are required, then the best view is generally forward and this introduces competition between pilot and scientist. The scientist can always use the downward viewport, but he does so by sticking his head between the pilot’s feet. Fortunately, there are at least several viewing options and though they may not be considered first-rate by the scientist, *TRIESTE I*’s single viewport was abysmal by comparison.

Proceeding upward in depth takes us to the *DEEPSTAR* series and all Cousteau-de-

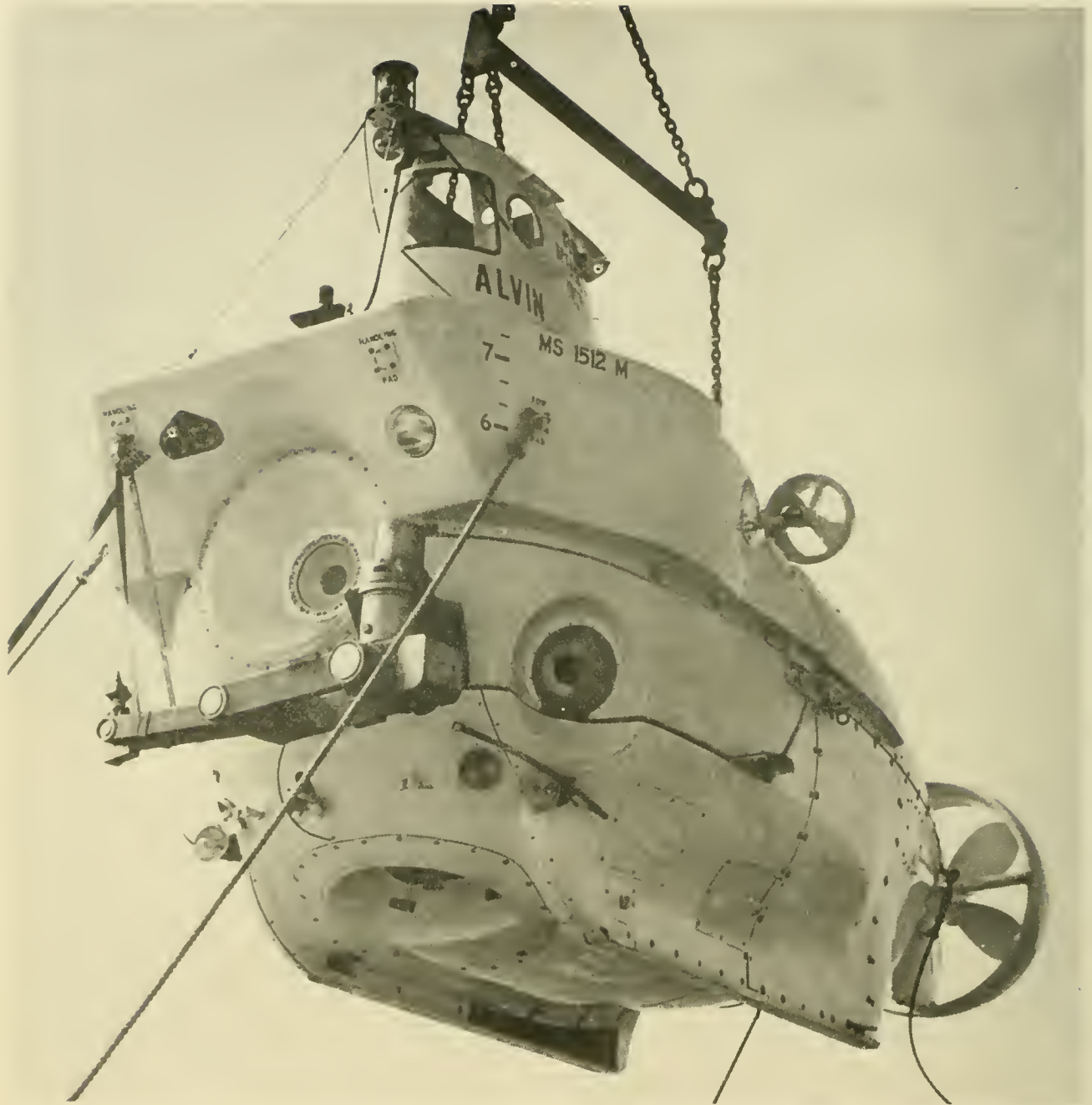

Fig 9.29 Viewport arrangements on: a) ALVIN and b) DS-4000. (WHOI; U.S. Navy)

signed vehicles of this class. Cousteau decided early that the primary design goal was photography and viewing, and he met this goal admirably. Figure 9.29b shows *DS-4000*'s bow—the two large viewports are 16 degrees from the vertical centerline and look downward 21 degrees from the horizontal.

The field of view, in water, is 74 degrees from each viewport with an overlap of some 42 degrees. This arrangement provides both the pilot and the scientist virtually the same view. The solution is an excellent one for this depth vehicle. Particularly attractive is the smaller viewport above and between the two

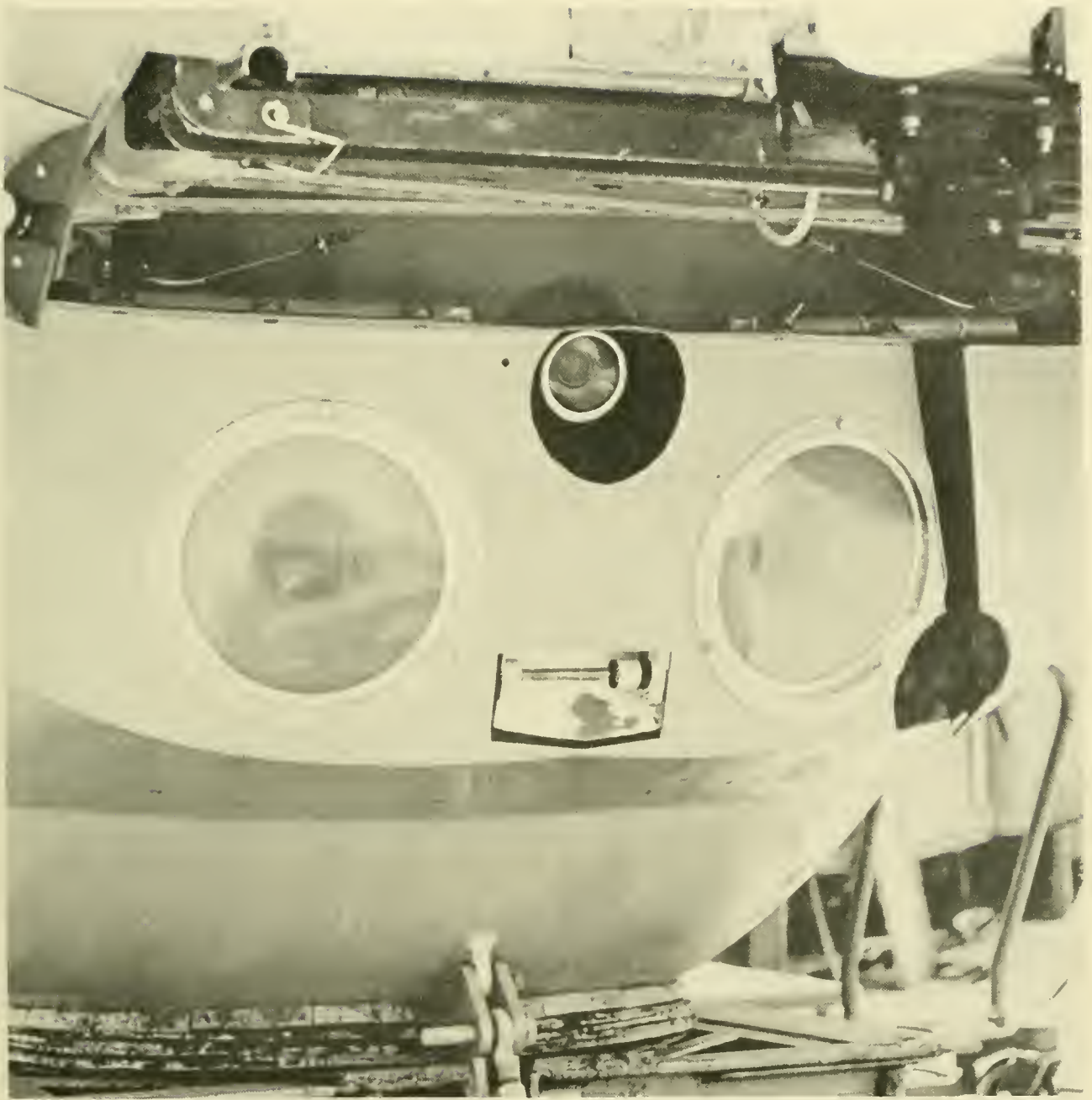

Fig 9 29 DEEPSTAR-4000.

large ones. The interior is configured to allow the mounting of a movie camera which can be operated merely by pressing a button. The camera is looking essentially at the same scene as is the observer; aiming is not a problem, and the push-button feature eliminates the difficulties inherent in handling cameras within the submersible's small confines. Provisions are made for both pilot and observer to lie down on padded, contour couches.

In shallow diving vehicles reduced ambient pressure and technological advancements allow both operator and observer a comfortable position and excellent (non-competitive) viewing. Probably here, more than in any other aspect of submersibles, a trend can be seen in vehicle design.

Initially, most shallow vehicle builders attacked the problem by incorporating as many viewports as the structural integrity could stand and the occupants could possibly

use. John Perry's *SHELF DIVER* (Fig. 9.30a) with 25 viewports is an example of this approach. Virtually any direction may be viewed with little or no reorientation of the vehicle. *BEN FRANKLIN* followed the same approach with 29 viewports, though several of these are so difficult to get to that they are, for all practical purposes, unusable.

An earlier approach to panoramic viewing by Martine's Diving Bells of San Diego incorporated plastic wrap-around viewports (Fig. 9.30b). This configuration is acceptable on the shallow-diving *SUBMANAUT* and the view from inside is quite similar to that from within an automobile. Possibly because of the then (1956) unknown characteristics of



(a)

Fig. 9.30 a) *SHELF DIVER*, b) *SUBMANAUT*, c) *NEMO* and d) *PC-8* viewing arrangements. (a&b Perry Submarine Builders; c&d U.S. Navy)



acrylic plastic other shallow diving vehicles continued to use either flat or conically-shaped viewports. Shaping the viewports into a wraparound geometry naturally costs more than merely cutting it out of a flat sheet; this also may have accounted for a reluctance to follow Martine's lead.

With the launching of *NEMO* in 1970 the

best and most comfortable view was finally provided. The spherical plastic-hulled vehicle (Fig. 9.30c) allowed both occupants a view in virtually any direction while seated comfortably in padded chairs. At this point in time acrylic plastic had undergone extensive development and testing, and its dependability and safety as a hull material was amply



(b)



c)

documented. Several subsequent vehicles followed *NEMO's* precedent: *KUMUKAHI*, *MAKAKAI* and *JOHNSON SEA LINK*.

Combining both the advantages of panoramic viewing of a sphere and the other advantages offered by a cylinder, Perry Submarine Builders developed the plastic-nosed, steel-hulled *PC-8* (Fig. 9.30d), the first of

what is now five of this type vehicle. Conventional viewports still ring the operator's conning tower, but the forward view is greatly improved over the earlier designs. Comfort, though better than in its predecessors, is still not the ultimate. Owing to the small diameter hull a 6-foot observer must remain bent forward to view. Figure 9.30d is some-



d)

what misleading in this respect because the two observers are young boys. Figure 9.24 is a more realistic portrayal with a full-sized adult in a similar-sized hull.

The 6,500-foot depth **DOWB** abandoned viewports completely and went to an optical viewing system instead. The system con-

sisted of two optical domes containing 180-degree wide-angle lens assemblies mounted top and bottom on the vehicle. Light gathered by the domes was transmitted through the hull into an optical relay tube and into a central optical assembly where it was formed into separate images for each observer. It

took some time for the observer to accustom himself to the image received, for it was, in effect, as if he were standing in the center of a radar screen and seeing everything in front, in back, above and to the sides all at once. Corrective masking shades were inserted to block out everything but the forward view which helped the newcomer to

orient himself. The seated observers each had a telescope-like object through which to view. The top dome was later moved forward on the bow as shown in Figure 9.31.

Even the "best view" in many vehicles is not 100 percent effective, because the position the scientist or pilot has to take to get to this view may be awkward and inordinately

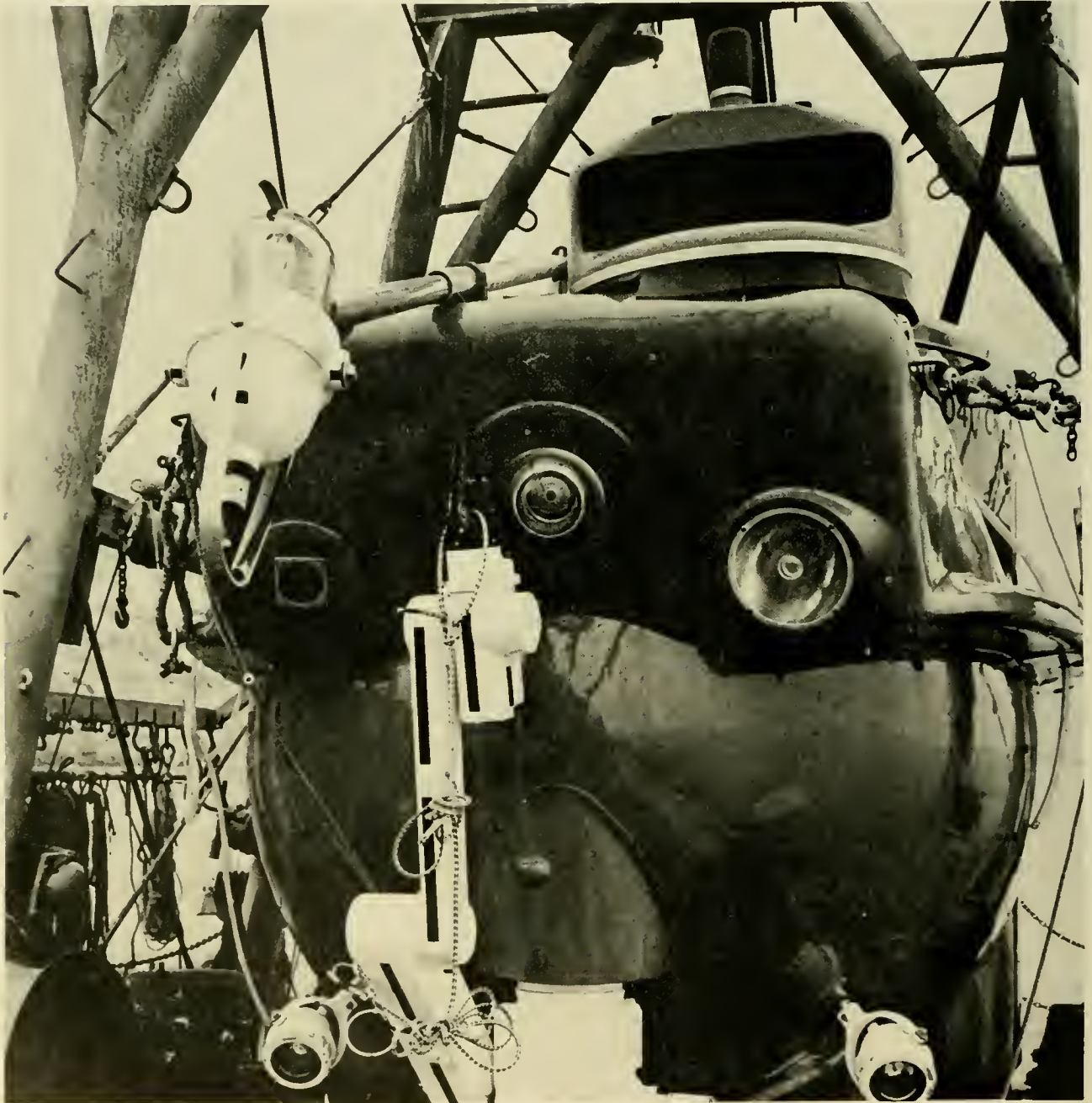

Fig 9.31 DOWB's forward-viewing optical dome is located just right of its manipulator claw (Gen. Motors.)

difficult to hold for any appreciable length of time. Examine Figure 9.32 wherein the observer is looking through the forward viewport and both his knees and elbows are supporting his weight. To record observations he must write or use a tape recorder. Writing in this position is out of the question; even managing a tape recorder microphone be-

comes a chore. One might suggest hanging the microphone in an appropriate position and leaving it on for the entire dive. This solution then requires an equal amount of time after the dive (possibly 6 to 8 hours) to transcribe the recordings; not too efficient a solution considering the many chores between dives.

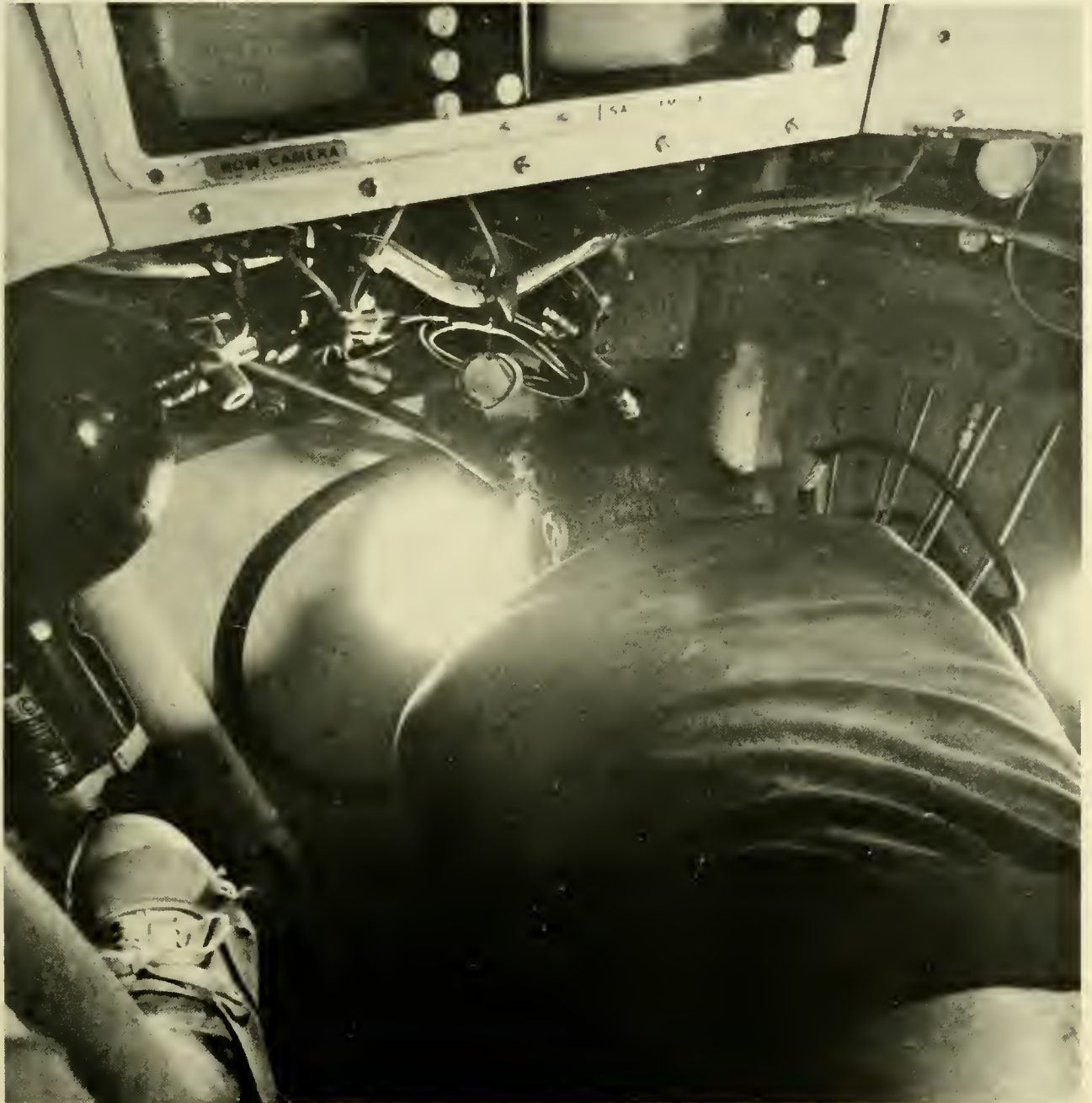

Fig. 9.32 The observer's position in *STAR III*. (U.S. Navy)

Another aspect of the viewing position in Figure 9.32 is the contact between skull and steel. In Figure 9.8 the observer is wearing a headband consisting of tape and a large piece of foam rubber. The reason for the foam rubber is not immediately obvious, but after a few minutes of viewing, it is natural for the observer to rest his forehead against the viewport rim and his face up against the plastic window. Very shortly his forehead becomes cold and painful. A number of variations of this headband are found on other vehicles. *ALVIN's* pilots, for example, wore berets which—in addition to providing a dramatic flair—served the very practical purpose of a cushion when pulled down over the forehead. Some designers rimmed the viewport with foam rubber. As long as the foam was changed frequently this solution was acceptable, but if it was not changed, it became quite rank with the cumulative sweat of the previous occupant.

The problems in viewing and comfort could be listed *ad infinitum*, but they all seem reduceable to a common denominator: Man's anatomy was an afterthought. While great pains have been taken, on the whole, to make it easy for him to operate the vehicle and survive, virtually nothing has been done to make him comfortable at the viewport. Strangely while much thought goes into the best viewport location, it appears that little at all has gone into the process of actually looking out of it. The budding designer would do himself and any prospective users a great service by simulating the position(s) he anticipates will be required to view for the same period of time he will be asking of others. Had this been done in the past, submersible designers would have discovered that pain hurts. If this seems facetious, examine the positions the observers must take in Figure 9.33 and then simulate these positions for an hour or two. It will soon become painfully apparent that someone has overestimated the human's capacity to endure.

Other than habitability in regards to viewing, other aspects of human comfort are minute by comparison. Quite naturally, a small sphere or cylinder packed with equipment and people has inherent discomforts, but these are bearable for the short periods involved. There are a few aspects, nonetheless,

that do bear on the occupant's efficiency which are present in the smaller submersibles.

## Noise

The noise level in small submersibles is generally tolerable, but at times it can interfere with communications. Pollio (20) reports that in order to understand surface telephone transmissions on *STAR III*, it was sometimes necessary to shut down all motors, the AC-DC converter and the carbon dioxide scrubber.

## Temperature Layering

While electronics operating within the pressure hull can generate needed heat, this heat may tend to stratify and create uncomfortable conditions. Pollio (*ibid.*) reports a ceiling temperature of 90°F versus a floor temperature of 65°F while operating off the Florida Keys. Redirection of the scrubber exhaust was recommended, but small fans blowing against the bottom of the hull would serve as well. In instances where high temperatures prevail, a small fan can mean the difference between a tolerable and an incredibly difficult environment. During a night dive in *PC-3B* in the Bahamas, a small circulating fan was inoperative; the ambience within was strikingly similar to a sauna bath. But, prior to and following this dive, the fan was operating and the slight breeze it created made conditions quite comfortable.

## Lighting

While illumination is generally sufficient to monitor gages, instruments, etc., it is generally insufficient for writing and, in combination with the cramped quarters, presents a strong argument for taped records.

The foregoing discussion on habitability has been, in the main, a criticism rather than a description. More unpardonable, perhaps, is that no practical solutions have been offered. However, considering the wide variety in shape and size of pressure hulls and equipment therein, there is no single across-the-board solution. The intention here is to point out to future designers that human comfort is a sorely needed improvement in manned submersibles, and ignoring this problem can seriously impair what otherwise may be an excellent design.

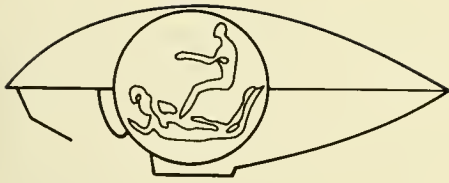

DEEPSTAR 4000  
3-MAN

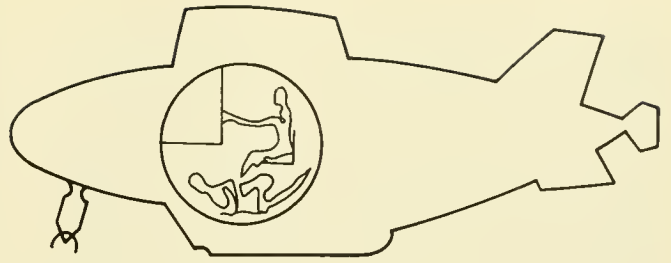

STAR III  
2-MAN

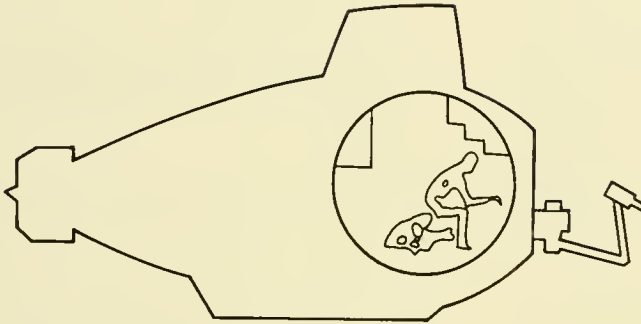

ALVIN  
3-MAN

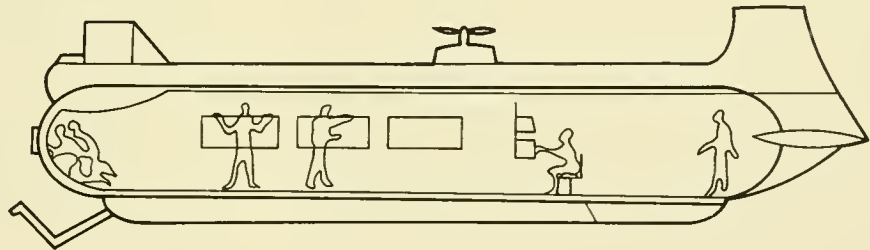

ALUMINAUT  
6-MAN

Fig. 9.33 Viewing and operating positions in four submersibles.

### Psychological Aspects

Some of the more interesting aspects of manned submersibles are the psychological effects of diving and the means used to "weed out" those unsuited for such endeavors. From time to time, consideration was given to pre-dive psychological examinations. The U.S. Navy went so far as to make this a requirement for its diving civilians and military personnel. At present, however,

the emphasis is primarily on physiological rather than psychological soundness.

From a variety of sources (mainly operators) and personal observations, the following statement can be made: If an individual has a tendency towards claustrophobia or has definite qualms about riding in a submersible, he simply does not go. This does not imply that there is no nervousness; there is, but people who embark have been either

so highly motivated or steely-nerved that their nervousness has been kept under tight control.

An interesting insight was provided in a conversation with Mr. F. D. Barnett of Perry Submarine Builders. Mr. Barnett described a particularly difficult dive in Long Island Sound during which the vehicle he was piloting was virtually at the mercy of extremely swift bottom currents. At one point in the dive he was pinned against a large boulder and had to inch his way upward along its face in order to break the current's hold and surface. Accompanying Mr. Barnett was an individual who had never dived before, but showed no signs whatsoever of nervousness or panic. Discussing the dive after surfacing, the passenger's self-control was explained when he evidenced surprise in learning that such events were not commonplace. Perhaps "Ignorance is Bliss" was the answer in many similar incidents.

The *BEN FRANKLIN* drift mission is not too revealing in this respect because all of those on board, except one, were experienced submersible divers and no stress or dangerous situations occurred during the entire drift. While there were a few incidents of minor irritability between the occupants, there was never a close approximation toward a potentially dangerous human relationship situation. This is all the more interesting because the crew was not selected for their compatibility with each other, and the background of this multi-national group (two-Swiss, one-English, three-American) was quite diverse. No doubt, the fact that this was a first-of-a-kind endeavor had much to do with the crew's behavior. If, for example, this had been the tenth or twentieth such mission for this crew, the relationship might not have been so compatible, but it wasn't, and the knowledge that one's shortcomings as an "aquonaut" might be revealed internationally on mass media had much to do with getting along.

## REFERENCES

1. Undersea Vehicle Committee, 1968 *Safety and Operational Guidelines for Undersea Vehicles*. Mar. Tech. Soc., Wash., D.C.
2. U.S. Naval Materials Command 1973 *System Certification Procedures and Criteria Manual for Deep Submergence Systems*. Navmat P-9290, Wash., D.C.
3. American Bureau of Shipping 1968 *Guide for the Classification of Manned Submersibles*. New York.
4. Eliot, F. 1967 *The design and construction of DEEPSTAR-2000*. Trans. 3rd Ann. Conf. & Exhibit. Mar. Tech. Soc., 5-7 June 1967, San Diego, Calif., p. 479-482.
5. Beving, D.V. and Duddleston, R. J. 1970 *Submersible life support components and systems*. Naval Engineers Jour., v. 82, n. 2, p. 23-31.
6. *Report of the JOHNSON-SEA-LINK Expert Review Panel to the Secretary of the Smithsonian Institution*. 21 Dec., 1973.
7. *U.S. Navy Diving Gas Manual*. 2nd Edition, NAVSHIPS 0994-003-7010, Sup. Div., June 1971.
8. Boryta and Maas 1971 *Factors influencing rate of carbon dioxide reaction with lithium hydroxide*. I&EC Process Design and Developments, v. 10, p. 489.
9. Presti, J., Wallman, H. and Petrocelli, A. 1967 *Superoxide life support system for submersibles*. Undersea Tech., June 1967, p. 20-21.
10. Ianuzzi, A. P. 1966 *The development of an integrated life support system for the deep diving research submersible DS-4000*. Trans. 2nd Ann. Mar. Tech. Soc. Conf. & Exhibit, 27-29 June 1966, p. 436-463.
11. *Bioastronautics Data Book* 1964 NASA SP-3006, Scientific and Technical Information Div., NASA, Wash., D.C., 399pp.
12. Merrifield, R. 1969 *Undersea Studies With the Deep Research Vehicle DEEPSTAR-4000*. IR 69-15, U.S. Naval Oceanographic Office, Wash., D.C., 82 pp. (unpublished manuscript)
13. Talkington, H. R. and Murphy, D. W. 1972 *Transparent Hull Submersibles and the MAKAKAI*. NURDC, Report NUC TP 23, San Diego, 26 pp.
14. Murphy, D. W., Knapp, R. H., Buecher, R. W., Beaman, G. R. and Hightower, J. D. 1970 *A Systems Description of the Transparent Hulled Submersible MAKAKAI*. NURDC, Kailua, Hawaii. (unpublished manuscript)



15. Daubin, S. C. 1967 *The Deep Ocean Work Boat (DOWB) an advanced deep submergence vehicle*. Paper No. 67-370, AIAA/SNAME Advanced Marine Vehicle Meeting, Norfolk, Va., 22 May 1967.
16. Grumman Aerospace Corp., Bethpage, N.Y. 1970 *Use of the BEN FRANKLIN Submersible as a Space Station Analog*. NASA Contract NAS 8-30172.  
Vol. I, *Summary Technical Rept.*, OSR-70-4  
Vol. II, *Psychology and Physiology*. OSR-70-5  
Vol. III, *Habitability*. OSR-70-6  
Vol. IV, *Microbiology*. OSR-70-7  
Vol. V, *Maintainability*. OSR-70-8
17. Dolan, F. J. *BEN FRANKLIN Gulf Stream Drift Mission Report*. Grumman Aerospace Corp., Rept. OSR-69-19, Bethpage, N.Y.
18. Blair, W. C. 1969 *Human factors in deep submergence vehicles*. Mar. Tech. Soc. Jour., v. 3, n. 5, p. 37-46.
19. Mackworth, N. Y. 1950 *Research on the Measurement of Human Performance*. Medical Res. Council Sp. Rept. Series 268, H.M. Stationary Office, London. (in Blair 1969)
20. Pollio, J. 1968 *Undersea Studies With the Deep Research Vehicle STAR III*. U.S. Naval Oceanographic Office, IR No. 68-103, 73 pp. (unpublished manuscript)





# 10

## OPERATIONAL EQUIPMENT, NAVIGATION, MANIPULATORS

Components of manned submersibles which make them dive and move and features which keep the occupant dry and alive and provide an outside view have been described. To these must be added equipments and devices necessary to answer such questions as: How are we doing and where are we going? The former question is answered by equipment carried on each dive which gives the operator information regarding the environment and the vehicle itself. The latter question is answered by navigational systems telling him where to go, where he is and where he's been. The last topic of this chapter deals with manipulators or mechanical arms, which provide the vehicle with manual dexterity approximating that of the human

hand and arm, though often many times stronger.

### OPERATIONAL EQUIPMENT

The devices an individual submersible carries to inform the operator of things external and internal to his craft vary widely from vehicle-to-vehicle. On a few only the vehicle's depth is supplied; on others virtually every parameter imaginable is measured and displayed. Some devices, such as underwater telephones and lights, are not data gatherers *per se*, but serve instead to assist the vehicle in operating safely and performing its mission. Others serve to inform the operator of the status of his vehicle's electric power,

deballasting air, breathing gasses, etc. Still others provide information on speed, attitude and watertight integrity. In essence, they are extensions of the operator's senses, but the variety and quality of such augmentation are a matter of operating philosophy, mission requirements and financial resources.

Operational instruments and devices are categorized by function in Table 10.1. Only a very few vehicles carry all of the instruments listed, but at least one and usually several are found on each. The majority of these instruments directly relate to diving safety and also may play a major role in rescue. Consequently, their role in this respect is dealt with in Chapter 14, and some reiteration of the following discussion may be found therein. Life support monitoring and control are discussed in the preceding chapter and are not treated further.

### Environmental Information

Cruising on or near the bottom of the ocean is a task accompanied by many unknowns. While the location and configuration of major topographic features are generally known, the location or presence of boulders, low escarpments, wrecks and junk is sparse. Therefore, all deep-diving and many shallow-diving submersibles carry devices to provide the operator with ample warning that something is coming into or near his course. It is difficult to judge underwater visibility ranges from submersibles, but 50 to 70 feet under artificial lighting is probably the best one can expect under clear-water conditions and when the lights are fixed to the vehicle.

In some shallow ocean areas where the water is extremely clear, the natural light visibility range may be two or more times as great. Consequently, devices are provided to extend the ability to "see" beyond the limit of human vision. Not only is this required for safe maneuvering, but it is also a prerequisite to the search for and location of objects on the sea floor, be they natural or man-made. Long range "viewing" is supplied by sonar or acoustic devices; short range by television and the human eye.

### Sonar:

Acoustic devices used on submersibles for navigation and search are known by several terms: Obstacle avoidance sonar, avoidance sonar or CTFM (Continuous Transmission Frequency Modulated) sonar. Regardless of its name, its function is to look ahead or to the side of the vehicle and alert the operator to the presence of "things" lying proud of or above the bottom. Two methods are in use: 1) An echo sounder arranged to point forward instead of down; and 2) a sonar capable of scanning a sector up to 360 degrees around the vehicle. Three examples will be discussed: *DS-4000's* forward-looking echo sounder, Wesmar Scanning Sonar and the Straza Continuous Transmission Frequency Modulated Sonar System. The last two are the commercial brands found most frequently on contemporary submersibles.

**Echo Sounder**—Mounted on the port side and within the fairing of *DS-4000* is a forward-looking transducer electrically coupled with

TABLE 10.1 OPERATIONAL INSTRUMENTS AND DEVICES

Environmental Information	Vehicle Control	Communications	Vehicle Status
Sonar	Depth Indicators	Radio	Electric Power
Pulsed	Altitude Indicators	Underwater Telephone	Source & Rate
CTFM	Speed Indicators	Sound-Powered Telephone	Ground Detectors
High Frequency	Distance Indicators		Compressed Air
	Pitch, Roll Indicators		Source & Rate
Visual	Heading Indicators		Life Support
Television			Source & Rate
Eyesight			Atmos. Monitors
			Leak Indicators

a strip chart recorder within the hull. The system is simply a conventional echo sounder which looks ahead instead of down. In operation an acoustic pulse is transmitted from the transducer. Conceptually, objects in the pulse's path which are capable of reflecting the pulse will do so and the echo or return pulse will be received by the transducer. The interval between signal output and return of its echo is measured electronically and the distance to the object is computed and displayed as a trace on the strip chart recorder. On 23-kHz frequency the **DS-4000** system ranges out to 5,400 feet. Relative to CTFM sonar it is inexpensive, less complex and requires less weight and internal volume. There are, however, disadvantages to this system: In order to search or scan in any direction but forward the vehicle itself must be reoriented, and no information is given as to form or shape of the object. Furthermore, the cone or beam angle is wide and, owing to beam spreading, there is no selectivity in targets. In other words, the closest reflecting object will produce the first return or trace. Nonetheless, the forward looking echo sounder served quite adequately as an object detector on **DS-4000**, and only the need for a better search capability on a different task caused its replacement.

**Scanning Sonar**—Western Marine Electronics (WESMAR) manufactures a scanning sonar used on all International Hydrodynamics-built vehicles which serves for both obstacle avoidance and search. The unit shown in Figure 10.1 is an earlier model (SS100); a later model (SS150) is aboard the Canadian Armed Forces' **SDL-1**. The SS150 has a trainable transducer within an oil-filled dome located on the bow (as in Fig. 10.1) which can be elevated from down-vertical to four degrees above the horizontal. The transducer can scan 360 degrees and a scan control feature allows the operator to scan a particular sector anywhere within the 360 degrees. A 160-kHz pulse of 0.6 millisecond is transmitted; 300 watts of power are used at long range, and 100 watts at short range.

**CTFM Sonar**—In this sonar the transmitted frequency is varied continuously in a linear sawtooth pattern and the received frequency

from an echo-producing object arrives after a short delay proportional to the range of the object (1). Being a sonic device the principles of ranging are similar to the echo sounder, but there are important exceptions. To obtain range with a conventional echo sounder one must wait until each transmitted pulse (all of the same frequency) is received before the next one can be sent. Consequently, the number of "looks" per unit time is governed by distance to the object. With continuous scanning at varying frequencies each reflected pulse is distinctly recognizable, and therefore, the number of looks over a given time period can be and is much greater. To this is the added capability to train or rotate the transmitting/receiving element through 360 degrees laterally about the vehicle and a narrow beam pattern which is highly directional. These last two features can be incorporated into conventional echo sounders (the WESMAR for example), but the use of varying and continuous frequencies at high angular scan rates is unique to the CTFM. The range information for CTFM is presented both visually on a cathode ray tube (CRT) and aurally—the latter overriding as an additional means of determining the echo characteristics. Frequencies of CTFM's can be low (20 kHz) or high (1,000 kHz), but are generally in the 70- to 90-kHz range.

The predominant CTFM found on American submersibles is manufactured by Straza Industries, whose model 500 CTFM is used on the U.S. Navy's **SEA CLIFF** and **TURTLE**. It operates on a frequency of 72 to 87 kHz, scans at a rate of 25 degrees per second and has a range of 10 to 1,500 yards. The details of this system are presented in Table 10.2, not as an endorsement of this particular CTFM, but to provide an idea of CTFM's characteristics and capabilities. An earlier Straza CTFM (model SM502A) is shown aboard **ALUMINAUT** in Figure 10.2.

The Straza model 500 also has the ability to receive and indicate bearing to marker signals at 37 kHz, and in another mode can trigger a sonar transducer to respond in the 40- to 50-kHz frequency band. This latter feature indicates range and bearing to the transponder(s) and may be used for undersea navigation.

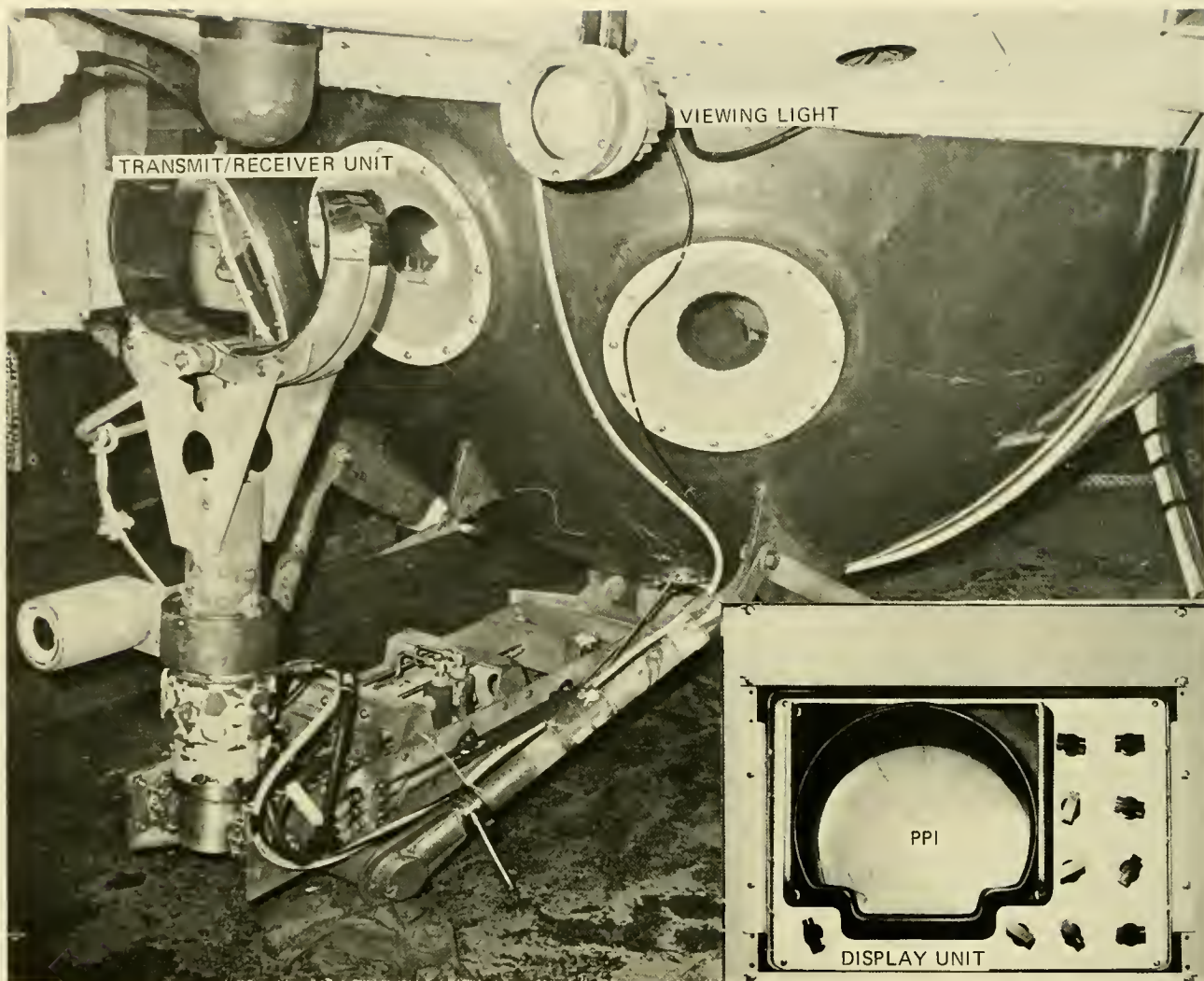

Fig. 10.1 Western Marine Electronics' (WESMAR) Model SS100 scanning sonar aboard *PISCES III*. (HYCO)

**Acoustic Imaging** —Under certain conditions underwater visibility by optical means is impossible owing to turbid conditions (suspended material). For such contingencies acoustic devices have been developed which can insonify objects and present an image on a CRT quite analogous to optical viewing. Investigators at Lockheed (7) described a system developed for the *DSRV* which operates at a frequency of 2.5 megahertz (MHz) and affords a real-time, high-resolution optical display of underwater objects or activities at ranges up to 30 feet. The *DSRV*'s would employ acoustic imaging for mating with or clearing debris from around the hatch of a stricken submarine when optical

devices were ineffective. However, no results of the system's use in the field are available.

**Visual:**

For short range and detailed knowledge of the external environment the human eye is the most perceptive and trustworthy instrument aboard a submersible. The effectiveness of the eye is governed by ambient light level, turbidity and, in the case of artificial lighting, light location. On some vehicles direct viewing, *i.e.*, through viewports, is augmented by television. Both direct (viewports) and indirect (TV) viewing have their advantages and disadvantages, and the factor bearing most heavily on either system's ef-

TABLE 10.2 CHARACTERISTICS OF THE STRAZA (MODEL 500) CTFM SONAR

Range	10 to 1,500 yards	System Bandwidth	2,500 cycles with slope response compensation for transmission losses
Scan Rate	25 degrees per second	Output (Audio)	500 to 3,000 cycles
Operating Frequencies		Output (Visual)	PPI (plot presentation indicator) display 7-in. CRT with P7 phosphor
Sonar	87 to 72 kc	Power Requirements	115 ( $\pm 15$ ) volts, 60-cycle $\pm 10$ percent, 1 amp; 27 ( $\pm 3$ ) volts, 3 amps
Transponder Interrogation	87 to 72 kc	Operating Depth	
Transponder Receiving	55 to 40 kc	(Outboard Components)	20,000 feet
Marker Receiving	37 kc	Weights	
Transducer Beam Patterns		Display Unit	30 lb
Projector (horizontal)	60 degrees	Sonar Unit	32 lb
Projector (vertical)	15 degrees	Analyzer Unit	40 lb
Hydrophone (horizontal)	2 degrees	Training Mechanism	45 lb in air, 27 lb in water
Hydrophone (vertical)	15 degrees	Transducer Assembly	47 lb in air, 35 lb in water
Projector Source Level	+90 db re 1 microbar at one yard	Test Transducer (Oil Filled)	7/8 lb in air, 5/8 lb in water
Receiving Sensitivity	-40 db re 1 microbar		
Target Detection			
Zero db Target	500 yards		
+25 db Target	1,000 yards		
+50 db Target	1,500 yards		
Frequency Analyzer	40 channels, 50-cycles filter, 500 to 2,500-cycles band with envelope detectors		

fectiveness is lighting. The effectiveness of direct viewing is also governed by viewport location, which was discussed in the preceding chapter. Assuming 20/20 vision of all observers, there is little more that can be discussed other than artificial light arrangements and characteristics with regards to direct viewing. The topics of this section, therefore, are limited to lighting as it affects visual observations and to television as an adjunct to direct viewing.

**Lighting** —The varieties, characteristics and manufacturers of underwater light sources on present submersibles would be all but impossible to list because they can and do change rapidly. In some instances the lights are “homemade” modifications of automobile lights. The *SEA OTTER* operators (Fig. 10.3), for example, took British “Rally Lights” manufactured by CBIE and pressure-com-

pensated their housings with air using a scuba-type regulator. But for the most part underwater lights are purchased from one or several of the many companies supplying this area. (The 1973 *Undersea Technology Handbook Directory*, reference (2), lists 60 suppliers of marine lights and beacons in the U.S., though it does not distinguish which of these are of the underwater variety.)

It is difficult to discuss underwater lighting without first discussing light transmission in the sea. Space, however, limits the discussion herein merely to a brief introduction. Virtually any introductory book on oceanography or undersea photography will provide the reader with an adequate background. For a complete and technically thorough treatment of the principles involved, the work of Tyler and Preisendorfer (3) is recommended.

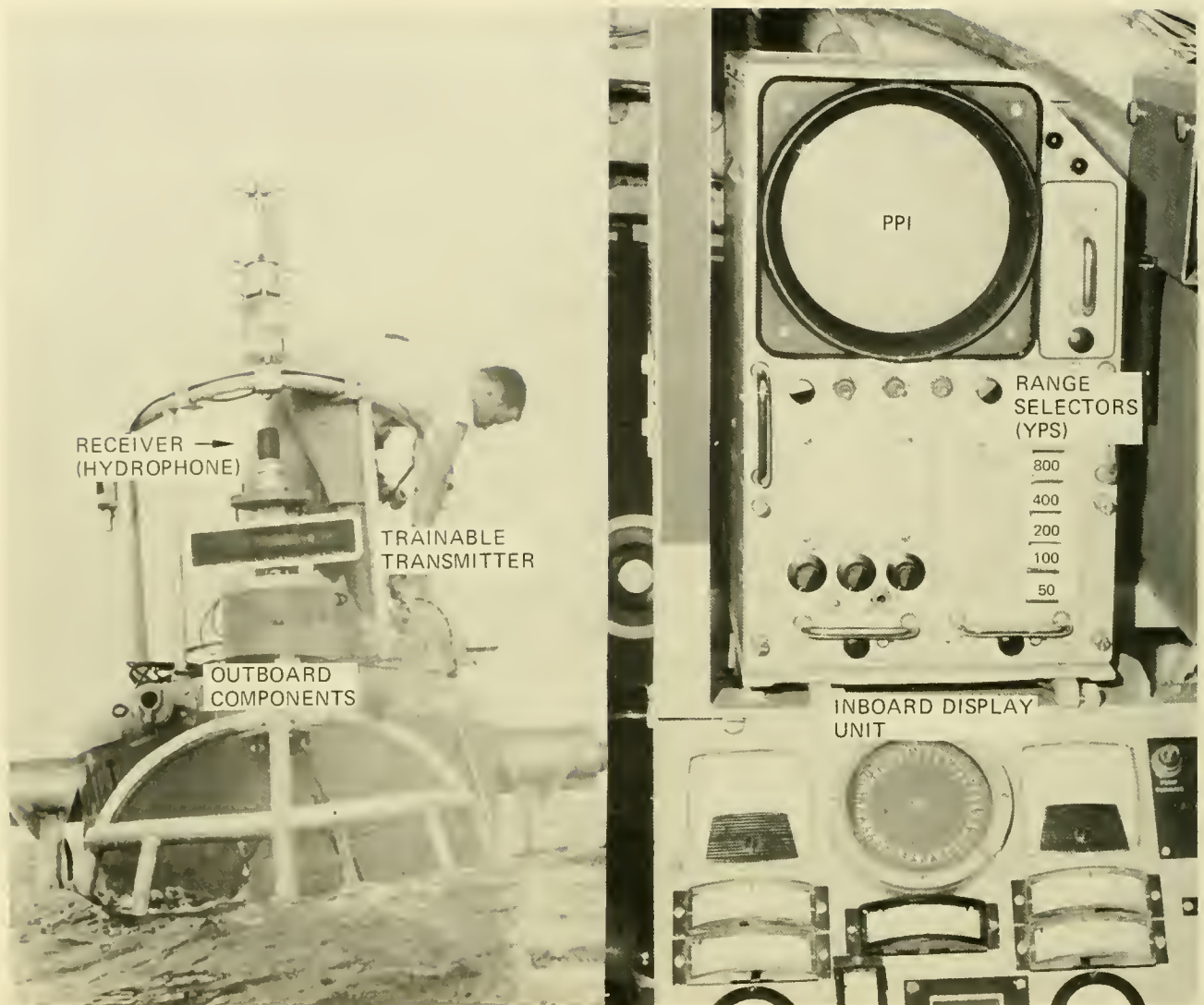

Fig 10.2 STRAZA Model SM502A CTFM sonar components aboard ALUMINAUT. (U.S. Navy)

Compared to passage in air, light passing through water is rapidly attenuated. This is the result of: Absorption and scattering due to the water itself, materials dissolved in the water and plankton and detritus living and suspended within the water. The absorption of light varies with the wavelength.\* Scattering is practically independent of wavelength since the particle size is usually much larger than wavelengths in the visible light spectrum. Larson and Rixton (4) constructed a typical curve of percent transmission through 20 feet of clear ocean water versus the wavelength. Their graph is reprinted in

Figure 10.4 and shows the maximum wavelength transmission (78%) as being at about 5,000 Angstroms—the green band. This particular characteristic (absorption as a function of wavelength) is a major factor governing the choice of the most effective underwater lights for viewing.

While there are many varieties of lights for subsmersibles, three types are in general use:

Quartz Iodine—an incandescent light source using a tungsten filament. The “iodine cycle” precludes deposition of evaporated tungsten on the inside of the bulb and subsequent blackening.





Fig. 10.3 Viewing lights, camera and strobe light, and homing antennae clustered on the brow of SEA OTTER. (Arctic Marine)

**Mercury Vapor**—A gas discharge light that produces light by passing a current through mercury vapor under pressure.

**Thallium Iodide**—Similar to the mercury vapor light, but with the addition of thallium to the mercury in the arc tube to increase lumen efficiency and produce a different spectral output.

Incandescent lights radiate throughout

the visible portion of the spectrum and concentrate most of their energy in the red area. The mercury principal line is at approximately 4,400 Angstroms (blue); the thallium line is at approximately 5,350 Angstroms (green). Referring again to Figure 10.4, it is seen that the gas discharge lights produce a color spectrum least attenuated by absorption.

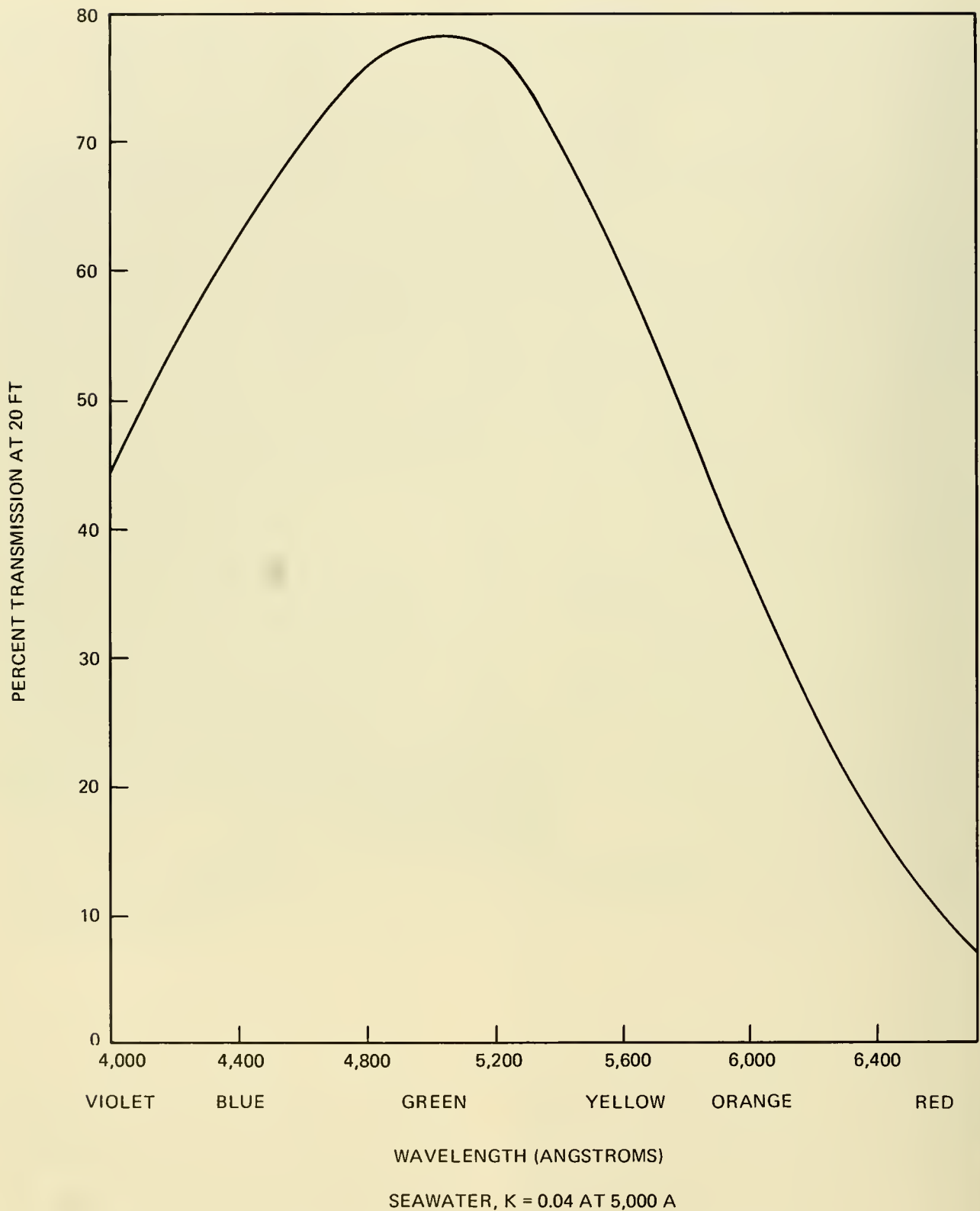

Fig. 10.4 Light transmission as a function of wavelength through 20 feet of clear seawater. The constant  $k$  is the coefficient of absorption for seawater. [From Ref. (4)]

Trying to assess or judge which of these lights is better than the other is difficult, because, like submersibles themselves, each one has assets that make it desirable for certain tasks and undesirable for others. Consequently, the most legitimate and realistic approach is to present characteristics of each and let the user decide which serves his purpose best.

C. L. Strickland and R. L. Hittleman of Dillingham Corp. (5) presented the results of their tests which compared the above three lights in respect to light output, sensitivity to input power variations, attenuation versus distance, compatibility to television and color rendition. The test results clearly define the advantages and disadvantages of each type and simplify the selection of light types for particular tasks.

For these tests each light or lamp was in an identical housing, envelope and reflector configuration and operated at 250 watts (except for the color rendition tests when both 250 and 1,000 watts were used). The results are highlighted below.

**Light output** —(lumen efficiency)

quartz iodide	18 lumens per watt
mercury vapor	40 lumens per watt
thallium iodide	75 lumens per watt

At 120 volts the measured output showed the thallium iodide to be twice that of mercury vapor and six times that of the quartz iodide. Varying the input voltage showed the mercury vapor and thallium lights to drop to 85 percent of the 120-volt output; quartz iodide has an output of less than 45 percent of its output at 120 volts.

**Attenuation** —The centerbeam candlepower (cp) of each light was measured in clear seawater at distances of 1, 2, 3 and 3.5 meters from the source. The data at 2 meters are as follows:

	Output (cp)	cp at 2m	Attenuation of initial output (2m)
quartz iodide	1,100	110	90%
mercury vapor	(not given)	(not given)	80%
thallium iodide	5,500	1,500	72%

**Contrast Level Versus Distance** —An experiment was conducted using gray scale targets at 2, 4, 6 and 8 meters from a television camera to examine where the various lights fell in rela-

tionship to the peak of the video response curve. The thallium iodide provided much better contrast than the other two, especially at 4, 6 and 8 meters. Only a slight difference was measured between the mercury vapor and quartz iodide lamps. This was explained on the basis of a camera feature which automatically compensates for the lower light output of the quartz iodide. It was theorized that if the targets were farther apart or the water more turbid, the gas discharge lamps would have more clearly demonstrated their superior penetration. In this respect Figure 10.5 compares both the spectral sensitivity of both the human eye and a typical black and white TV camera. The curves for both eye and camera peak at about 5,500 Angstroms which is almost identical to that of thallium iodide's principal line spectrum (5,350 A).

**Color Rendition** —At 250 watts for each lamp the following results were obtained by comparing photographs of a spectral color chart at the varying distances:

1 meter: **quartz iodide** showed strong green and blue attenuation and the violet appeared almost red. **mercury vapor** showed poor color rendition except in the blue-green region.

**thallium iodide** showed some red output, blue and violet; green is predominant.

2 meters: **quartz iodide** (1,000 watts) provided good color rendition at this distance, 2.5 meters seemed to be the limit for the 1,000-watt light.

**mercury vapor** showed greens and blues, otherwise the light had very little color rendition.

**thallium iodide** showed yellow and green, other colors were non-existent.

Strickland and Hittleman conclude that each light has its distinct advantages for certain applications, but predict that thallium iodide should become the primary underwater light source in the near future.

Subsequent to the above study, A. L. Waltz (6) of the Naval Undersea Research and Development Center conducted an investiga-

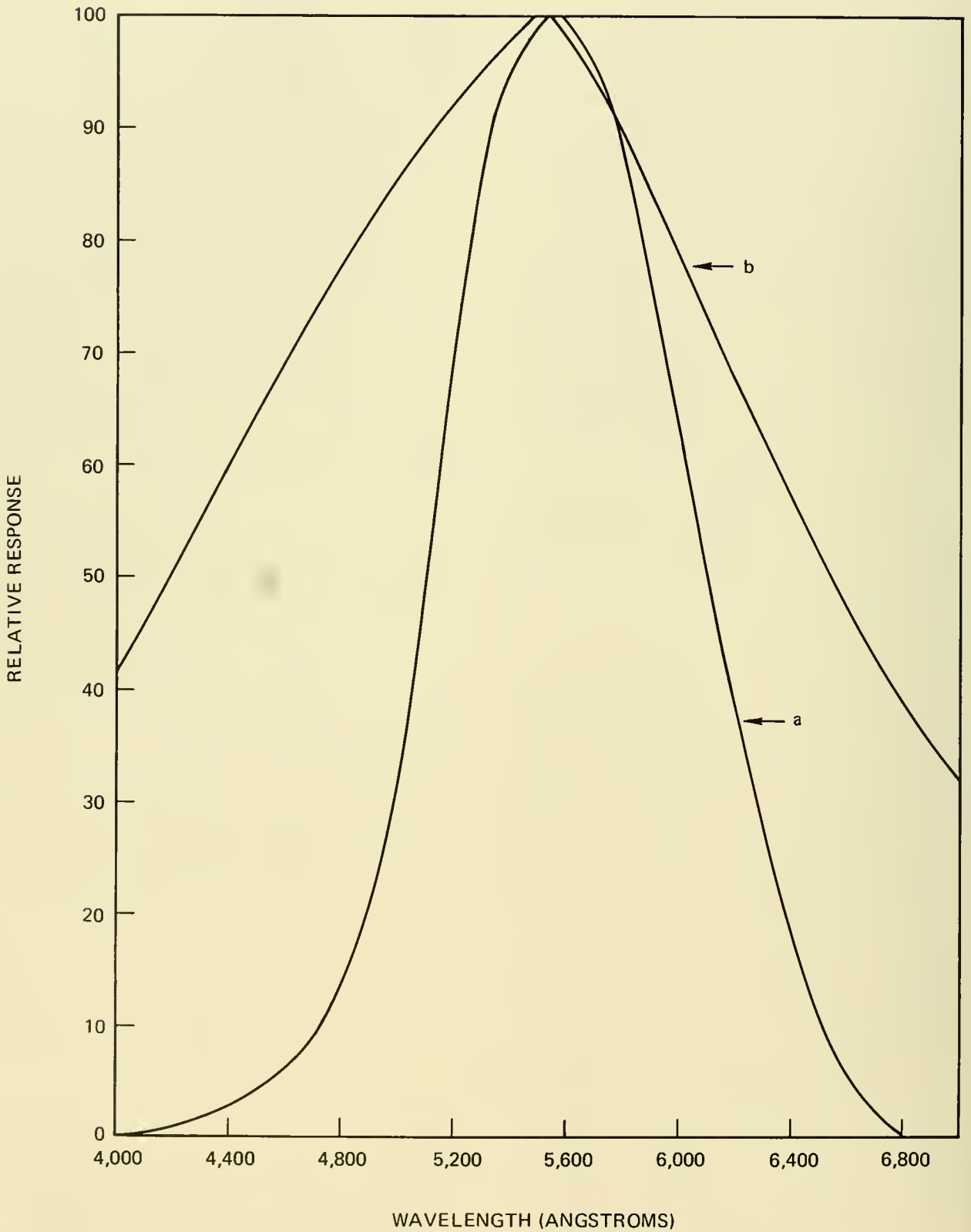

Fig. 10.5 A comparison of the spectral sensitivity of the human eye (curve a) and a typical black and white television tube (curve b). [From Ref. (5)]

tion into ways of improving reliability and efficiency of underwater lights. Table 10.3 was taken from Waltz's report and it summarizes the characteristics and pro's and con's of the commercial light types discussed above as well as others.

On the whole, the NURDC study confirmed the results of Strickland and Hittleman, adding that there was a lack of demonstrated reliability in all existing light systems. Light failures occurred both during operations and during design assurance testing. The primary type of failure during operation was stated to be leakage of water into the glass envelope housing which usually caused a short circuit in the power supply lines.

Analyzing the mercury vapor light failures on the *DSRV*, Waltz noted that leakage was not the problem, but, instead, the fluctuating power supply from the *DSRV's* main batter-

ies was a chief culprit. The mercury lights are designed for AC operation, hence, the power must be converted from DC to AC and then current limited, this is accomplished within a ballast unit. The ballast units did not regulate the varying voltage input (90 to 140 VDC) adequately and resulted in the light being driven at a greater power level than its nominal rating at high inputs (which reduced its lifetime) or driven at a lower than rated voltage which decreased its luminous efficiency. The prime *DSRV* ballast unit deficiency was in the electrical power conversion efficiency which was as low as 55 percent. This manifested itself in the form of heat which caused failure of several units. Filling the ballast units with a dielectric oil to improve cooling efficiency and replacing some electric components solved the problem somewhat.

Another serious deficiency with the mer-

TABLE 10.3 SUMMARY OF LIGHT SOURCE CHARACTERISTICS [FROM REF. (6)]

Light Type	Optical Characteristic	Power Source Requirements	Advantages	Deficiencies
Mercury vapor arc	Lines in violet, blue, green, and yellow, deficient elsewhere.	Current limited supply, regulated power input	Relatively high efficiency ( $\cong 45-50$ lumens/watt)	Relatively long start time ( $\cong 6$ minutes) and restart time ( $\cong 10$ minutes). Poor color rendition
Thallium iodide-doped mercury vapor arc	Green line of thallium dominates the visible output, mercury lines are suppressed somewhat	Current limited supply, regulated power input	Very high efficiency source of green light ( $\cong 85-90$ lumens/watt)	Relatively long start time ( $\cong 5$ minutes) and restart time ( $\cong 10$ minutes)
Dysprosium iodide-thallium iodide-doped mercury vapor arc	Many lines and background level radiation spread thruout the visible, with the green thallium line being the dominant line	Current limited supply regulated power input	High efficiency source of visible light ( $\cong 80$ lumens/watt) with relatively good color rendition	Relatively long start time ( $\cong 4$ minutes) and restart time ( $\cong 10$ minutes)
Incandescent tungsten filament	Continuous output throughout the visible spectrum, increasing from the blue to the red end of the spectrum	Regulated power input	Fast start time ( $< 1$ second) and good color rendition	Relatively low efficiency ( $\cong 24$ lumens/watt)
Xenon arc	Continuous output throughout the visible spectrum	Current limited supply, regulated power input	Fast start time (80% output instantaneously) and immediate restart, excellent color rendition	Relatively low efficiency ( $\cong 22$ lumens/watt), requires a high voltage pulse to start

cury vapor lamps was the relatively long warmup time required to obtain peak output. With tungsten lamps warmup time is about 0.5 second; with mercury vapor the time could be as long as 13 minutes in cold water. The report concluded with a preliminary design for lights and ballast units which, in Waltz's opinion, would correct the deficien-

cies as he saw them. It should be noted that this study was performed in 1970. By now it is safe to assume that several lighting problems are either solved or much reduced, considering the greater experience accumulated and advances in technology over this 5-year period. Figure 10.6 shows a variety of underwater lights for use on submersibles.

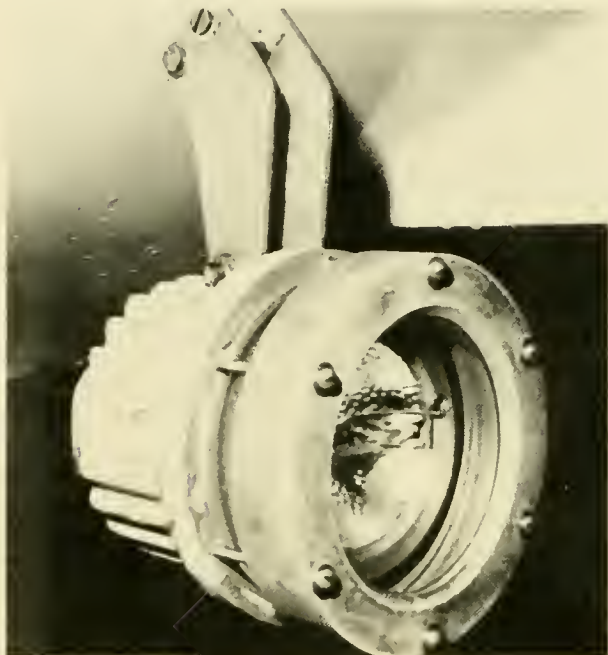

Fig. 10.6 Various underwater lights on submersibles: a. Birns & Sawyer, b. Hydro Products, c. EG&G International, and d. Ikelites pressure compensated by air.

b)



c)

d)

Another aspect of lighting which bears heavily on viewing range concerns the lights' position on the submersible. Mentioned above were the effects of light scattering by particulate matter (organic and inorganic) in the water column. Surprisingly, even the clearest waters have considerable amounts of such material which scatters and reflects light, thus creating viewing conditions quite similar to those of an automobile's headlights in a fog. (This suspended material is generally called "snow" by submersible operators, and it is a real-time indicator of whether the submersible is descending or ascending.) The majority of submersibles have their lights attached directly to the

fairing or in the immediate vicinity of the viewport (Fig. 10.1). To illuminate an object at some distance from the submersible the light must travel a two-way path (out and back) and is subject to scattering in both directions. The result is to limit both the range of viewing and the intensity of light returning to the observer. Another problem is created with this arrangement when photographing through the viewport, because generally, but not always, the lights are aimed to concentrate on one spot forward and downward in front of the submersible; this creates a "hot spot" which overexposes one portion of the photograph and underexposes others (Fig. 10.7).



Fig. 10.7 A photograph of the sea floor taken from ALVIN. Note the overexposed region or "hot spot" and underexposed regions at the extremities. Subsequent lighting rearrangements provided more uniform exposure. (U.S. Navy)

To eliminate the "hot spot" and reduce scattering many vehicles mount their lights on a boom (Fig. 10.8) or as far out on the brow as possible. In this manner the light has less distance to travel which reduces the amount of scatterers it must confront and permits the lamps to be oriented to provide more uniform lighting over the area of interest.

**Television** —The television camera has rapidly become an invaluable tool in virtually all areas of ocean exploration and exploitation. In the early days of deep submergence it played a minor role. Because it was large, it took up valuable space in the pressure hull. It also consumed a significant portion of the limited power, and interfacing it with other electronics was complex. In addition to these problems, relative to the human eye it lacked range, color and depth perception. Subsequent technological advancements have largely eliminated the volume and interfac-

ing problems, and the latest television cameras now provide range of view and details which may exceed the human eye at the viewport.

The role of TV is quite varied, several submersibles mount a camera on the sail and use it for maneuvering on the surface. In this application, it is not necessary to open the hatch to maneuver, which might well be impossible in certain sea states and, when the vehicle's controls are not portable, might be the only alternative to maneuvering blindly.

The most general application, however, is as an adjunct to the viewport wherein it allows the operator to maneuver while the observer occupies the viewports. In some instances it is the only means of viewing areas around the vehicle and vehicle components where there is no direct view available. On *BEN FRANKLIN* a television camera was mounted on an external pan and tilt mechanism with two 70 mm cameras and it served as an aiming device for the cameras. One of its increasing roles is that of recording bottom features or other objects to provide a permanent video tape record for detailed post-dive analysis.

A variety of TV cameras, monitors and recorders is commercially available (e.g., Hydro Products, General Video Corp., Edo Western, Ball Brothers Research, Cohu Electronics, Thomson-CSF) which can operate to any ocean depth. One commercial camera, the Hydro Products TC150, is shown in Figure 10.9. It incorporates automatic light compensation, remote focusing from 3 inches to infinity and is rated to 10,000 feet deep.

One of the more important technological developments enhancing the role of underwater television is the development of a low light level television camera (LLTV) which extended the viewing distance and reduced illumination requirements. Mr. Arthur Vigil of Hydro Products traced the development of the LLTV for underwater applications and compares its performance advantages against other available television tubes (Vidicon, Image Orthicon, Plumbicon, Silicon Target Vidicon). Table 10.4 is taken from Vigil's paper (8) and compares a low light level tube (RCA's Silicon Intensifier Target (SIT) tube) against a conventional Vidicon



Fig. 10.8 Crewman of *ALUMINAUT* in the process of lowering a light boom containing four EG&G incandescent lights. (U.S. Navy)



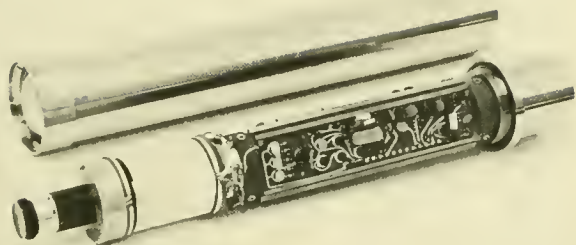

Fig 10.9 Hydro Products' Model TC150 underwater television camera (Hydro Products)

tube. It is interesting to note the peak of spectral response of the SIT tube which is at 4,350 Angstroms and somewhat different for the peak response of a "typical" television tube shown in Figure 10.5.

## Vehicle Control

### Depth Indicators:

For obvious reasons, every submersible has a depth measuring device, and quite a few carry more than one. Virtually all rely primarily on pressure sensing depth gages, and a number also use an upward-looking

echo sounder to measure their depth by ping-ing off the surface. Once again, the variety of manufacturers of depth measuring and indicating devices is numerous, and in the submersible field no one brand is preferred over another. Consequently, an overview of the principles involved in submersible depth measuring devices serves better than a list of trade names. This approach is taken, and a few examples of systems employed in contemporary vehicles are described.

**Expandable Metallic Element Gages** —The most common and widely used design principle in depth measuring devices is found in the Bourdon tube. The Bourdon tube employs a curved or twisted metallic tube flattened in cross section as the sensing element. One end of the tube is sealed and pressure is applied to the opposite, open end. At the onset of applied pressure the tube becomes more nearly circular in cross section and tends to straighten. The movement of the sealed or free end is used to measure the external pressure. The most common "C" tube arrangement is shown in Figure 10.10. Other tube configurations (spiral and helical) are employed when greater tip motion is desired. Bourdon tubes can be used for small pressure measurements (0–10 psig) or large measurements (0–100,000 psig) with accuracies from 0.1 to 2.0 percent of full scale. These gages are simple, rugged, inexpensive and are used on many vehicles. The means of

TABLE 10.4 COMPARATIVE DATA ON VIDICON AND SIT CAMERA TUBES [FROM REF. (8)]

	7262A Vidicon	4804/P2 SIT Tube
Average "Gamma" of Transfer Characteristic	0.65	1.0
Lag (% of initial signal current 1/20 second after illumination is removed)	23%	7%
Limiting Resolution (TV lines) at Center of Picture	750	700
Dark Current at 0.1 Footcandle	0.1 $\mu$ A	.007 $\mu$ A
Sensitivity (Ref. Figure 5)	0.2 $\mu$ A/fc	350 $\mu$ A/fc
Typical Gain Ratio Adjustment:		
Target Voltage (5 to 50 V)	100	—
Photocathode Voltage (–2.5 to –9 kV)	—	400
Peak of Spectral Response (angstroms)	5,500	4,350

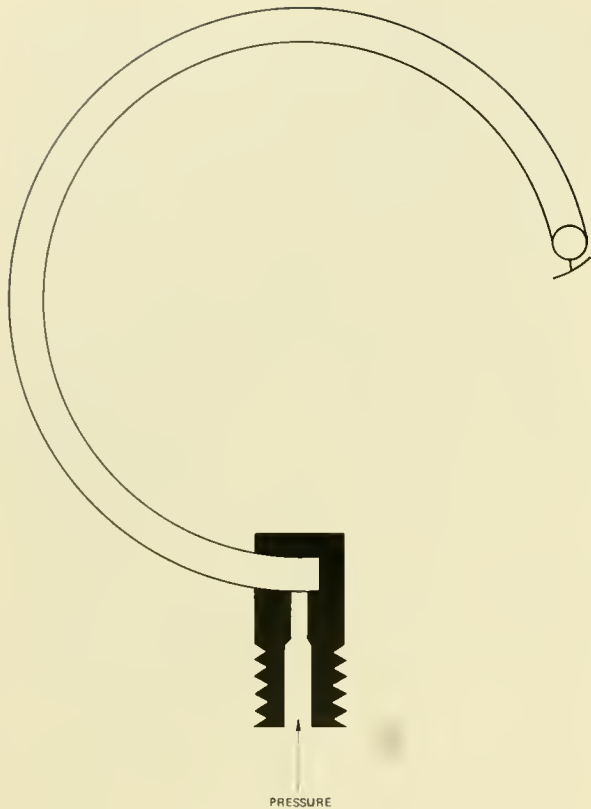

Fig. 10.10 Bourdon tube.

transmitting pressure through the hull to the sensing element varies. In one instance (*BEN FRANKLIN*) a soft reservoir external to the hull was filled with mineral oil which transmitted pressure changes by thru-hull hydraulic lines directly to the sensing element inside the hull.

**Resistance Type Pressure Transducers** —These instruments are composed of a pressure-sensing element, such as the Bourdon tube, a device to convert its tip motion to an electrical parameter and a device to indicate or record pressure changes. A major advantage to this system is that there is no free or open end leading directly to the sea, because the depth indicating signal is passed electrically through the hull. The most common form of pressure transducer is a contact coupled to the sealed end of the Bourdon tube which slides along a continuous resistor. With a resistor of constant cross section, the change in resistance will be proportional to the movement of the contact.

The pressure transducer shown in Figure 10.11 is a bellows type in which the pressure

from the bellows is exerted against a precisely designed spring which reacts and converts the pressure to a linear motion via the plate (moving contact) between it and the bellows. The plate has a contact which wipes the surface of the resistor and, if a constant AC or DC potential is held across the resistor, the measured voltage (at the voltmeter) is a precise measure of the pressure.

*DS-4000* uses this principle as one means of sensing depth, but a Bourdon tube is used instead of a bellows. The unit (Hydro Products Model 404) is in a pressure-resistant aluminum housing, the Bourdon tube is oil-filled, and a rubber diaphragm separates the pressure transducer from the external environment to provide corrosion protection. A potentiometer is contained in the sensor and receives excitation voltage from a monitor unit in the pressure hull. The output is voltage proportional to the external sensor. The monitor (Hydro Products 402) indicates depth to 1,600 meters at 20-meter increments and is powered by a mercury battery that is good for 200 hours. Maximum visual meter indication error is 2 percent of full scale.

**Strain Gage Pressure Transducers** —Chapter 5 described the role of strain gages in providing data to compare calculated against measured hull strength. The same unit, by virtue of its change in resistance as a function of hull distortion from ambient pressure, can also provide accurate depth measurements. The U.S. Navy's *SEA CLIFF* and *TURTLE* employ three independent strain gage (Wheatstone) bridges bonded to the interior of the pressure sphere which are selected individually to supply an electrical depth

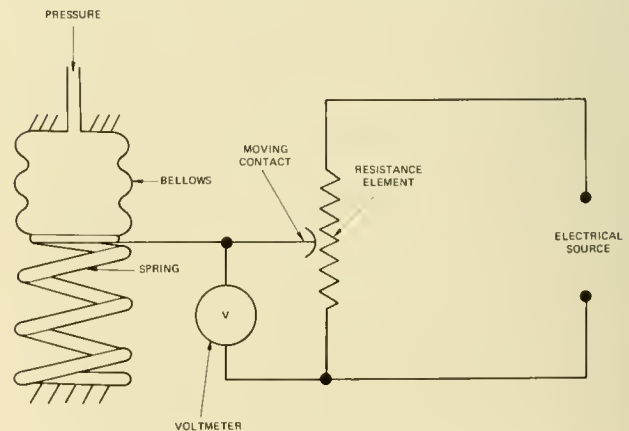

Fig. 10.11 Resistive pressure transducer.

signal to an indicator unit. These vehicles use a pressure transducer as the primary depth sensor, and the strain gages are used as both a backup and a check on the pressure transducer. If a critical difference develops between the strain gages and the transducer a "difference" indicator lights to alert the operator. The pressure transducer is manufactured by Electric Boat/General Dynamics and has a range to 7,500 feet with an accuracy of 0.45 percent of full scale. Its readings are displayed on a nixie tube (numerical indicating), but can be switched to a dial indicator if the nixie display fails. The transducer output is also differentiated to an ascent-descent rate amplifier and displayed on a meter in the depth indicator unit.

Measurement of vehicle depth (or, conversely, of height off of the bottom) as a function of water pressure is accompanied by a host of variables which work to reduce the measurement accuracy. Whether deployed in air or water, there are the inherent inaccuracies encountered in the instruments themselves, their design and materials of construction. Their use in the ocean environment introduces dynamic conditions not generally found ashore in land-based applications. Hydrostatic pressure at a given depth, for example, is affected by gravity, water density (which varies with temperature, salinity and compressibility—the last being a factor mainly at the greater depths) and atmospheric pressure variations.

Since atmospheric pressure seldom varies by more than 1 inch of mercury except under extreme storm conditions, its effect on depth readings is not likely to exceed 1 foot. Below depths of 100 to 200 feet this variation is lost in instrument error. The effects of waves are not felt below a depth of about two-thirds of the significant wavelength—the effective hydrostatic pressure being averaged to mean sea level below that depth. The error caused by variations in density is random but in most submersible diving situations is small in comparison to the gravity variation. Gravity variations produce measurable humps or depressions in local sea level. These may be static (permanent), the result of local density anomalies in the solid-earth structure, or they may be cyclical, the result of tidal influences. In the open ocean, however, even

these are measured in centimeters, not meters.

Nevertheless, density variations are a consideration, and Woods Hole's N. P. Fofonoff has constructed a standard specific volume profile (the reciprocal of density) which provides corrections by geographic location at various depths within the world's oceans. Contrary to popular belief, water is compressible—though much less so than most other liquids. At the tremendous pressures encountered in the deep ocean, compressibility (which increases local water density) can produce a considerable error in depth by any type of pressure transducer.

In addition to gravity, ocean currents—whether driven by the wind or Coriolis force—can and do produce variations in local sea level over considerable areas. Although this does not affect the depth sensor's measurement of how deep the submersible is beneath the local sea surface, unless provision is made for this anomaly, calculations of how far the vehicle is above the bottom will be in error. Again, considering basic instrument error and all the other factors which affect depth readings, these differences (particularly at the greater submersible depths) are not significant—except under the most exacting physical oceanographic requirements, as in geostrophic flow and dynamic sea-surface topography research, for example.

From a safety standpoint the errors introduced from the above factors do not prohibit use of pressure/depth gages in submersibles, because the errors are small in comparison to the general safety factor of 1.5 built into pressure-resistant components. An excellent example of this pressure versus depth difference is related by J. Piccard in *Seven Miles Down*. **TRIESTE's** depth at the bottom of the Challenger Deep was measured at 37,800 feet on a pressure/depth gage calibrated in fresh water; subsequent corrections for specific volume, gravity, compressibility and temperature reduced this to 35,800 feet. An inaccuracy of 2,000 feet in depth was, from a safety standpoint, no real concern because **TRIESTE's** pressure hull had a safety factor of 2 which would take it to a computed collapse depth of 72,000 feet.

The greatest area for concern is evidenced by the scientist or engineer who wants the

depth of his *in situ* observations with the utmost accuracy. To obtain more accurate pressure/depth measurements vibrating wire transducers and quartz capacitance pressure transducers have been constructed in oceanographic instruments and provide greater accuracy than the instruments described heretofore.

In June 1967 the Marine Technology Society sponsored the symposium "Precise Determination of Pressure/Depth in the Oceans." Selected papers presented at this symposium are contained in reference (9), which describe the limitations, construction and testing of specific pressure/depth sensors.

Seemingly incidental but quite important to a variety of missions, is the method or device used to present and/or record vehicle depth during a dive. On many missions the only importance attached to depth is that of safety and in this case the operator need know nothing beyond what the depth is at any given time. However, in surveying, environmental studies and cable inspections depth is a critical parameter and is the basis to which all observations are related. In such cases a record of depth versus time is invaluable in reconstruction of the dive and relating observations to their proper depth category. One can always record the time and depth with each observation, but in the small confines of submersibles this is not always convenient and many times the observer may simply forget to do so. Strip chart recorders of the Rustrak variety are available which are small and trace an imprint on a paper scroll; these require electric power to operate. *BEN FRANKLIN* used a Swiss-built ink recorder which traced on a depth/time calibrated paper strip and was powered by a wind-up-motor, 8-day clock (Haenni S.A. Model 89RE, Jegenstorf). The recorder was invaluable in post-dive reconstruction relating events to time and depth.

**Sonic Devices** —Depth measurements from submersibles using sonic devices are approached in the same manner as a surface ship measures bottom depth, but instead of measuring the round trip time interval of an acoustic impulse from surface to bottom, it measures the round trip time interval from vehicle to surface. A number of submers-

ibles, thus, have upward-looking sonar transducers for this purpose. The accuracy of such measurements can be better than many of the pressure sensors, but this accuracy depends upon the accuracy with which the time between the outgoing and returning impulses is measured, and the accuracy with which sound velocity in the overhead water column is known. The time measurement accuracy is the instrument error and in contemporary echo sounders is considered negligible. The sound velocity error, however, can be considerable and is the controlling factor in accuracy. An indication of the errors brought about by seawater sound velocity variation can be seen from Figure 10.12 (constructed by Mr. J. Berger, U.S. Naval Oceanographic Office), which shows the corrections versus depth which are required for a standard sound velocity of 1,500 m/sec (4,920 ft/sec) off the west coast of Greenland and off Gibraltar.

In most instances the sonic devices are used during ascent for safety purposes to monitor closure rate with the surface rather than depth. The reason is quite simple:



Fig. 10.12 Depth corrections for echo sounder (1,500 meter/sec).

Power, not only for the recorder or monitor, but for the transducer as well. Additionally, sonic devices are more complex than pressure sensors, heavier and larger. Figure 10.13 shows examples of both pressure gage and sonic depth recording devices on sub-

mersibles and also includes other indicators found in current submersibles.

**Altitude** —By altitude is meant distance-off-the-bottom, and this information is used during descent so that the operator can reduce his speed to a safe level upon approaching



Fig 10.13 Various indicators and equipments aboard STAR III. (Gen. Dyn. Corp.)

the bottom. Information regarding altitude is also required when a mission calls for flying or hovering while maintaining constant distance from the bottom. The device used is invariably a downward-looking echo sounder similar in operation, display and constraints to that described for the depth indicating echo sounder. Indeed, *DS-4000* uses the same transducer for looking up or down by hydraulically turning it in the desired direction.

For precision control, however, the sonic devices' inaccuracies may be unacceptable, and when the submersible's transducer is too close to the bottom the return signal can be masked by the outgoing signal such that no altitude values are obtained. In a few cases where level flight, regardless of distance-to-bottom, was desired a device called a differential pressure gage was employed. Bass and Rosencrantz (10) described such a system

they used to fly on a horizontal plane or isobaric (equal pressure) surface to conduct photographic missions with *ASHERAH*. A diagram of *ASHERAH*'s so-called isobaric altimeter system is presented in Figure 10.14. The system provides data under the assumption that at 100 feet or more depth (for sea state 2) pressure fluctuation, due to waves, is attenuated such that a horizontal plane parallel to mean sea level is defined by an isobaric surface. When the bypass valve is open, seawater enters the system, rises in the pressure accumulator, and compresses the entrapped air such that the pressure is equal to the ambient sea pressure. The differential pressure gage reads zero because the pressure is the same on both sides. When the submersible reaches a desired flying height, the bypass valve is shut. The pressure accumulator now provides a constant pressure reference for the desired flying

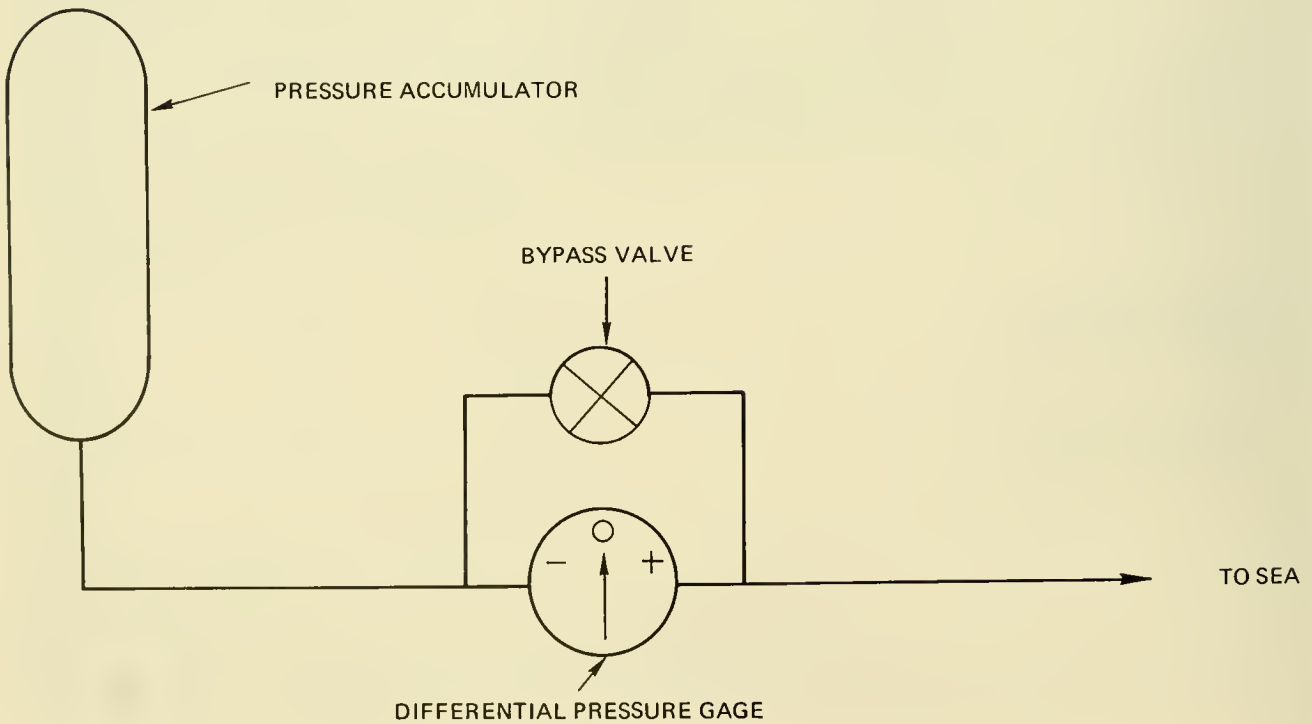

Fig. 10.14 The isobaric altimeter system. [From Ref. (10)]

plane, and the differential gage reads the deviations of the submersible from that plane. The pressure accumulator was a small high-pressure air bottle. The differential pressure gage was manufactured by Whitaker Corporation's Pace Wianco Division, as was the pressure transducer (model P7) which operates on a variable reluctance principle. A demodulator carrier provided the proper input and output voltage conditioning. The gage system has the following characteristics:

- Input voltage = 22 to 32 VDC
- Range = 5 feet (= 2.5 psi)
- Output voltage gradient = 1 volt/foot
- Linearity = 0.5% best straight line
- Output impedance = 2 kilohms
- Resolution. Infinite
- Volumetric displacement = 3 (10<sup>-4</sup>) cubic inch.

A meter readout for this gage was mounted on the pilot's control panel to serve as a navigation aid and to indicate *ASHERAH*'s position relative to the horizontal reference plane.

#### Speed Indicators:

Because a submersible travels in three dimensions, both lateral and vertical speeds are sometimes measured.

**Vertical Speed** —Rate of descent is an important parameter for deep-diving submersibles, mainly because of the danger of hitting the bottom too hard. A knowledge of descent rate allows the operator to adjust ballast or buoyancy to slow down (or speed up). Desire for knowledge of the vehicle's ascent rate appears (from conversations with operators) to be essentially for academic reasons.

The most basic vertical speed indicator was described by A. Piccard (*In Balloon and Bathyscaphe*) for the bathyscaph *FNRS-2*. Taking a vane anemometer (identical to that used by balloonists), Piccard mounted it on the top and out to the side of the vehicle's float. The anemometer is a four-bladed fan that rotates in proportion to wind (or water) speed, or the vertical speed of the balloon and in this case was rotated by the vertical motion of the bathyscaph. Because it could not be visually observed, each rotation was electrically signaled through the hull on a different code for ascent and descent. Each

complete revolution corresponded to a predetermined distance, and the frequency of the revolutions was observed in the hull as a luminous sparking.

A second method is used by *SEA CLIFF* and *TURTLE* where sequential values from the pressure transducer are differentiated and displayed as a rate of change function.

A third and most widely used method simply times the rate of descent or ascent through selected depth intervals from the up/down echo sounder trace. The few vehicles that have a Doppler Sonar, described later in this section, can also derive rate of ascent/descent from this device.

By and large, few submersibles measure vertical velocity and, when they do, descent rate is the most important parameter.

**Lateral Speed** —Similarly, knowing one's speed across the bottom is of little value to the operator. To the scientist, however, it is a useful factor in reconstructing area observed per unit of time. For example, in biological studies where the number of visible bottom dwelling (benthic) organisms per area traversed is desired, speed is critical in determining the distance covered in the absence of other navigation or locating systems.

There is a wide variety of methods for measuring a vehicle's speed, but the two most generally used are the Savonius Rotor and the Rodometer.

A Savonius Rotor current meter is shown in Figure 11.4 (Chap. 11). *DS-4000* used a similar rotor for speed measurements. As the rotor is turned by water movement, a reed switch is activated to send electric pulses through *DS-4000*'s hull and to produce a signal on a readout. Each full rotation correlates to a given distance through the water which is displayed, generally, in knots. Concurrently, each rotation can be summed to provide distance traveled; in this fashion the rotor acts as an odometer. The obvious problem is: How does one account for speed added or subtracted by water currents? On surface ships the same problem is encountered when measuring wind speed underway, but surface ships generally know with fairly good accuracy their speed through the water at various shaft rpm's. Knowing this, calculations for apparent wind speed can be made which ultimately provide true wind speed

and direction. Few submersibles have run speed trials over measured distances. As a result, the rotor's effectiveness as both a speedometer and odometer is suspect.

*SEA CLIFF* and *TURTLE* employ a different method to measure speed and distance, a rodmeter. The rodmeter is the speed sensing element of the EM (electromagnetic) log. It is about 12 inches high and 6 inches long, with an airfoil cross section. The active part of the rodmeter is an encapsulated coil which is excited by an indicator transmitter and sets up a magnetic field in the surrounding water. Two insulated pickup buttons, one on either side of the rodmeter, sense the voltage induced in the water (seawater is an electrolyte) moving past the rodmeter and cutting the magnetic flux set up by the coil. The voltage sensed by the pickup buttons is proportional to the speed at which the water moves past the rodmeter and, after processing by the indicator transmitter circuitry, it drives the speed and distance indicators. Accuracy constraints similar to the rotor attend this method. The Doppler sonar, described later in this chapter, is a far more accurate speed measuring system and is finding increased application.

### **Pitch/Roll Indicators:**

For a variety of reasons, including both safety and operational considerations, it is desirable to know and not exceed certain pitch or roll (trim) angles in a submersible. Of all instruments in a submersible, these indicators are the simplest, most reliable and consist merely of a bubble in a liquid confined in a curved, degree-marked glass tube. One such device or inclinometer is shown at the top of Figure 10.15 (item 43). Generally, one inclinometer is mounted on the vertical centerline athwartships plane to provide roll angle and one exactly amidships in the vehicle's vertical fore and aft plane to provide pitch. In the more sophisticated vehicles, rate of pitch, as well as angle, is measured and displayed as shown in Figure 10.15.

At this point the detectors, monitors and recorders found on submersibles become unique to each vehicle and a matter of personal philosophy. A similar range of variations is found in the means used to monitor

and detect the status of various vehicle components. Table 10.1 lists the most common status indicators. The reasons for wanting to know how much compressed air or battery power is left or if there is a leak in some critical compartment are obvious and need no explanation. Other indicators and measurers, as mentioned, either reflect the builder's philosophy concerning what's important to measure on his vehicle or are added to increase its capabilities. Hence, rather than list such personal choices, the reader is referred to Figure 10.15 which depicts what *DEEP QUEST*'s designers consider to be necessary indicators, detectors and controls. Except for the *DSRV*'s, it is unlikely that any other vehicle exceeds this in scope. It should be noted that this (Fig. 10.15) is only one segment of *DEEP QUEST*'s control station and it has been modified since this photograph was taken.

### **Communications**

Communication systems in manned submersibles are used for the following purposes: Sub-to-ship (surface); sub-to-ship (sub-surface-to-surface); sub-to-diver (subsurface); atmospheric chamber-to-lock-out chamber (intra-vehicle). Systems which perform these functions are radio transceivers (AM and FM), underwater acoustic telephones and hardwire (sound powered) telephones. The following discussion is concerned only with routine operational communication requirements and systems; the role of communications to avoid and assist in emergencies is discussed in Chapter 14.

#### **Surface Communications: (Radio)**

From a routine operational point of view, communications on the surface provide for pre-dive vehicle checkout and status reporting to the surface ship. Post-dive functions are primarily concerned with rendezvousing with the support ship for subsequent retrieval.

During both the pre- and post-dive periods the range between support ship and submersible is maintained at less than 1 mile; hence, short-range surface communication systems serve adequately. Most vehicles rely on line-of-sight, portable radio transceivers in the ultra-high-frequency or citizen's band



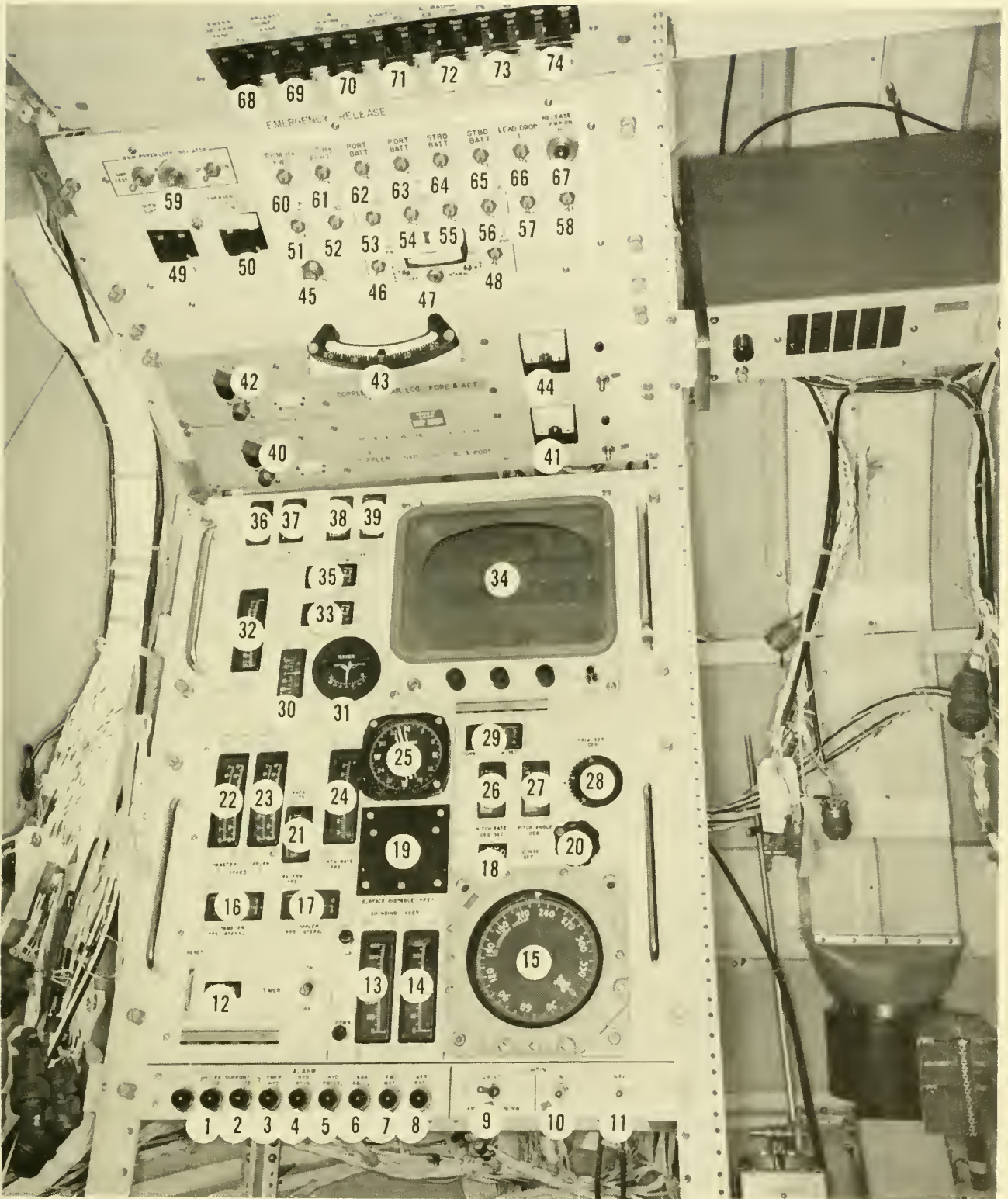

Fig. 10.15 Vehicle status control and indicators on *DEEP QUEST*. (LMSC)

1. OXYGEN
2. EMERGENCY HYDRAULICS
3. HYDRAULIC RESERVOIR
5. HYDRAULIC PRESSURE
6. VARIABLE BALLAST
7. FORWARD BATTERY
8. AFT BATTERY
9. 28 VDC EMERGENCY AND NORMAL LIGHTING
10. INTERNAL LIGHTING
11. NAVIGATION (OUTSIDE) LIGHTS
12. DEPTH (VEHICLE) IN FEET
13. DEPTH UP/DOWN 0-600-FT.
14. DEPTH UP/DOWN 0-60-FT.
15. GYRO COMPASS REPEATER
16. LATERAL SPEED COMPONENT (THRU WATER)
17. DOPPLER SPEED (OVER GROUND)
18. COURSE SET READOUT (DEGREES)
19. DISTANCE TO SURFACE (FT.)
20. COURSE SETTER
21. SPEED BASED ON PROPELLER RPM.
22. LATERAL SPEED COMPONENT (THRU-WATER) -  
SPEED BASED ON PROPELLER RPM.
23. DOPPLER SPEED (OVERGROUND)
24. ASCENT/DESENT RATE INDICATOR (FPS)
25. MAGNETIC COMPASS REPEATER
26. PITCH RATE (DEG/SEC)
27. PITCH ANGLE (DEG)
28. TRIM SET (DEG)
29. TURN RATE (DEG/SEC)
30. STERN PLANE ANGLE
31. RUDDER ANGLE
32. DEPTH
33. AFT LATERAL THRUST (LBS)
34. TV MONITOR
35. FORWARD LATERAL THRUST (LBS)
36. VERTICAL THRUST AFT (RPM)
37. VERTICAL THRUST FORWARD (RPM)
38. PORT PROPELLER (RPM)
39. STARBOARD PROPELLER (RPM)
40. DOPPLER FREQUENCY RANGE SELECTOR
41. VOLTAGE INDICATOR (OUTPUT) DOPPLER
42. DOPPLER FREQUENCY RANGE SELECTORS
43. ROLL INCLINOMETER
44. VOLTAGE INDICATOR (OUTPUT) DOPPLER
45. EMERGENCY RELEASE CIRCUIT TEST LIGHT
46. EMERGENCY POWER FOR EMERGENCY HYDRAULIC SYSTEM READOUT
47. EMERGENCY HYDRAULIC PRESS READOUT AND POWER SOURCES SELECTION
48. NORMAL POWER FOR EMERGENCY HYDRAULIC SYSTEM READOUT
49. NORMAL POWER SUPPLY CIRCUIT BREAKER
50. EMERGENCY POWER SUPPLY CIRCUIT BREAKER
51. TRIM MERCURY AFT (DROP SWITCH)
52. LIST MERCURY STARBOARD (DROP SWITCH)
53. PORT PAN/TILT MECHANISM (DROP SWITCH)
54. STARBOARD PAN/TILT JETTISON SWITCH
55. RAMP JETTISON SWITCH
56. ANCHOR JETTISON SWITCH
57. EMERGENCY WEIGHT DROP JETTISON SWITCH

58. SIGNAL BUOY RELEASE JETTISON SWITCH
59. MAIN POWER LOSS INDICATOR
60. TRIM MERCURY FORWARD
61. TRIM MERCURY AFT
62. JETTISON SWITCH PORT BATTERY
63. JETTISON SWITCH PORT BATTERY
64. JETTISON SWITCH STARBOARD BATTERY
65. JETTISON SWITCH STARBOARD BATTERY
66. EMERGENCY WEIGHT DROP
67. POWER TO EMERGENCY SWITCHES

#### CIRCUIT BREAKERS

68. EMERGENCY RELEASE PANEL
69. BALLAST CONTROL PANEL
70. UNDERWATER TELEPHONE
71. LIGHTS (INTERNAL)
72. COMMUNICATIONS PANEL AND RADIO
73. EXTERNAL POWER CONTROL PANEL
74. LIFE SUPPORT

category (Table 10.5), which provide communications up to 50 miles although not more than 10 or 15 miles are obtained. The extensive use of these frequencies, both at sea and ashore, has led to a wide variety and quality of available equipments.

Some of the larger vehicles use much longer-range surface communications systems. *ALUMINAUT*, for example, carried a 75-watt radio transceiver with six channels and broadcast on 2 to 6.5 MHz. This system

included the Coast Guard emergency frequency of 2182 kHz and frequencies compatible with the nearest commercial marine operator.

Support ship radio requirements in addition to those connected with submersible communications can be extensive. In most open-sea operations (military or civilian) someone, somewhere must be kept abreast of the mission's progress. Additionally, breakdowns, delays and the need for spare parts or

TABLE 10.5 STANDARD RADIO BAND TERMINOLOGY

Frequency Range		Band Name	Abbreviation
From	To		
...	below 30 kHz	Very-low-frequency	VLF
30 kHz	300 kHz	Low-frequency	LF
300 kHz	3 MHz	Medium frequency	MF
3 MHz	30 MHz	High-frequency	HF
30 MHz	300 MHz	Very-high-frequency	VHF
300 MHz	3 GHz	Ultra-high-frequency	UHF

additional personnel will inevitably occur. Since such needs are met from shore-based activities, the support ship must be capable of communicating at least to the source of such support. Quite frequently, it is possible to operate using only the nearest marine operator for such shore communications. The primary difficulty with this arrangement is that one must frequently wait for a period of time to make the call. This makes for difficult schedule keeping if a predesignated time is set for situation reports. On the other hand, as long as this inconvenience is appreciated beforehand, the commercial operator serves adequately.

During a number of open-sea operations with U.S. Naval agencies, a Single Side Band (SSB) radio was installed on the support ship for direct communications with the agency involved. Using this system is more convenient than going through a commercial operator, but the cost can be quite severe, because both the shore and sea components must be furnished and installed.

The allocation of radio frequencies for use at sea is governed by the Federal Communications Commission for non-government users and the Interdepartment Radio Advisory Committee for government users. It is beyond the scope of this discussion to relate the details of obtaining frequencies and the attendant legal considerations, but reference (11) presents a succinct treatise highlighting the pertinent rules and regulations for U.S. users.

### Sub-Surface Communications:

Communications between the submerged vehicle and its support ship serve a variety of purposes. For the most part, however, the dialogue is concerned with status reports—more simply, to enable the support ship to keep abreast of what's going on in the submersible. In an emergency the purposes and needs are quite different, and the considerations involved in selecting a carrier frequency and the nature of the device are discussed in Chapter 14.

Once the vehicle is submerged the frequency of conversations with the surface is minimal; purposefully so, because the pilot and observer(s) have enough work to do without distractions from above. For this reason several operators have designed a code whereby all routine (and emergency) traffic is transmitted with minimal dialogue. One such code is presented in Table 10.6 and was used between *DS-4000* and its support ship. Such codes also conserve power and, in the event that reception is weak or garbled, can be more easily understood and interpreted.

Probably the simplest code used to ask if things are going routinely is to click the transmit button two or three times. Such clicks are quite distinguishable in the vehicle, and the operator need merely click back a return OK.

When a submersible has no independent means of navigation and is required to follow a certain path, frequently it is tracked from

TABLE 10.6 DS-4000 RADIO/TELEPHONE CODE LIST

Prefix	Suffix	Emergency Signals
DELTA — Dive	1—Ready; Standby	XRAY 31—FIRE
ALPHA — Ascent	2—Commenced; Start	XRAY 32—UNCONTROLLED ASCENT
X-RAY — Emergency	3—Trouble; Rescue Me	XRAY 33—UNCONTROLLED DESCENT
PAPA — Minor Problem	4—Caution; Stand Clear	XRAY 34—HUNG ON OBJECT ON BOTTOM
NOVEMBER — Navigation	5—Normal, OK	XRAY 35—MUST EXIT VEHICLE
MIKE — Motor	6—Arrived at	XRAY 36—CRANE IS INOPERATIVE
LIMA — Information	7—STOP, Stopped, Completed	XRAY 37—NECESSARY TO DROP FORWARD BATTERY
CHARLIE — CO <sub>2</sub> % is	8—Need Assistance — Send Divers	XRAY 38—COLLISION (on surface)
FISH — Depth Reading	9—Conditions Poor, Abnormal	XRAY 39—REQUEST IMMEDIATE PICK-UP
TANGO — Tracking	10-5—I Understand, I Will Obey	GENERAL CALL — MAY OAY
WHISKEY — Weather		

the surface and its course directed on the underwater telephone.

By and large, most submersibles employ sonic (wireless) communications systems relying on the water column, instead of a wire, to carry the conversation. The carrier frequencies employed in commercially available devices commonly are 8, 28 or 42 kHz. Several factors weigh heavily on the choice of frequencies: range, ambient noise and compatibility with other communication systems.

Range of an underwater telephone is then a problem of signal strength versus refraction, reverberation, scattering and the ambient noise at the receiver. Ambient sea noise has a large low frequency content; hence, a low frequency communications system must compete with this, but, on the other hand, low frequency sound is less absorbed on its way to the receiver. The selection of the carrier frequency or communications system is a compromise of all the above factors. Table 14.7 (Chap. 14) presents ranges of various communicating systems; these are advertised ranges, and, as the manufacturers agree, they are not always attainable.

The majority of submersibles use a system operating at 8.0875 kHz for sub-to-surface communications. This frequency is good for range in areas of little ambient noise. The higher frequencies (28, 42 kHz) provide good short- to medium-range communications and are usually used in sub-to-diver and diver-to-diver systems. Because the submersible itself is a noise generator, one must consider it as a negative factor in the selection of a diver-to-sub wireless communication system.

Chapter 2 briefly discusses sound propagation in the sea. A wide-ranging and comprehensive treatment of underwater acoustics can be found in reference (12). For purposes of this discussion, it is sufficient to note that the velocity of sound in a liquid varies with temperature, salinity and density. Previously, it was explained that sound waves may be bent (refracted) and do not always follow a straight path. To further complicate its transmission, a sound can be scattered by objects in the water and large objects (including the bottom and the surface) can produce echoes (reverberation). The result is to distort the signal such that intelligible com-

munications are difficult. Added to this is noise produced by animals, the sea surface or ship traffic which may act to mask or drown out the communications. Finally, the signal itself spreads as it travels to a receiver and this spreading loss also results in signal degradation (with strength dropping as the cube of the distance). Since all of these factors vary constantly, communications can be excellent one day and, for all practical purposes, non-existent the next. In some instances communications can vary within the tenure of a 5- or 6-hour dive depending upon the terrain or environment over, within or under which a vehicle may operate.

The ambient diver confronts all of the problems found in submersible communications and quite a few in addition: The diver must have full freedom of mouth and lip movements to enunciate words, the face mask cavity into which he speaks often enhances lower frequencies and attenuates higher frequencies, exhalation of bubbles interferes with communications, and his hearing sensitivity is less in water than in air. If the diver is wearing a helmet the problems also involve ambient noise caused by air injected into the helmet and expired air escaping through the exhaust valve. When helium (instead of nitrogen) is used with oxygen a further complication arises in that this lighter gas medium causes a shift in the speech frequency and a resultant "Donald Duck" effect, but converters are available that can reconstruct the diver's voice so that it is intelligible (13).

A number of commercial diver communication systems is available, and tests have shown their performance as adequate (14). Where one offers good intelligibility it may fail in reliability or vice versa. The improvements in this area within the sixties have been quite remarkable, and it is likely that the increasing use of divers and lock-out submersibles in the offshore oil industry will focus more attention with subsequent solution of those problems that remain.

Hardwire telephones to the surface have been used since the advent of the hard-hat diver, and the number of systems available is large. All the tethered submersibles use a hardwire telephone system, and in a few of the very shallow submersibles (*e.g.*, the *NAU-*

*TILETTE* series) a hardwire telephone line is held at the surface by a buoy, while a small boat accompanies it and communicates with the occupants below. The disadvantages of this method are obvious, including: Reduced maneuverability, the problems of "buoy keeping" in strong surface currents or winds and the potential for entanglement. The proponents point out, however, that the buoy-hardwire arrangement is inexpensive and also serves as a way to track the submersible.

Sound-powered telephones find application in lock-out submersibles for communications between the diver's and operator's compartments. On the *JOHNSON SEA LINK* a sound-powered phone provides communication between the acrylic operator/observer's sphere and the aluminum diver lockout cylinder. Basically, the sound-powered telephone may rely on one device to both transmit and receive. Sound waves striking a diaphragm cause it to vibrate. The motion of the diaphragm changes the magnetic field of a permanent bar magnet adjacent to the diaphragm, which induces electric current of varying voltage and amperage in a winding connected to an identical device at the other end. These changes travel to the opposite end where identical changes occur in its magnet and cause the diaphragm to reproduce the original sound. Because the power input is small, so is the range of transmission, but it is quite adequate for the application and requires no external source of power other than one's voice.

The most fundamental communications system is frequently used during the pre-dive surface checkout. This consists of prearranged arm and hand signals on the part of the diver and submersible operator. There are standard diver hand signals which the Navy Diving Manual illustrates, and these are frequently followed. A few vehicles install a sound-powered telephone in the free-flooding sail which the diver uses to accomplish the same purpose when on the surface.

## NAVIGATION

The term navigation, as used herein, refers to the submersible system's ability to answer: Where do we go, where are we and

where have we been? It is important to note that the whole *system* is involved in supplying such answers, because few, if any, vehicles have the ability to navigate independently of surface support. The reason is quite simple: Contemporary submersibles are not large enough to carry both surface and sub-surface navigating equipment. The ship-board navigator might rightfully question the inordinate volume requirements of a sextant, but, to be quite pragmatic, a sextant or other visual locating devices simply does not provide the accuracy or repeatability required by submersibles in the open sea. To find and reacquire a cable, pipeline or other hardware, for example, the submersible's position at launch must be known to the best accuracy possible so that electrical power will not be consumed merely trying to find the object of interest. To perform this task, electronic aids to navigation have taken precedence over the sextant.

The means of establishing the surface support platform's geographic location (for subsequent extrapolation to the submersible's undersea position) are many and varied. The subject has been treated extensively since man first set out to sea. Hence, surface positioning *per se* will not be discussed. For what is probably the most comprehensive treatment in existence on the methods and means of surface positioning, reference (15), the *American Practical Navigator* or, more commonly, Bowditch is recommended. More recent developments, applications and problem areas in this subject are presented in references (16) and (17), the first and second symposiums on Marine Geodesy, respectively. Before leaving this subject, it must be realized that all present underwater positioning systems are ultimately referred to the surface position. Thus, any errors introduced on the surface are carried directly to the sub-surface. Table 10.7 lists selected contemporary electronic surface positioning systems and provides an appreciation of the magnitude of error encountered with each system.

Determining a submersible's undersea location relative to the surface fix is approached in two ways: The first involves tracking of the vehicle by the surface ship and requires no related action on the part of the submersible operator; the second ap-

TABLE 10.7 SELECTED SURFACE POSITIONING SYSTEMS [FROM REF. (18)]

System Type and Name	Manufacturer	Range	Accuracy (rms positions)	Users	Frequency	Signal/Processing Type*
<b>CONVENTIONAL RADIO NAVIGATION</b>						
Short Range Cubic Autotape DM-40	Cubic Corp.	50 km	2-10 m	1	3,000 MHz	P-Ph
Hydrodist MR8-2	Tellurometer	50 km	3-30 m	1	3,000 MHz	P-Ph
Medium Range Decca Hi-Fix (medium power)	Decca Systems	300 km	5-50 m	Multi	2 MHz	CW-Ph
Lorac B	Seiscor	500 km	5-100 m	Multi	2 MHz	CW-Ph
Long Range Loran A	Sperry Rand, ITT, others	1,200 km	1.5-8 km	Multi	2 MHz	P-ph
Loran C		1,800 km	15-400 m	Multi	100 kHz	P-Ph
Global Omega	ITT, Tracor, Nortronics	800 km	800-3000 m	Multi	10 kHz	P-Ph
<b>POSITION FIXING BY SATELLITE</b>						
AN/SRN-9 receiver + choice of computer	ITT		Single-fix 60-120 m (average fix interval 90 minutes)			
702 receiver + choice of computer	Magnavox	Global		Multi	150 and 400 MHz	Doppler
Update Geo Navigator	Honeywell					

\*P: Pulse  
 Ph: Phase Comparison  
 CW: Continuous Wave

proach is all on the part of the submersible operator and, once underwater, is independent of the surface ship. Between both of these extremes (surface-dependent versus independent positioning) are a number of variations. For convenience, the surface-dependent methods are categorized as Surface Tracking and the independent methods as Submerged Navigation. A third aspect of navigation, intermediate between where do we go and where have we been, concerns locating a target and going to it; this function is termed "Homing," and is also discussed.

It is very difficult to speak of navigation

without discussing accuracy and within the confines of this section it is impossible to discuss adequately the many factors involved in navigational accuracy. Accuracy is defined as the degree of conformance with a correct value. But, in regards to an object's location on the planet Earth, even the "correct value," in terms of its latitude and longitude, is accompanied with inaccuracies under the most exacting measurements. Navigation, according to Bowditch, is not an exact science and a number of the approximations used by the conventional navigator would be unacceptable in careful scientific work. The navigator, however, is a pragma-

tist, and greater accuracy may not be consistent with the requirements or time available, or, most importantly, there may be no alternative. For the submersible operator, accuracy becomes an overriding consideration when he asks: Where are we, or where is it? because the answer must always be qualified as: We're right here, plus or minus several hundred yards, feet or several miles. The inaccuracy in a position may have extreme consequences underwater, because, for example, precious battery power must be spent maneuvering to find a particular site or object. Searching for and acquiring an object in the deep ocean is an extremely frustrating experience. In the first place, one only has the area of the vehicle's lights in which to look. Secondly, once the object is found the vehicle must stop, but stopping takes some distance and the submersible usually passes over or by the object. It then must turn around and relocate it. This may sound simple, but it isn't. For example, in 1970 under a contract with the Naval Oceanographic Office off San Clemente Island, *DEEP QUEST* passed over an unusual rock pedestal at 2,820 feet deep. The operator immediately bottomed the vehicle and turned 180 degrees to return to the rock. Some 2 hours later the search for the pedestal was unsuccessful and terminated due to the press of time. Numerous examples similar to this can be found in reports from other vehicles.

Let us hypothesize that the rock mentioned above had been located, and it became necessary to surface and return to the rock again. Generally, the procedure would be to maneuver as close to the rock as possible and, using whatever means available, obtain one or more fixes (positions) on the rock's location. Returning to the rock now introduces another term describing a navigation system's capabilities, "repeatability." Quite simply, repeatability is a measure of how closely the system can bring the vehicle back to the rock, and in certain types of underwater work it can be as important as accuracy. The geologist, for example, may be quite content to know that the rock we mentioned is approximately 5 to 6 miles south of San Clemente; the exact geographic location (accuracy) may be unimportant. What is impor-

tant is that he can return to look at or sample this rock without undertaking a major search expedition. Likewise, the surveyor who has found and mapped a suitable cable route can accept the fact that the centerline of the route is plus or minus a half mile from some point on the earth's surface; his main concern is that the centerline of this route can be reacquired and the cable laid thereon.

Accuracy, therefore, is a measure of how closely a navigation system can locate the submersible on the earth's surface; repeatability is a measure of how closely the system can get it back to that spot.

### Surface Tracking

In a few instances—especially in the early years—the requirements for a geographic positioning system were rudimentary at best. *FNRS-2* and *3*, *TRIESTE I*, *SP-350* and *ALVIN* among others, asked nothing else of the surface ship but to stand clear when they surfaced. This was accomplished via the underwater telephone, whereby the surface ship, knowing that the vehicle was returning, kept well clear. As a result, both were quite far from each other and in 1965 *ALVIN* required assistance from a Coast Guard aircraft to reunite with its support craft (19). But, as soon as technology made it possible, this casual approach was replaced. What follows is not an orderly chronological development of submersible tracking systems because, quite simply, there was and is no orderly development. Some still use devices which were used in early fifties, while others use systems of the seventies. The discussion, therefore, shall begin with the most basic and proceed to the more sophisticated tracking systems.

### Marker Buoys:

Simple in concept but quite difficult in practice, one of the first attempts to ascertain the whereabouts of the submerged vehicle was the marker buoy. In this approach a suitable length of line was attached to the vehicle with a surface buoy on the other end. The surface craft merely kept track of the buoy and took compass bearings on it relative to itself. By keeping a continuous plot of its own position, the surface ship needed merely to draw a post-dive plot of its track and that of the buoy to reconstruct the vehi-



cle's underwater course. Mr. John Barringer quite succinctly outlined a few of the problems with this approach that *PC-3B (CUBMARINE)* encountered off Spain in the 1966 H-bomb search (20).

*"An inflatable buoy about three feet in diameter was attached to the submarine by a length of polypropylene line. As the sub pulled this buoy around, range and bearing from the ship to the buoy could be determined, and a rough estimate of CUBMARINE's location made. Various factors contributed to the inaccuracy of this system. The length of line from the submarine to the buoy was roughly twice the depth of the sub. (Should the line foul on some underwater projection, enough line was desired to allow CUBMARINE to surface without having to pull the buoy under. The sub's power is not sufficient to pull the buoy under and hold it there. Also, surface action of the sea naturally moves the buoy up and down, and if the line were taut, CUBMARINE would be moved up and down with it.) Action of the wind, sea, and current greatly affected the position of the buoy. It was sometimes a very unreliable indicator of the submarine's course. For example, when CUBMARINE executed a 180 degree turn, the buoy would travel for a time in the opposite direction the submarine was going, a potentially hazardous situation. Once when working with the MSO (minesweeper), sonar contact with the submarine had been lost just about the time she had made a turn. The MSO continued to steer a course which would normally have been a safe following one. At this crucial time communication with CUBMARINE was also temporarily disrupted. Suddenly, the buoy stopped its forward progress, turned, and headed directly for the ship. The ship veered sharply, but not in time. The buoy line fouled in her screw, and CUBMARINE was unceremoniously yanked from the bottom. Fortunately, the line parted long before she could be reeled up into the screw."*

While the marker buoy may seem to possess a capricious will of its own, it is used nonetheless on quite a few vehicles in shallow water operations.

#### **Active Sonar Ranging:**

Essentially a steel bubble, the submersible is an excellent reflector of sound. One approach, therefore, that would seem an excellent candidate tracking system is that of pinging\* off the submersible's hull from the surface and calculating a range and bearing to the submersible. But several factors inhibit application of this system. First, when the submersible operates on or close to the bottom, the echo from the bottom is as strong as that from the vehicle itself, and the return ping from the vehicle usually is indistinguishable from the bottom. Secondly, if a ridge or other large object comes between the surface ship and the submersible, contact is lost. These two considerations and the fact that the best of these systems resides in the domain of the military have resulted in very little use of active sonar ranging.

The only reported application of this system is, again, by Barringer (20) with *CUBMARINE* in the Spanish bomb hunt.

*"The method employed to track CUBMARINE when she was submerged was one fabricated of necessity and was far from adequate for the task. It was relatively successful for vectoring CUBMARINE into the area of a positive sonar contact, but was of little value in making a geographical plot of her progress. An MSO, with its UQS-1 sonar, acted as control ship for each of CUBMARINE's dives. The ship would search the bottom with her sonar, and when a target was located CUBMARINE would dive. The sonar operator would acquire the submarine as she dived, and would give the pilot courses to steer until the target "blip" and CUBMARINE's "blip" merged on the sonar screen.*

*Sometimes this procedure would put CUBMARINE within a few feet of the target. More often, however, the target was not within her range of visibility (usually 15-20 feet). Then she would search in an outwardly spiraling pat-*

tern. Success with this procedure was often thwarted by the current. As *CUBMARINE* increased the diameter of her circling pattern, she was pushed continually down current, so that the ground track of the spiral search pattern became corkscrew shaped. The pilot was unable to correct for this, as he had no navigation system, and visibility was too poor to allow him to visually fix a spot on which to circle. If the spiral search failed to locate the target, another sonar vectoring attempt was made.

Plotting the track of *CUBMARINE*'s progress was an especially frustrating problem. A continuous plot of the MSO's track was maintained using Decca Hi-Fix and/or range and bearing fixes from landmarks on shore. *CUBMARINE*'s position was then plotted relative to the known position of the MSO. Two procedures were employed simultaneously in the plotting of *CUBMARINE*'s position. The primary system was for sonar to determine the relative range and bearing of the submarine from the MSO. This method was subject to the inherent inaccuracies of the sonar, and was also largely dependent on the proficiency of the sonar operator. Keeping sonar contact with both the target and the submarine was often a difficult task for the sonar man. As he adjusted the focus of one he could easily lose contact with the other."

In the same report Barringer notes that this system was replaced by the marker buoy, the adequacy of which has been described.

#### **Pinger (Sub)-Hydrophone (Surf):**

One of the earlier approaches to tracking was by the attachment of a pinger to the submersible and a baffled hydrophone to the surface ship. As the submersible's ping was received by the support ship it would orient the hydrophone until the loudest ping was obtained, and from the direction in which the receiving element was pointing, the relative bearing of the submersible was obtained. Slant range, on the other hand, was ob-

tained from the submersible's UQC. In some instances the hydrophone was lowered directly from the support ship; in others, it was lowered from a small boat. The latter approach introduces a new set of errors, because now the range and bearing from support ship to small boat must be obtained before the relative slant range and bearing to the submersible can be calculated. Figure 10.16 diagrams the tracking procedures for *STAR III* and *DS-4000*; the origin of the ship-to-small-boat error is apparent.

Pollio (21) describes this tracking system as follows: A 20-kHz pinger on the submersible was tracked from the small boat by a baffled hydrophone oriented to obtain the loudest ping. The hydrophone angle to the submersible was estimated, and the heading of the small boat was obtained from an "automobile-type" compass. Slant range from small boat to submersible was found through the underwater telephone and a stopwatch with a verbal "Stand-by-Mark" command from the surface. Range and bearing to the small boat from the support ship was estimated. Pollio estimates at least a 400-yard horizontal position error for the submersible relative to the support ship.

A variety of pinger frequencies can be and has been used (e.g., 20, 27, 37 kHz), and in the early dives of *ALVIN* (and others as well) the 8-kHz underwater telephone was set on CW transmission. This continuous wave signal was received by a trainable line-hydrophone for bearing. A further modification to *ALVIN*'s telephone provided transponder range on the surface ship's telephone. According to Rainnie (19) this system gave an estimated position accuracy of the submersible relative to the support craft of  $\pm 380$  yards (1,140 ft) at 6,000 feet in depth.

The shallower such systems are used, the better the accuracy, but for precise surveying they are of little value. Repeatability is another area that suffers, and the following account of a current meter array recovery by *ALUMINAUT* provides an excellent, if not classic, example of the inadequacies, frustrations and ingenuity of early tracking systems, submersibles and crew, respectively. (Chapter 11 describes the salvage equipment used in this retrieval and is referred to for further details.)

ERRORS:  
 SHIP-TO-SHORE  
 SHIP-TO-SMALL-BOAT  
 SMALL-BOAT-TO-SUB  
 SUB DEPTH

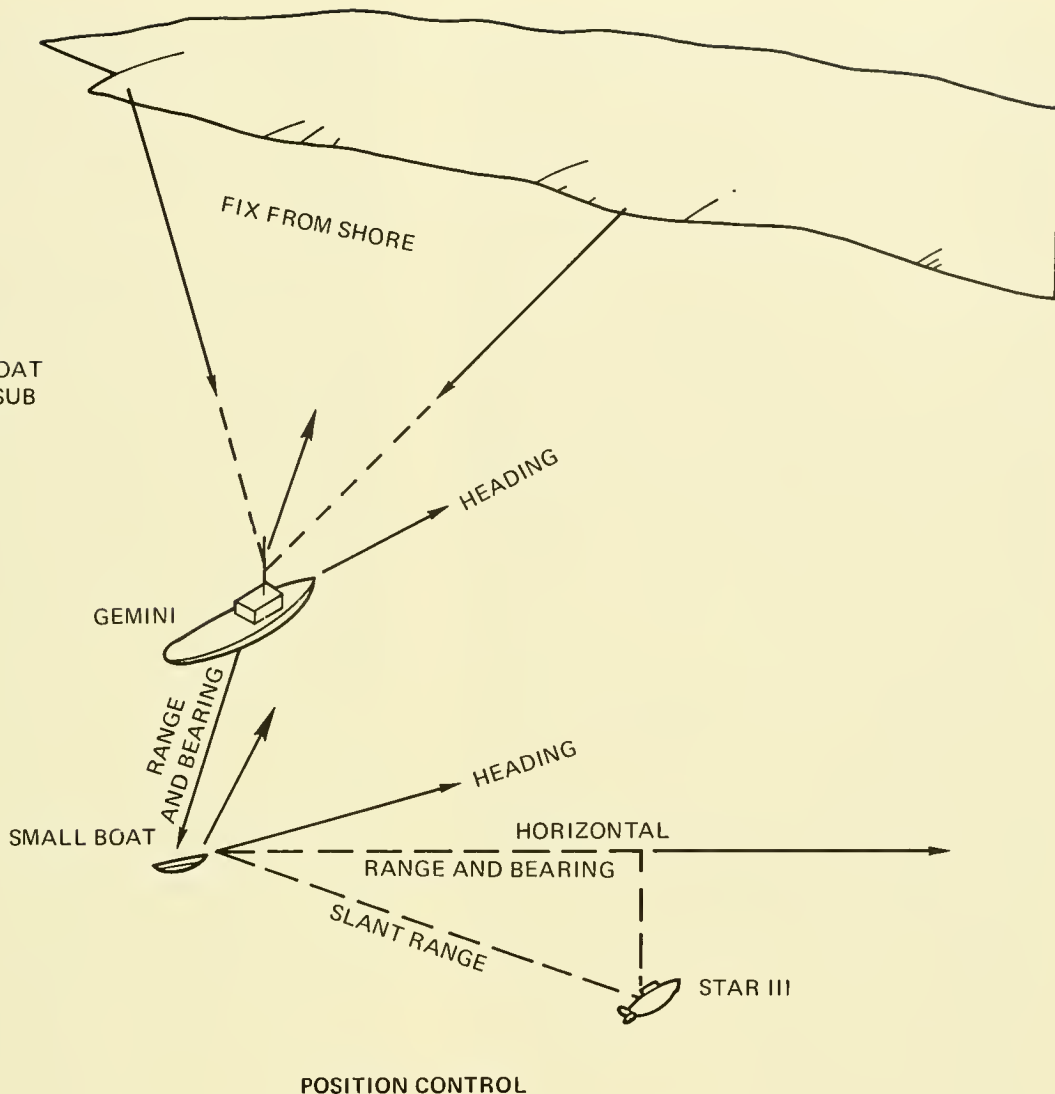

Fig. 10.16 STAR III's tracking and position control.

The lost array consisted of a 3,600-foot nylon line with a release mechanism and five current meters attached in tandem. The depth was 3,150 feet and the surface location had been accurately fixed by bearings on shore when the loss occurred. **ALUMINAUT** was equipped with a 37-kHz pinger (which produced relative bearings to a line hydrophone on the surface ship) and an underwater telephone to provide both range and communications. A CTFM Sonar on **ALUMI-**

**NAUT** was to be used to "home in" on another 37-kHz pinger which was dropped by the support ship (**PRIVATEER**) on the array's last fix and suspended off the bottom by a buoy.

Reaching the bottom at 3,200 feet **ALUMINAUT** was trimmed, given a course to the pinger by **PRIVATEER** and proceeded along on its wheels. At first, the CTFM sonar intermittently picked up the pinger but then lost the ability to train (rotate). The pilot was

obliged to turn *ALUMINAUT* 360 degrees in an attempt to locate the pinger; this was unsuccessful and *ALUMINAUT* then requested *PRIVATEER* to furnish a course to the pinger which it would follow with its gyrocompass. The array was found and it was followed to the original top current meter. On reaching the top meter, *ALUMINAUT* reversed course to follow and ascertain the array's configuration and determine whether or not the release mechanism had functioned. Periodic fixes were obtained on *ALUMINAUT* from the surface so that the array might be plotted and found again on the subsequent dive. The array was easily followed, and no trouble was experienced until the line turned at a right angle to its initial trend. At this point the bottom sloped abruptly to the left, and the current measured 0.4 knot. To follow the array line it was necessary to change course to starboard into the current which was setting on *ALUMINAUT*'s starboard side. The increased current would not allow the pilot to swing 90 degrees to the right and instead caused *ALUMINAUT* to drift to port away from the line. Visual contact was lost, and *ALUMINAUT* was forced to run with the current downslope until it gained sufficient speed to turn 180 degrees in a wide arc back into the current. Visual contact with the array line was re-established while stemming the current. Visibility, at 60 to 80 feet initially, had diminished to 30 feet at this point. Approximately 15 to 20 feet from the array anchor and release mechanism, the starboard shot ballast tank malfunctioned and dropped its shot, causing *ALUMINAUT* to lose negative buoyancy and to ascend gradually. To deter the loss of negative buoyancy the pilot stopped *ALUMINAUT* with the vertical thruster. When *ALUMINAUT* attempted to get underway again, it could not overcome the current, and was carried down-current again while slowly ascending. At this stage the vertical motor failed and the pilot was forced to drive ahead full with the stern propellers while attempting to put a down-angle on the bow with the diving planes. This was not successful, and all personnel moved to the bow in an attempt to increase the down-angle. This failed and *ALUMINAUT* finally surfaced without inspecting the release mechanism.

Prior to the second dive a retrieving spool

was installed, and to compensate for the southerly-setting current *ALUMINAUT* was towed 1/4 mile northeast of the array location and then commenced to dive statically (without power) with a southerly heading trying to pick up the 37-kHz marker pinger on the repaired CTFM.

Bottoming at 3,400 feet, *ALUMINAUT* trimmed and continued attempts to locate the pinger. Although the pinger was nearby during the descent, after reaching the bottom it was never heard from again. The subsequent 3 hours and 51 minutes were spent looking for the array by following courses given *ALUMINAUT* by *PRIVATEER*. Subsequent measurements of the positioning system showed that an error of at least 300 yards existed. A final solution was obtained by estimating the submersible's position through depth measurements and bottom slope directions communicated to the surface by the pilot.

*ALUMINAUT*'s progress was slowed considerably by the need to negotiate rock outcrops without use of the broken vertical motor. Objects on the CTFM and side scanning sonars also slowed progress for it was necessary to identify each of these objects. At one point tracks, suspected to be from *ALUMINAUT*'s previous dive, were discovered and followed until they finally disappeared.

While ascending up and over an uneven bottom slope, one of the submersible's passengers walked forward and caused a down-angle on the bow; this in turn caused the spool to strike the bottom and disengage from its carrying hook. Retrieving and replacing the spool on the hook consumed considerable time because of the decreased visibility caused by sediment stirred up by the manipulators.

Finally locating the array, *ALUMINAUT* attached the retrieval line and surfaced. At the surface the array was transferred from *ALUMINAUT* to *PRIVATEER* and recovered. *ALUMINAUT*'s problems in this retrieval contain all the elements that act to inhibit undersea search, survey and salvage. There is, however, one salient point to bear in mind: The array was recovered and not because of the tracking system but in spite of it.

There is a further aspect of this tracking

method that concerns safety. When the hydrophone is deployed from a small boat, it adds an element of risk, as well as further inaccuracies. In this context, reference is made to the **DS-2000** incident in Chapter 15 wherein the small boat, support ship and submersible all became separated with the onset of inclement weather.

### Pinger/Transponder (Sub)—Hydrophone/Interrogator (Surf):

The system described above requires the operator to actively participate in determining the vehicle's horizontal distance from the surface ship. First, he must respond with a "Mark" of his own so that the surface ship can compute slant range. Second, he must provide his depth which is also a necessary factor in slant range computations. A system designed for **BEN FRANKLIN's** 30-day drift provided all the necessary values with nothing required on the part of the submersible's operator. The system, designed by Martin Fagot of the Naval Oceanographic Office, is not necessarily the ultimate in surface tracking, but it is presented because it worked as designed for 30 days. Such reliability is rare in deep submergence.

The tracking system, described by Fagot and Merrifield (22), is shown in block diagram in Figure 10.17. The submersible's components consist of two independent subsystems: A pinger and a transponder. The support ship's components consist of a line hydrophone, two transducers, a graphic recorder and speaker, an oscilloscope and associated electronics.

**Pinger Subsystem** —The pinger (General Time Model No. 0B04A) is a self-powered acoustic generator that emits a 4-kHz pulse at a precise periodic rate of 1 pulse per 2 seconds. Every primary pulse, 10 ms in length, is followed by a secondary pulse, 2 ms in length. The pulse separation is pressure dependent and varies linearly from 20 to 400 milliseconds for pressures between 0 psi and 5,000 psi. The battery pack, a 12-volt magnesium dry cell, provides a signaling life of 2 months for primary and secondary pulse transmission.

The characteristics of the directional hydrophone (Weston - DT-171A) used to receive the pinger signal are as follows: Frequency range of 500 to 20,000 Hz; open circuit volt-

age sensitivity of 84 db below 1 volt per microbar; directional beam pattern in the horizontal plane, approximately 12 degrees at 3 db down for a 4-kHz signal; and a front to back sensitivity of 10 db as used in this operation. When information concerning the relative bearing to **BEN FRANKLIN** was not required, an omnidirectional hydrophone (Atlantic Research LC-50) was used instead of the directional transducer.

The output of each hydrophone was isolated, filtered and amplified before being displayed on the graphic recorder. The recorder was a Giffit model GDR-IC-19-T. Since scale was 200 fathoms for 2-way travel time, the distance represented by one sweep was 400 fathoms or 2,400 feet across the record. With

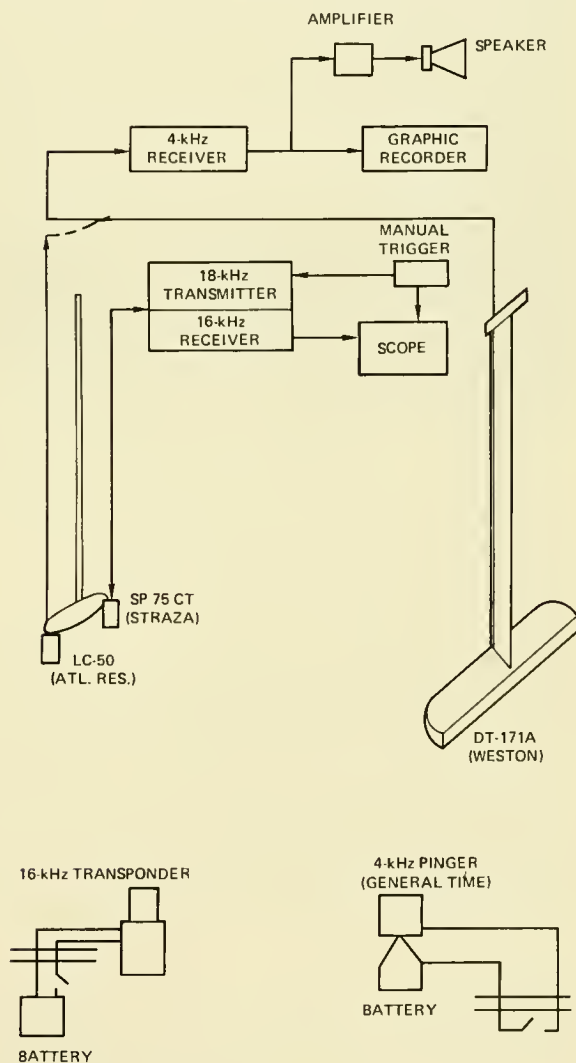

Fig. 10.17 Tracking system block diagram.

Mode Gain set at Xi and Gain set at mid-scale, total gain from the Giffit was about 40 db. Thus, with a maximum gain of 100 db from the amplifiers, total gain for receiver and recorder was 140 db. A speaker was installed at the hydrophone which allowed for aural reception of the pinger, and its strength predicated the direction of training.

**Transponder Subsystem** —Manufactured by Alpine Geophysical Associates, the transponder transmits at 16 kHz and receives at 18 kHz. The interrogating transducer (Straza SP75 CT) was located on the surface ship and had a transmitting sensitivity of +48 db at 18 kHz and a receiving sensitivity of -82 db at 16 kHz.

A transmitter was used in the subsystem to drive the Straza and was manually triggered at all times when updated slant range information was required. Although these transponder signals were not automatically recorded, they were displayed on an oscilloscope. The time delays on the oscilloscope were converted to slant ranges and manually noted on the graphic pinger record as required.

The general tracking procedure was for the support ship to steam upstream over **BEN FRANKLIN** to a slant range of about 5,000 feet. Here, the engines were idled and the ship drifted back over the submersible to 5,000 feet downcurrent and repeated the cycle. A photograph of the record displayed by the Giffit recorder is presented in Figure 10.18 and clearly shows the opening and closing of slant range to the submersible.

Fagot and Merrifield (*ibid.*) analyzed a variety of factors that influenced this system. It is interesting that the theoretical range of this tracking system was 25 miles, but only about 1 mile was ever realized at sea.

More recently, the Wesmar Scanning Sonar has been applied in surface tracking. By using the sonar from a surface ship to interrogate a transponder on the submersible, ranges and bearings are obtained and displayed to the surface controllers.

### **Short Base Line Systems:**

Of all the surface tracking systems, the short base line system, as termed by Rainnie (19), is the most accurate in determining the submersible's position relative to the support

craft. With an accurate surface positioning system, it can provide quite accurate geographic positioning and high order repeatability. The system was used in the 1966 Spanish bomb hunt with **USNS MIZAR** as the surface craft and was instrumental in the mission's success.

A base line, according to Bowditch, is the line between two transmitters (or receivers in this application) operating together to provide a line of position, or a line serving as the basis for measurement of other lines. The length of a base line should be at least one-fifth that of the average side of the principal network of lines of the survey or search area of interest. Accurate measurement of the base line is critical; the Naval Oceanographic Office specifies a maximum error of one part in 150,000 or about half an inch per nautical mile. Short or long is a relative term, but the length of the base line with **MIZAR** is less than the ship's length of 266 feet.

**MIZAR's** system consists of four hydrophones spaced at known locations on the hull and either a timed-pinger or a transponder on the submersible. Similar in principle to the acoustic tracking systems discussed, the difference resides in the measurement of the difference in arrival time of the signal at each hydrophone. From these differences the depth, range and bearing to the vehicle can be calculated. A general arrangement of this system is shown in Figure 10.19.

Rainnie (*ibid.*) lists several advantages of this system: There is no action required on the submersible's part; several vehicles can use the same system concurrently; it works best over the object or area of interest and looks mainly "down" which helps avoid shadow zones; and it is potentially one of the most accurate systems available. On the other hand, he cites the need for a large ship (*i.e.*, long base line), stabilized horizontal reference plane, stringent processing requirements, loss of tracking near the surface and bulkiness—all of which lead to a complex and expensive (\$0.5 million in 1971) system.

Excluding the Short Base Line System, all of the foregoing systems provide not much more than an indication of where the submersible is in relation to the surface craft. As we have seen from **ALUMINAUT's** experience, the one slant range and bearing posi-

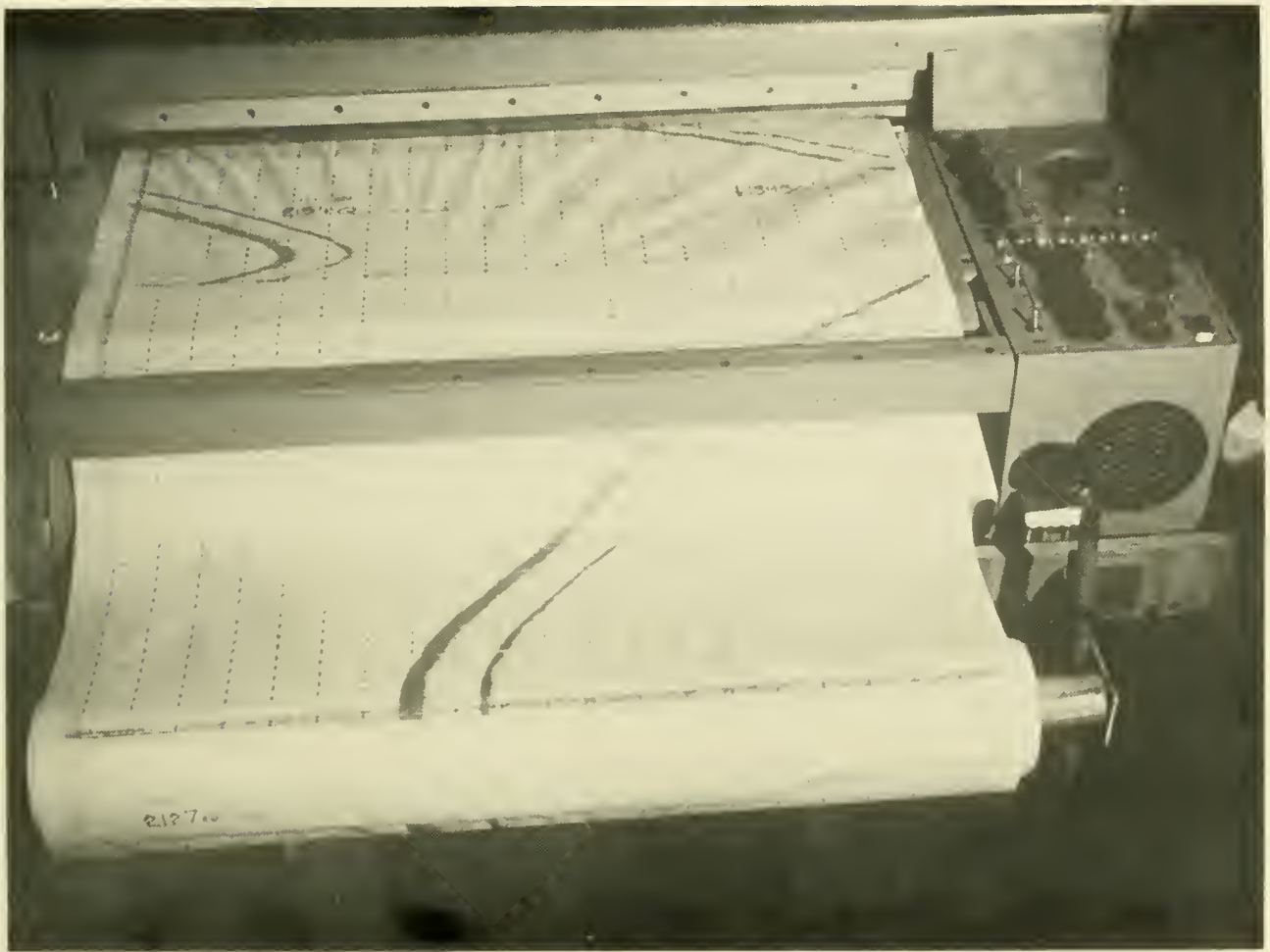

Fig 10.18 Giff recorder record of slant range from support ship *PRIVATEER* to *BEN FRANKLIN*. Range increases to right. The larger (thickest) trace is the primary pulse (slant range); the thinner trace is the secondary pulse which can be read to provide vehicle depth. (NAVOCEANO)

tion is fairly useless either as an accurate or a repeatable system. Even when the submersible is bottomed and stationary, multiple fixes on it from different positions produce position errors in the neighborhood of 200 to 300 yards (23). Since such surface acoustic tracking systems require an acoustic pinger on the submersible, however, they do provide a necessary safety feature desirable for surfacing and gross positioning in the event of a submerged emergency.

### Submerged Navigation

The title of this section should not be construed so as to infer independence from the

surface ship, because all of the following systems ultimately relate the submersible's track or location to positions established by and on the surface.

The schemes and systems in this category position the submersible either relative to undersea objects (both passive and active) or by dead reckoning. Their commonality resides in the fact that theoretically, they do not require course changes or directions from the surface once a reference marker or a "start" position has been established. The systems fall basically under Acoustic and Non-Acoustic approaches but overlapping of both is so common that such a distinction is

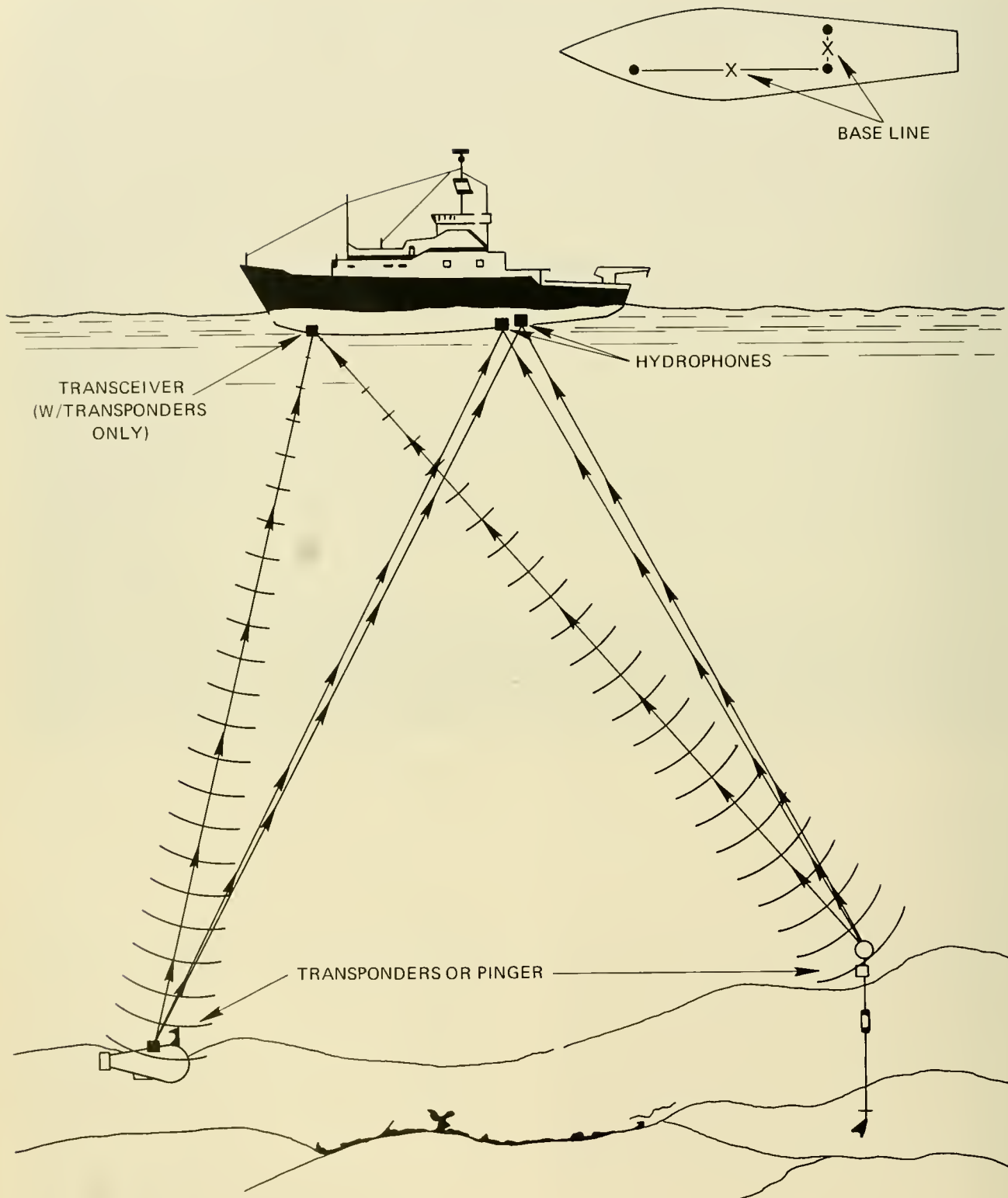

Fig. 10.19 Typical short base line acoustic navigation system. [From Ref. (19)]



unrealistic. Instead, the following discussion proceeds from the simplest to the more sophisticated.

#### **Visible Markers:**

During the *THRESHER* search *TRIESTE I* experienced great difficulty in obtaining reliable underwater positions to assure that a particular area had been searched and to prepare photographic montages. A method was evolved that consisted of laying individually numbered and color-coded plastic markers at intervals along the ocean floor to serve as visible landmarks (24). The markers were 17- × 21-inch plastic sheets which were rolled up and secured by rubber bands with ends held by magnesium wire. The markers were tied to 10-pound sash weights and dropped by a surface craft along designated tracks at 6-second intervals. Several factors limited the effectiveness of these "fortune cookies" (so called because they had to unroll in order to be read): The tracks and spacing for dropping could not be held constant, many "cookies" failed to unroll, and the effects of variable currents considerably changed the planned from actual landing spot. Although some 1,441 markers were dropped at about every 58 feet on an 11-line grid, as much as 2 hours might pass between *TRIESTE's* marker sightings. Admittedly an approach born from the lack of alternatives, after the *THRESHER* search the "fortune cookie" returned to its time-honored role of providing a chuckle instead of a fix.

#### **Dead Reckoning:**

Dead reckoning (DR) is the determination of position by advancing a known position from a knowledge of heading, speed, time and drift. It is reckoning relative to something stationary or "dead" in the water, and hence applies to courses and speeds through the water. Because of inadequate allowances for compass error, imperfect steering and/or error in measuring speed, the actual motion through the water is seldom determined with complete accuracy. In addition, if the water itself is in motion, the course and speed over the bottom differ from that through the water. Geographically, a dead reckoning position is an approximate one which is corrected from time to time as the opportunity is presented.

Dead reckoning systems used in submersibles all rely on a magnetic compass or a gyrocompass for course direction. Distance has been measured with a wheel, by estimates of speed/unit time and by Doppler sonar.

Every contemporary submersible lists either a magnetic compass or a gyrocompass (or both) in its onboard inventory. The former, in its simplest form, allows a free swinging and dipping magnet to align itself with the earth's magnetic field; the latter depends upon one or more north-seeking gyroscopes as the directive element(s) to indicate heading relative to true north. The construction and workings of the magnetic compass and the gyrocompass are discussed in Bowditch (15) in great detail and nothing more can be added to clarify the subject herein. The use of either compass to follow a specific course is inordinately simple: The vehicle is turned until the appropriate bearing matches a lubber line (a mark on the inside surface of the compass bowl which indicates forward direction parallel to the longitudinal centerline) and proceeds forward on this course. A number of submersibles have repeaters which are a part of a remote indicating system that repeats the indications of the master compass or gyrocompass. Magnesium repeaters are quite frequently used, and the entire system (master and slave) is referred to as a Magnesium compass. These require an AC power source and generally include a small DC-AC inverter.

**Magnetic Compass** —The magnetic compass is simple, rugged, reliable and requires no electric power, but it has serious limitations in submersibles. Since it responds to the net local magnetic field, a steel hull, a wrench, iron ballast, bars or shot, magnetic tape recorder, external instruments, internal recorders, pocket knives, keys or electrical conductors near the compass can influence its reading. In most submersibles it is difficult, if not impossible, not to be near the compass. For this and a host of other reasons, navigating by magnetic compass is fraught with the potential for error. Because it is so widely employed, one would expect that its application in submersibles would have been thoroughly researched and studied, but, like the lead-acid battery, reports or articles dealing

with submersible navigation primarily discuss what could be and not what is: Hence, the magnetic compass is simply specified and then ignored. Specific guidelines for the compass are difficult to provide owing to the diversity of influences in individual vehicles. One might benefit, nevertheless, by checking its accuracy once the vehicle is completely outfitted and ready to dive. Subsequent rearrangement of components or outfitting of new instruments should be followed by further rechecking. Furthermore, geographic location, magnetic storms and local magnetic anomalies within the earth call for frequent rechecking.

A typical local magnetic anomaly might be an offshore oil rig. John Newman of Perry Submarine Builders relates that magnetic compass readings were all but useless in a North Sea diving operation because the vehicle was operating in close proximity to a drilling platform. At one point the submersible had inadvertently collided with the platform; wishing to clear the area, the vehicle turned 180 degrees from its collision course and proceeded only 10 feet before it collided with the same rig once again. Obviously, navigation by some means other than magnetic compasses should be considered in undersea pipeline or hardware inspections.

**Gyrocompass** —Since the gyrocompass is not affected by a magnetic field, it is subject to none of the magnetic errors of the magnetic compass, and it is not useless near the earth's magnetic poles. Errors which are present are the same on all headings. On the other hand, a gyrocompass requires a suitable source of electrical (AC) power and if power is interrupted, a period of time (up to 4 hr in some cases) is required for it to stabilize. It is complex and requires more maintenance than a magnetic compass. The gyrocompass is also subject to several systematic errors (*e.g.*, precession) which can be eliminated or offset in the design or can be manually adjusted to correct. According to Bowditch, the gyro error of modern compasses is generally so small that it can be ignored, but errors can be introduced which make frequent checking a good practice.

Several commercially available gyroscopes are used in submersibles. Figure 10.20 shows the *Sperry MK 27* and its repeater used

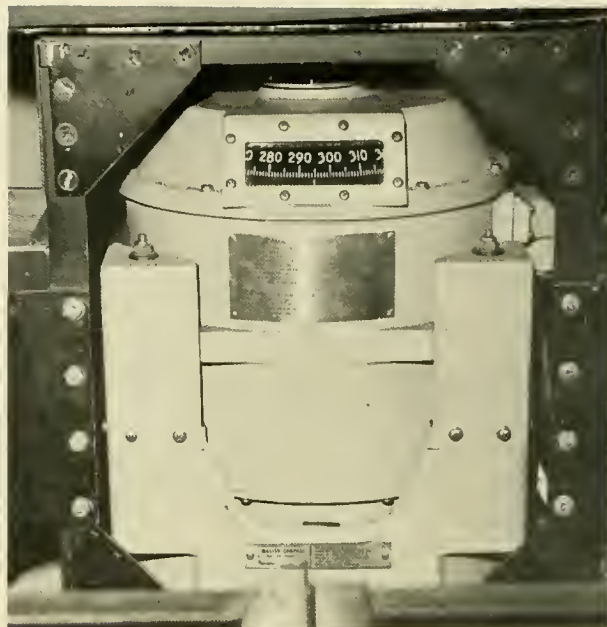

Fig 10.20 A Sperry MK27 Gyrocompass aboard DS-2000 located aft beneath the observers seat. The repeater for this unit (inset) is installed forward on the instrument panel.

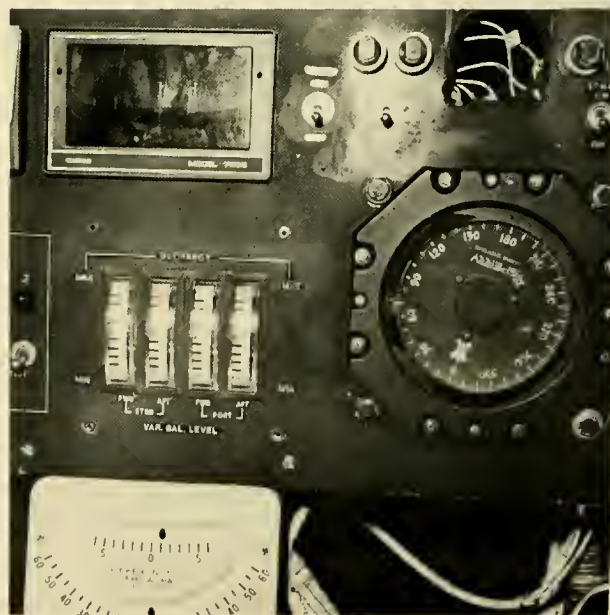

Fig. 10.20 (inset)

aboard *DS-2000*. Almost all are adopted from aircraft designs because of their light weight and small size. One of the smallest is R. C. Allen's Electronic Direction Indicator used aboard *PC-14* and *PC-9 (TS-1)* and shown in Figure 10.21. This unit is about the size of a tennis ball can and may be mounted directly on an instrument panel. Preliminary tests, however, showed a drift rate of some 8 to 9 degrees in 2 hours. It is not clear whether the instrument finally stabilized or would have continued its precession, or whether it was being affected by the submersible's (*PC-9*) electronics. Regardless, once the steady-state drift rate has been definitely established, it is possible to compensate for it and maneuver accordingly.

A few vehicles use both a magnetic compass and a gyrocompass. Both *SEA CLIFF* and *TURTLE* use a gyrocompass as the primary direction indicator and a Magnesyn compass as a backup indicator. To reduce the influence of the submersible's magnetic hull, the master compass (called a "transmitter") is mounted outside the hull in a pressure compensated container. The repeater (indica-



Fig. 10.22 To reduce the interfering effects of the hull on its magnetic compass, *SHELF DIVER*'s compass is mounted off of the conning tower in the bubble-like protrusion

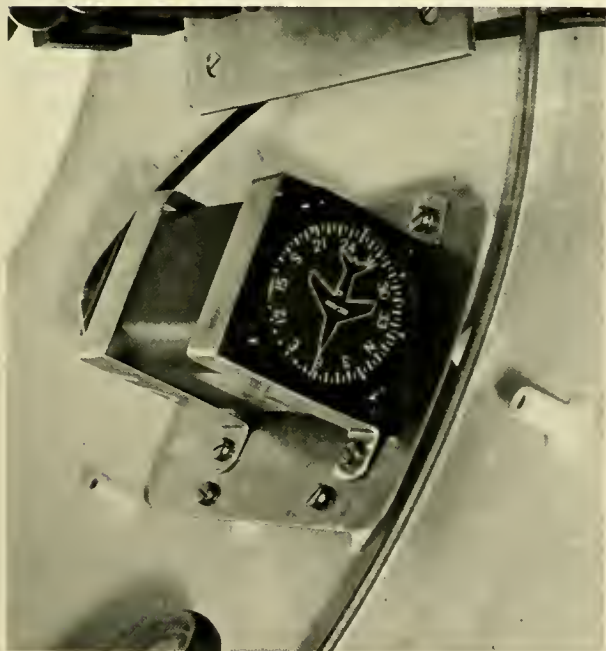

Fig. 10.21 An R. C. Allen electronic direction indicator aboard *PC-14*.

tor) is mounted on the operator's panel and is shielded to prevent magnetic interference. Locating the transmitter external to the pressure hull is not original to the Navy's submersibles; Perry's *SHELF DIVER* (Fig. 10.22) and others follow the same procedure.

Also adopted from the aircraft industry is the directional gyro used aboard *SDL-1*. The directional gyro is essentially a gyroscope pointed in a desired direction which it maintains for some period of time. Its primary purpose is to permit the operator to steer a relatively straight line. The drift rate of *SDL-1*'s directional gyro is approximately 1 degree per hour and, hence, it is not intended for extended dead reckoning.

Generally, a dead reckoning position is obtained by starting at some known point (determined by the surface ship) and carrying this point along a course, the direction of which is given by the compass or gyrocompass, the distance derived from speed  $\times$  time. The potential for error in this approach has been discussed. Currents, instrument errors,

operator errors and time errors are the greatest adversaries. Even if we assume that all of these errors are zero and that no currents are present, the speed of most submersibles is rarely precisely known and this leads to a larger error which accumulates with distance traveled. No point is served in further belaboring the inadequacies of this approach. In the final analysis it is so full of unknowns that to consider it as more than a gross position approximation would be a mistake. Two other DR systems, which do not rely on vehicular speed, are the Unigator and Doppler Sonar. The former has limited application; the latter is rapidly becoming a quite useful tool.

**The Unigator** —The Unigator (unicycle-navigator) is merely a weighted bicycle wheel suspended on a rod which the submersible tows over the bottom (Fig. 10.23). An odometer cable is attached to the wheel and the odometer display is mounted externally on a viewport. Used in conjunction with the vehicle's compass or gyrocompass, the odometer measures distance traveled along a particu-

lar bearing. The Unigator has a major shortcoming: It measures every undulation of the bottom. Hence, on all but a flat bottom, the wheel provides a distance in excess of that actually traveled on a straight path. There are quite a few flat ocean areas where distance measurements by the wheel would be quite accurate. If, for example, a submersible were inspecting a submarine cable, the length of cable inspected, as measured by the wheel, would be as accurate as any method in existence (providing the bottom was flat or gently rolling). Additionally, the Unigator serves a function similar to that of the bathyscaph's guide chain. Once the vehicle is trimmed to a point where it is being held to the bottom only by the weight of the wheel, no further adjustments are required to keep it at a constant altitude. The designers of this method relate the details of its construction and operation in reference (25). Significantly, they report a test run along a triangle of 0.1 nm length on each side which resulted in the submersible (*PC-3B*) being offset by only 25 feet from its starting position (a buoy). The error was attributed to currents exceeding 1 knot which swept the test area and displaced the submersible. As a geographic positioner, the Unigator offers far less errors than "fortune cookies" and is probably better than dead reckoning by speed-time estimates. Under the proper conditions it is probably as good as any in existence, and undoubtedly one of the least expensive to measure bottom distance.

**Doppler Sonar** —The Doppler principle of speed measurement is based on the fact that a signal transmitted from a moving object and reflected from a stable surface is shifted in frequency proportional to the speed of the object in relation to the surface. In Doppler Navigators, sonic beams from a moving submersible are directed at the bottom and are reflected back at a frequency which differs from the transmitted frequency. The Doppler unit measures the speed directly by detecting and quantifying this frequency shift. On surface ships pitch, roll and heave, however, add another apparent motion with respect to the bottom. To cancel out this effect, present Doppler sonar models employ two pairs of beams instead of one. A pair of beams is angled fore and aft, and another pair angled



Fig 10.23 The Unigator

port and starboard. If the ship's motion is forward, the frequency shift of the beam angled forward will be positive and the one angled aft negative. The difference between the two return frequencies produces speed readings which average out the effects of the pitch of the ship in the water. Each beam is angled from the vertical and is narrow (approximately 3° wide).

The receiving unit contains four receiving hydrophones, also similarly angled and resonant at the same nominal frequency. Speeds fore-aft and athwartship are measured independently to read the true velocity components of the ship's motion, and thus the ship's actual speed and drift angle. Integrating speed over a period of time provides a reading of distance traveled over the bottom. Pitch, roll and heave, unless purposefully done, are usually not a problem submerged, but drift due to currents—which can equal or even exceed the submersible's speed—is an important factor in maintaining a desired course. To satisfy the drift problem, the current Doppler systems not only sense drift, but display it in such a fashion that the operator may compensate for it to follow a specific track over the bottom.

Doppler sonar has been employed for some time in the docking and piloting of merchant ships. It was only in the late sixties that it became available for deep submersibles. The U.S. Navy performed tests with a General Applied Science Laboratory JANUS series Doppler navigator on board *ALUMINAUT* in 1968 (26), and as a part of this work Sperry Rand Corp. performed both laboratory and field tests on the same Doppler models. The tests showed promise and prompted Sperry to produce its model SRD-101 Doppler Navigator, the transducer of which is shown on *JOHNSON SEA LINK* in Figure 10.24. A thorough account of its development, design and testing is contained in reference (27).

The SRD-101 operates on a frequency of 400 kHz. Because of high acoustic absorption at this frequency, it is limited to operations no more than 250 feet off the bottom and not closer than 4 feet to the bottom. Kritz (*ibid.*) points out that a basic accuracy limitation in heading reference resides in the fact that virtually all Doppler systems rely on either a magnetic compass or gyrocompass. To

achieve a 1/2 percent (of heading) accuracy a heading input from either source accurate to 1/4 degree is required. He further comments that small gyrocompasses of the type suitable for submersibles do not provide the necessary accuracy. At 1-degree accuracy neither do magnetic compasses.

In spite of these limitations several vehicles (e.g., *TRIESTE*, *DEEP QUEST*, *PC-9*, *DSRV-1 & 2*) employ a Doppler system; one of these, *DEEP QUEST*, feeds the Doppler output into an x-y plotter which provides a real-time, continuous trace of the vehicle's course. No published accounts of the Doppler sonar's use under operational conditions are available, but personal communications with Mr. Roger Cook, Field Operations Manager and Chief Pilot of the *JOHNSON SEA LINK*, revealed that the SRD-101 has done all the manufacturer said it would and has shown 100-percent reliability—a rare feat in deep submergence. Undoubtedly, for dead reckoning the Doppler system is superior to any others now in use. But, remember: While the distance of the line traversed is accurate to within 1 percent of the distance traveled, the geographic position of the beginning and end of the line is still extrapolated from the

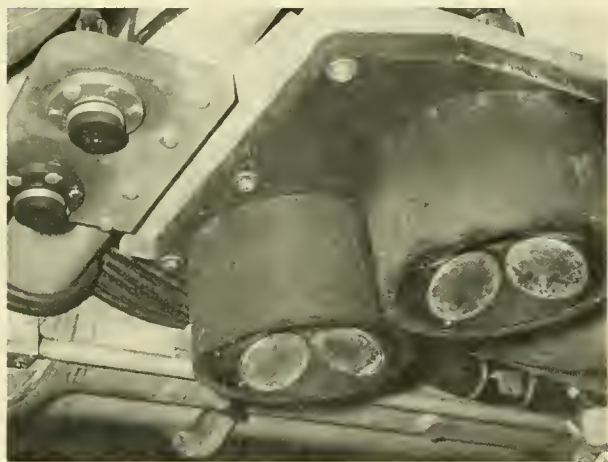

Fig. 10.24 Doppler sonar transducers (right) aboard *JOHNSON SEA LINK*. The two smaller transducers to the left are for the downward-looking echo sounder and are not a part of the Doppler system.

surface and inextricably bound to the surface positions' inaccuracies.

### **Bottom-Mounted Acoustic Systems:**

The most discussed and promising schemes for underwater navigation are systems which employ bottom-mounted acoustic beacons of precisely known position to provide near-continuous range and bearing data to the submersible. From this information an onboard processor displays and/or records the vehicle's relative position in real-time. The instruments and techniques used in this approach are varied, but the concept is quite simple and employs either pingers or transponders.

Any number of bottom markers may be used, but three is the preferred minimal amount because the intersection of three range vectors from three known positions provides a triangle of error by which the accuracy of the fix may be measured. A strong attraction of this system is that repeatability can be theoretically within the underwater range of viewing by the human eye (approximately 30 feet) and the operator can return time and again to the same location as long as the marker network remains functional. Either pingers or transponders may be used. Rather than use hypothetical examples of this system, two actual operations have been documented and serve as good examples of the variations of this technique.

**Timed-Pingers** —In 1967 *ALVIN* discovered an F6F aircraft at 5,543 feet; an expedition was undertaken to relocate the aircraft the following year using timed pingers for on-site navigation.

*ALVIN*'s initial position at the aircraft relative to the surface ship (*LULU*) was obtained by using a tracking system. *LULU* obtained its own position (directly over *ALVIN*) with Loran A to a geographic accuracy of  $\pm 1$  mile. Hence, a circle of 2 miles in diameter was established at the search area. *ALVIN* also obtained a depth reading at the wreckage site accurate to within  $\pm 20$  feet. (The source of this data is reference (28) which relates in detail the many considerations of the relocation approach, most of which are not repeated here.)

The operation plan envisioned dropping

two timed-pingers upslope of the aircraft on the 5,250-foot contour and navigate relative to them.

The heart of the timed-pinger system is a master clock on the submersible which is synchronized with acoustic transmitters on the beacons before deployment and thenceforth serves as the time standard. The two beacons transmit a pulse (one at 4 kHz; the other at 5 kHz) at the same instant and the arrival times of these pulses are measured by *ALVIN*, processed and displayed digitally and graphically as slant ranges from submersible-to-pinger. A knowledge of the water sound velocity is required to obtain the optimum accuracy, as well as an extremely accurate master clock.

The first beacon was dropped by *LULU* at positions obtained by Loran A and echo sounder depths. The second beacon was dropped at a pre-determined slant range obtained from the first and a surface-obtained echo sounder depth. The resultant base line distance between the two pingers was 5,180 feet. *ALVIN* subsequently dived and obtained a depth reading on each and, alternately, a range from one to the other. The submersible then conducted its search along a depth contour (1,709 decibars), obtaining its position from the pingers. A reconstruction of *ALVIN*'s track during this operation is presented in Figure 10.25. Adding to the system's accuracy, a sound velocity meter was carried by *ALVIN* to measure the local area structure.

Comparing the timed-pingers to transponders (discussed in the following section) Rainnie (19) lists these advantages of this system: Any number of vehicles may use it concurrently; the one way acoustic path decreases inaccuracies due to sound speed variations; electronic "decision making" procedures in the pinger are not required; ambient noise has no effect and the circuitry is simple. Rainnie also lists such disadvantages as higher energy (power) requirements and degradation of accuracy with time.

**Transponders** —This system follows the same format as the foregoing, the important exception being that the submersible must interrogate (command) the transponder to obtain a range. The primary equipments are an interrogator (generally a CTFM sonar),

F6F AIRCRAFT INSPECTION  
ALVIN TRACK  
DIVE 302  
24 SEPT. 1968  
DEPTH: 1,690 M

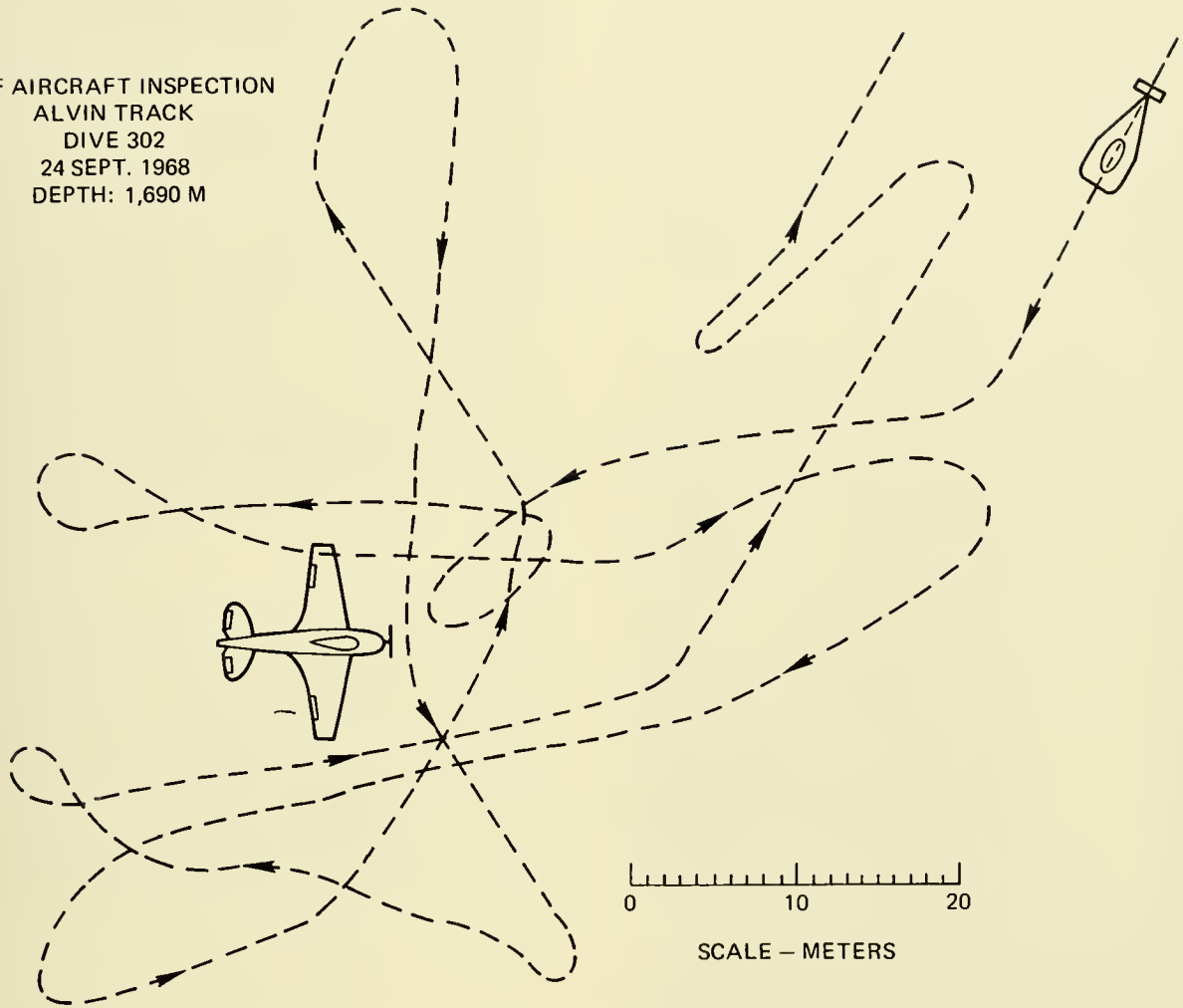

Fig. 10.25 ALVIN's track during F6F aircraft inspection. [From Ref. (28)]

which sends out its command on one frequency; transponders, which receive the interrogation signal and respond back to the submersible on different frequencies; and a receiver with the associated inboard equipment necessary to acquire and process the transponder signals and convert them to range from the submersible. For greatest accuracy a sound velocity meter is required

to obtain the local sound structure. In operation, periodic fixes are obtained as the vehicle proceeds within the transponder net. A further refinement involves plotting the submersible's track on an x-y plotter.

A transponder approach was employed by *TRIESTE II* during the search for the *SCORPION* in 1969. Although the results of this operation, from a navigational point of view,

were less than anticipated, the approach and instruments are fairly representative of this system and are described in reference (29).

**TRIESTE II's** interrogator consisted of a transducer which transmitted a 7-kHz signal and a receiver capable of receiving 10 replies at frequencies between 12.5 and 17 kHz. The interrogator receives, processes and digitally displays three preselected frequencies as slant ranges to the bathyscaph. The depth of this operation was 12,000 feet and an area  $500 \times 800$  feet was to be covered.

The plan envisioned three ships simultaneously dropping three transponders buoyed a short distance off the bottom to form an equilateral triangle. **TRIESTE II** was then to twice cross each line (base line) between the transponders to establish the distance between the three as pictured in Figure 10.26. Having established the dimensions of the net and the relative bearings of one transponder to the other, the bathyscaph would then begin a controlled search interrogating on 7 kHz and receiving on 14.5, 15.5 and 16.5 kHz. In addition to the input from the transponder interrogation system (called TIP), data from a pressure transducer, Doppler sonar and gyrocompass were also fed into a computer which then allowed the bathyscaph's progress to be displayed on an x-y plotter.

This approach is the optimum for a transponder system, but as so often happens in the actual at-sea phase—the results were quite different than anticipated. First, the transponders were not dropped simultaneously. Next, only two out of the three worked at first, which required the dropping of a fourth. The subsequent operations over a 6-week period consisted of on-again, off-again transponder reception. In the final analysis, **TRIESTE** was forced to use the one working transponder and gyrocompass headings to maneuver itself into the prime search area, and then to navigate by use of **SCORPION's** debris.

**TRIESTE II's** experience sums up the advantages and disadvantages of bottom-mounted acoustic systems probably better than any other means: Operationally, the potential is yet to be realized. This is not to say that transponders or timed-pingers do not work. **ALVIN's** aircraft search went off

flawlessly, and transponder positioning systems have worked perfectly in other applications. But there are exceptions, and far more often than not system complexity and the dependence on so many factors result in partial success. For these reasons contemporary industrial operators of submersibles have shied away from this approach. Another factor is cost; a commercial CTFM sonar costs some \$50,000, a transponder with its acoustic release mechanism (necessary for retrieval) is about \$5,000. Consequently, the initial outlay in funds for a three-transponder system with all the attendant electronics and processors can run to almost half the cost of a small, shallow-diving submersible—an example being the **PC-14** which cost Texas A&M University approximately \$145 thousand.

### Homing

The term "homing" simply means going to a specific location or an object. All of the navigation schemes discussed in the preceding sections can be used to home in or direct the submersible to an object, site or whatever. In many instances it is not necessary to know the geographic location, but merely to find or reacquire the item of interest. There are a variety of instruments and approaches

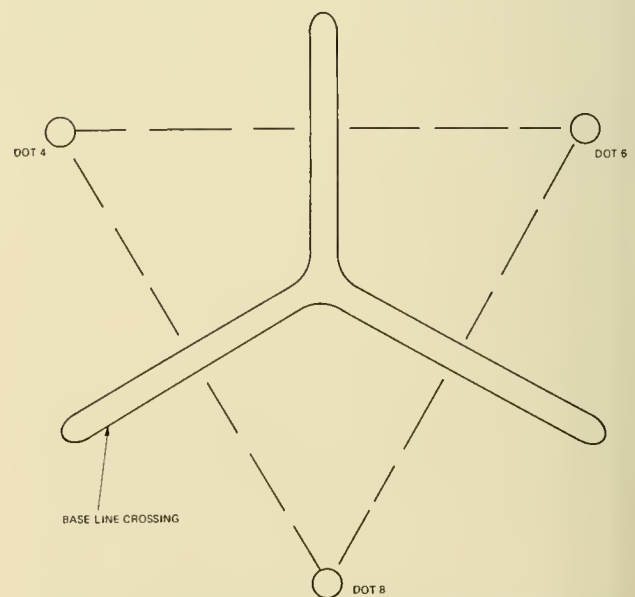

Fig. 10.26 Transponder (DOT) grid and base line crossings as originally planned for **TRIESTE II's** **SCORPION** operations. [From Ref. (29)]



to assist the operator in homing. At times the very simplest means have been used—*e.g.*, following the marks or trail the submersible left in the sediment on a previous dive, following a cable or visually tracking a trail or pattern of debris, as did *TRIESTE II* in the *SCORPION* operations. On the other hand, the target itself may produce a scour mark which may be used for homing—*e.g.*, the H-bomb lost off Spain. In this situation, *ALVIN* followed a likely looking trail which led directly to the bomb. Often there are no alternatives to such homing methods, but there are other more dependable approaches which are commercially available and offer better performance than mere chance or serendipity. These are: Marker buoys and passive and active sonar targets.

#### Marker Buoys:

The simplest homing system is an anchored buoy line which either the submersible or surface ship plants at the desired location. The concept is deceptively simple: The operator needs only to follow the line down to the anchor. But, limited water visibility, restricted submersible viewing capability, currents and limited maneuvering ability all may work individually or together to thwart this most fundamental approach. Furthermore, adverse weather can move the buoy and its anchor or simply tear it loose. In reality, this method serves mainly as a visual aid to positioning the surface ship and, subsequently, the submersible, once it is in close approximation to the undersea target.

Obviously, there are many methods of planting a buoy, the time-honored one being simply to lower an anchored line to the bottom and buoying it off on the surface. The drawback to this method is that the ship drifts off the chosen site while the anchor is being lowered. A more exact and quicker approach is offered in the Helle "Call Buoy" (Fig. 10.27).

#### Passive and Active Acoustic Targets:

The most successful homing devices utilize acoustics either 1) passively, by pinging off a sound reflecting object and determining its bearing relative to the submersible (range is not necessarily important, but may be desirable), or 2) actively, by a) receiving and clos-

ing in on a ping emitted from the target or b) interrogating a transponder which marks the target and homing in on it from the range and bearing data thus obtained.

The arrangement and deployment of reflectors, pingers and transponders vary according to the vehicle's onboard capabilities and the nature of the task. Deployment of these devices may be from the surface ship or from the submersible itself. The devices may be used individually, or they may be combined into an array as shown in Figure

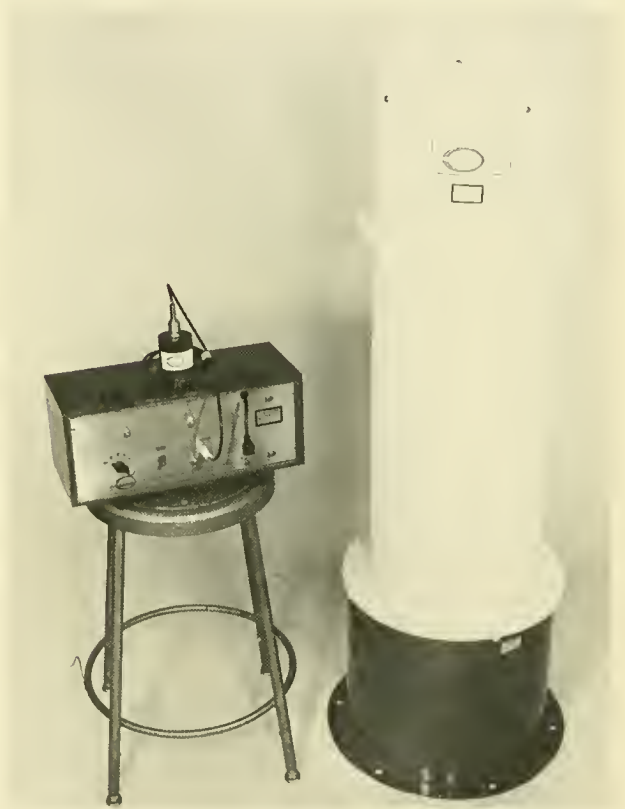

Fig. 10.27 The Helle "Call Buoy." The cylinder on the right is dropped over the side and sinks to the bottom. For up to 3 years after installation, a coded release signal from the command module (left) will cause the cylinder to separate and a buoy to rise to the surface while unreeling a cable. The Call Buoy is presently available with 700 ft of cable. (Helle Engineering Inc.)

10.28. In this example the array is ship-deployed and consists of an anchor, a release mechanism, a sonar reflector, a pinger or a transponder, a connecting cable and a buoyancy element to hold the array at a desired level off the bottom. To use this method (Fig. 10.28) as a homing device, the submersible must have a transmitter/receiver (transceiver) for the transponder, a receiver for using only the pinger or a transducer for the sonar reflector. The information required by the operator to close with the array can be in several forms: Range and/or bearing displayed as a "blip" on a CRT with which the operator visually closes; an audible tone emitted by a speaker and which is loudest when the vehicle is oriented directly toward the sound source; or a pair of sonic-activated lights, one of which blinks to indicate direction to the sound source. On CTFM sonars and some others, both audible and visible displays are provided. The audible display is

handy, in that the operator need not take his eyes from the viewport or TV monitor to obtain direction. To release the array from its anchor for subsequent surface retrieval a submersible would require a manipulator or some grasping/pulling device to release the pull-pin in Figure 10.28. A further refinement, quite helpful in visual detection, is a flashing light which can be detected for some distance in the absence of natural sunlight or the submersible's artificial light sources.

The sources and nature of these components are quite numerous and varied. The trade-offs inherent in the choice of different operating frequencies are the same as those encountered in the selection of an underwater telephone: Low frequency provides greater range with decreased resolution; higher frequency provides shorter ranges with increased resolution.

Illustrative of the devices used in homing (and navigation as well) are those developed by the *ALVIN* Group at Woods Hole during the late sixties. These are thoroughly described in reference (30), and the following examples are taken from it and reference (23).

**Acoustic Reflectors** —A Tri-plane acoustic reflector (Fig. 10.29) was developed by WHOI for ranging and homing out to 600 yards on a frequency of 72 to 82 kHz. The steel plates are  $\frac{1}{8}$ -inch thick and the geometric design of the Tri-plane provides sufficient flat surfaces to reflect a major portion of the acoustic pulse. The disadvantages of reflectors are that line-of-sight conditions must exist and back-scatter from hilly terrain in the area may completely mask the reflector's return. Field tests with *ALVIN* in 1966 produced usable reflections from 1 ft<sup>2</sup> reflectors of this type to ranges of 230 yards with the submersible 10 feet off the bottom. Visual range to the reflectors (under artificial light) was from 10 to 20 yards. In some cases reflecting tape on the Tri-planes produced visual ranges of 30 to 50 yards.

The Benthos Corp. supplies a hollow glass sphere capable of withstanding virtually any ocean depth. Such spheres are better sonic reflectors than are steel plates, and a battery-powered flashing light inside the sphere offers better visual contact than does reflecting tape. Benthos' spheres and lights were

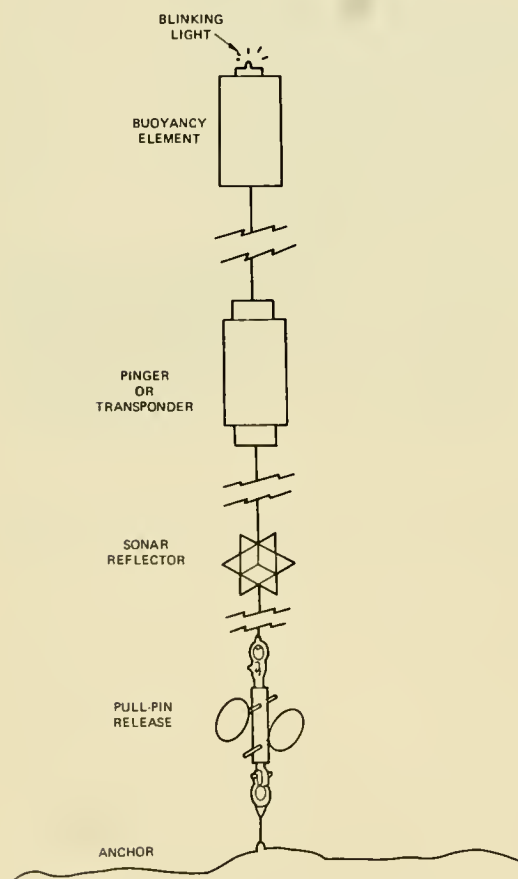

Fig 10.28 Elements of a hypothetical homing array. [From Ref (30)]

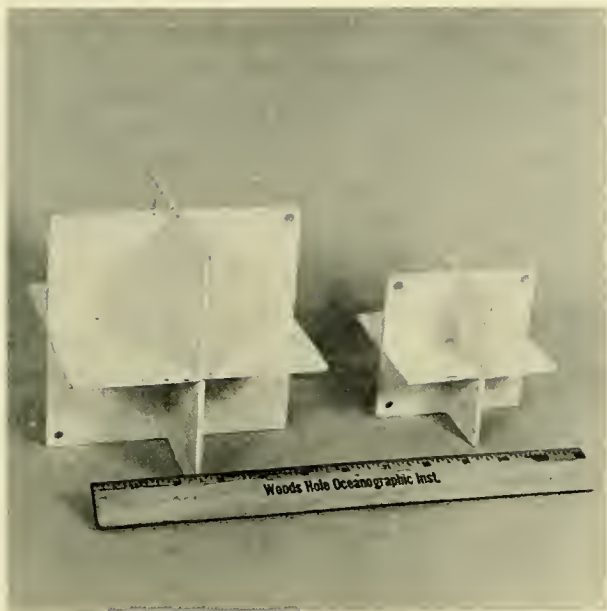

Fig. 10.29 Tri-plane steel acoustic reflector. (WHOI)

used experimentally (23) and the flashing light was clearly visible at 310 feet with *ALVIN's* lights off and dimly visible at 175 feet with lights on.

Virtually anything that will reflect sound sufficiently to produce a return with a favorable signal-to-noise ratio will serve as a passive marker. In a 1969 search for an aircraft's flight data recorder package at 350 feet deep, the tail section of the crashed plane was used as a central navigation marker for *DEEP QUEST's* search of the area as well as a point on which the vehicle homed from the surface to commence the search (31).

**Pingers** —Acoustic pingers can be dropped by the submersible or the surface ship. In the former case, it would serve to mark a specific point on a survey (or search) line to which the vehicle would return and continue the survey, or it might mark the location of an object to which the vehicle would return for retrieval. Figure 10.30 shows a solenoid-actuated pinger release mechanism and a 37-kHz salt-water activated pinger which will

not begin operating until it is dropped. To drop the pinger the solenoid is energized; this draws the plunger into it and causes the latch arm to move about the pivot. The movement of the latch arm draws out the latch pin and releases the pinger. The coiled spring assists in releasing the pinger. No electrical power is required to hold the pinger, only to release it.

For quick deployment of a pinger from the surface, WHOI developed the free-fall bottom

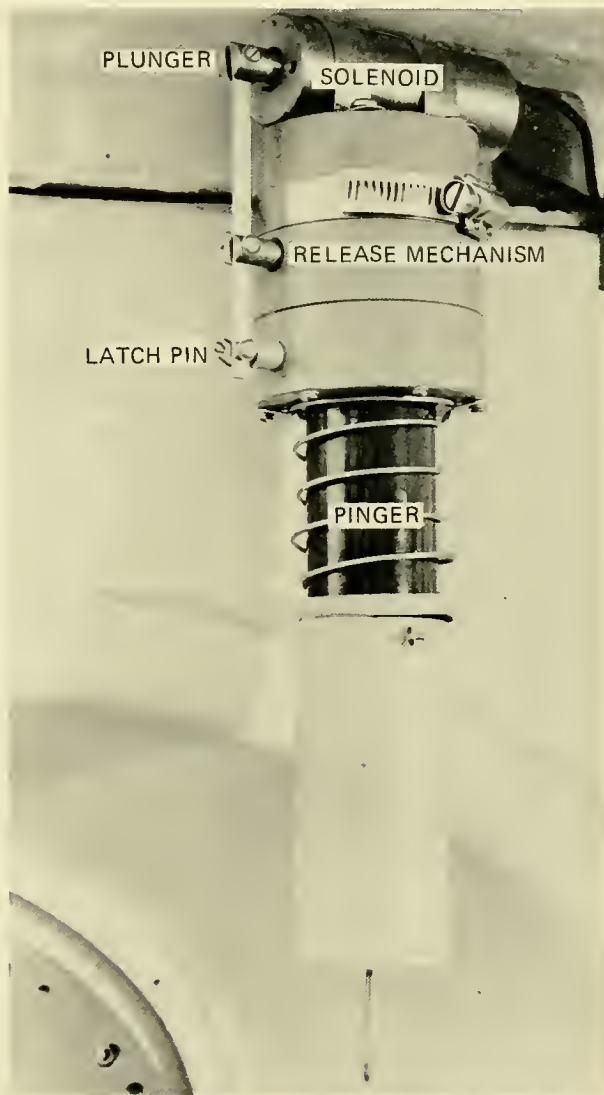

Fig. 10.30 A "salt-water" activated pinger and solenoid release mechanism on *ALVIN*. (WHOI)

marker (Fig. 10.31). The marker consists of an anchor, 125 feet of  $\frac{3}{16}$ -inch nylon line, a syntactic foam float, a 37-kHz pinger and a stabilizing fin which is attached to the float and encloses the pinger. The stabilizing fin also serves as a passive sonar reflector as well as restricting the free-fall velocity. A cross-sectional drawing of the marker is shown in Figure 10.32. As the marker descends, increasing water pressure collapses the bellows (restrained at one end by a retainer clamp) and the detent plunger retracts and slides free, allowing the retainer balls to fall into the cavity left by the detent pinger, thereupon unlocking the ball cage from the float assembly. Once separated, the

float assembly trails behind the nose cone. The plunger pin serves as a backup for the mechanical release of the ball detent separation assembly. On contact with the bottom the pin contacts the bellows causing it to collapse and release the ball detent lock. The particular pinger in this assembly operates on 37 kHz and emits a 25-millisecond pulse every 700 milliseconds for 21 days.

The effective range of such pingers varies considerably. In a 1966 test (23) *ALVIN* was able to acquire the 37-kHz signal at 4,500-foot range; greater distance might be attainable under ideal conditions.

Reception of the pinger's signal is by a simple hydrophone-like device or directional

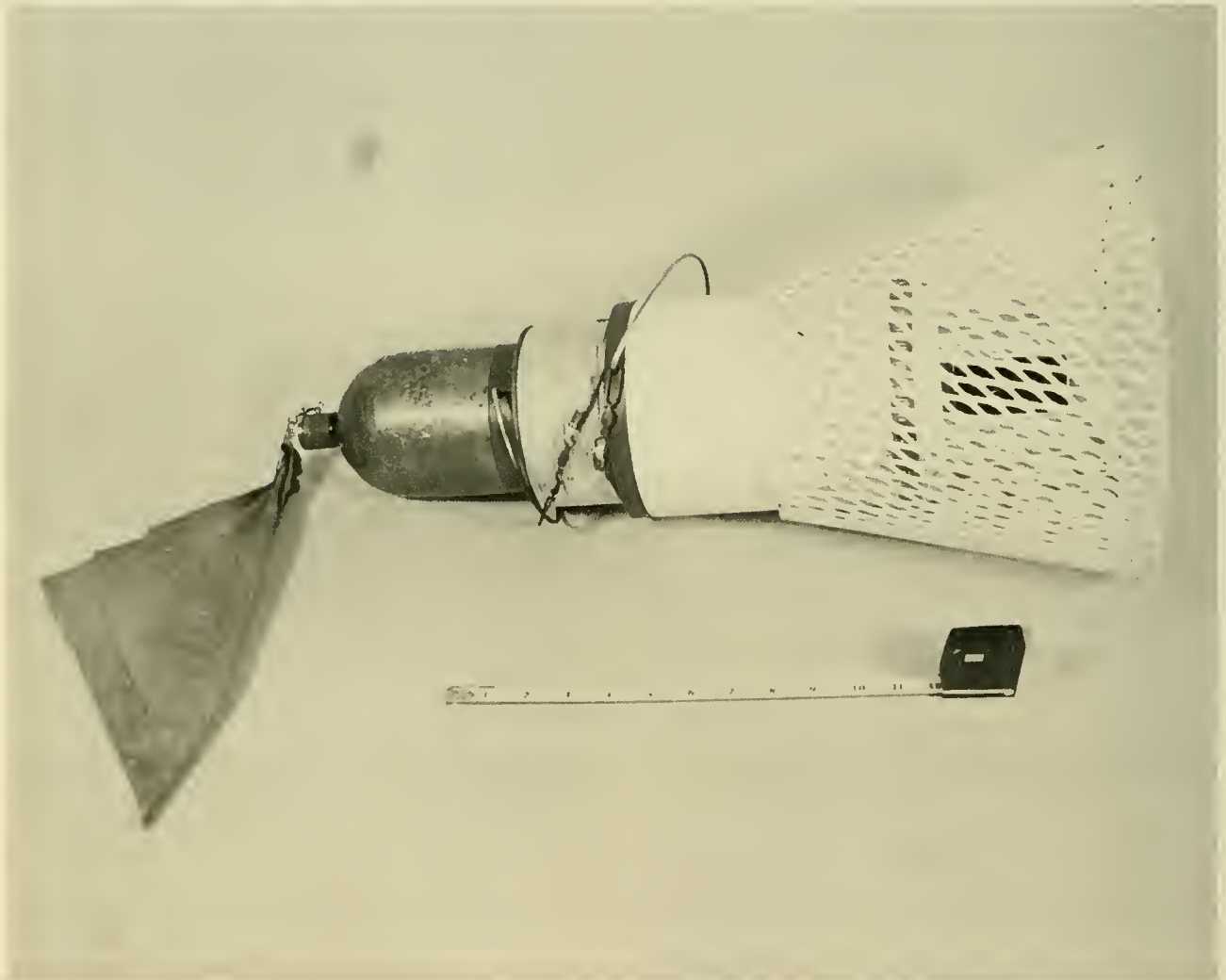

Fig. 10.31 Free-fall bottom marker. (WHOI)

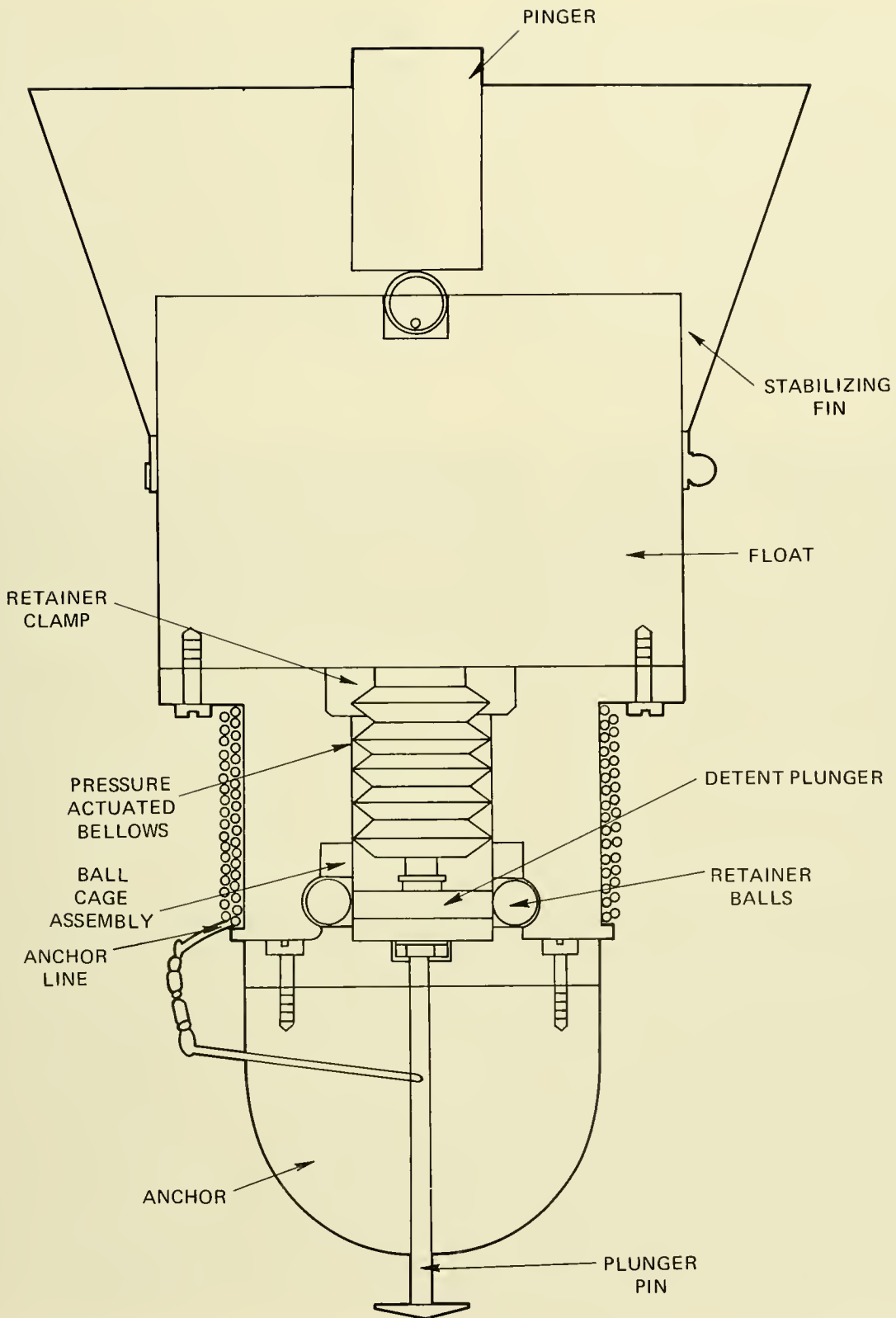

Fig. 10.32 Cross section free-fall bottom marker. [From Ref. (30)]

antenna attached to the vehicle's bow which activates an audible signal when it is pointing in the direction of the pinger. A commercially available model of Helle's Pinger-Receiver (Model 6550) is attached to **DS-2000** in Figure 10.33. The Helle unit is tunable through 25 to 40 kHz, it is lightweight and can be either self- or vehicle-powered.

**Transponders** —Transponders offer more exacting information, but they carry a price several orders of magnitude higher than that of a pinger. The cost is sufficiently high (about \$5,000) to warrant their retrieval, whereas the pinger in the free-fall marker is

considered expendable. Consequently, when using transponders one must include a release mechanism (to sever the transponder from its anchor) and budget some time for subsequent retrieval. Also, the use of a transponder requires a transmitter and a receiver, whereas the pinger needs only a receiver. For such reasons the use of transponders as simple homing beacons has been spotty. The advantages of a transponder are longer operating life, longer-range reception and range and bearing to the target instead of bearing only. In addition to being a homing beacon, the transponder can also be used

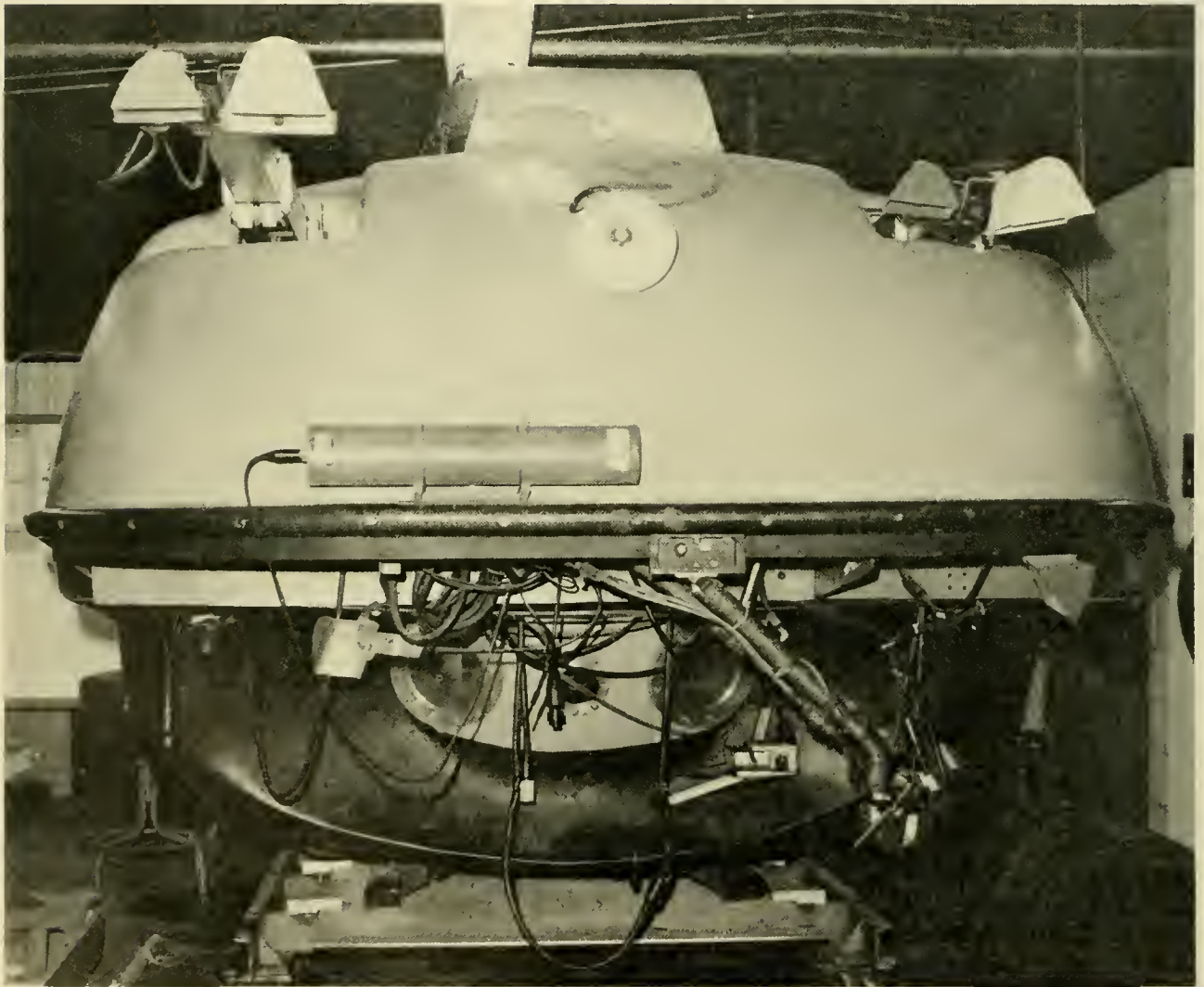

Fig 10.33 DS-2000 with a Helle Engineering pinger-receiver on its bow for acquiring and homing in on a beacon transmitting at any frequency between 25 and 40 kHz. An extendable light boom is above the receiver.

as a fairly accurate relative local positioning reference for search or survey operations.

Underwater release mechanisms are available which can be operated remotely by acoustic command or set to release on signal from an internal clock or by dissolution of a highly corrodable restraining material (e.g., magnesium). A variety of such devices has been successfully developed for surface operations. The submersible, however, has the distinct advantage of being on-the-scene, and a simple pull-pin release mechanism, such as shown in Figure 10.34, works quite well. Withdrawing either one of the two pull rings will separate the array line from its anchor and allow the transponder or pinger to float to the surface. Sole reliance on mechanical release mechanisms of the pull-pin variety is not recommended for a number of reasons, e.g., vehicle breakdown, homing beacon malfunction and the possible inability of the submersible to return or even find the array. The prudent engineer would do well to consider including one of the remote or self-actuating devices as an additional component of the array.

The foregoing discussion has been brief and simplistic and is quite different from actual at-sea experience with undersea navigation devices. On an individual basis, each pertinent navigation component aboard the submersible and in the homing device may work perfectly in the laboratory, but, when they all must work in concert and in the ocean, the most straight-forward and seemingly foolproof concept can become a nightmare of frustration. This is especially true when trying to set up and navigate by a pattern of bottom-mounted transponders or pingers. With the passage of time and a background of thwarted, frustrating efforts, a normally rational human being will, at times, find himself thinking of these inanimate devices as capricious, mischievous spirits. In essence, one does not "simply" do anything undersea, and just when the human and non-human components are operating well, the ocean itself may take the opportunity to display its ultimate control. Mr. Robert Worthington, Operations Manager of the *DEEP QUEST* system, rather nicely described the problem, "The ideal conditions, although frequently existing in nature, sel-

dom seem to occur when most desired." The point is: Anticipate the worst and stand by with alternatives.

## MANIPULATORS

The manipulators on a submersible are the operator's hands and arms, and, in the final analysis, the ultimate manipulator is one that equals dexterity and control of an actual human arm and hand. However, this is a difficult order to fill. H. A. Ballinger (32) aptly described the difficulty:

*"Consider, for example, the seemingly simple process of quietly closing a door. The hand proceeds through three dimensions in space to reach and grasp the door knob. It must then describe a true arc, which is parallel to the plane of the floor and centered on the door hinges. As the door approaches closure, the rates of the integrated movement must be selectively diminished, and a rotary motion applied to the door knob through a changing axis angle. At the right moment when visual, auditory, and force feed-back confirm, the knob is released. All these actions require a constant feed-back and assessment of data and appropriate motive adjustment—quite out of proportion to the apparent simplicity of the operation."*

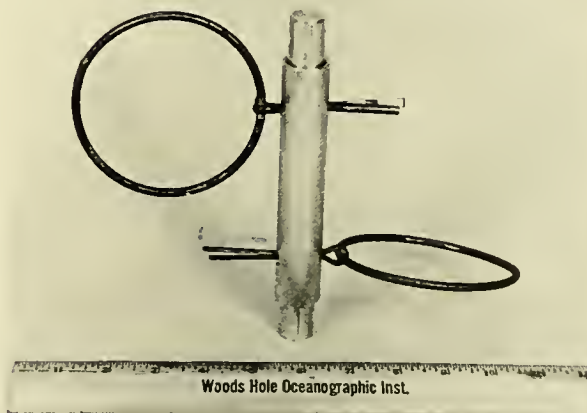

Fig. 10.34 Pull-pin release mechanism. (WHOI)

Manipulators represent man's attempt at duplicating his ability to grasp, hold, position, orient, actuate, push or pull. Consequently, the terminology describing manipulators and the manipulators themselves are patterned after the human arm and hand. *ALVIN's* manipulator is shown in Figure 10.35 and serves to introduce the terminology describing major components and the movements this particular manipulator can perform.

In an excellent summary of manipulator principles and capabilities, P. K. Rockwell (33) divides the motions of a manipulator into location and orientation. Location is defined as positioning the terminal end (claw) at any spot in the x, y and z axes. Orientation refers to placing the claw in any attitude requiring rotation about the x, y and z axes. Hence, six basic motions, or degrees of freedom, are required to fulfill these three location and three orientation capabilities (Fig. 10.36).

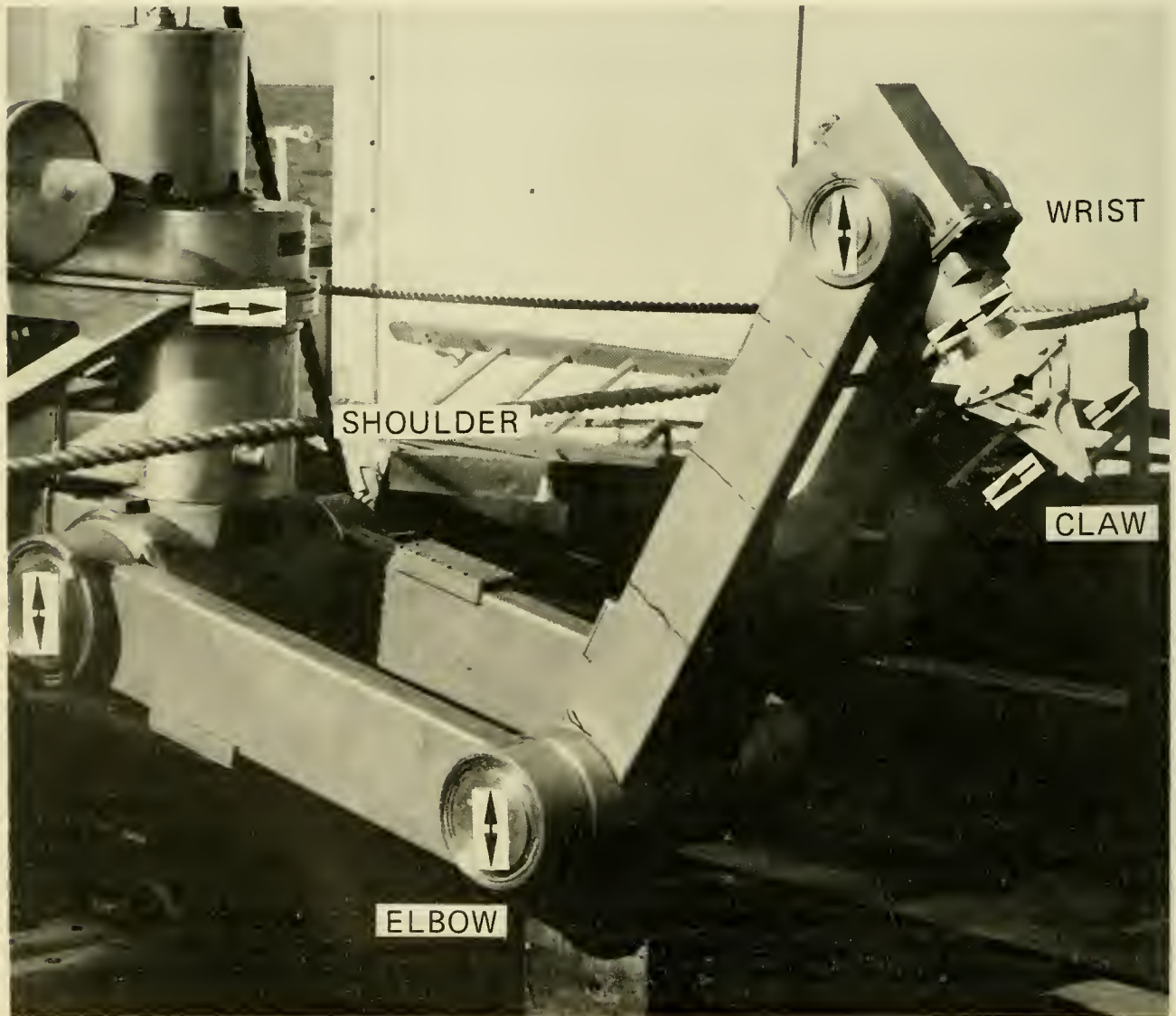

Fig. 10.35 *ALVIN's* manipulator. The arrows describe the movement at various junctures. (NAVOCEANO)



Two more degrees of freedom must be included: Grasping and linear movement; the former is an obvious motion, the latter is not. If one desires to push an object straight ahead, the elbow and shoulder must pivot at the same angular rate if the forearm is to remain in the same horizontal plane. *ALVIN*'s "joints" and all others as well, can only function one at a time, hence a linear extension of the wrist must be provided to push or pull in the same plane as the forearm. Figure 10.37 graphically illustrates the problem and its solution.

In Barringer's door-closing example, the arm went through a progressively diminishing rate of speed. This is another desirable feature in a manipulator: Variable speed control. Most manipulators, however, operate at only one speed.

A further characteristic of the human arm is that it tells the "operator" what force to apply. Such force "feedback" is nonexistent in contemporary submersible arms, but it is sometimes quite desirable. As an example, in 1966 *ALUMINAUT* was operating off the coast of St. Croix, Virgin Islands. A biologist on one particular dive was quite anxious to collect (intact) one of the many sea urchins inhabiting the bottom. *ALUMINAUT*'s manipulator has no force feedback or variable speed control. Hence, each attempt to pick up one of the delicate animals resulted in nothing more than a few fragments of spines or exoskeleton. Much to the biologist's consternation, the task was finally abandoned.

Obviously there are other components and requirements that must be present or satisfied if the manipulator is to do its work.

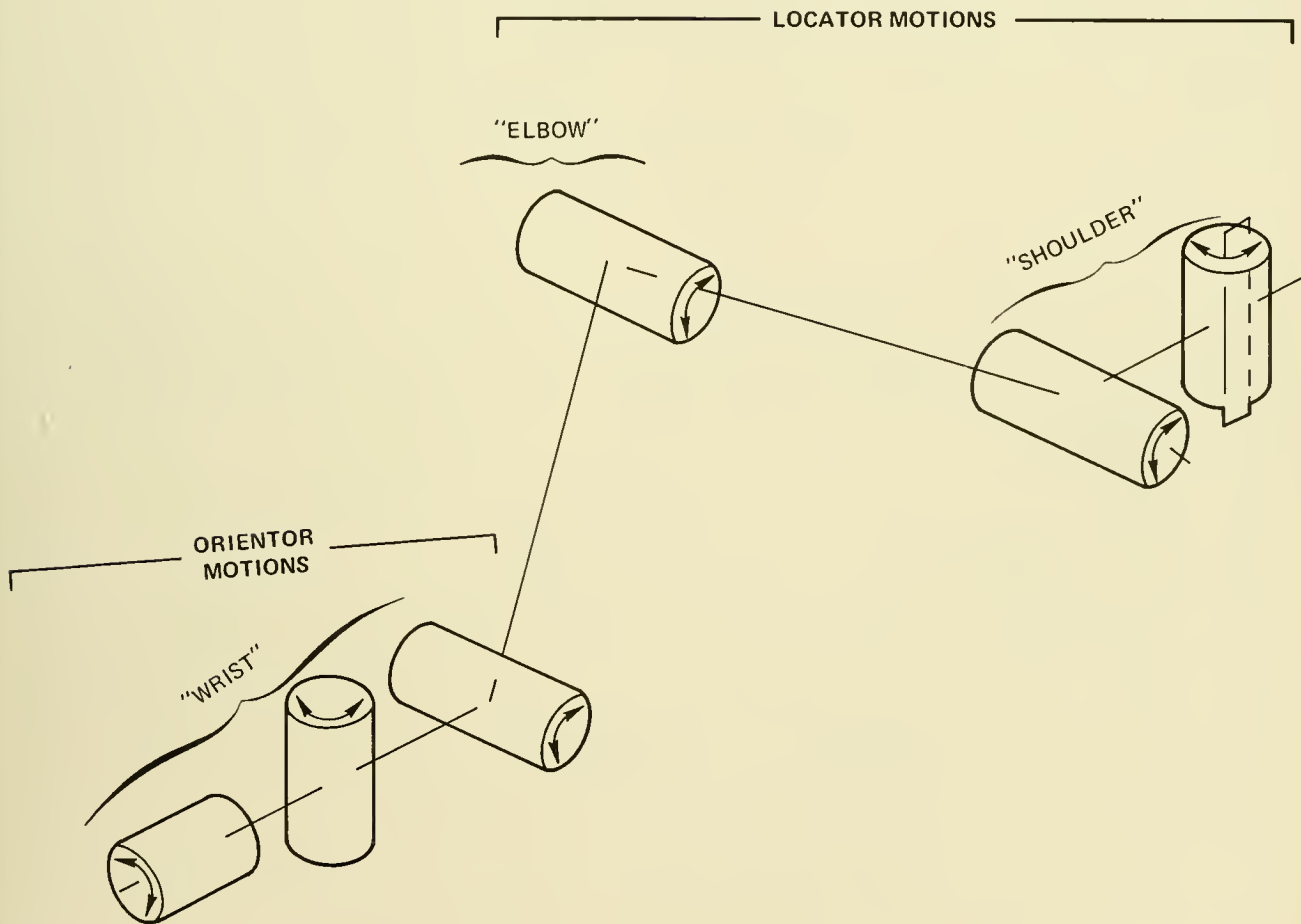
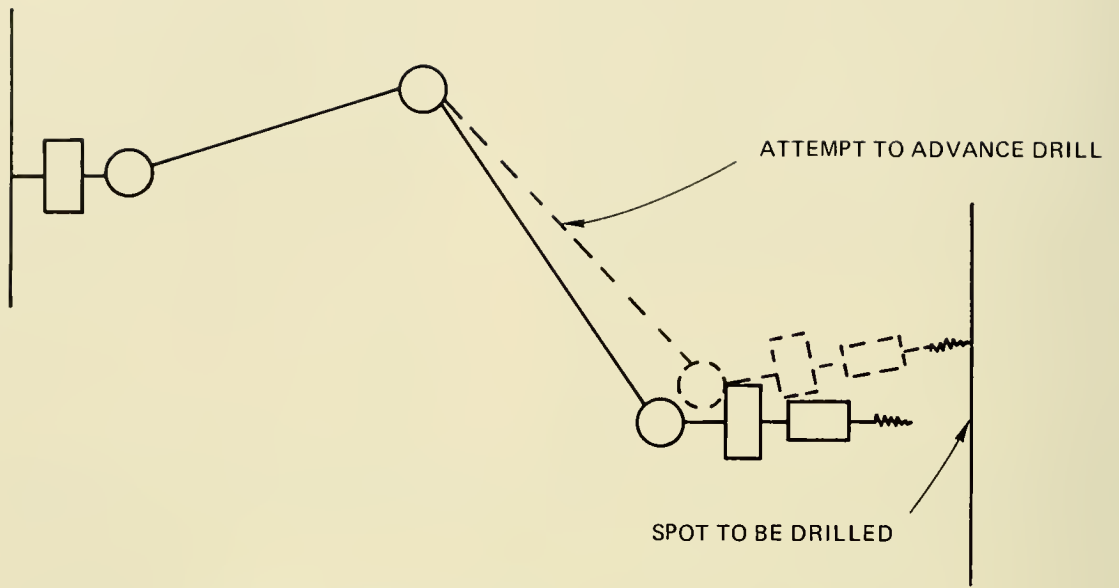
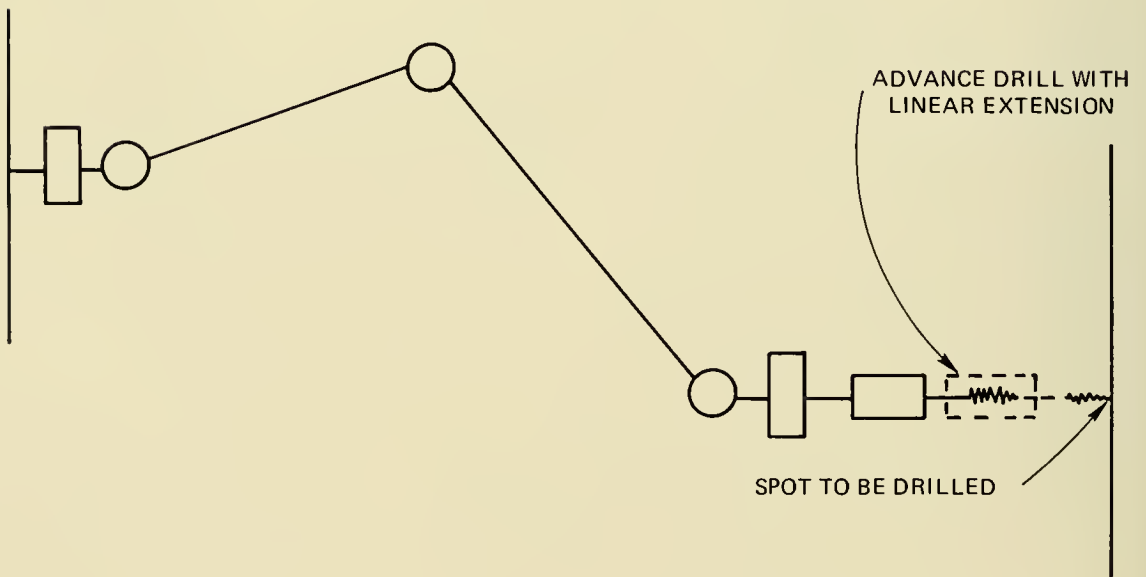

Fig. 10.36 Manipulator with six degrees of freedom. [From Ref. (33)]



a. WITHOUT LINEAR EXTENSION



b. WITH LINEAR EXTENSION

Fig. 10.37 Advancing a drill bit without (a) and with (b) linear extension. [From Ref. (33)]

Rockwell (*ibid.*) provides a chart which includes these and their relationship to each other (Fig. 10.38). To limit this discussion, it is assumed that a man and a work object are present and that the man can see the object. Our concern will concentrate on power, the manipulator, the claw or grasping device and control. The basis for this discussion is Table 10.8 which presents characteristics of manipulators on a variety of submersibles. This table is rather sketchy but is accurate insofar as manufacturers' brochures and operating manuals allow. To the researcher's distress, a great number of submersible owners state the fact that manipulators are present, but do not list the capabilities in other than broad terms; hence, the many NA (Not Available) annotations.

K. B. Wilson (34) states that a "true" manipulator can locate and orient its terminal device in any position within its coverage volume, and devices with less ability should be classed as special machines rather than manipulators. If many of the submersibles which have manipulators were required to remain fixed in one spot, their "manipula-

tors" would become special machines by Wilson's definition. But the ability of submersibles to do everything but operate upside down increases the capability of even the simplest "machines" to locate and orient the terminal device both within and without its area of fixed coverage volume. Consequently, Wilson's strict definition is not rigidly applied.

### Power

Electric motors and hydraulic pumps are the prime suppliers of manipulator movement. If the motors are external to the pressure hull they are subject to the same environmental constraints as propulsion motors, and the solutions and trade-offs of AC versus DC are similar. In the case of *SEA OTTER*, a manually operated pump within the hull pushes hydraulic fluid through the hull to activate its manipulator. *NEKTON's* manipulator obtains all of its motivation directly from the human occupant who actuates the arm from within the pressure hull. *JIM*, on the other hand, is a human arm within a

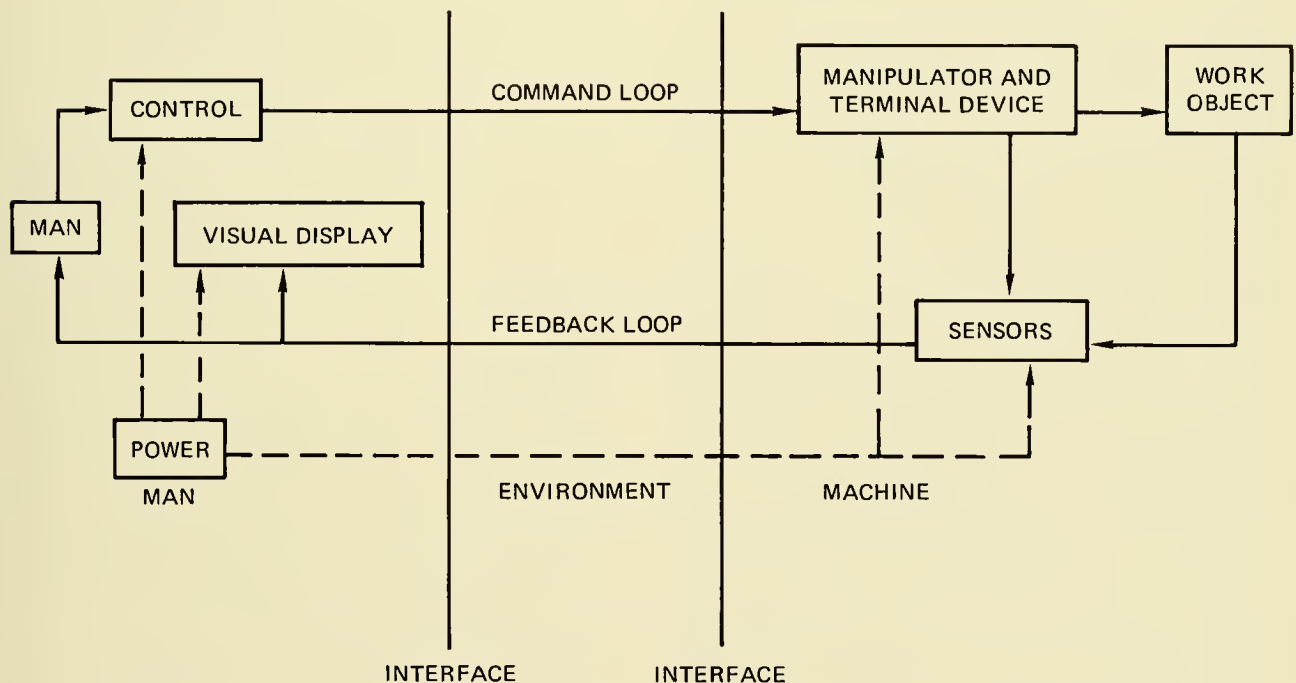

Fig. 10.38 Functional relationships in a manned submersible manipulator system. [From Ref. (33)]

TABLE 10.8 SUBMERSIBLE MANIPULATOR CHARACTERISTICS

Vehicle	Number of Manipulators	Degrees of Freedom	Claw Type	Power	Reach (Max.)	Lift Cap. Full Extension	Weight In Air	Jettisoning Method	Manufacturer	Remarks
ALUMINAUT	2	6	Parallel Jaw	Electro-Hydraulic	9 ft 1 in.	200 lb	NA*	None	Gen. Elec.	
ALVIN	1	6	Parallel Jaw Scissor	Electro-Mechanical	5 ft 3 in.	50 lb	438 lb	Solenoid operated trigger pin	Gen. Mills	
AQUARIUS	1	6	Scissor	Electro-Hydraulic	6 ft 1 in.	150 lb	150 lb	Jettisonable, no details	HYCO	Variable speed control
ARIES										
BEAVER	2	8	Hook	Electro-Hydraulic	9 ft	50 lb	150 lb (ea)	Hydraulic disconnect, electrical guillotines, mechanical disconnect	North Amer. Rockwell	Variable speed control Various work tool terminations
DEEP QUEST	2	7	Parallel Jaw	Electro-Hydraulic	5 ft	100 lb	NA	Jettisonable	Lockheed	
OS-2000										
OS-4000	1	3	Orange Peel	Electro-Hydraulic	3 ft 6 in.	35 lb		Jettisonable	Westinghouse	
SP-350										
SP-3000										
ODWB	1	6	Scissor	Electro-Mechanical	4 ft 1 in.	50 lb	185 lb	Jettisonable	Gen. Mtrs.	
OSRV-1&2	1	7	Parallel Jaw	Electro-Hydraulic	6 ft 8 in.	50 lb		Hydraulically jettisonable by normal or emergency means	Lockheed	
HAKUYO	1	5	Parallel Jaws	Electro-Hydraulic	4 ft	22 lb	220 lb	Jettisonable, no detail	NA	Adjustable grasping force
JIM	2	8+	Simulated fingers	Manual	approximately 3 ft.	NA	—	None	Underwater Marine Equip., Ltd.	Human arm in a jointed, pressure-resistant enclosure
NEKTON	1	8	Scissor	Manual	3 ft 2 in.	NA	NA	None	General Oceanographics	A manually powered and directed rod with claw pushed pulled or twisted in a thru-hull penetration
NEREID	1	4+	Parallel Jaw	Electro-Hydraulic	15 ft	2,500 lb	NA	NA	Nereid nv, Holland	A smaller manipulator is used for delicate tasks and is attached to the larger one
PC-8	1	3	Parallel Jaw	Electro-Hydraulic	6 ft 4 in.	300 lb	NA	None	Perry Sub. Bldrs.	If hydraulics fail control valves can be opened to permit seawater flooding of arm. Pressure will open jaws and retract arm
PISCES series	Articulated Arm	6	Parallel Jaw	Electro-Hydraulic	5 ft 6 in.	150 lb	150 lb	Manual hydraulic pressure	HYCO	Can be fitted with a variety of hand tools
& SDL-1	Clamping Arm	3	Circular Clamp	Electro-Hydraulic	NA	2000 lb	NA	Hydraulic, quick release	HYCO	Used for torpedo recovery
SEA CLIFF & TURTLE	2	7	Parallel Jaw Circular Clamp	Electro-Hydraulic	7 ft 1½ in.	100 lb	NA	Mechanical	Gen. Dyn.	Equipped with tools
SEA OTTER	1	1	Various	Manual Hydraulic	2 ft 6 in.	NA	NA	None	Arctic Marine Ltd	Vehicle also has a "BEAVER TYPE" manipulator capable of all its functions. It is not installed

TABLE 10.8 SUBMERSIBLE MANIPULATOR CHARACTERISTICS (Cont.)

Vehicle	Number of Manipulators	Degrees of Freedom	Claw Type	Power	Reach (Max.)	Lift Cap. Full Extension	Weight In Air	Jettisoning Method	Manufacturer	Remarks
SEA RANGER	2	6	Hook type	Electro-Hydraulic	6 ft	200 lb	NA	Jettisonable, no details	Verne Engineering	One manipulator is used to hold vehicle in place while the other works
		2	same	same	NA	2,600 lb vertical position	NA	Jettisonable, no details	same	
SHINKAI	1	6	Parallel Jaws	Electro-Hydraulic	3 ft 3 in.	33 lb	NA	Jettisonable, no details	Kawasaki Heavy Ind.	
SNOOPER	1	2	Circular Clamp	Electro-Hydraulic	NA	8 lb	NA	NA	Sea Graphics Inc.	
STAR II	1	4	Scissor	Electro-Hydraulic	4 ft 1 in.	150 lb	150 lb	Mechanical	Gen. Dyn.	
STAR III	1	6	Scissor	Electro-Hydraulic	4 ft	150 lb	400 lb	Mechanical	Gen. Dyn.	
TOURS	1	6	Parallel Jaws	Electro-Hydraulic	6 ft	NA	NA	None	Maschinen Gabler GmbH	
TRIESTE II	1	6	Parallel Jaw	Electro-Hydraulic	10 ft	500 lb	NA	Jettisonable, no details	ACF Electronics	
VOL-LI	1	5	Parallel Jaw	Electro-Hydraulic	5 ft 6 in.	150 lb	150 lb	Manual, hydraulic Pressure	HYCO	
YOMIURI	1	6	Clam Shell	Electro-Hydraulic	8 ft 1 in.	110 lb	NA	None	NA	

\*NA=Not Available

pressure-resistant suit, and the diver's arm provides the movement. Wilson (*ibid.*) provides a brief but informative treatment of manipulator power (actuation) in regards to the advantages and disadvantages of electro-mechanical versus electro-hydraulic actuators and Rockwell's table (Table 10.9) compares both approaches.

### Design and Capabilities

The design and capabilities of manipulators followed no particular course to an ultimate destination. Increased capabilities, such as more degrees of freedom or greater lifting and grasping power, were provided only if they were required to perform a particular task. The manipulators on the Navy's *SEA CLIFF* and *TURTLE* are indeed versatile, but for many submersibles they are unnecessary. For example, *DS-4000's* manipulator and claw may appear somewhat inadequate compared to the aforementioned, but for over 400 dives this arm provided all that was necessary for the scientific research of its users. So the question of such

things as how many degrees of freedom, type of claw and lifting capacity is really answered by balancing the trade-offs. If the dexterity of the human arm and hand is the goal, then expense, complexity, weight and extensive maintenance are some of the sacrifices—as well as a long wait, for this goal is a long way off. In the interim, Figures 10.39 and 10.40 present representative contemporary examples of manipulators; the characteristics of each can be found in Table 10.8. A brief discussion serves to introduce the capabilities of each and describe the field at large as well.

*SEA OTTER's* manipulator (Fig. 10.39a) is really what Wilson termed a special machine. It can only move up or down and relies on the submersible to train it left or right or move it forward. The hydraulic cylinder between it and the skid pushes it up or down by virtue of a hand pump in the pressure hull. The device was fabricated for attaching a lift hook to a sunken tug boat. The lift hook was held in the terminal end by a dowel. When it was in place, the dowel was removed by

**TABLE 10.9 COMPARISON OF ELECTRIC AND HYDRAULIC MOTION ACTUATION SYSTEMS  
[FROM REF. (32)]**

Electric	Hydraulic
<ul style="list-style-type: none"> <li>● Electromechanical systems are expensive</li> <li>● DC motors start and stop smoothly</li> <li>● High-torque low speed DC motors are heavy and bulky</li> <li>● Small AC and DC motors require high speed operation, which requires clutches, gear reduction, and brakes to provide adequate motion characteristics</li> <li>● Foreign to the seawater environment so must be oil-filled. Seawater intrusion usually results in system failure.</li> <li>● Brush insulation must be prevented by increasing contact force, thereby reducing operating life and reliability</li> <li>● Internal wiring easily accomplished eliminating snagging problems</li> <li>● High and low speed continuous rotation easily obtained</li> </ul>	<ul style="list-style-type: none"> <li>● Hydraulic systems are less expensive than electromechanical systems</li> <li>● Compatible with the environment</li> <li>● High power to unit weight ratio allows use of small components</li> <li>● Internal leakage of fluid allows drift, overshoot and loss of efficiency</li> <li>● External leakage degrades efficiency but may not abort the operation</li> <li>● Motions automatically braked by closing of control valve</li> <li>● Simple overload protection provided by relief valves</li> <li>● External hosing causes snagging problems, internal fluid routing is complex</li> <li>● Pressure compensation, required for a lightweight system, prevents arm use while changing depth</li> <li>● Continuous rotation actuators unreliable</li> </ul>

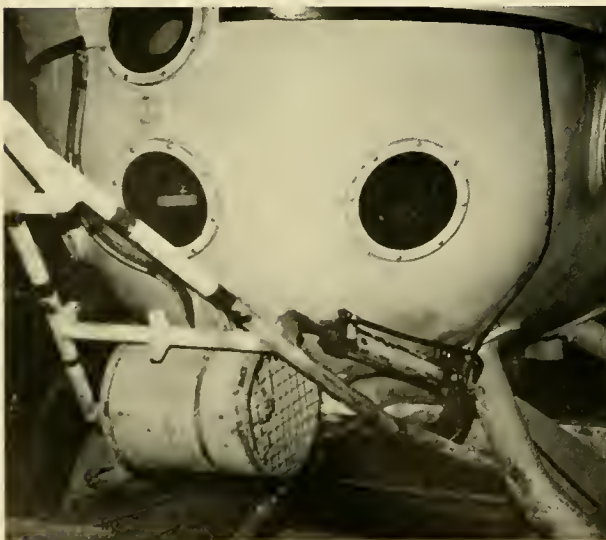

a)



b)

Fig. 10.39 Manipulators of a) *SEA OTTER*, b) *SHELF DIVER*, c) *DS-4000*, d) *STAR II*, e) *NEREID 330* and f) *PISCES III*.  
(b, Perry Sub. Bldrs., c, NAVOCEANO, d, Gen. Dyn. Corp., e, Nereid nv, f, HYCO)



c)

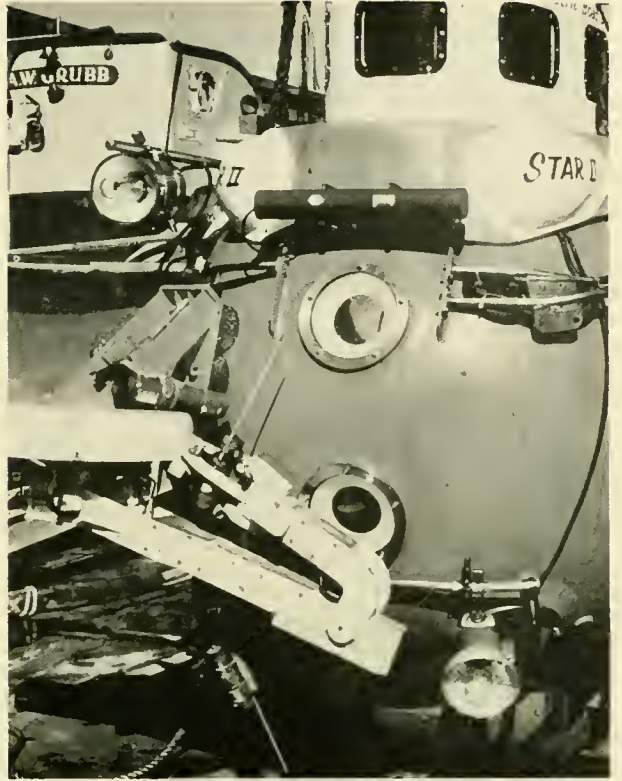

d)



e)

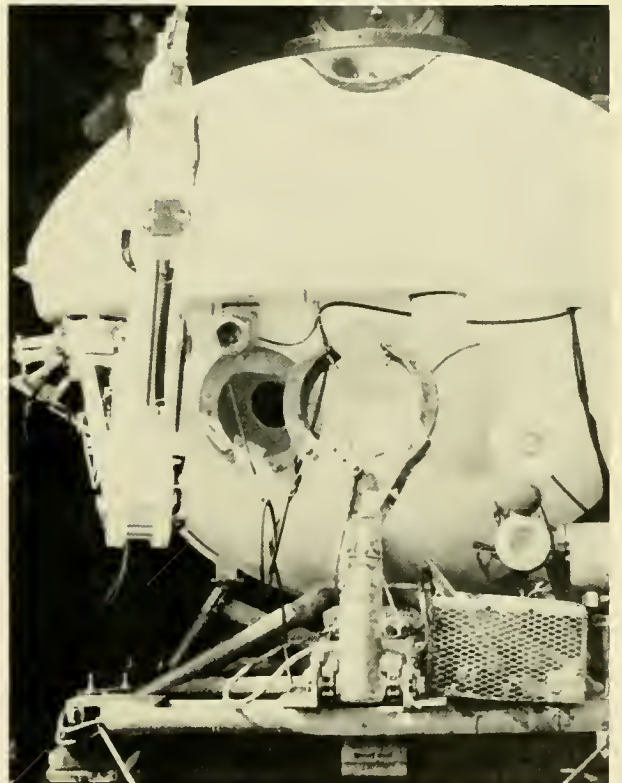

f)

taking in a string which ran from it to a manually-cranked reel on the pressure hull. "Jury rigged" though it may have been, the hook was placed, and the tug boat was salvaged. **SEA OTTER**, it should be mentioned, does have a more sophisticated capability in the form of a manipulator of the **BEAVER** type which could have been employed if needed.

**SHELF DIVER's** manipulator (Fig. 10.39b) is typical of Perry Submarine Builder's approach. A hydraulic pump in the pressure hull provides power for three degrees of freedom within its 6.5-foot-diameter working area. The manipulator is not jettisonable, but it has a feature whereby the hydraulic lines can be opened and the ambient pressure (caused by the entry of seawater into the lines) will open the claw and retract the arm. The Perry manipulator was designed for sample retrieval, as was **DS-4000's** (Fig. 10.39c). In the latter case, the arm has three degrees of freedom and also operates on hydraulics; it can be jettisoned if necessary.

**STAR II** (Fig. 10.39d) obtains an additional degree of freedom by including an elbow in its arm. Also, its shoulder joint can rotate more liberally in the horizontal than that of the two predecessors above.

**NEREID 330's** manipulator (Fig. 10.39e) is by far the most powerful of any submersible, and its owners refer to it as a "two stage manipulator system." The heavy work arm is a hydraulic crane that lifts 2,500 pounds at a reach of 15 feet and also serves as the base for a smaller lightweight 'intelligent' arm behind the strong claw. With the strong claw attached to the work object the dexterity of the small arm becomes as good at 2 feet as at 15 feet. The small arm is partly equipped with manually driven joints to give the operator a sense of "feel." To provide a stable base for the manipulator, the vehicle is capable of obtaining 5,500 pounds of negative buoyancy by taking on seawater.

**PISCES III** (Fig. 10.39f) carries both a grasping and a "working" manipulator; the latter is termed the PHA. The circular grasping manipulator serves primarily to hold the vehicle in place while the more dexterous PHA works. Both manipulators are jettison-

able, and the PHA may be operated at various speeds. All **PISCES** class submersibles are capable of this arrangement, and the aluminum PHA (which can operate to 6,500 ft) is standard equipment on all HYCO-built vehicles. An upgraded HYCO version of the manipulator shown in Figure 10.39f is the manipulator shown in Figure 10.40a. This has six degrees of freedom and a pressure-compensation system to permit operation to any depth. The later HYCO submersibles (**AQUARIUS, ARIES**) have this manipulator in place of the PHA.

The manipulator on **DEEP VIEW** (Fig. 10.40b) was an experimental model. It is shown here, not because it represents a radical departure or improvement in capabilities or design, but because it is a different approach to collecting samples with the same degrees of freedom as the Perry and **DS-4000** manipulators.

**ALUMINAUT's** manipulators (Fig. 10.40c) represented the most advanced technological achievement of the late sixties. Each arm has six degrees of freedom. Working together they provide a high degree of versatility. When not in use, the manipulators retract and fold back under the bow.

**SEA CLIFF's** and **TURTLE's** manipulator system (Fig. 10.40d) includes an external stowage arrangement, provision for mounting a television camera and underwater light, a jettison system, interchangeable tooling capacity, sample collecting basket and a remote control system. The manipulators are capable of nine separate motions, including a tool power takeoff and tool release, and they may be jettisoned separately, or both at once. Three tool stowage racks and one sample basket mounted forward of the manipulators' shoulder assemblies provide for tool interchangeability and sample collection (these racks and baskets are jettisoned with the manipulators). An additional sample basket can be substituted for one tool rack if desired.

Each manipulator arm consists of four basic assemblies: shoulder, upper arm, lower arm, and wrist. These assemblies are cylindrical to minimize the possibility of entanglement. They are filled with manipulator hydraulic return oil; thus each assembly is pressure-compensated to slightly above sea





a)



b)

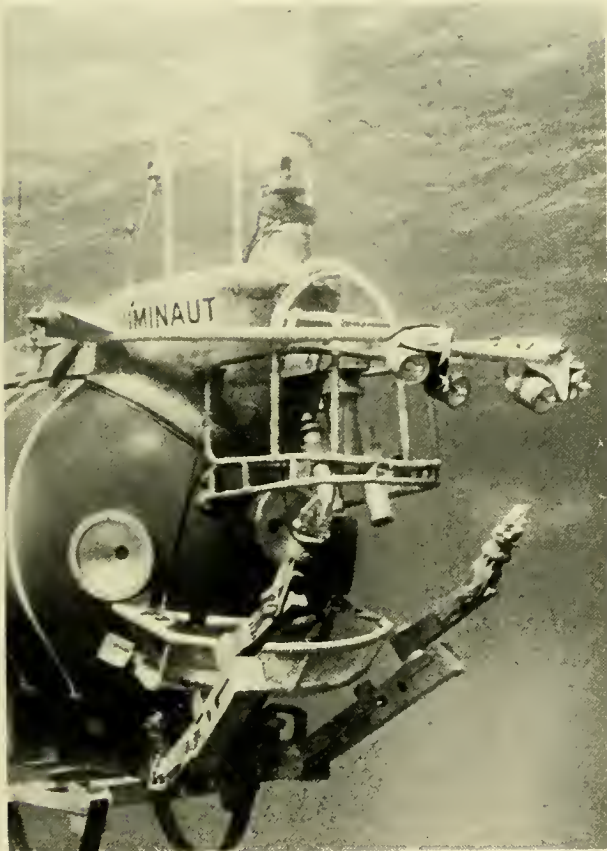

c)



d)

Fig. 10.40 Manipulators of a) AQUARIUS, b) DEEP VIEW, c) ALUMINAUT, d) SEA CLIFF & TURTLE, e) BEAVER and f) NEKTON. (b. U.S. Navy, c. Reynolds Submarine Services)

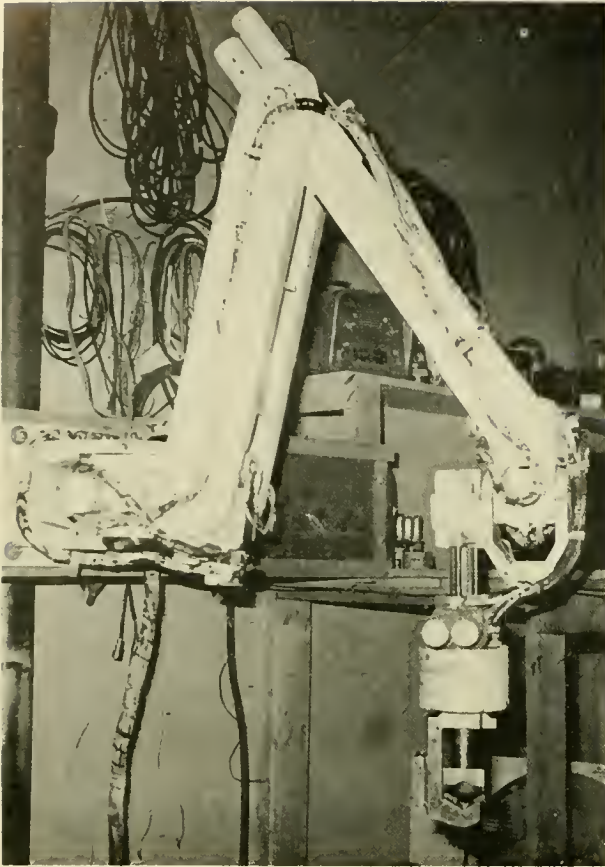

e)

pressure by the hydraulic system compensator. Changes in oil volume due to temperature variations are also controlled by the hydraulic system compensator. Additional over-pressure protection of components is provided by individual assembly relief valves. Each of the four assemblies contains a seawater leak detector.

Any of four interchangeable terminal devices, or tools, may be attached to the wrist. The tools permit grasping and drilling, as well as cutting (e.g., cables). When not in use, the tools are stored in a tool rack near the manipulator shoulder. Pressure and temperature compensation of the tools is provided by integral compensators.

Two manipulator replacement counterweights are provided for port and starboard installation when the vehicle is operated with either or both manipulators removed. Each counterweight compensates for the weight of a manipulator to maintain vehicle buoyancy and trim.

The **BEAVER**-type manipulator in Figure 10.40e was the first to include variable speed



f)

or rate control. It was designed and constructed at North American Rockwell for use aboard **BEAVER**, which presently has two such manipulators. With eight degrees of freedom and variable rate control, the manipulators are capable of performing a wide variety of tasks—particularly so since the terminations (claws) are interchangeable *in situ* with an underwater tool array consisting of an impact wrench, cable cutter, stud gun, centrifugal jet pump, grapple and universal chuck. These tools are mounted on a lazy-susan type of device beneath the bow and in full view of the operator.

**NEKTON's** manipulator (Fig. 10.40f) is a pragmatic detour around systems analysis. It consists of no more than a thru-hull steel rod which can be pushed, pulled, twisted and rotated through and about the penetration, within a 90-degree included angle and a claw which can be opened or closed by the operator who also provides the muscle power. The arm is a 0.5-inch-diameter stainless steel tube which encloses a  $\frac{3}{8}$ -inch-diameter solid rod. Inboard handles, when squeezed, pull

the solid rod into its housing and an arrangement between claw and housing causes the claw to close. A ball socket at the hull penetration allows rotation through 45 degrees on either side of the rod. At 1,000 feet deep the external pressure causes the arm to retract into the hull, but a nylon line and pulley arrangement allows the operator to extend the arm. In terms of freedom, it has at least eight, including force feedback and variable speed control. To collect samples a cloth bag is reeled down on a string to an appropriate position and, with the sample inside, is reeled back up on the hull. In terms of thru-hull waterproof integrity, both *NEKTON BETA* and *GAMMA* have been classed by ABS; hence, one might properly assume that this body of expertise found nothing amiss. There is little else that can be said of this approach except that at some point it is depth-limited and that whoever conceived it should have received an immediate raise in salary!

### Claws

Several types of claws or hands can be seen in Figures 10.39 and 10.40. *TURTLE* has a parallel type of jaw on the starboard manipulator and a Dorrance type of claw on the other. *BEAVER*'s claw is termed a hook type, *PISCES III*'s grasping claw is a circular clamp, *DS-4000*'s is an orange peel type, *DEEP VIEW*'s is a clam shell, and *NEKTON*'s is a scissor type. The type of claw depends, obviously, on the nature of the work. Orange peel and clam shell varieties are best for collection of soft sediment samples, the scissors and Dorrance types of claws are good for holding irregularly-shaped objects, and hook types hold cylindrical objects well.

### Control

Devices which the operator employs to maneuver or control manipulators are either portable or fixed, and each manipulator motion has its own button or switch on the control device. Portable control boxes are mandatory when the operator is moving from one viewport to another and physically cannot reach a fixed control. This is the situation in *ALVIN* and an early version of its manipulator control box is shown in Figure 10.41. Where panoramic visibility is available, fixed controls are acceptable. Fig-

ure 10.42 shows the fixed manipulator control panel on *PC-14*; each knob controls a specific motion by dispatching hydraulic fluid to the appropriate hydraulic line.

Owing to the wide variety of tasks one can envision for manipulators, it would be fruitless to make a blanket recommendation applicable to all vehicles. Experience, nonetheless, has provided some excellent general guidelines to the manipulator designer which are germane to all. In a 1966 article on manipulators, Hunley and Houck (35) presented some lessons learned on *TRIESTE I* and *II*. These lessons warrant due consideration because the tuition was paid in the form of lost manipulators and lost capability. The following is extracted from their experiences:

- Emergency jettisoning devices should not allow inadvertent release of the manipulator.
- Some means to view the manipulator when stored (to insure that it is, in fact, stored) should be provided.
- Extended immersion in seawater calls for corrosion-resistant materials.
- Television cameras and lights on the claw or forearm are invaluable aids for fine positioning or inspection.
- External wire or cabling can be torn loose during tows.
- Internal leakage in joint actuators may cause the manipulator to creep from its last position.

A more recent report by Pesch *et al.* (36) discussed the test results of divers versus manipulators in undersea work. While the results are fairly predictable (the diver always won), several of the general conclusions can be applied to increasing manipulator performance, and others may serve to alert the designer to conditions of which he might not be aware. The following is extracted from reference (36):

- Quite frequently the manipulator blocks the work object from the operator's view.
- Requirements to align a tool perpendicular to a surface should be reduced because of optical distortion, empty field conditions and the simple mechanical difficulty of alignment.
- The manipulator color should afford moderate background contrast. A white

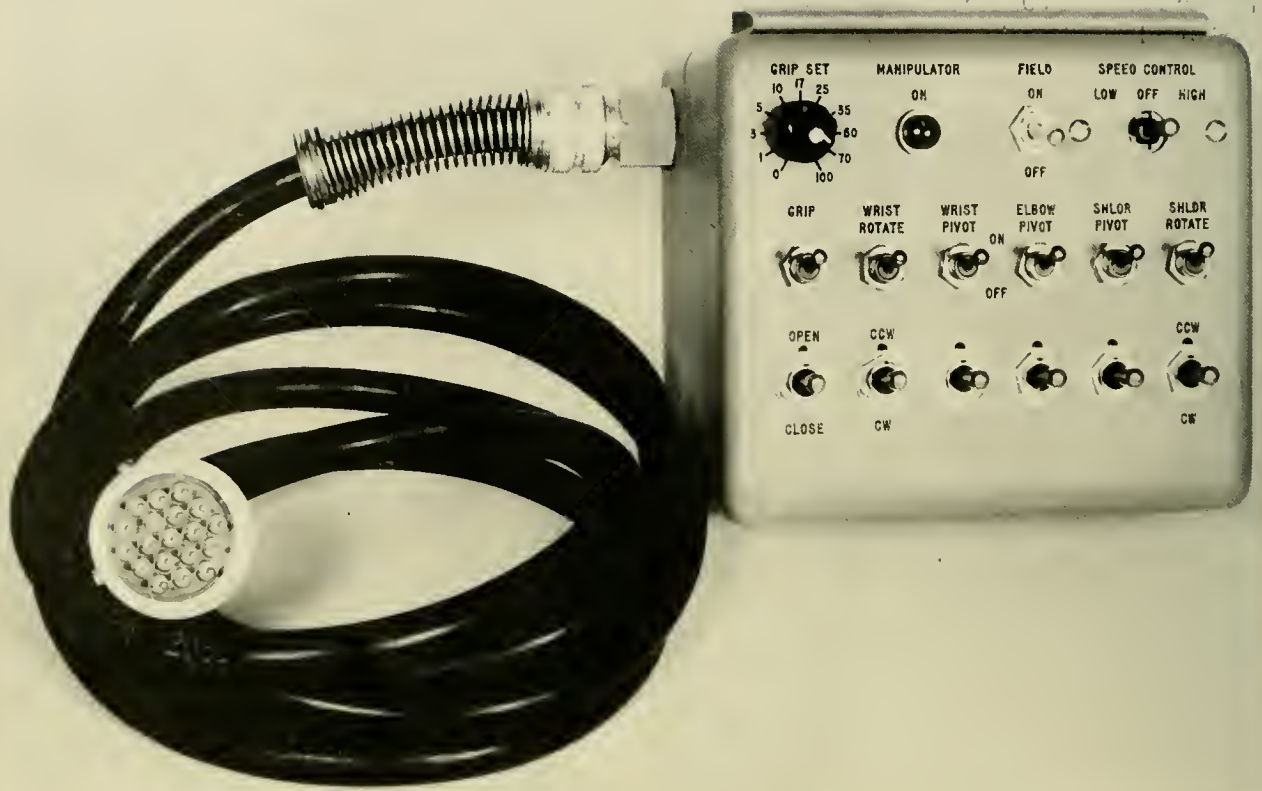

Fig. 10.41 An early model of ALVIN's portable manipulator controls. (WHOI)

arm provides too much backscatter and a dark arm cannot be seen.

- Both manipulator operator and vehicle operator should have the same view if submersible movements and manipulator operations are to interact.
- Common machine shop practices, *e.g.*, self-alignment, self-tool feed, torque-limiting clutches and step drills for pilot holes, could be applied profitably to manipulator tool design.

There are indeed many improvements which submersible manipulators must provide if they are to realize anywhere near the capability of the diver. But the onus is not on submersible operators alone. The designer of underwater hardware to be worked on is one of the major obstacles standing in the way of submersible performance. Look closely at Figure 10.43, where the diver is making a

midwater electrical connection in seconds that would take a submersible minutes and perhaps hours to complete. In addition to the connector, there are bolts and nuts that also might need disconnecting, a relatively easy task for the diver. Why are they easy tasks? Quite simply because they were designed to be performed by the human arm and hand with assistance from human hand-held tools. Herein lies the crux of the problem: If the ends of the nuts or the connector had been designed for grasping by a hook, parallel jaws or Dorrance-type claw, the task of the submersible would be eased immensely. No doubt, equaling the human "manipulator" is a difficult, if not impossible, task, but the human can only go so deep in the ocean. Hardware knows no depth limit, and if the hardware designers anticipate replacement of parts or installation of devices subsequent

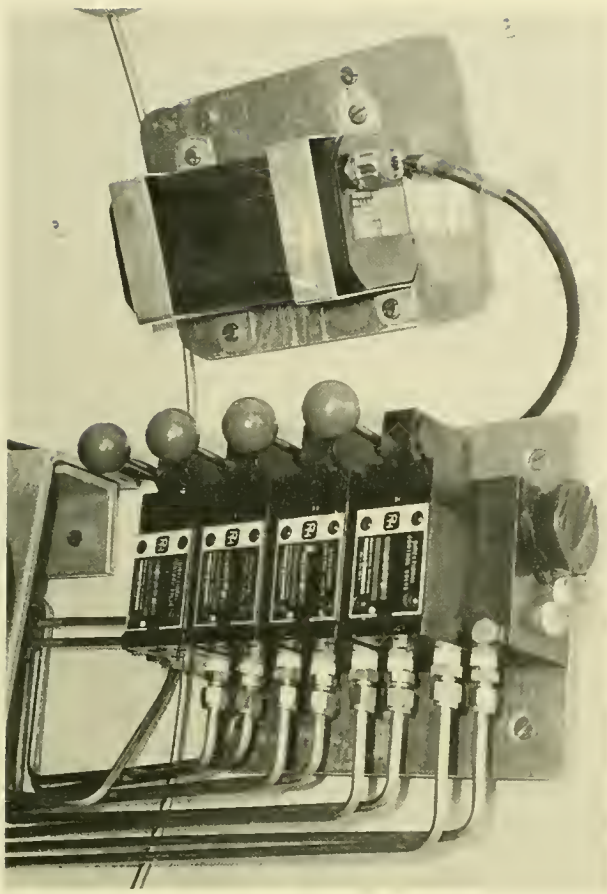

Fig 10.42 Manipulator control panel on PC-14. Each knob controls a separate manipulator function.

3. Tyler, J. E. & Preisendorfer, R. W. 1962 *Light in the Sea*. v. 1, p. 348-397, John Wiley & Sons, N.Y.
4. Larson, D. A. & Rixton, F. H. 1969 *Underwater lighting and new light sources*. Undersea Tech., Sept., p. 38-39; 56-57.
5. Strickland, C. L. & Hittleman, R. L. 1968 *Underwater light sources*. Oceanology International, Sept./Oct., p. 36-39.
6. Waltz, A. R. 1970 *A Study of Light Sources for Underwater Use*. NURDC Rept. NUCTM 444, 53 pp.
7. Green, P. S., Bellin, J. L. S. & Knollman, G. C. 1968 *Acoustic imaging for viewing in turbid water*. Undersea Tech., May, p. 48-51.
8. Vigil, A. E. (no date) *A New Low Light Level Television Camera for Underwater Application*. Hydro Products, San Diego, Calif. (Unpub. manuscript).
9. Marine Tech. Soc., 1968 *Selected Papers from Pressure Depth Symposium*. Jour. of Ocean Tech., v. 2, n. 2, p. 27-29.

to immersion beyond diver depth, then they must bear in mind that non-human, not human, manipulators will be doing the work. Several orders of magnitude increase in present manipulator performance could be realized if designers would keep this fact constantly in mind.

## REFERENCES

1. Volberg, H. W. 1964 *CTFM sonar for deep submergence*. Undersea Tech., Jan., p. 38-41.
2. *Undersea Technology Handbook Directory*. 1973 Compass Publications, Arlington, Va.



Fig. 10.43 A diver makes an electrical connection on SEA LAB III. (U.S. Navy)

10. Bass, G. F. & Rosenkrantz, D. M. 1968 *A Diversified Program for the Study of Shallow Water Searching and Mapping Techniques*. Final Rept. for the Office of Naval Research under contract N00014-67A-0216-0002, 130 pp., Univ. Museum, Univ. of Penna.
11. Karr, B. N. & Gillen, R. G. 1969 *Marine radio communications*. in *Handbook of Ocean and Underwater Engineering*. McGraw-Hill Book Co., p. 11-92 to 11-97.
12. National Defense Research Comm. 1969 *Physics of Sound in the Sea*. Department of the Navy, Headquarter Naval Material Command, 566 pp., U.S. Government Printing Office, Wash., D.C., 20402.
13. Ocean Industry 1967 *Three diver communication systems end "Donald Duck" distortion*. v. 2, n. 10, p. 28-29.
14. Lauderdale, C. L. 1973 *U.S. Marine Corps Testing of Swimmer Acoustic Communications*. Naval Coastal Systems Laboratory, Panama City, Fla., 27 pp., 3 appendices.
15. Bowditch, N. 1966 *American Practical Navigator*. U.S. Naval Oceanographic Office, H.O. Pub. No. 9, 1524 pp.
16. *Proceedings of First Marine Geodesy Symposium*. Columbus, Ohio, 28-30 Sept. 1966, U.S. Government Printing Office, Wash., D.C., 301 pp.
17. *Marine Geodesy. A Practical View*. A second symposium on Marine Geodesy, 3-5 Nov. 1969, Mar. Tech. Soc., Wash., D.C., 333 pp.
18. Raudsep, I. D. 1969 *Ship positioning determining systems*. Oceanology Intl., Mar./Apr., p. 45-49.
19. Rainnie, W. O. 1971 *Equipment and instrumentation for the navigation of submersibles*. Underwater Jour., June, p. 120-128.
20. Barringer, J. L. 1967 *CUBMARINE operations in Spain*. Geo-Marine Tech., v. 3, n. 1, p. 12-18.
21. Pollio, J. 1968 *Undersea Studies with the Deep Research Vehicle STAR III*. Naval Oceanographic Office, I.R. 68-103, 73 pp. (Unpub. manuscript).
22. Fagot, M. & Merrifield, R. 1969 *Tracking BEN FRANKLIN During the Gulf Stream Drift Mission*. Proc. of the ION National Marine Navigation Meeting, 2nd Sym. on Manned Deep Submergence Vehicles, 3-4 Nov. 1969, San Diego, Calif., p. 261-275.
23. Busby, R. F. & Merrifield, R. 1966 *Undersea Studies with the DSRV, ALVIN, Tongue of the Ocean, Bahamas. Sept. 1966*. Naval Oceanographic Office, I.R. 67-51, 54 pp. (Unpub. manuscript).
24. Mackenzie, K. V. 1970 *Early history of deep submergence navigation aboard TRIESTE*. Jour. Inst. Navigation, v. 17, n. 1, 12 pp.
25. Busby, R. F. & Hart, W. E. 1966 *Seafloor navigation for deep submergence vehicles*. Jour. Inst. Nav., v. 13, n. 2, p. 141-145.
26. Navigation Equipment Trials: *DSRV Doppler Sonar Test Results*. 1968 DSSP Office, Pub. No. GB-2510-1001.
27. Kritz, J. 1970 *Doppler sonar navigator for work submersibles*. 2nd Ann. Off-shore Tech. Conf. Pap. No. OTC 1266, p. 403-414.
28. Woods Hole *Oceanographic Institution 1969 Deep Submergence Research Conducted During the Period 1 Jan. - 31 Dec. 1968*, WHOI Tech. Rept. 69-17.
29. Dunn, A.T. 1969 *The actual navigation of SCORPION operations. Phase II*. Proc. of the ION National Marine Navigation Meeting, 2nd Sym. on Manned Deep Submergence Vehicles, 3-4 Nov., 1969, San Diego, Calif., p. 242-252.
30. Winget, C. L. 1969 *Hand Tools and Mechanical Accessories for a Deep Submersible*. WHOI Pub. Ref. 69-32, 180 pp.
31. Worthington, R. K. R. 1969 *Navigation of deep submersibles in close search*. Proc. of the ION National Marine Navigation Meeting, 2nd Sym. on Manned Deep Submergence Vehicles, 3-4 Nov., 1969, San Diego, Calif., p. 253-259.
32. Ballinger, H. A. 1967 *Telechiric devices and systems*. Tech. and the Sea Bed Proceedings of a Conf. at the Atomic Energy Research Establish., Harwell, Eng., 5-7 April 1967, v. 1, p. 238-272.
33. Rockwell, P. K. 1971 *Underwater Manipulative Construction Systems (UMCS)*. NCEL Tech. Note N-1158, 86 pp.
34. Wilson, K. B. 1969 *Manipulators*. in

**Handbook of Ocean and Underwater Engineering.** McGraw-Hill Book Co., p. 4-11 thru 4-23.

35. Hunley, W. H. & Houck, W. G. 1966 **Underwater manipulators.** Naval Engineers Jour., v. 78, n. 6, p. 1003-1009.

36. Pesch, A. J., Hill, R. G. & Klepser, W. F. 1971 **Performance comparisons of scuba divers vs. submersible manipulator controllers in undersea work.** 3rd Ann. Offshore Tech. Conf., 19-21 April 1971, Houston, Tex., Paper No. OTC1437, p. 221-232.







# 11

## SCIENTIFIC AND WORK EQUIPMENT

The most readily available data-gathering system aboard a submersible is the human being, and for this reason the diving tasks up to the early 1960's relied mainly on the scientific and technical observer. It was soon obvious that photography was the best answer to "What did you see?" and cameras became standard equipment. With face pressed against the plastic viewports and a camera held either inside or outside the pressure hull, the diving scientist recorded and described details of the undersea world that over-the-side instruments encountered mostly by chance. According to Ballard and Emery (1), almost 200 scientific articles were published by submersible scientists of the mid-1960's; these were based, for the most part, on visual observations.

As scientists and engineers grew accustomed to submersible operating capabilities, new and modified instruments appeared. This was inevitable. Visual observations, no matter how detailed or photographically documented, required supporting data to help interpret the observed phenomena.

The biologist, for example, not only wanted to collect organisms but also wished to know the physical and chemical characteristics of the water in which they resided. The geologist, on the other hand, not only required samples of the bottom, but also wished to know, among other things, its slope, its cohesiveness and the strength of near-bottom currents. The diving engineer or salvor, while increasing his understanding of an instrument's or object's performance, wanted

to do something about it, and he became interested in tools for cutting, grasping or repairing. The result was a wide variety of specialized instruments for particular submersibles; some worked well, others not at all.

Only in very few instances was the owner or operator of a submersible its primary user. In the commercial field the vehicle was equipped to perform the basic functions of safe diving and viewing, and the owner anticipated that, for the most part, the user (lessee) would supply his own equipment for special tasks. Where the owner was the user, *e.g.*, International Hydrodynamics, the submersible was equipped with instrumentation the owner/user felt was necessary to perform the advertised services. In general, this latter requirement, in addition to equipment required by the pilot to assure safe operations, included lights for viewing and photography, cameras, depth gages, echo sounders and manipulators. Essentially, the scientist or engineer hailed an underwater taxi. If much more than safe transportation was desired, he had to supply the additional capabilities himself.

In the early 1960's, the submersible diver had very few instruments from which to choose: Underwater lights, cameras and depth gages were available from over-the-side systems. Echo sounders were numerous, but the transducers were those conventionally mounted on surface ship hulls only a few feet below the surface, and the great pressures exerted on these externally-mounted devices could affect their beam pattern and, hence, the accuracy of the data. Water temperatures could be measured by adapting over-the-side instruments, as could sound velocity and current velocity. The last could be used only when the vehicle was bottomed. Some bottom sampling capability existed, but only in the form of 1- to 2-foot-long cores of soft sediments or small, loose fragments that could be scraped or picked from the bottom. In some instances it was possible to obtain measurements from instruments within the pressure hull. Cosmic ray penetration was measured in this manner from *TRIESTE* prior to its record dive. But, for the most part, the user of submersibles was forced to either improvise his own instru-

ment or modify existing ones to particular tasks and submersibles.

Manufacturers of oceanographic equipment were interested in this potentially burgeoning market, but several factors caused them to proceed with caution. Predominant among these was the lack of a clearly defined need to produce an instrument or instruments which would find a wide market (2). One-of-a-kind instruments are expensive to design and produce and are not always profitable when they must be made to perform under the high pressure, low temperature deep ocean environment. In the event an instrument was successful, what would be the size of the market? In the incipient submersible industry there were no clearly defined missions where a specific instrument could be expected to find application on every dive and every vehicle. Private industry was understandably hesitant to invest its own funds and time developing instruments for which there might be no market. Indeed, considering the wide variety in submersible characteristics, an instrument designed to work on one might not be adaptable to any other. Consequently, the scientist and engineer was left mainly to his own devices in developing instruments and work tools.

## CONSTRAINTS ON SUBMERSIBLE INSTRUMENTS

The utility of an instrument or work tool from a submersible is governed by 1) dimensional and performance constraints (including weight & balance) of the submersible itself, 2) the overall submersible system and its method of operation and 3) safety considerations to passengers, support personnel and the vehicle.

Most scientific instruments consist of a sensor and a recorder—the former located outside the pressure hull and the latter inside. Both the seawater environment and the submersible's internal environment apply a peculiar set of operating conditions. Assuming the vehicle's payload can accommodate the instrument, the following are the major constraints one must deal with to employ an instrument safely and successfully.

## Hatch Diameter

Ranging from 15.75 to 30 inches in diameter in different submersibles, the user must be certain that his instrument will physically fit inside the pressure hull. In some instances the outside diameter of the hatch can be several inches greater than the inside diameter, the latter, of course, being the controlling dimension. *ALUMINAUT* presents a unique problem in that its pressure hull hatch is 19 inches in diameter, but its sail hatch is only 17.75 inches. Submersibles with plastic bow viewing domes offer more flexibility because the dome can be removed for installation of devices larger than the hatch.

## Internal Location

Instruments must be positioned to avoid interference with operational controls, crew safety and comfort, access to junction boxes and fuses, viewing and access to emergency breathing or escape devices. If more than one instrument is to be visually monitored, they should be grouped closely together to conserve movement. In the cramped confines of the smaller submersibles it may be difficult to meet these requirements if several instruments are desired.

## Electrical Interference

Submersible electrical power cables are, for the most part, unshielded (3). Therefore, to prevent the vehicle's electronics from interfering with scientific instruments the latter's cables should be shielded and physical separation of thru-hull penetrators for both should be sought. Shortest possible cable runs assist in further minimizing interference.

## Electrical Power

Submersible-supplied electrical power is characterized by surges and spikes; therefore, voltage regulators for each instrument are desirable. It is not uncommon for DC voltages to drop about 20 percent during a long duration dive (4).

## Internal Atmosphere

The atmosphere in a submersible is characterized by extremes which may be detrimental to electronics. In the tropics and sub-

tropics, high temperatures and high humidity prevail on the surface and at shallow depths; condensation with drippage characteristically occurs with greater, colder depths. Electrical power is usually too limited for an air conditioning system or the like. Light levels within the pressure hull are low and digital read-outs or dials should be lighted or luminous.

## Connectors/Penetrators

There is no standard electrical connector or penetrator; therefore, a complete change of instrument terminations may be required. The reliability of underwater connectors still leaves a great deal to be desired.

## Entanglement

Where instruments are external to the submersible's fairings, they must be designed to minimize entanglement with cables or ropes or other protruberances. In the event that such entanglement is a possibility, provisions should be made to jettison the instrument.

## Wave Slap

Under-tow instruments can be torn loose or severely damaged by wave slap and should be either designed to withstand 1,000 psi or located to neutralize its effects—preferably both.

## Unhindered Data

Placing an instrument within the vehicle's fairings might preclude the free flow of water necessary to obtain realistic data; this should be considered when locating the instrument, as well as the possible influence of the submersible itself upon the data.

## Attachment

Every submersible differs in the method by which instruments may be attached; there are no standard mounting racks. When an instrument is attached below the vehicle's waterline, the mounting configuration should be designed for quick attachment or release by divers. Towed vehicles—such as *ALUMINAUT* and other large submersibles—fall into this latter category.

## Trim and Ballasting

The metacentric height is usually so low on submersibles that even a small instrument mounted in the wrong location may cause a significant change in trim characteristics. In the same vein, a protruding instrument may change the hydrodynamics or "flight" characteristics of a vehicle and, consequently, its control underway. Thus, weight and balance calculations must precede attachment. A payload of several hundred pounds does not necessarily mean that the entire payload capability can be used at one location on the vehicle, but instead, it may have to be distributed equally throughout.

## Corrosion and Fouling

The great majority of submersibles are brought aboard ship following each dive and washed down with fresh water. Consequently seawater corrosion and fouling by marine organisms is usually not a problem. The large, towed vehicles, however, are subject to both problems. Corrosion of instruments has not been severe because very few of the large submersibles have operated under a contract for sufficient continuous periods of time to encounter a serious corrosion problem. Fouling, on the other hand, was a problem during *BEN FRANKLIN*'s pre-Gulf-stream drift testing period. *BEN FRANKLIN*'s mooring was in an area of considerable water circulation where goose-neck (Balanoid) barnacles attached to the vehicle and its equipment. In a 3-week period, the barnacles (2–3 mm across) colonized the protective glass covering over the camera lenses, the strobe light bulbs and transducer heads to a density of 80–100 individuals per square inch (Fig. 11.1). This was cause for concern as the vehicle was scheduled for a 30-day submergence and such a colonization/growth rate could be detrimental to the mission. Investigation into available anti-fouling methods revealed no positive deterrent; consequently, no protective measures were taken. At the end of the 30-day submergence, careful inspection revealed no fouling organisms present; it was deduced that *BEN FRANKLIN*, drifting at a rate equal to the current, was unsuitable as a home for organisms dependent upon water moving past them to supply food and remove waste products.

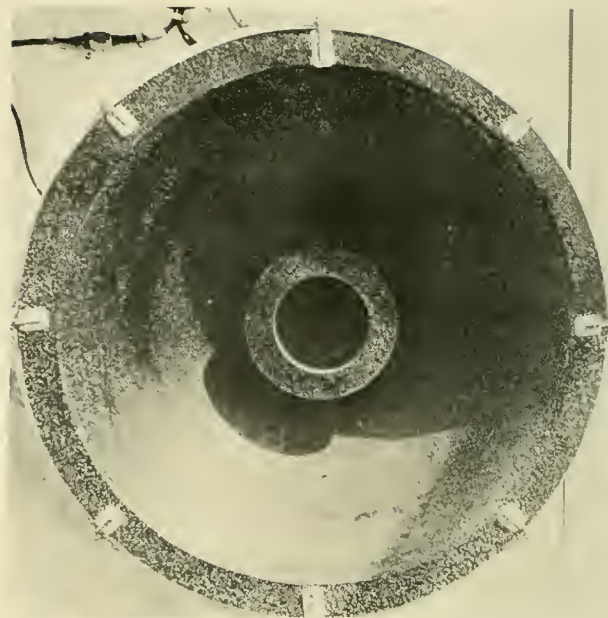

Fig. 11.1 Barnacle-encrusted transducer after 3 weeks in Port of West Palm Beach, Fla. (NAVOCEANO)

## Pressure (Depth)

While it may appear obvious to be certain that an instrument can sustain the maximum pressures anticipated on a dive without leaking or imploding, there is a safety factor which should be included in their design. For example, in 1965 the *PC-3B* was conducting a 600-foot cable survey dive in the Bahamas, and it had an externally-mounted acoustic pinger for surface tracking. The pinger was advertised for a 600-foot depth capability, which was absolutely true, for at 610 feet there was a cannon-like bang produced by the imploding pinger. A safety factor in instruments at least equal to that of the submersible should be included, not only to assure use of the instrument but also to avoid the possibility of creating an implosion shockwave that might be sufficient to crack a viewport.

## Negative Buoyancy

Several ocean bottom instruments (corers, sound velocity probes, bearing strength probes, etc.) and engineering tools

(wrenches, drills, etc.) depend upon the submersible's manipulator to apply force either into the bottom or against other surfaces; to do so, the vehicle must be capable of obtaining sufficient negative buoyancy to remain stable while the instrument or tool moves. In many cases the submersible cannot obtain sufficient buoyancy and, for example, instead of the corer penetrating the bottom, the submersible rises off the bottom by virtue of its light weight. The problem is similar to those of outer space and near-weightlessness and is a serious consideration. In 1967 *ALUMINAUT* was frustrated in this way while attempting to collect 3-foot-long sediment cores off St. Croix. When *ALUMINAUT*'s manipulator inserted the hollow coring tube to approximately 10 inches in the sediment, further application of vertical force caused the 76-ton (dry weight) submersible to rise off the bottom.

## Launch/Recovery

Several instruments have been used from submersibles which are lightweight and bulky (Fig. 11.2). While successful employment may be realized under ideal conditions, the user must consider the impact of foul weather which might move in during the dive and create a surface situation which endangers the instrument during retrieval. *DEEP QUEST* experienced this situation and, by colliding with the forward bulkhead of *TRANSQUEST*'s stern well, lost a camera to the sea. *ALVIN* experienced a similar retrieval problem and lost, but later salvaged, its mechanical arm (5).

The above considerations concerning scientific and engineering instruments on submersibles took many years and many dives to evolve. While many of the problems were anticipated, their frequent occurrence was not. For example, Table 11.1 lists problems



Fig. 11.2 Acoustic receiving array on *STAR III*. (USNUSL)

TABLE 11.1 SUMMARY OF INSTRUMENTATION PROBLEMS DURING NAVOCEANO OPERATIONS

Submersible and Date	Problem	Cause
<b>CUBMARINE PC-3B</b>		
6/2/66	1. no reply from transponder 2. no recorder in system	1. batteries did not take charge 2. no internal space available
6/7/66	1. low transponder signal amplitude	1. batteries not fully charged
6/8/66	1. no transponder reply after 3 hr 2. pulse amplitude not above noise level 3. transponder replies erratic ( $\pm 10$ ms)	1. (same as above) 2. noise radiated by vehicle sources 3. unknown
6/9/66	1. synchronous pinger erratic 2. transponder failed	1. radiated noise interference 2. internal failure — bad transistor
6/10/66	1. external camera erratic	1. marginal power supply
6/15/66	1. one transponder signal lost in noise	1. interference from CO <sub>2</sub> scrubbers
<b>ALVIN</b>		
9/6/66	1. external camera inoperative	1. camera flooded
6/15/67	1. transponder navigation system marginal	1. high temp. & humidity, interference from Fathometer, radiated interference
6/20/67	1. precision depth gage erratic	1. radiated noise and voltage surges when ballast pumps activated
6/22/67	1. external camera not operating continuous	1. intermittent internal ground
<b>DEEPSTAR 4000</b>		
11/3/67	1. sound velocimeter erratic 2. current meter failed 3. external camera failed 4. internal cine-camera failed 5. transponder inoperative	1. radiated noise and voltage surges 2. flooded connector 3. broken lead in connector 4. ground in motor drive 5. internal failure
11/11/67	1. thermistor inoperative 2. volume reverberation experiment cancelled	1. internal failure 2. cracked mounting frame could not support weight of hydrophone
11/22/67	1. movie lights could not be turned off	1. high pressure malfunction
<b>STAR III</b>		
3/8/67	1. TV marginal	1. interference from pinger
3/9/67	1. no photography	1. strobes broken during launch
3/11/67	1. one external camera inoperative	1. stbd. camera flooded
3/29/67	1. transponder system erratic	1. acoustic interference from tracking pinger
4/5/67	1. strobe light inoperative	1. broken lead in connector
<b>ALUMINAUT</b>		
10/12/66	1. current direction indicator failed 2. temp-depth erratic	1. internal failure 2. subbottom profiler interferes

**TABLE 11.1 SUMMARY OF INSTRUMENTATION PROBLEMS DURING  
NAVOCEANO OPERATIONS (Cont.)**

10/19/66	<ol style="list-style-type: none"> <li>1. strobe lights inoperative</li> <li>2. magnetometer erratic</li> </ol>	<ol style="list-style-type: none"> <li>1. broken connector</li> <li>2. interference from subbottom profiler</li> </ol>
	<ol style="list-style-type: none"> <li>3. no focus on TV camera</li> </ol>	<ol style="list-style-type: none"> <li>3. flooded cable</li> </ol>
10/24/66	<ol style="list-style-type: none"> <li>1. strobe lights out of synch.</li> <li>2. no photos on one camera</li> </ol>	<ol style="list-style-type: none"> <li>1. long, impregnated cables</li> <li>2. camera flooded</li> </ol>
1/9/67	<ol style="list-style-type: none"> <li>1. partial photo coverage</li> </ol>	<ol style="list-style-type: none"> <li>1. film advance erratic</li> </ol>
2/14/68	<ol style="list-style-type: none"> <li>1. random strobe firing</li> </ol>	<ol style="list-style-type: none"> <li>1. voltage regulator malfunction</li> </ol>
8/4/68	<ol style="list-style-type: none"> <li>1. magnetometer inoperative</li> </ol>	<ol style="list-style-type: none"> <li>1. low resistance between leads due to salt water leakage in hull penetrator</li> </ol>
8/9/68	<ol style="list-style-type: none"> <li>1. side-scan sonar marginal</li> </ol>	<ol style="list-style-type: none"> <li>1. acoustic, electrical and mechanical noise generated by other systems</li> </ol>
8/10/68	<ol style="list-style-type: none"> <li>1. side-scan sonar failed</li> </ol>	<ol style="list-style-type: none"> <li>1. high temperature and humidity causing over-load actuation</li> </ol>
<b>BEN FRANKLIN</b>		
6/30/69	<ol style="list-style-type: none"> <li>1. SVSTD data incorrect</li> </ol>	<ol style="list-style-type: none"> <li>1. temperature sensitive component in logic unit</li> </ol>
7/15/69	<ol style="list-style-type: none"> <li>1. subbottom profiler inoperative</li> </ol>	<ol style="list-style-type: none"> <li>1. overload to power amplifier probably caused by external leak in hull penetrator</li> </ol>
	<ol style="list-style-type: none"> <li>2. transmissometer failed</li> </ol>	<ol style="list-style-type: none"> <li>2. outboard electronics flooded</li> </ol>
7/16/69	<ol style="list-style-type: none"> <li>1. magnetometer failed</li> </ol>	<ol style="list-style-type: none"> <li>1. ruptured diaphragm in magnetometer head</li> </ol>
	<ol style="list-style-type: none"> <li>2. 70-mm camera system malfunction</li> </ol>	<ol style="list-style-type: none"> <li>2. strobe cable splice flooded</li> </ol>
7/14/69 - 8/14/69	<ol style="list-style-type: none"> <li>1. SVSTD data not continuous</li> </ol>	<ol style="list-style-type: none"> <li>1. magnetic tape takeup occasionally uneven</li> </ol>

and causes of instrument failures on several different submersibles encountered by the Naval Oceanographic Office from 1966 to 1969. From these and other frustrations grew the realization of the need to develop dependable, safe and operationally applicable instruments and work tools.

Considering the numerous obstacles to instrument development and application, it is surprising that any were successful, but through desire and necessity a wide array of scientific equipment has been employed. The variety is so great, indeed, that it verges on the encyclopaedic to describe all of them. Instead, an overview of the more or less successful instruments is given. In some instances these devices were used merely as part of a test and evaluation program to

determine the feasibility and desirability of conducting various measurements from submersibles.

The scientific instruments discussed below are those described in various technical journals or special reports. Undoubtedly, there are other instruments which were employed on one or more tasks, the details of which are not available. Hence, the instrument tabulation is not truly comprehensive, but serves as an indication of the approaches taken and the potential thus provided for using submersibles in ocean endeavors. A most comprehensive and detailed description of hand tools and mechanical accessories for submersibles is given by Winget (6). For the potential designer and user of submersible tools this report is recommended.

For the sake of convenience, the different types of submersible instruments are separated into three categories: Surveying, research and engineering. The three are not mutually exclusive and there is much overlap of tasks and tools.

## SURVEY INSTRUMENTS

An oceanographic survey may be defined as a mission to determine the spatial and/or temporal variations in one or more environmental parameters. It may also include collection of samples. Surveys generally establish what, where, how many and what size. Research, on the other hand, answers "why." Engineering missions encompass such tasks as the inspection, repair or salvage of a piece of hardware or other artifact. Inspection of cables, pipelines or recovery of equipment are examples of an engineering mission. The overlapping of instrumentation can easily be seen from the fact that, at one time or another, all of these tasks may require the use of tape recorders, cameras, manipulators or samplers. From 1965 through 1970 the U.S. Naval Oceanographic Office conducted surveying operations with several different submersibles to provide design and performance specifications and operational techniques for oceanographic surveying instruments. The primary emphasis of this project was toward military oceanographic surveys, the goals of which are sometimes at variance with academic or commercial surveys, but the techniques and instruments used are similar. Because this was the only major effort to test and evaluate the use of the manned submersible and contemporary equipment in undersea surveying, the results of this work are taken to represent current instrument capabilities.

Initially, the Oceanographic Office started with the small *PC-3B*; thence to the larger *ALVIN*; *STAR III*; *DEEPSTAR 4000*; *ALUMINAUT* and finally, *BEN FRANKLIN*. By the time of the Gulfstream Drift (July 1969), the project had resulted in the design and assembly of an on-board instrument surveying capability equal to that of a 280-foot survey ship of the AGS class. The *BEN FRANKLIN* instrument suite during the Gulfstream Drift (7) is used as the prototype

description of a manned submersible survey instrument capability. Full details of these instruments are contained in reference (8). Table 11.2 presents the weight and dimensional characteristics.

### Water Column

The attempt to establish the what, where and how of many oceanographic surveys commences at the outset of a dive. Although the survey may be geological in scope, the descent to the bottom is not spent leisurely, because journeys through hydrospace may, at any time, provide some unusual observations through the viewport. A suite of water sensing instruments was developed to supply complementary data for observations and to augment the basic store of oceanographic data.

#### a. Water Sensor Pod: (Figs. 11.3 & 11.4)

**Operation:** The salinity, temperature, sound velocity, and depth sensors are in an underwater housing functioning continuously and are scanned sequentially by a recorder. A fifth data word is generated by a logic element which is the sequential time word. Eleven other data channels are available for auxiliary inputs into the recorder. All 16 data channels are scanned by the tape recorder every 2 seconds. Any of the four parameters measured by the WASP sensors may be monitored on a Nixie display.

#### **Data:** (Bisset-Berman Model)

Salinity	30 to 40 ppt $\pm 0.04$ ppt
Temperature	$-2^{\circ}$ to $+35^{\circ}$ C $\pm 0.03^{\circ}$ C
Sound Velocity	1.4 to 1.6 km/sec $\pm 0.14$ m/sec
Depth	0-6100 m $\pm 0.25\%$ (full scale)
Time	6-24 hr $\pm 0.01\%$ (full scale)

#### b. Dissolved Oxygen: (Fig. 11.5)

**Operation:** The sensor is a polarographic electrode. An oxygen permeable membrane covers the sensor head. Oxygen diffusing through the membrane generates a small electric current. The sensor responds to oxygen partial pressure, but use of temperature-compensating circuitry allows calibration in parts per million of dissolved oxygen by weight.

**Data:** (Beckman: Minos DOM PN 148250) Sensor output is converted to frequency in a format compatible with the recording unit of the water sensor pod or other recording and display units.



TABLE 11.2 WEIGHTS <sup>1</sup> AND DIMENSIONAL<sup>2</sup> CHARACTERISTICS OF SURVEY INSTRUMENTS

	Sensor		Digitizer		Nixie Display		Recorder	
	(Wt)	(Dim)	(Wt)	(Dim)	(Wt)	(Dim)	(Wt)	(Dim)
Water Sensor Pod (Bisset-Berman)	98 (air) 80 (wat)	25x7	30	7x19x13	5	4x7x8	30	7x19x13
Ambient Light Meter (A.C. Electronics)	50 (air) 15 (wat)	15x4			(Meter Display) 15	5x10x19		
Light Transmissometer (Hydro Products)	22 (air) 5 (wat)	60x5			(Power Supply & Readout) 8	12x8x7	(Rustrak) 5	4x6x6
Current Meter (Hydro Products)	20 (air) 5 (wat)	27x10			(Meter Display) 8	8x5x4	5	4x6x6
Oxygen Monitor (Beckman)	15 (air) 7.5 (wat)	3½x19			(Terminal Unit Readout) 13	7x19x5 3/8	5	4x6x6
35mm Camera (EG&G)	70 (air) 15 (wat)	31x9	(Control Box) 10	11x8x4				
Strobe (250 W/sec) (EG&G)	54 (air) 38 (wat)	32x5						
Side Scan Sonar (EG&G)	26 (air) 6 (wat)	36x4					(Strip Chart) 90	11x33x18
Sub-Bottom Profiler (O. R. E.)	99 (air) 55 (wat)	19x19x14					(Power Supply/Strip Chart) Recorder 30	14x19x12
70mm Camera (Hydro Products)	28 (air) 8 (wat)	24x8	(Control Box) 10	9x6x6				
Magnetometer	(Varian) 20 (air) 8 (wat)	20x6			(Counter-Barringer) 12	19x10x6	(Strip Chart) 20	19x12x14
Gravity Meter (LaCoste & Romberg)	100 (air)	20x19x48			(Meter Display) 150	36x36x36		

<sup>1</sup>pounds

<sup>2</sup>inches

Range: 0 to 15 ppm oxygen  
 Depth: 3,000 meters  
 Accuracy: ± 3% of reading  
 Temperature Range: -2° to + 35° C

Output: FM signal 5 kHz to 6.5 kHz,  
 0 to 5 VDC  
 Power: 115 VDC, 15 amp

c. **Ambient Light:** (Fig. 11.5)

**Operation:** Natural light transmitted



Fig 11.3 Bissett-Berman (Plessey) water sensor pod with pressure housing removed. Components in cage measure salinity, temperature, sound velocity and depth. (WHOI)



Fig. 11.4 Water sensor pod logic and recorder components (above and below). (WHOI)

down from the sea surface is caught by a cosine collector, passed through a narrow band interference filter with transmission peak matching that of seawater and measured by a photomultiplier. A temperature-compensating circuit reduces the effect of temperature on the photomultipliers. The resulting measurements of light flux are recorded on an open channel of the water sensor pod.

**Data:** (A.C. Electronics Model) Under static solar radiation conditions at the sea surface, the change in light flux with depth is a measure of the diffuse extinction coefficient of the seawater. Also, at levels below which natural light can penetrate, the luminescence of passing biological life can be monitored.

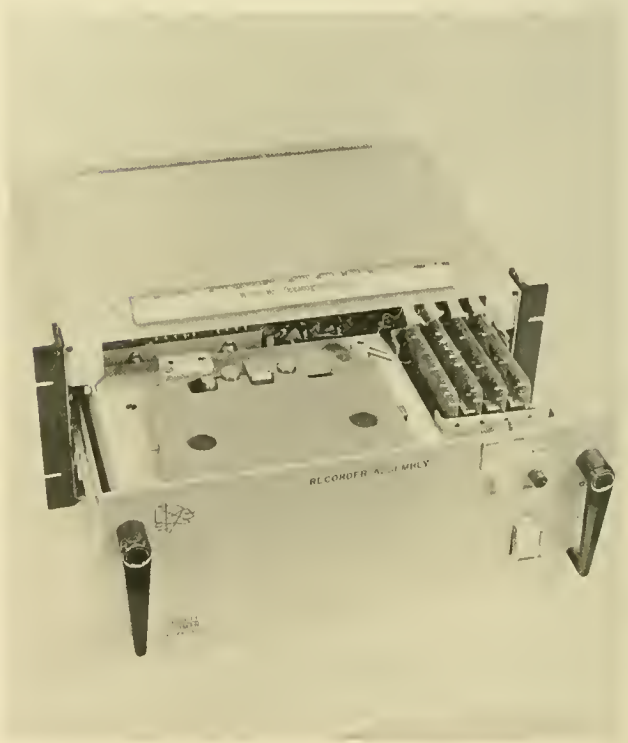

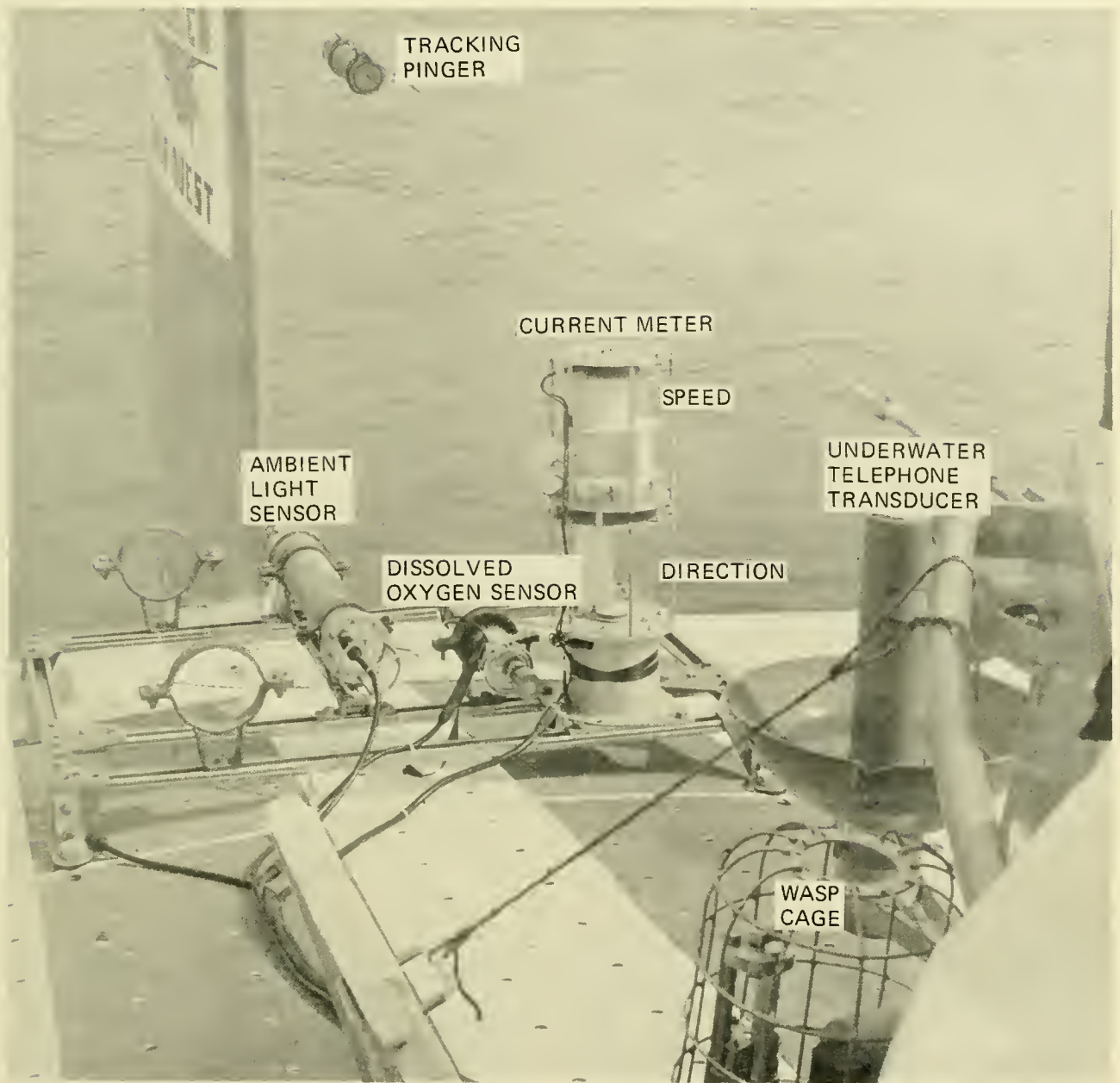

Fig. 11.5 Ambient light meter, dissolved oxygen sensor, current meter and other equipment aboard DEEP QUEST.

Light flux: 0.225-9,000 picowatts/cm<sup>2</sup>.

d. **Light Transmission:**

**Operation:** A collimated light beam of known intensity is passed through a baffled tube. At 1-meter water distance the residual light is monitored by a photocell. The output of this photocell is dependent on the amount of light transmitted through the 1-meter

path of seawater and is a measure of water clarity (or turbidity).

**Data:** (Hydro Products Model) The taut band meter in the readout unit displays the water clarity in terms of percent of transmission.

Alpha Range: 0.1 to 2.2 1n/m  $\pm 3\%$  at mid-range.

e. **Water Currents:** (Fig. 11.5) Accurate measurement of water currents from a submersible is conducted when the vehicle is bottomed. Because ocean currents are variable in time and space and the submersible data of very short time duration, the data thus obtained is representative of only the period and precise location of the measurement. Inaccuracies in submersible heading and speed while underwater, and the small relative magnitude of currents, preclude computing true from apparent current velocity as is done with wind velocities on ships. Drifting within the current and being tracked from the surface, as was **BEN FRANKLIN**, can be a method of measurement, but it is too expensive and restricted for normal operations. Similarly, drifting and measuring one's speed and direction with Doppler sonar is accompanied by the same restrictions. Consequently, this instrument has been affixed to many submersibles owing to its ease of installation and operation, and its relatively low cost.

**Operation:** Current speed is monitored by a Savonius rotor with 10 magnets equally spaced on a perimeter base. A magnetic switch counts the pulses per time interval and the speed is registered on a taut band meter such that 83.5 rpm equal 1 knot. Current direction is sensed by a vane which is connected magnetically to a compass. Allowable inclination from the vertical is 20 degrees.

**Data:** (Hydro Products Model) Absolute current speed (in knots) and direction (relative to magnetic north) are graphed continuously with time.

Current Speed: 0.1-6.0 knots  $\pm 2\%$

Current

Direction: 0-360 degrees  $\pm 7$

## Bottom

Ocean bottom information is required for a variety of reasons. For example, to design, install and maintain cables, the following bottom and near bottom information is required: Nature and size of bottom materials, slope, strength, presence of artifacts (wrecks, cables, pipelines), sediment stability, currents and, if the cable is to be buried or plowed under, whether or not solid rock out-

crocks or horizons underlay an apparently soft ocean floor which may prohibit plowing. While **BEN FRANKLIN** carried no bottom sampling instruments on its drift mission, such capability is mandatory for a surveying submersible. Hence, various bottom sampling devices will be included in this section and will serve to represent those capabilities developed for research and engineering.

a. **Stereophotography System:** (Fig. 11.6)

**Operation:** To obtain the widest possible coverage, two cameras and two strobes were mounted in tandem with only minimum overlap of their fields of view. Stereo pairs are achieved by overlapping successive photographs in each camera. Each side can be fired in succession or independently. Each camera is pre-focused so that the bottom can be photographed at ranges from 15 to 50 feet. The minimum time between exposures for each camera is 4 seconds.

**Data:** (EG&G Model 207) This system can supply 3,300 stereo-pair photographs of the sea floor without reloading.

**Adjustments:** f/4.5 to f/22; 1/10-1/200 sec.

**Exposure rate:** 4, 6, 8, 10, 12, and 24 seconds and manual.

b. **Side Scan Sonar:** (Fig. 11.7)

**Operation:** Each transducer emits a 0.1-millisecond, 110-kHz pulse at a regular interval (0.1, 0.2, or 0.4 sec). The beam pattern is only 1 degree in the horizontal plane but approaches 60 degrees in the vertical plane. As the submersible advances, echoes from acoustic reflectors in the insonified area are recorded on a strip chart.

**Data:** (EG&G Model) The acoustic map resulting from this sonar provides a three-dimensional facsimile of the prominent relief features on both sides of the submersible's path to ranges of 250, 500 or 1,000 feet. Resolution of 1/250 of full scale is normally realized.

c. **Subbottom Profiling:** (Fig. 11.8)

**Operation:** The transducer emits a pulse of no less than 105 decibels (on axis) of 5-kHz acoustic energy in a 50-degree beam towards the bottom. Portions of this pulse are reflected at each interface encountered and these echoes are picked up as they arrive back at the transducer. A synchronized blade on the recorder registers the arrival of each echo on wet recording paper. The sweep

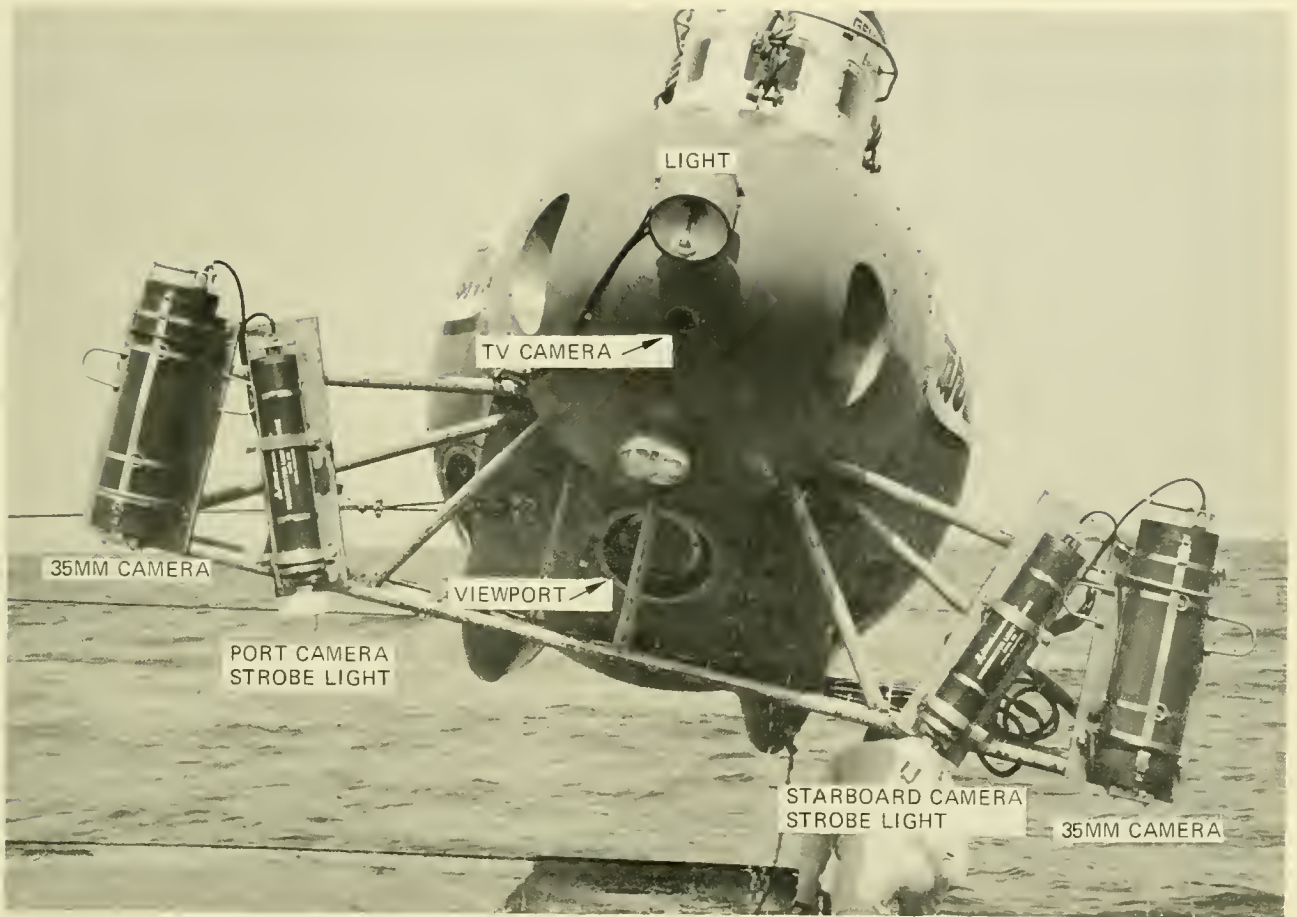

Fig. 11.6 Stereophotograph system on STAR III. The entire system is jettisonable. (NAVOCEANO)

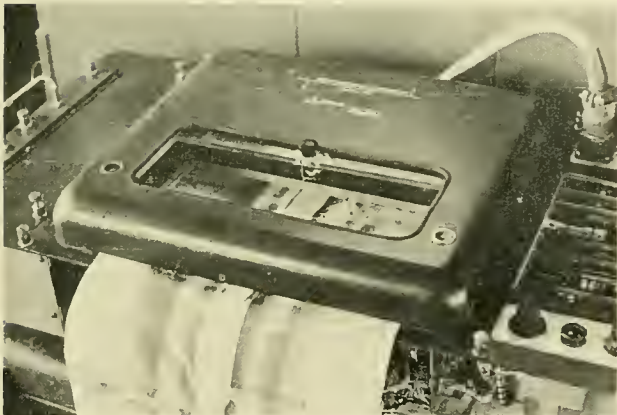

Fig. 11.7 EG & G side scan sonar recorder and transducer. (NAVOCEANO)

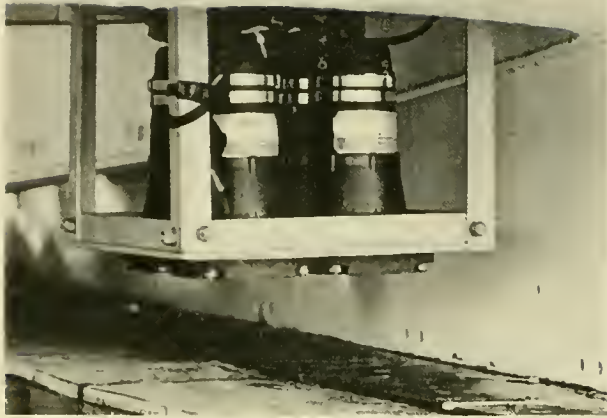
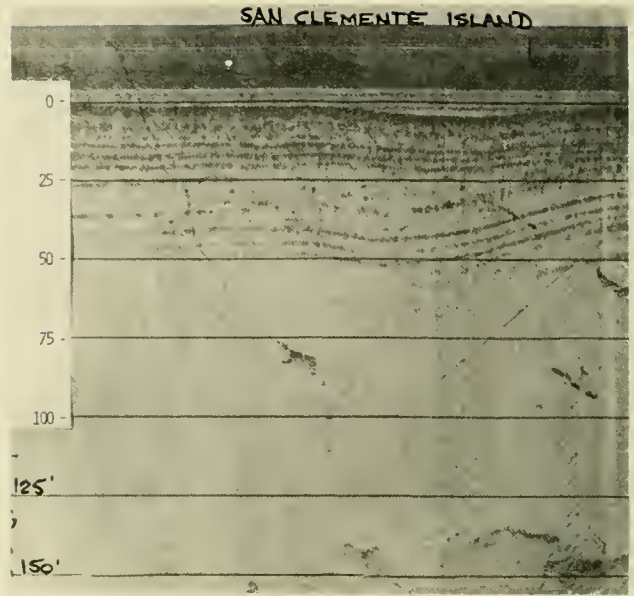

Fig. 11.8 ORE subbottom profiler, transducers and recorder. (NAVOCEANO)



rate and paper speed in the recorder are selectable.

**Data:** The system (O.R.E. Model 1200 Subbottom Profiler) provides a record of the ocean bottom and its substructure under the submersible's track.

**Pulse Length:** 0.3, 0.5, 1.0 and 2.0 milliseconds.

**Sweep Rate:** 50, 100, and 200 sec.

**Paper Speed:** 100, 200, 300, and 500 scans/in.

#### d. Bottom Samples:

The floor of the ocean may range from soft, soupy, mud plains (unconsolidated) to hard rock (consolidated) cliffs. Between the two ranges is a variety of combinations. To obtain samples of both consolidated (hard) and unconsolidated (soft) materials a variety of instruments has been developed and used. The reader is urged to consult reference (6) for a detailed and comprehensive discussion of these devices.

##### 1. Unconsolidated Sediments

**Cores**—(Fig. 11.9) By pressing a hollow, narrow cylindrical tube into the sediment with the vehicle's manipulator, sediment samples up to 3 feet in length have been obtained. An exploded view of this de-

vice is shown in Figure 11.10. Benthos Inc. (10) manufactured a 6-barrelled piston corer specifically for *DEEP QUEST* which drives a 4-foot-long, 2.6-inch-diameter corer into the sediment with a pair of shock cords. A drive shaft retracts the core tube from the sediment.

**Scoops**—(Fig. 11.9) Anything from a tin can to a specially designed scoop has been used with a manipulator to obtain a shallow sample of the bottom.

**Dredges**—(Fig. 11.9) A steel mesh dredge may be mounted under the bow of the submersible and by running along the bottom the vehicle can scoop up large fragments while sifting out the fines.

**Grabs**—Merely picking up and storing of rock fragments is accomplished through the vehicle's normal grasping hand. Using both manipulators *DEEP QUEST* retrieved a 328-pound rock from 2,800 feet.

##### 2. Consolidated Sediments

**Drills**—Hard rock rotary drills have been developed and used by Woods Hole Oceanographic Institution and International Hydrodynamics Corporation (11), and are capable of taking 4-inch  $\times$  0.75-inch and 10-inch  $\times$  5/8-inch cylindrical cores, respectively. The WHOI corer (Fig. 11.11) is held in the manip-

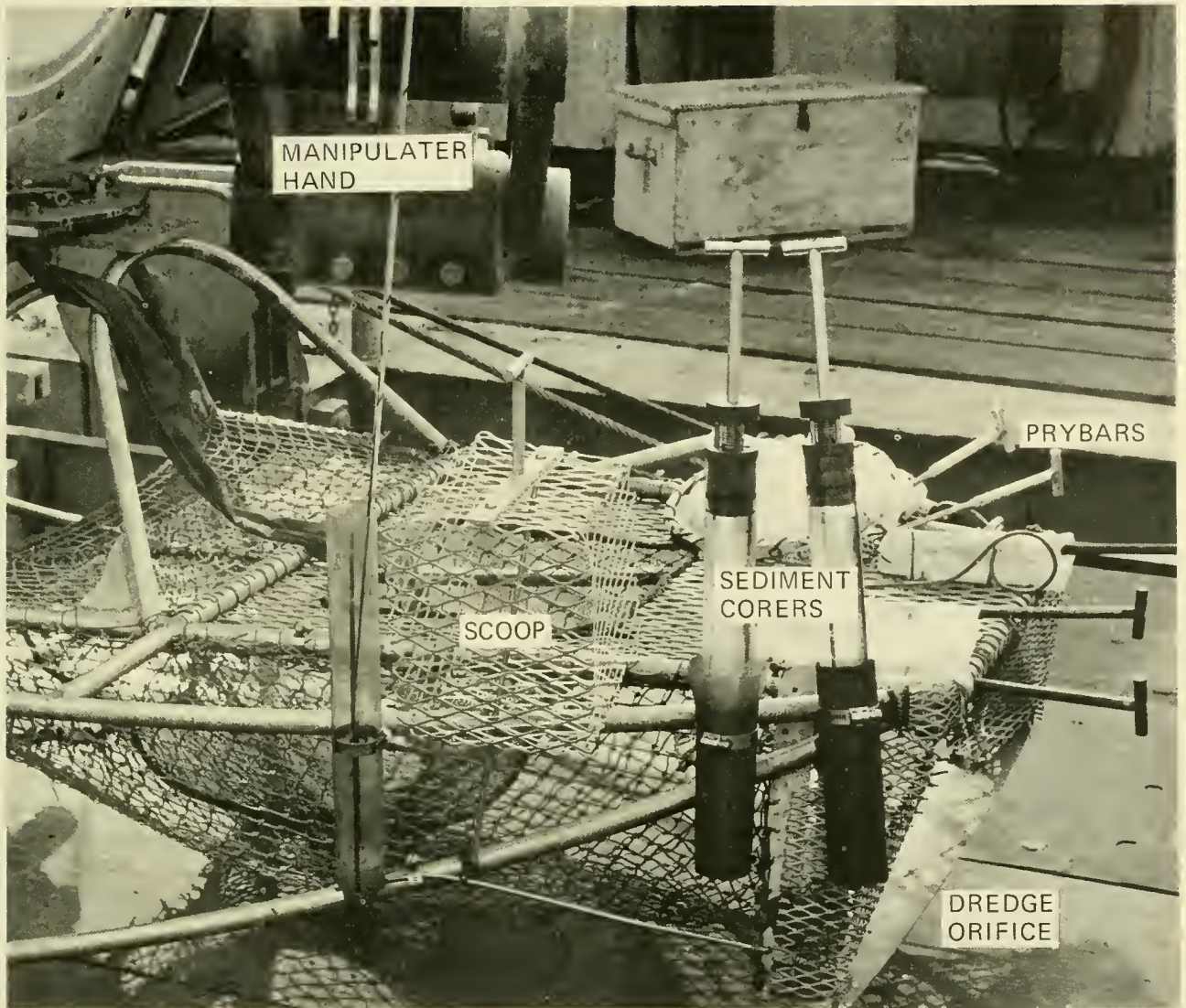

Fig 11.9 ALVIN's jettisonable bottom sampling aluminum brow. All the designated sampling devices are employed by the manipulator which is also used to collect grab samples. The dredger is employed by making ALVIN negatively buoyant and pushing the dredge into the sediment. (WHOI)

ulator while the diamond cutting bit rotates and water flows through the drill to flush away mud generated through cutting. At desired penetration, drill rotation is reversed, as is water flow, and the drill assembly is rocked slightly to assist in seizing and breaking off the core specimen. The core is held in the hollow corer by the reverse water flow until ejected into a sample container by once again reversing the flow of water.

The tethered **GUPPY** employed a more direct, brute-force approach to hard rock cor-

ing. A Schlumberger Side Wall Corer was installed outside the pressure hull and aimed horizontally to fire hollow bullets into an outcrop. The resulting sample is about 1 inch in diameter by 2.5 inches in length. The corer has a capacity to take 24 individual samples on one dive. Mr. William Watson, of Sun Shipbuilding and Dry Dock, relates that several hundred samples were collected in this manner, but he acknowledges that an assessment of the effects on viewports and other structures is in order. The pressure wave



Fig. 11.10 Exploded view of plastic core tube, quiver and closure stopper. (WHOI)

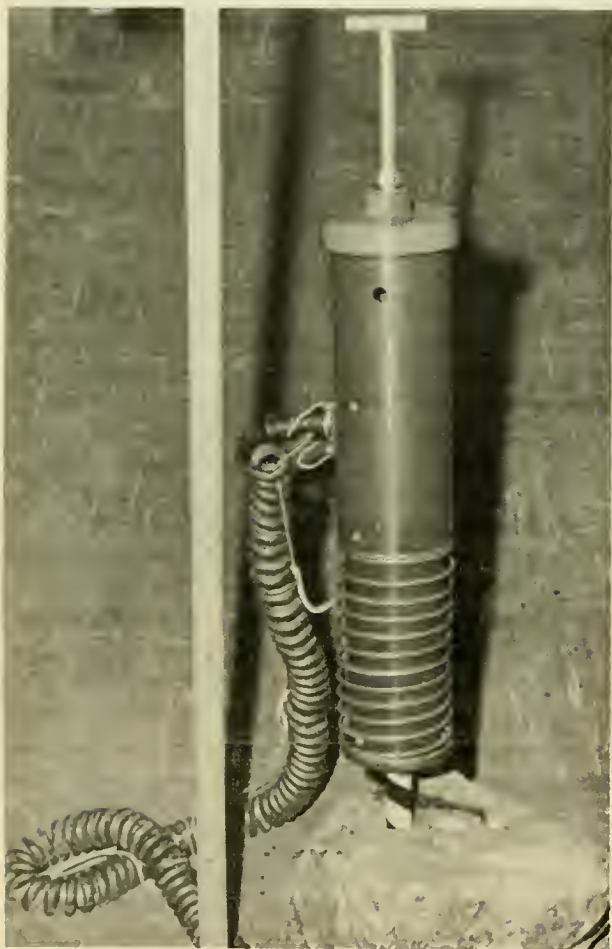

Fig. 11.11 ALVIN's hard rock rotary corer. (WHOI)

from the charge was considerable and at 600 feet it was felt all over the submersible.

**Pry Bars and Splitters**—A wide variety of pries and splitters has been made which conforms to a specific vehicle's manipulator hand and are used to pry or split samples from hard rock.

## Geophysical Measurements

### Magnetics:

**Operation:** Since submersibles are made primarily of steel, magnetic measurements must be made so that the sensing device is beyond the influence of the vehicle. In the case of *ALUMINAUT* a boom only 8 feet long provided sufficient isolation (12), while the steel-hulled *BEN FRANKLIN* required that the sensor be buoyed in a glass sphere 150 feet above the submersible (Fig. 11.12). The total magnetic field strength is indicated by measuring the precession rate of polarized hydrogen nuclei in the sensor. The generated frequency is amplified, counted, and displayed in gammas and recorded on a strip chart or digitized.

**Data:** Measures the total ambient magnetic field with respect to time over a selectable range of 20,000 or 100,000 gammas to an accuracy approaching  $\pm 1$  gamma.

### Gravity:

Two approaches to gravity measurements have been taken, one with the submersible bottomed and stable, and the second with the submersible underway. In the first case, a La Coste & Romberg gravimeter (Model 5)





Fig. 11.12 Magnetometer sensor and glass float on *BEN FRANKLIN*. An explosive guillotine device served to cut the 150 ft of cable in the event of an emergency (NAVOCEANO)

was used aboard *DEEPSTAR 4000* (13), *ALVIN* (14) and others to obtain average deviations from station to station. In the second case, an Askania gravity meter (Fig. 11.13) was used aboard *ALUMINAUT* and a La Coste & Romberg meter aboard *BEN FRANKLIN*. A comprehensive and detailed report of the techniques and merits of conducting gravity measurements from submersibles is presented in reference (15).

**Operation:** The gravity sensor is suspended in a gimbal and allowed to hang level. It consists of a mass which is a damped hinged beam, a spring with adjustable tension and a photo-cell to measure the beam's motion. Variations in gravity upset the balance of the set spring tension and weighted beam. The resultant motion is caused by change in spring tension, which has been calibrated to indicate a change in gravity.

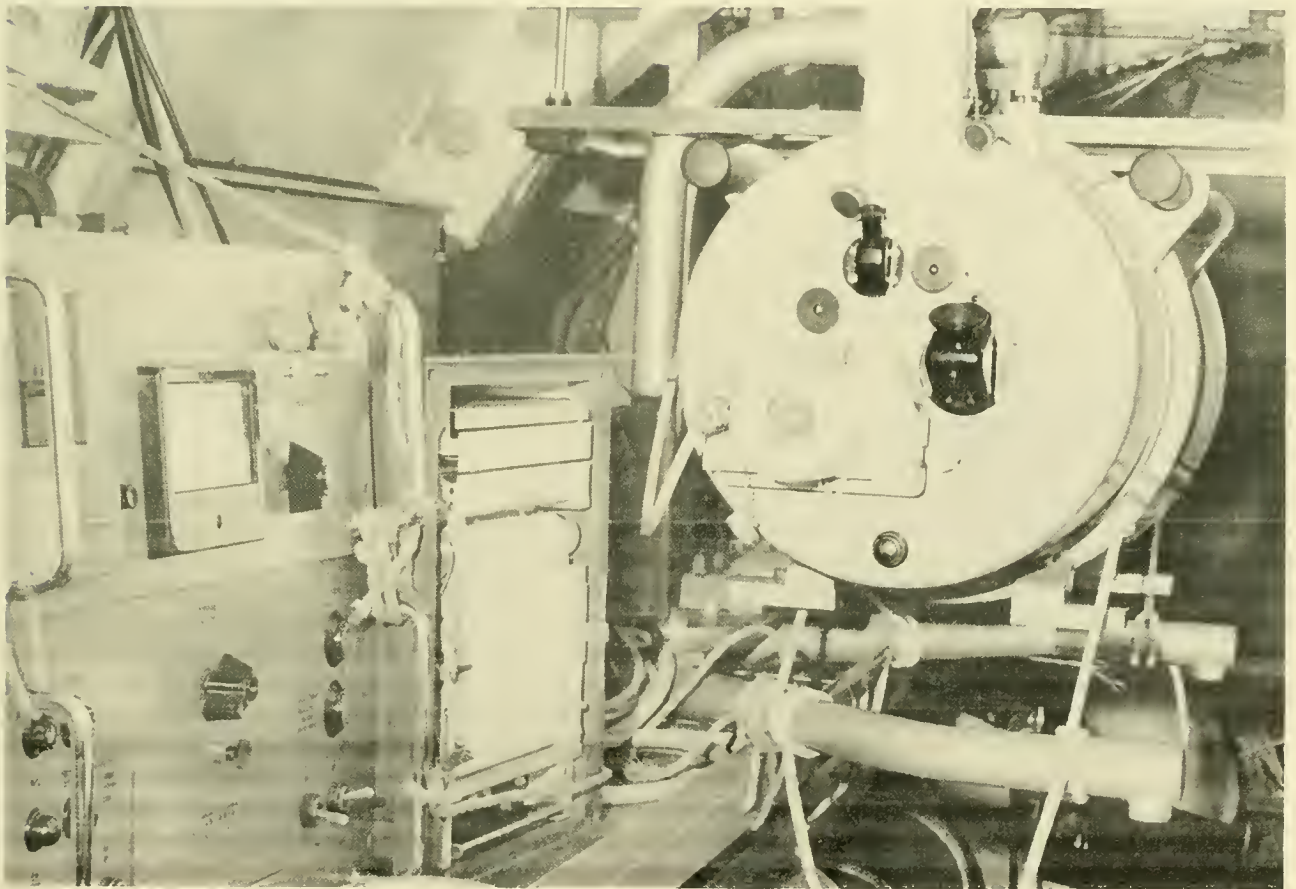

Fig. 11.13 Underway gravity measurements were taken with this Askania gravity meter aboard *ALUMINAUT*. (NAVOCEANO)

**Data:** The instrument is a relative gravity meter and must be calibrated at a known station. It is used only in the slope mode, *i.e.*, the rate of change of the beam position is recorded with time on a strip chart. The generated slope is read as a change to the spring tension of dial divisions. The dial divisions are then converted manually to mgal (0.001 cm/sec<sup>2</sup>). The range is up to 12,000 mgal  $\pm$ 1-2 mgal.

### Photography

A variety of cameras and techniques for their employment has been devised for use aboard specific vehicles (Fig. 11.14). Basically there are two options: Mounting the camera outside of the pressure hull, or photographing through the viewport. On *BEN FRANKLIN* two 70-mm cameras and a television camera were mounted externally on a pan and tilt mechanism forward. The television camera was monitored internally and served to aim the 70-mm cameras. A strobe light furnished the lighting. A second system en-



b)



a)

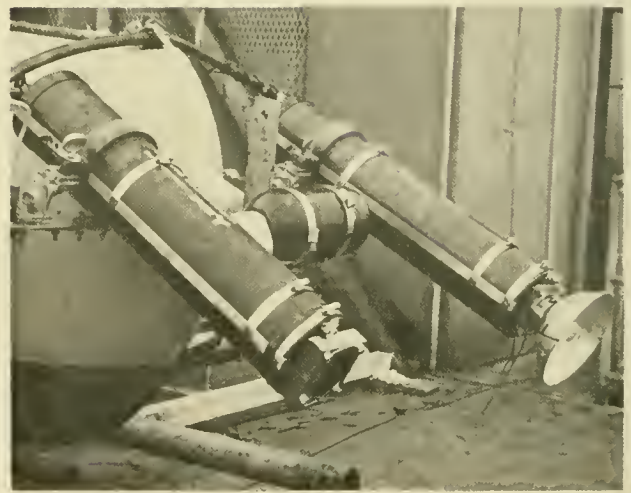

c)

Fig. 11.14 Various still camera and strobe configurations: a) *STAR III* with plankton sampler and cameras arranged for stereophotographs, b) *STAR II* and c) *PC-3B* with single camera and strobe, d) Pan/Tilt unit with two 70-mm cameras, a TV camera for aiming and a light. (a & b USNUSL, c & d NAVOCEANO)

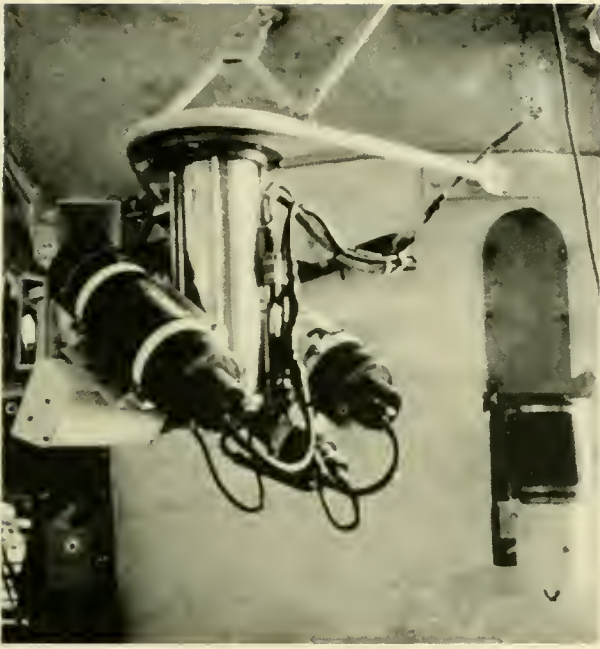

d)

tailed photographing through a forward viewport with a hand-held 70-mm camera (Hasselblad) which was electrically connected to an external strobe light. This latter system allowed photographing of both small organisms which clustered near the viewport and of larger features. In other vehicles thru-port photographs have been obtained by using external flood (viewing) lights for illumination *in lieu* of a strobe light.

**Operation:** The stobe is positioned to light the field of view as seen from a particular viewport. The 70-mm cameras, with corrected normal angle lenses, are set and calibrated to take stereophotographs of this field of view on command from a control box. Aperture settings from  $f/2.8$  to  $f/16$  are set prior to installing the cameras in their housings with focus distances available from 18 inches to infinity. The shutter is triggered from the control box and the film advances automatically in 1 second. The strobe light (250 W/sec) requires a 3-second cycle time. The number of frames exposed is counted by the control box and any picture can be "fogged" from the control box for later reference.

**Data:** (Hydro Products Model 750) 450 Stereo pairs. 70 mm B&W or color.

Cine or motion pictures have been ob-

tained through the viewports with 8-mm and 16-mm cameras of virtually every make and model using viewing lights for illumination. A brief, but highly informative report on the problems, equipment and techniques involved in photography specifically from submersibles is given by *DEEPSTAR 4000's* pilot R. Church (16). For a broad and detailed description of underwater photography and associated equipment reference (17) is recommended. Additionally, Eastman Kodak published a brochure *Bibliography of Underwater Photography and Photogrammetry* (Kodak pamphlet P-124) which presents 280 references on this subject published from before 1950 through 1968. The Eastman brochure can be obtained from their Department 942, Rochester, New York 14650.

Compared to the exacting nature of the preceding instruments and the candid eye of the camera, it is quite legitimate to question the need for man. It is not only possible, but a well demonstrated fact that all of these instruments can be packaged and dispatched on the end of a cable to perform as well as they do strapped to a submersible. The scientific advocates of submersibles are frequently plagued by their engineering associates who question the value of data that has no numbers, calibration curves or range of accuracies. Most frustrating to the naturalist is the engineer's uncanny ability to best him with electronics in everything but knot tying. To partially justify the human eye undersea Figure 11.15 is presented. This drawing was made by Mr. Andres Pruna, formerly of the U.S. Naval Oceanographic Office, during *PC-3B's* operations on a cable route survey in the Bahamas. The depths and distances were obtained from instruments, but the panoramic view, the perspective and the accompanying descriptions came from the human occupant's ability to see and relate to another human what he observed. Undoubtedly, photographs could have been taken (and many were) to show precisely what artist/biologist Pruna has captured on his sketch pad. But photographs show the letter of the law, the observer captures its spirit, and if we are to truly understand the ocean, then its spirit as well as its anatomy must be understood.

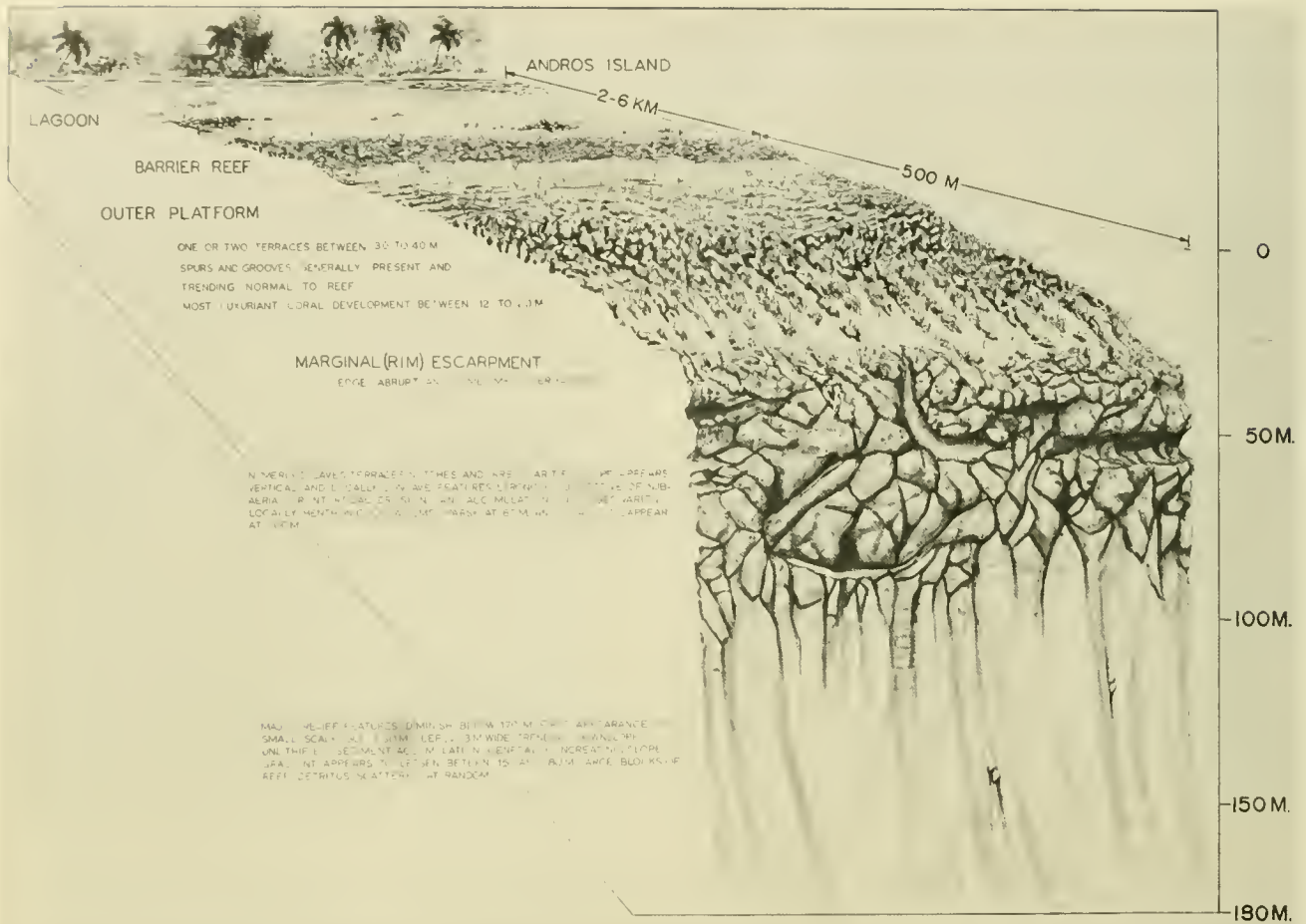

FIGURE 5 ANDROS ISLAND TO MARGINAL ESCARPMENT, TYPICAL BOTTOM FEATURES

Fig. 11 15 Andros Island to marginal escarpment, typical bottom features. (Andres Pruna)

## RESEARCH INSTRUMENTS

The instruments used for oceanographic research from submersibles range from discarded beer cans to sophisticated electronic devices. In the former case, the amount of sediment accumulation atop a "flip top" beer can was estimated by R. F. Dill from the *DIVING SAUCER* in 1965. Since the introduction of this type of can into the particular area was known, estimate of settlement versus time was attained. Between beer cans and sophisticated electronics are perhaps 2,000 dives made for research purposes; and, the equipment used varies almost with dive-to-dive frequency.

The greatest variety of research instrumentation originated within the Navy Electronic Laboratory's deep submergence program beginning with *TRIESTE I* in 1959 and

terminated with *DEEPSTAR 4000* in 1968. In the course of these 10 years NEL conducted research dives in support of biology, geology, acoustics, physics and geophysics. Each diving scientist, of which there were some 20, equipped the bathyscaph or the submersible with off-the-shelf or newly designed equipment suitable to his task. Several hundred dives were made and the different equipments are legion, and, in many instances, one of a kind for a particular dive.

On the east coast of the U.S. the Navy's Underwater Sound Laboratory in New London was involved with acoustic research and also designed a variety of instruments to measure and observe the behavior of underwater sound.

Other countries—including Canada, France, Russia and Japan—were also active

during the late 50's and 60's, but not to the extent found in the U.S. Where the Japanese, Russian and French were interested for the most part in fisheries and biology, U.S. interests were more catholic (1). The result of these international efforts was to add an even wider variety of instruments to the research inventory. To gain an appreciation of the widespread nature of these research efforts, the report of Ballard and Emery (1) is recommended and their exhaustive bibliography may be consulted for specific details.

Owing to the diversity of research equipment and its one time application, each instrument will not be described. Instead, a tabulation of instruments applied to research within various disciplines will serve as being representative; this is presented in Table 11.3. In the same vein, Figures 11.16 through 11.19 are included to present an idea of the instruments developed, versatility of submersibles and the imagination of their users to adapt over-the-side instruments to deep submergence applications.

In spite of a variety of instruments, the majority of research dives relied primarily on human observation and photographic documentation, and secondarily on the collection of samples. The reasons for this reliance are worth considering. According to Ballard and Emery (1), of 346 scientific articles published in 1970 concerning submersibles in oceanography, 208 (57%) dealt with biology, fisheries and geology, while the remainder dealt with physical oceanography, acoustics, geophysics and other kinds of missions. Marine geology and biology from submersibles are, by and large, descriptive sciences. It follows that observations and photography are the main investigative techniques. A recent example of this dependence on photo/visual observations is the MUST program's 260 dives with eight different submersibles (Sept. 1971-Dec. 1972) where photography and vision were the primary instruments. In addition to the collection of geological samples, one must conclude, therefore, that exploration of the Lewis and Clarke variety—observing and collecting—will play the major part of *in situ* undersea research for some time to come.

## ENGINEERING/INSPECTION/ SALVAGE INSTRUMENTS

Within this category are grouped submersible tools and instruments used to accomplish tasks or gather information not related solely to an understanding of the natural environment.

Basically, engineering/inspection/salvage missions and their most commonly used instruments and devices can be grouped as follows:

MISSION	PHOTOGRAPHY	TV	MANIPULATORS	LIFT DEVICE	CABLE CUTTERS	WATER JET
<b>Inspection</b>	X	X				
<b>Salvage</b>	X		X	X	X	
<b>Excavation</b>			X			X
<b>Hardware</b>						
<b>Adjustment</b>			X			
<b>Observation</b>	X	X				
<b>Rescue</b>			X		X	
<b>Artifact</b>						
<b>Mapping</b>	X	X				

As with research instruments, none of the above is necessarily standard; each was developed or purchased to perform a particular task. The critical "instrument," however, is the human and his ability to assess the situation *in situ* and employ the vehicle to accommodate prevailing and changing circumstances. There are few, if any, precedents to follow in underwater work of this nature. Consequently, the successful mission is a reflection of the imagination and ingenuity of the personnel. A description of the tools and techniques employed in several of these tasks will serve to demonstrate this point.

### Ordnance Retrieval (Ref. 41)

The submersibles *PISCES I* and *III* were contracted by the U.S. Navy in 1969-70 to recover practice torpedoes from a 1,360-foot-deep test range in Howe Sound, British Columbia. A 47-kHz pinger allowed range authorities to track the torpedo to the bottom. With a hydrophone attached to its manipulator in the vertical upward position, *PISCES* used the same pinger for "homing in" on the torpedo. *PISCES* usually clamped smaller (less than 200-lb) torpedoes with its arm and

TABLE 11.3 RESEARCH DIVES AND INSTRUMENTATION

Submersible	Date	Max Depth (Ft)	Location	Task	Purpose	Instrument(s)	Ref
Aluminaut	1969	6178	Puerto Rico	Sedimentology	Study lateral variations in closely-spaced sediment cores	3-ft long plastic cores inserted by manipulator	33
Alvin	1966	5850	Bermuda Is.	Biology	Near-bottom organism sampling	Two plankton sampling nets on bow, manipulator actuated	18
	1966	2750	Bahama Is.	Optics	Underwater visibility tests	Black and gray targets on bow-mounted rack	14
	1966	3550	Bahama Is.	Soil Mechanics	Sediment bearing strength studies	Variiously configured concrete clumps dropped from surface and observed from submersible	14
	1966	4900	Bahama Is.	Geophysics	Gravity measurements at selected sites	LaCoste-Romberg Field Gravimeter	14
	1966	4900	Bahama Is.	Geology	Sub-bottom profiler evaluation	EG&G Sediment Probe/echo sounder system with 12-kHz transducer	14
	1966	4950	Bahama Is.	Acoustics	Determine magnitude of fluctuations in normal incidence bottom reflectivity data	12-kHz transducer and a calibrated receiving system	19
	1966	615	New England	Physics	Measure temperature microstructure at thermocline	Manipulator-held 5-ft long rod with thermistors at each end	18
	1967	1789	Blake Plateau	Physico-Chemical	Measure small-scale temperature-salinity variations in water column and within sediment interstitial waters	Bottom probe to measure sediment resistivity; thermistor to measure water temperature	20
	1967	1832	Blake Plateau	Suspended Particles	Determine the nature and quantity of suspended material in the water column	Plastic water samplers closed by manipulators; TV-type test pattern target mounted on sample rack	20
	1971	800	Gulf of Maine	Soil Mechanics	Obtain measurements of sediment bulk density and penetration resistance	Nuclear (gamma) density probe and static cone penetrometer	21
Ben Franklin	1969	1800	Gulf Stream	Acoustics	To record ambient noise and bottom reflected sound signals from surface explosions	Externally-mounted hydrophone; internal 7-channel tape recorder	7
	1969	1800	Gulf Stream	DSL Studies	To record and measure backscatter from sound transmitted at varying frequencies and pulse lengths	3.5 and 12 kHz transducers, tape recorder and strip chart recorder	7
Deep Quest	1970	4068	Pt. Loma, Calif.	Soil Mechanics	Compare sediment bearing strength measurements obtained <i>in situ</i> vs. those obtained from cores	Diversified Marine Corp. Model SA-1040 Sediment Shear Measurement Device. Shock-cord-driven, 5-ft long sediment corers	21

TABLE 11.3 RESEARCH DIVES AND INSTRUMENTATION (Cont.)

Submersible	Date	Max Depth (Ft)	Location	Task	Purpose	Instrument(s)	Ref
Deep Quest	1972	4034	San Diego Trough	Soil Mechanics	Provide bottom sediment information for development of a geotechnical test area	Static cone penetrometer (4-ft penetration) and vane shear device (11.2-ft penetration)	24
DS-4000	1966	2700	Mission Beach Calif.	Geophysics/ Geology	Bottom reconnaissance and gravity measurements	Model "S" LaCoste—Romberg gravimeter	13
	1966	4000	Various off Calif. and Mexico	Acoustics	Attain information to derive accurate sound speed equations and anomalies	Fjarlie bottles (4 ea.) with reversing thermometers, Vibratrons (2 ea.) pressure depth gages, sound velocimeters (3 ea.), temperature probes (2 ea.) and one salinometer	26
	1966	2820	San Diego	Acoustics	Obtain <i>in situ</i> bottom data and samples to calculate accurate values of acoustic bottom loss	On an aluminum tube hanging from brow: 4 geophones to receive output from 6 electric blasting caps. Geophone output recorded on internal tape.	13
	1966	3978	Lausen Sea Mount	Physico-Chemical	Measure: Physical-chemical properties of seawater affecting sound; water motion near sea floor; sediment thermal structure.	Fjarlie bottles, temperature sensors, bottom temperature probe, savonius current meter	13
	1966	960	San Diego Trough	Bio-acoustics	Measure <i>in situ</i> target strength of Marine organisms	A 14-kHz transducer (5-degree cone width) was positioned to transmit and receive sound pulses; a 1-in. steel ball was placed in position to serve as a target reference strength	13
	1966	2448	San Diego Trough	Bio-acoustics	DSL investigations	"Fish Sturper" Biological sampling device	13
	1966	3378	San Diego	Acoustics	Determine <i>in situ</i> sound velocity and attenuation in upper sediment layers.	Three probes on a rigid frame, each holding a barium titanate transducer, were inserted into the sediment to a depth of 2 ft.	25
	1966	4080	San Diego	Radiation Measurements	Attain an ambient background gamma radiation profile of the water column for future comparison	A sodium iodide crystal photomultiplier mounted externally and a rate meter (counter) carried internally	13
1967	3300	Cozumel Is. Mexico	Currents	Observe and photograph current shear velocities through the use of dyes	A metal bucket (also serving as the anchor) containing a gasoline-filled clorox bottle and two dye cakes attached to a line between bucket and bottle was deployed by the manipulator	27	

TABLE 11.3 RESEARCH DIVES AND INSTRUMENTATION (Cont.)

Submersible	Date	Max Depth (Ft)	Location	Task	Purpose	Instrument(s)	Ref
DS-4000	1967	---	San Clemente, Calif.	Geology	Measure bottom slope and conduct geological reconnaissance	External lights (one pointing directly downward and one 45-degrees forward) were aligned by maneuvering the sub to where they both coincided on the sea floor; at this point the sub is horizontal to the slope and angle is measured internally	34
	1966	1197	San Diego	Soil Mechanics	Compare <i>in situ</i> vs. laboratory measurements of sediment shear strength	Vane shear apparatus coupled with 2 plastic core tubes	34
DS-2000	1971	---	San Clemente, Calif.	Mineralogical Survey	Determine the feasibility of <i>in situ</i> mineral surveys from submersibles	A Californium-252 neutron source was affixed to a 12-ft boom and used to activate a known sample, a radiation detector under the brow was used to measure the activated sample	36
Pisces I, II, III	1968	---	Northwest Canada	Ice Observations	Record back-scattering from underside of ice	12-kHz transducer pointing vertically upward with recorder inside pressure hull	35
	1968	---	Northwest Canada	Geology	Collect samples of bottom	Hydraulic hammer for breaking bedrock; hydraulic clam-shell grabber to obtain large blocks and boulders	35
	1972	---	Hudson Bay Canada	Geology	Collect samples of bottom	Hydraulically-driven, rotary, hard-rock corer taking cores 10-in length and 5/8-in diam.	11
	1970	---	Georgian Bay, Canada	Physico-Chemical	Conduct various water column measurements	Boom-mounted eH, pH, and oxygen/temperature sensor	23
SP-350	1965	940	San Diego	Acoustics	Obtain data on the spatial correlation of ambient noise	Geometrically-spaced hydrophones (6 ea.) suspended on bow-mounted rack	37
Star III	1966	2000	Western Atlantic	Acoustics	Measure reverberation characteristics of DSL	Parabolic acoustic reflector/transducer system on bow to insonify and record returns from DSL	40
Techdiver	1969	60	Canada	Biology	Quantitative survey of scallops on the sea floor	Wheel odometer suspended from sub. to measure distance and a recorder (manual) internally to count visual observations of scallops	38



TABLE 11.3 RESEARCH DIVES AND INSTRUMENTATION (Cont.)

Submersible	Date	Max Depth (Ft)	Location	Task	Purpose	Instrument(s)	Ref
Trieste I	1957	10496	Mediterranean	Acoustics	Measure ambient sound level vs. depth	Vertical and horizontal arrays of hydrophones; 4 receiving transducers	28
	1960	7500	Guam Is.	Gravity	Conduct bottomed gravity measurements	LaCoste-Romberg geodetic gravimeter Model G	29
	1960	18900	Guam Is.	Physics	Attain water temperature profile	Resistance bridge and reversing thermometer	29
	1961	3870	San Diego Trough	Currents	Investigate character of low-order-of-magnitude currents near-bottom.	Metal grid with heavy nylon yarn streamers attached. Camera to record angle of streamers for subsequent comparison against calibration curve	30
	1960	18900	Guam Is.	Acoustics	Obtain water sound speed and temperature measurements <i>in situ</i>	Sound velocimeters, Nansen bottles with reversing thermometers	31
	1957	1968	Mediterranean	Light Penetration	Study daylight extinction vs. depth	A photomultiplier tube inside a deep-sea camera housing mounted atop the bathyscaph's sail	32

blew ballast to surface. With larger torpedoes 1,500 feet of braided polypropylene line, buoyed at the surface, was secured to *PISCES'* manipulator and, with the torpedo clamped, the manipulator was jettisoned and later retrieved by hauling in the buoyed line from the surface. At times, the torpedo was buried beneath the sediment. In such instances a 5-hp, electric motor drove a pump attached to *PISCES'* manipulator which sucked up mud and deposited it several meters away. In this fashion the bottom was "dug out" until the torpedo was located. In 12 months 120 torpedoes were retrieved using these methods. In a similar manner the *PISCES*-class vehicle has been used to excavate the bottom for burial of cables. Lockheed developed a special device for large object recovery for *DEEP QUEST*, shown in Figure 11.20.

#### Submersible Retrieval (Ref. 43)

*ALVIN* was lost in 1968 when a cradle cable broke during launch and she descended 5,500 feet deep off Cape Cod. *ALVIN* was subse-

quently photographed and precisely located by a towed "fish" which showed it sitting upright on the bottom; a transponder and flashing light was installed very close to *ALVIN* which served as a reference point for *ALUMINAUT*. From *USNS MIZAR* a toggle bar was lowered at the end of 7,000 feet of 4½-inch-circumference nylon line; 500 feet from the toggle bar two 1,000-pound lead balls were attached and a Stimson anchor below these. A flashing light was attached 50 feet above the toggle and a few feet above was a transponder for *MIZAR* to interrogate. On its first dive *ALUMINAUT* was guided by *MIZAR* to *ALVIN* and found the hatch open. Attempts to place the toggle bar inside the hatch were futile until a second dive when *ALUMINAUT* inserted a new toggle bar into the hatch and attached its 25-foot-length of 6-inch line to the original lift line; *MIZAR* then lifted *ALVIN* to the surface.

#### Instrument Retrieval (Ref. 42)

To retrieve a 2,930-foot-long current meter array from the 3,150-foot depth off St. Croix,

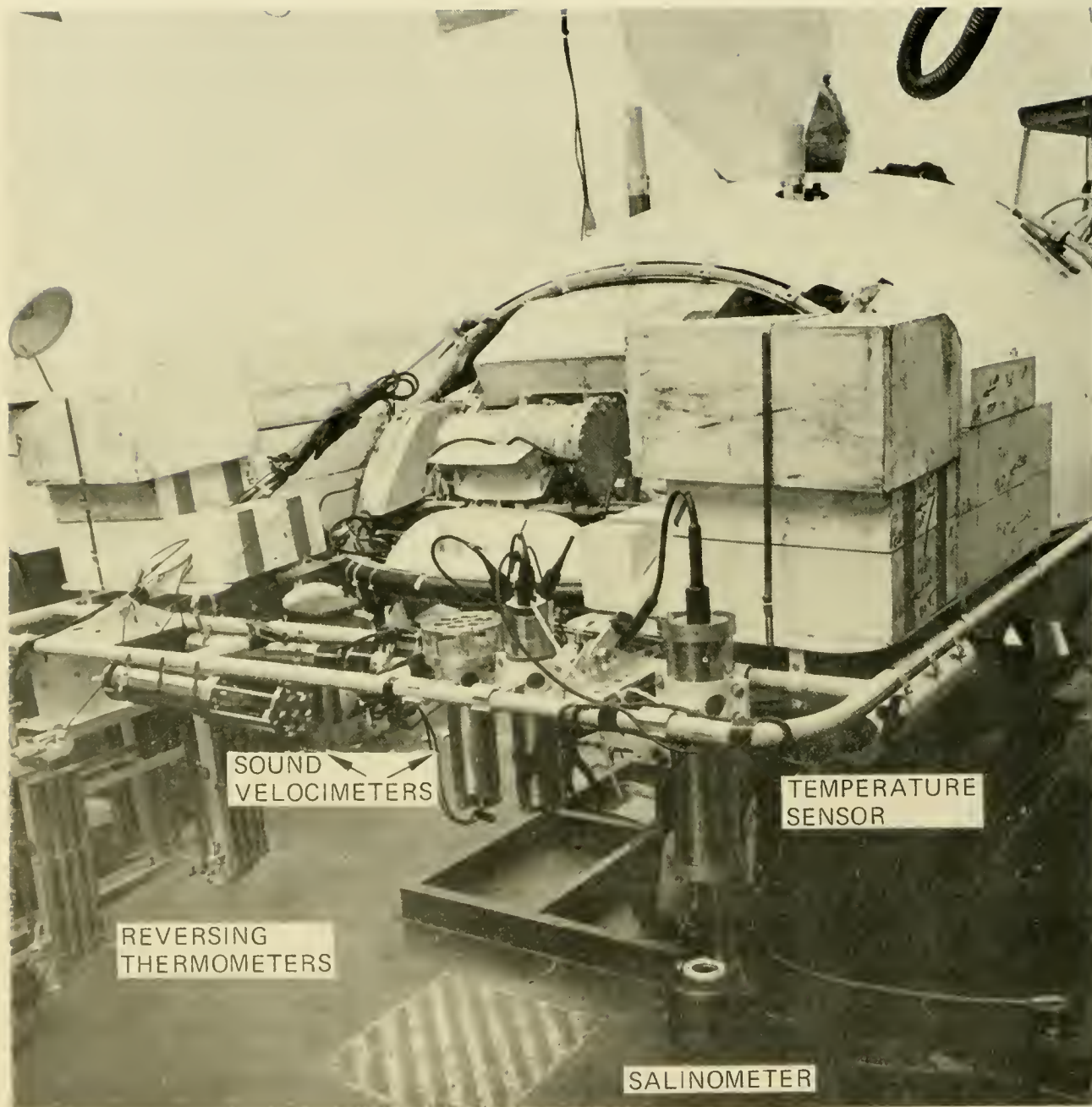

Fig 11 16 DEEPSTAR 4000 prior to a dive for the Naval Electronics Laboratory. The slightly negatively buoyant instrument brow is jettisonable and uses syntactic foam to provide buoyancy for the instruments. The water bottles (Fjarlie) are sealed, and filled, when desired, by spring-loaded caps actuated by solenoids. The current meter is placed on the bottom and an electric cable connects it to a Rustrak recorder within the hull. The plastic bag contains fluorescein dye, it is opened on the bottom by the manipulator and is used to observe water movements. Above the dye bag, but not visible, are 36-in-long probes which hold thermometers along their sides and are stuck into the bottom to measure water/sediment temperatures. (NUC)

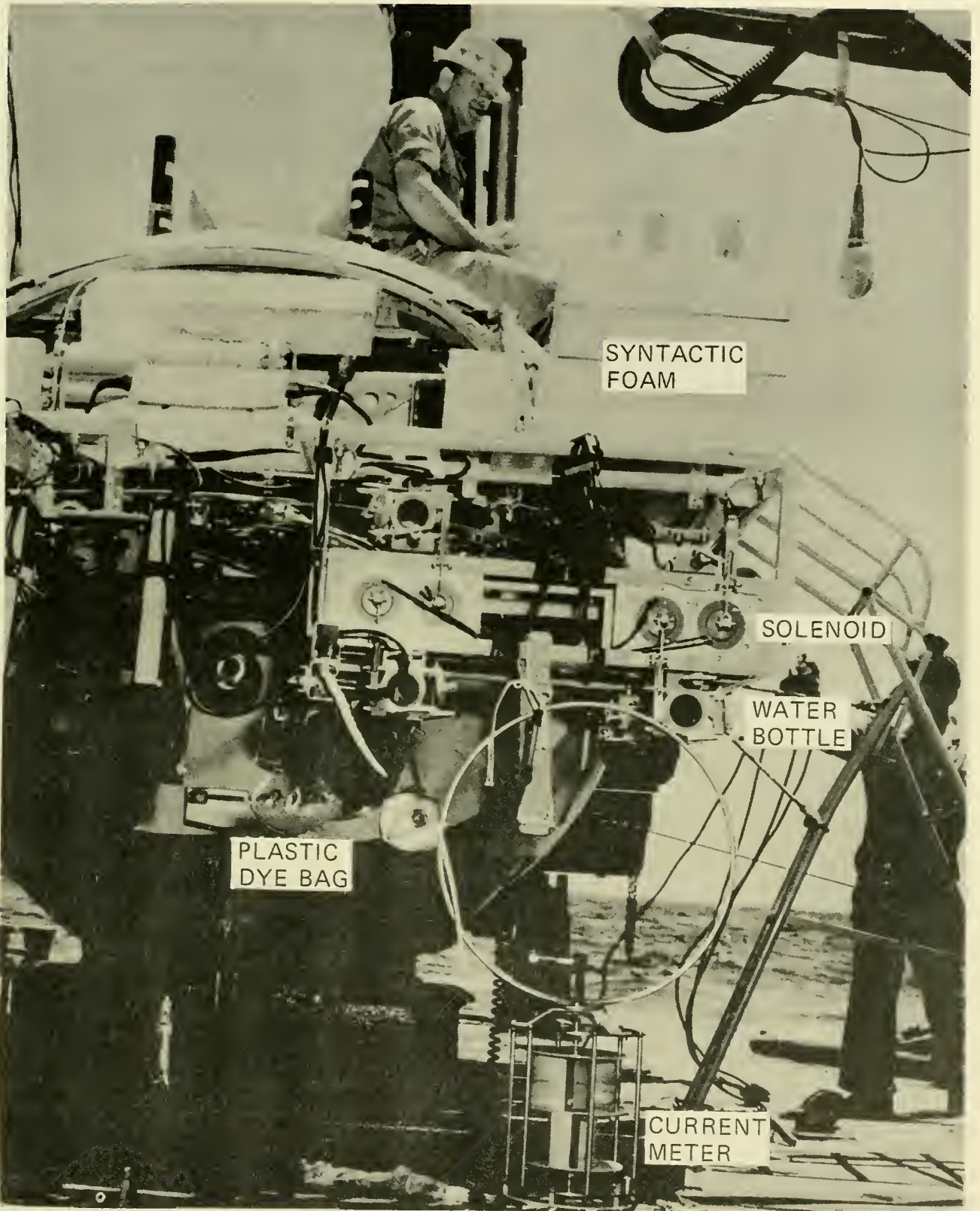

Fig 11.17 DEEPSTAR 4000 equipped with various instruments for an investigation of the water column. Behind the reversing thermometers are water sampling bottles. The details of this work are contained in ref. (50). (NUC)



a)

Fig. 11.18 a) A sediment strength measuring probe deployed by *ALUMINAUT* at 6,000 ft. The rings provide depth of penetration data and an accelerometer within a glass sphere inside the cylindrical housing provides supporting information. The glass sphere is retrieved by retracting the pin on the right which allows the sphere to surface. (NAVOCEANO)  
b) *STAR III*'s parabolic acoustic reflector transducer system was used to monitor reverberation of deep scattering layers. It also includes a stereo camera system. (Gen. Dyn.)  
c) A diver adjusts an apparatus on *ALUMINAUT* which was used in an experiment to measure sediment consolidation. When *ALUMINAUT*'s manipulator retracted one of the rings, a steel ball of known dimensions and density fell to the bottom, a camera photographed the sediment cloud produced and subsequently, the imbedded ball itself. (NAVOCEANO)  
d) A close-up of the reversing thermometer racks shown in Fig. 11.17 The solenoids (left) released the thermometer rack from its upright position when activated. (WHOI)

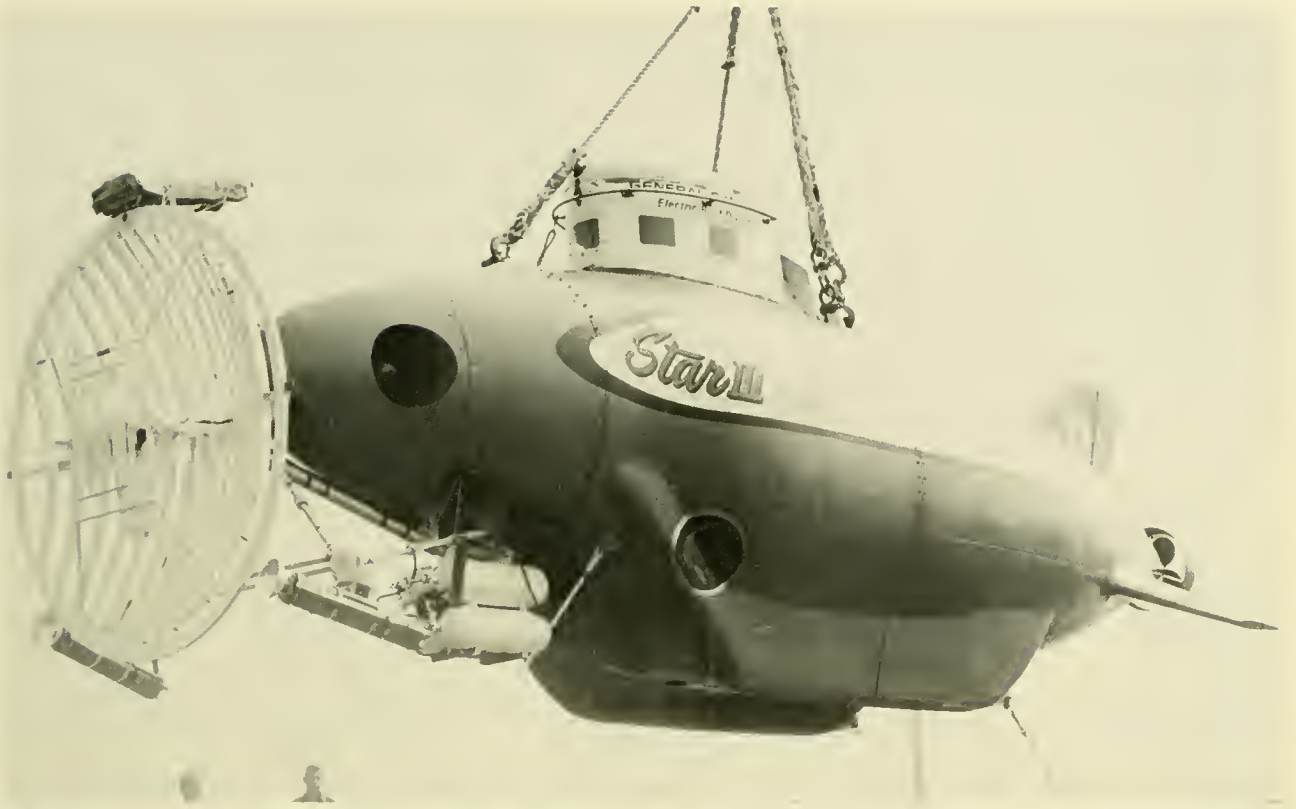

Fig. 11.18 b



Fig. 11.18 c

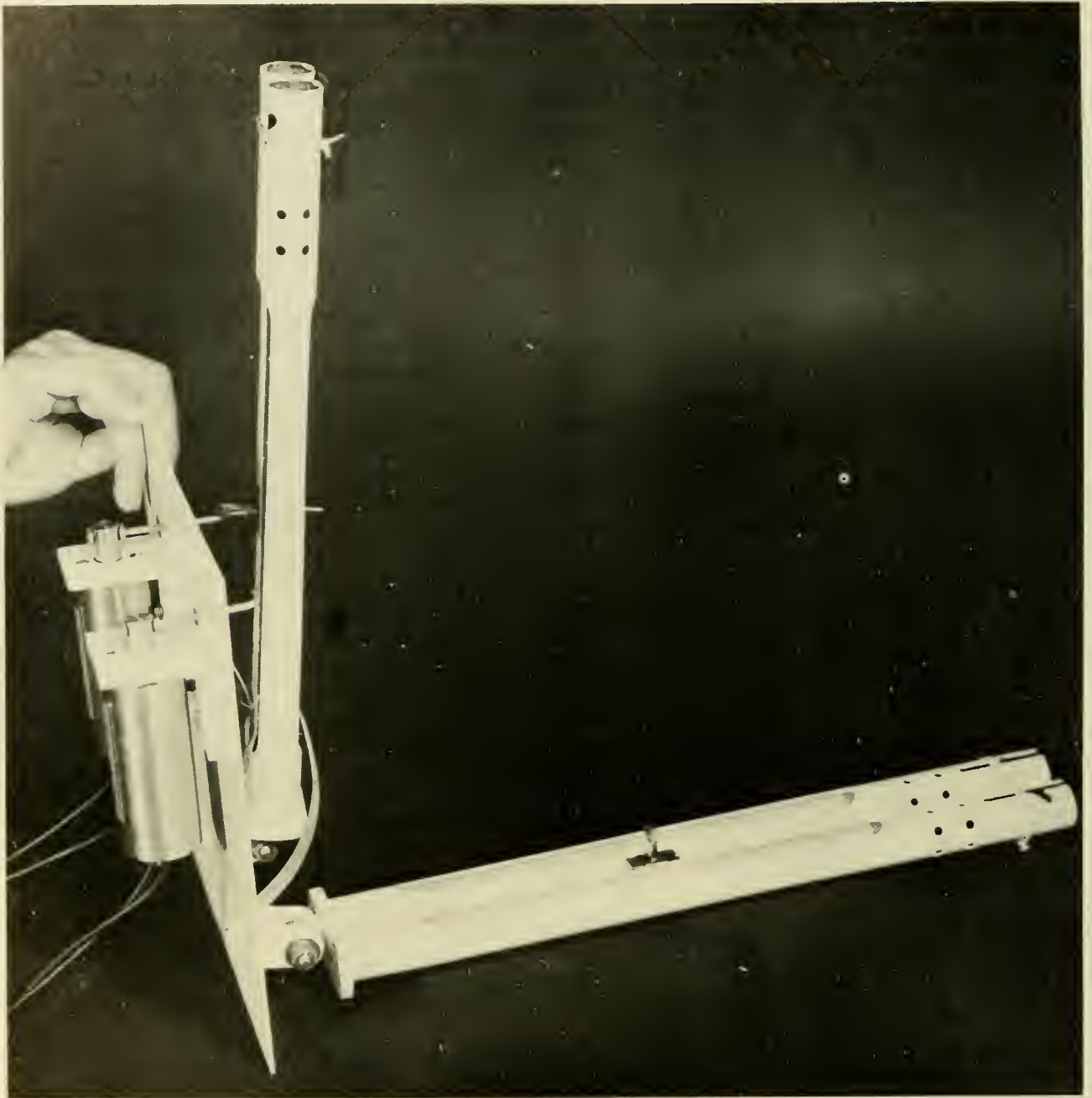
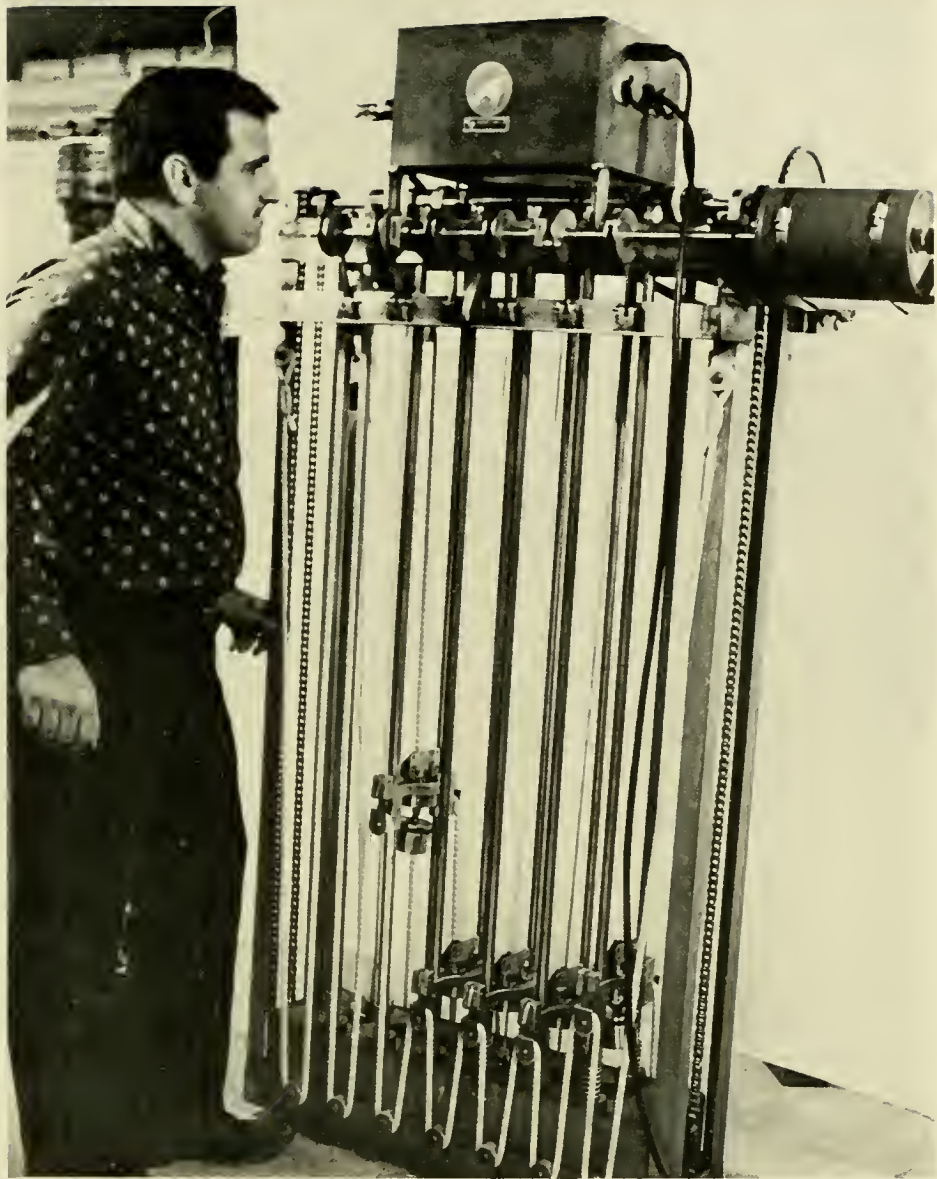

Fig. 11.18 d

Virgin Islands, *ALUMINAUT* carried 2,300 feet of  $\frac{1}{2}$ -inch nylon line coiled about a pipe protruding from one side of a wooden disc (Fig. 11.21). The array was visually located, and the bottom of the coiled line was attached to the array line with the manipulators. The beehive-shaped coil was then placed on the bottom and *ALUMINAUT*, to which the opposite end of the line was attached, surfaced and the line paid out. When

*ALUMINAUT* surfaced the load was transferred to a surface ship which subsequently hauled in the array with five current meters and one acoustic release mechanism. Grapneling for the lost array was impractical because of several telemetry cables which traversed the bottom in the same area. A similar approach was used by *DEEP QUEST* to recover a Navy fighter plane from 3,400 feet off San Diego in 1970.



a)

Fig. 11.19 a) The Benthos-manufactured sediment corer designed for *DEEP QUEST*. (Benthos Corp.)

b) Plastic water samplers developed by WHOI. The sampler is rotated by the manipulator to open the lead-weighted doors and then purged by moving it through the water. Further rotation closes the flap valve doors to collect a water sample. (WHOI)

c) An oil-filled compass attached to *DEEPSTAR 4000*'s manipulator provides directional information to augment observations of the bottom.

d) Manufactured by HYCO to cut a sunken tugboat's anchor chain, the hydraulic cutter attached to the manipulator of *PISCES I* is capable of exerting 60,000 pounds of pressure on its case-hardened steel blade. (HYCO)

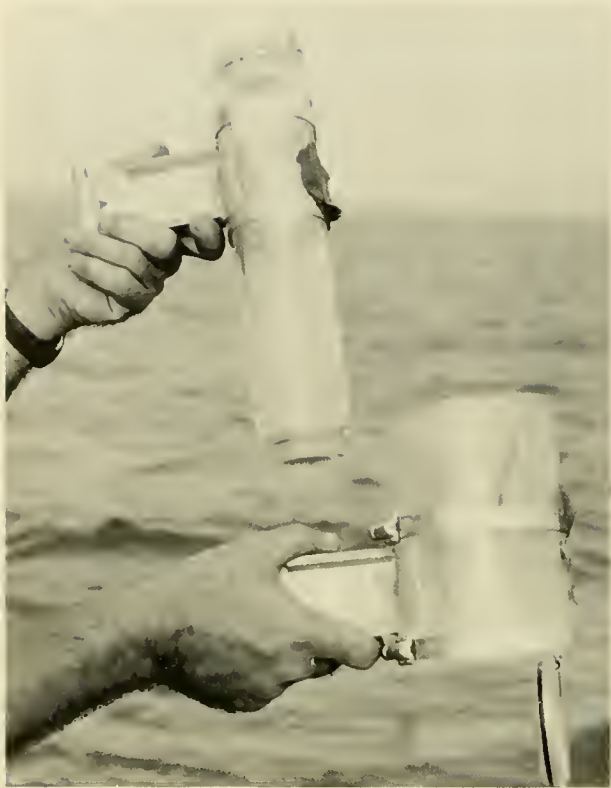

b)

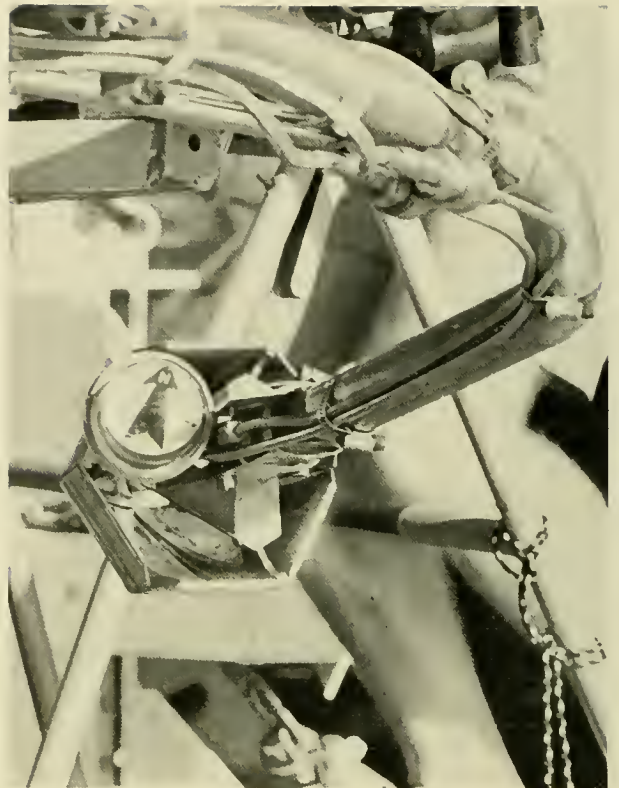

c)



d)



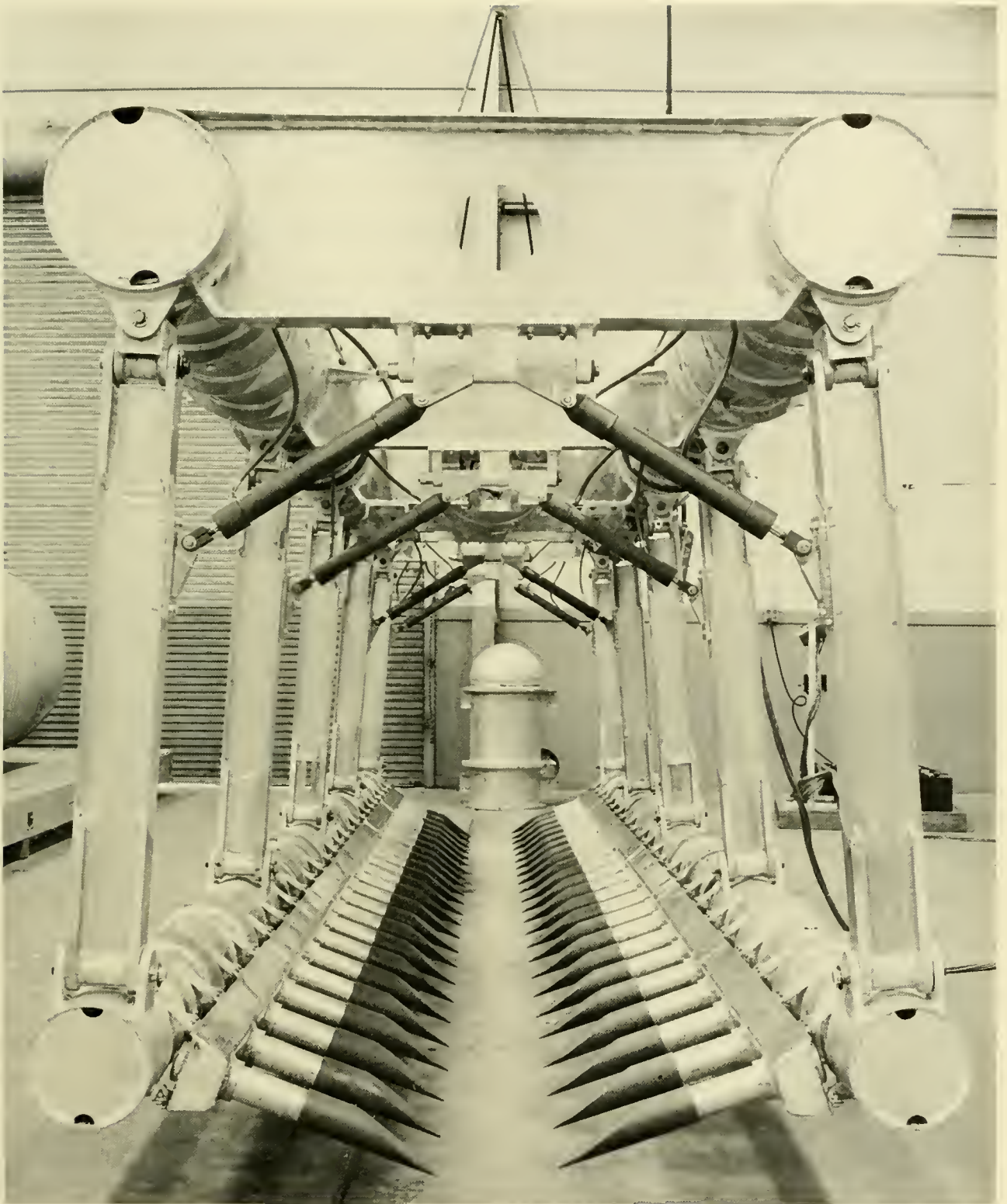
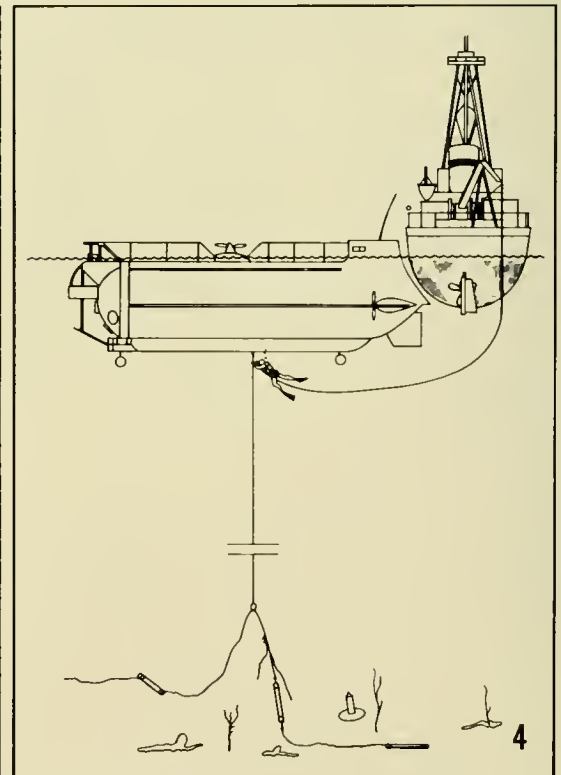
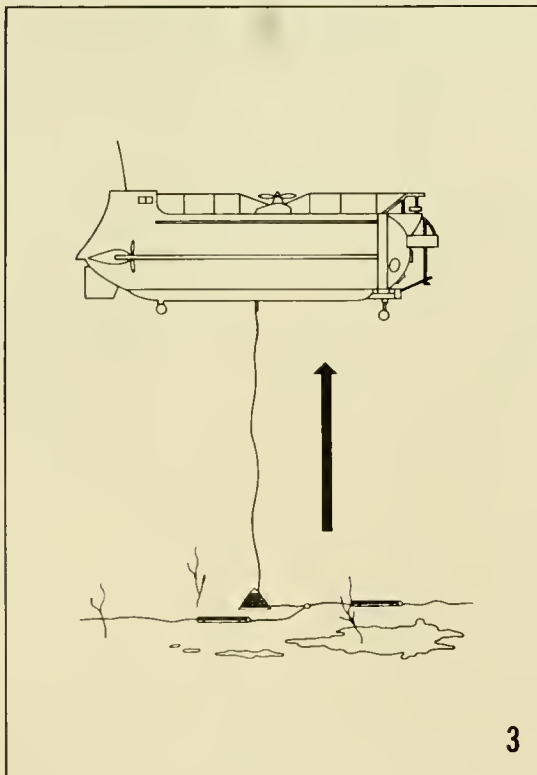
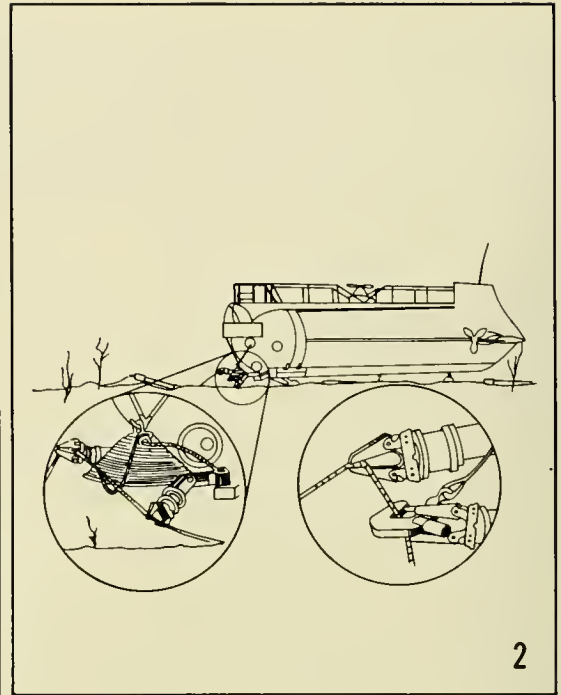
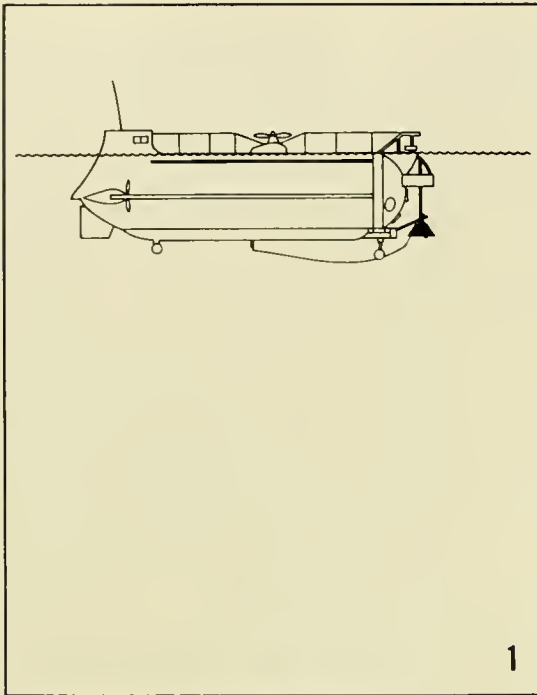

Fig. 11.20 Designed by Lockheed for *DEEP QUEST*, this device is attached to the vehicle's keel for retrieval of torpedo-size objects. (LMSC)



### INSTRUMENT PLANT AND RETRIEVAL

Fig 11 21 ALUMINAUT's current meter array retrieval technique. (NAVOCEANO)

## Submersible Rescue (Ref. 44)

The submersible **DEEP QUEST** became entangled in a  $\frac{3}{8}$ -inch polypropylene line attached to a 1,600-pound (wet weight) recovery device at a 430-foot depth off San Diego. Not wishing to jettison its expensive equipment to surface and with the boat at a precarious trim angle, Lockheed management called in **NEKTON** to cut the line. A diver's knife was tied to the smaller vehicle's 3-foot-long mechanical manipulator and it cut the line 13 hours after **DEEP QUEST** became entangled. In a similar but less urgent task, the bathyscaph **ARCHIMEDE** freed the unmanned **SP-3000** from a depth of 3,400 meters in 1971 in the Mediterranean (45). **SP-3000** was being lowered on a test dive. A weight was attached 17 meters below on a nylon cable to counteract the submersible's positive buoyancy. The lowering cable attachment to the vehicle unscrewed and **SP-3000** sank to the bottom where it remained "at anchor." No equipment was in existence that could operate at 3,400 meters to cut the cable. Three devices were immediately designed and manufactured: A double system of cleavers placed on the fender of **ARCHIMEDE**, two rotating shear devices and a mechanical shear with springs. All three systems were fitted on the bathyscaph for its dive. **SP-3000** had both an external pinger and transponder. **ARCHIMEDE** used the pinger to determine the azimuth of **SP-3000** and advanced to within 1,350 meters of it when its CTFM detected the transponder. The bathyscaph was maneuvered into a position where the rotating shear was used to cut the cable and allow **SP-3000** to surface. Interestingly, from a historical point of view, the first **SP-350** hull (then **DIVING SAUCER**) was lost 14 years earlier in an identical fashion (46).

## Hardware Inspection

A number of submersibles have been used to inspect cables, pipelines, offshore structures and a variety of other hardware. Such missions incorporate visual observations, TV video recorders and still and motion picture cameras. The types of instruments vary according to the submersible. In one mission **SHELF DIVER** followed a diver while he inspected a pipeline and supplied his breath-

ing gas mixture from a hose within its lock-out compartment (Fig. 11.22); in another instance, the same vehicle inspected 0.6 mile of the inside of a 15-foot-diameter pipe carrying fresh water beneath the French Alps.

## Artifact Mapping (Ref. 47)

The submersible **ASHERAH** was used by the University of Pennsylvania to map stereophotographically a 4th century Roman shipwreck in 130 feet of water off Bodrum, Turkey. The resultant photomosaic (Fig. 11.23) of the 20- × 40-foot area was used to produce a topographic chart with an accuracy of 1.5 inches in three dimensions.

To conduct this work the following instruments were used:

- 2— 70-mm cameras (Hydro Products PC-750)
- 2— 20-W/sec strobe lights



Fig. 11.22 **SHELF DIVER** behind the diver (Perry Sub. Builders)

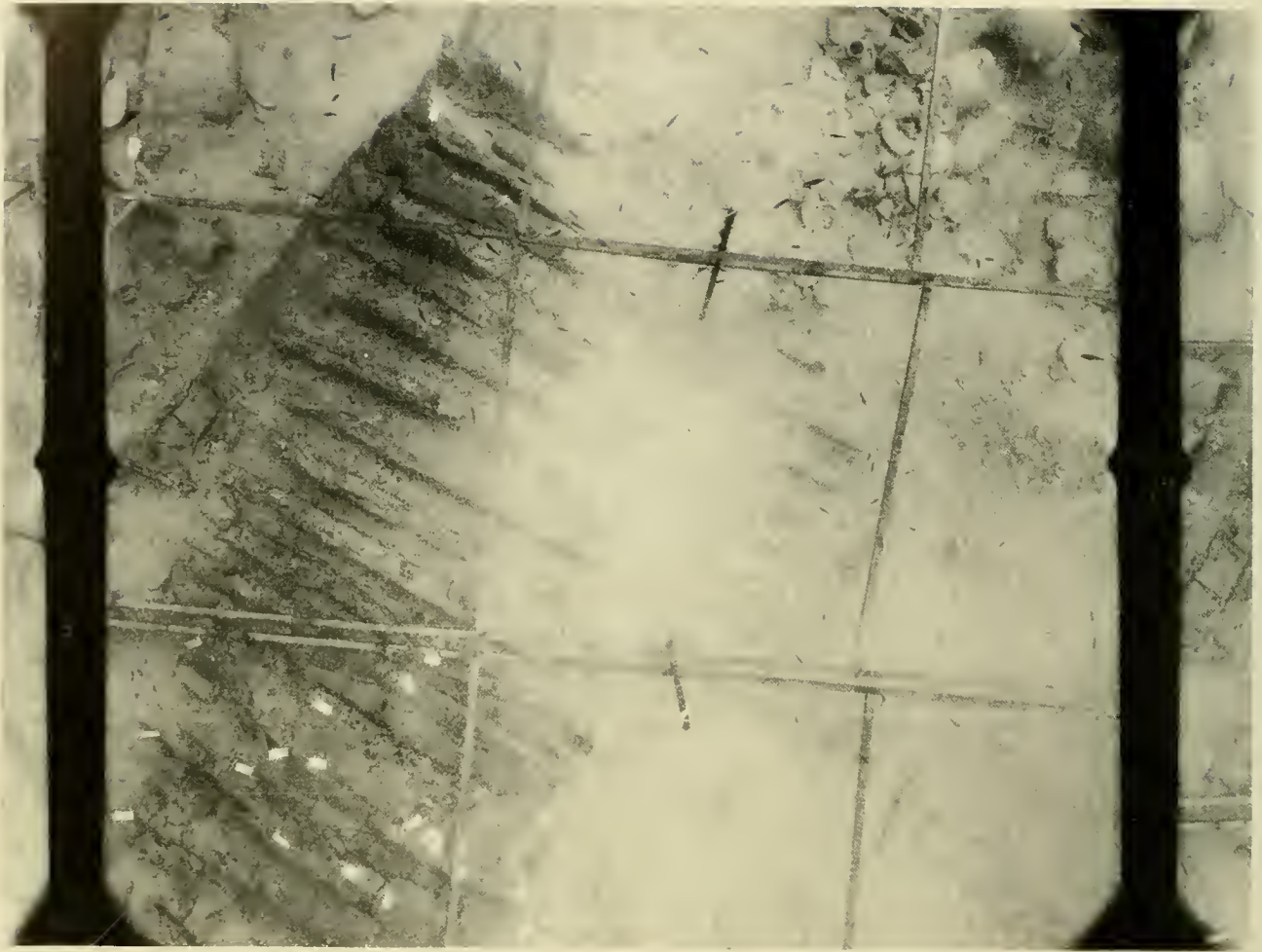

Fig. 11.23 Photomosaic of a 4th century Roman shipwreck taken by ASHERAH. (Univ. Penna.)

- 1— Television camera (Hydro Products TC0303) mounted between the 20-mm cameras
- 1— TV monitor (Sony PVT 304R U) in pressure hull
- 1— Tilt sensor (General Precision C70 9560) to obtain vehicle's pitch and roll with each camera exposure
- 1— Isobaric altimeter (differential pressure gage) to define a horizontal plane parallel to mean sea level and assist the pilot in maintaining constant above-the-bottom altitude
- 1— Bendix Fathometer (200-kHz) to indicate distance-to-bottom
- 1— Magnesyn compass to provide azimuth direction

- 1— Photographic recorder (Nikon F) to obtain a permanent record of tilt, altimeter reading and camera frame number.

The cameras were adjusted to expose at a preselected interval in concert with the strobes. Proceeding at a predetermined compass course the pilot attempted to maintain a distance of 15 to 20 feet off the bottom using the Fathometer and the altimeter for guidance. With each exposure of the 70-mm camera there was a synoptic exposure of the 35-mm camera to record the vehicle's attitude for subsequent photographic analysis. Similar results were obtained by Pollio (9) using *STAR III* and 35-mm cameras. The choice of 35-mm versus 70-mm format is influenced by trade-offs. A 70-mm film provides

better resolution, but the present number of exposures attainable (400) is far less than that of the EG&G 35-mm (3,300).

### Ship Salvage (Ref. 48)

In concept, the salvage of a 95-ton, 51-foot tug (Fig. 11.24) in Howe Strait, B.C. from 670 feet was similar to *ALUMINAUT*'s recovery: Lift lines were lowered from the surface instead of reeled up from the bottom. The difference lies in the tools required for the tug salvage by *PISCES I*. After anchoring a lifting barge with a four-point moor over the sunken tug, a plan was devised whereby *PISCES I* would cut two anchor chains on

the tug's bow at the windlass to allow insertion of a toggle bar into each of the hawse pipes after the anchor chains slid clear. A sling would then be passed from the bow to the stern of the ship providing fore and aft lines for the required horizontal lift. Whereas no hydraulic chain cutter existed, a blade cutter of 60,000-pound force was made by the owners of *PISCES* in 5 days to cut the  $\frac{5}{8}$ -inch-thick chain. After much difficulty both anchors were removed and one toggle inserted; the second toggle, however, jammed in the hawse pipe. A 65-pound weight was bolted to the manipulator to provide the submersible with a hammering ca-



Fig. 11.24 The 95-ton *EMERALD STRAITS*. Retrieved from 670-foot depth in 1969 with lines attached by International Hydrodynamic's *PISCES I*. (HYCO)

pability. Because *PISCES* had to be maneuvered back into position after each blow, 10 hours of pounding were consumed before the toggle was successfully driven home. Previous to the toggle insertion, the submersible assisted in maneuvering the wire rope sling from bow to stern. Prior to lifting, *PISCES* made a final inspection of the tug and lift lines to assure that all components were secure.

### Dumping Ground Inspection (Ref. 49)

Increased environmental awareness has prompted a number of recent diving operations which are of both an engineering and a research nature. *DEEP QUEST* dived off the coast of Southern California in 1972 to determine the possible harm and other results of dumping contaminated industrial and radioactive wastes, garbage and trash in water depths of 6,000 feet. Visual observations and photographic/TV coverage were used to assess and document the condition of the containers and the obvious effects on the environment. A salinity/temperature/depth system and light transmissometer were used to measure *in situ* conditions. A core sampler and multi-rosette water sampler (General Oceans Inc.) were used to collect samples for subsequent laboratory analyses.

The instruments described above are largely for scientific investigations, but present submersible work is in the engineering, *e.g.*, hardware inspection, repair, implantment, area. Unfortunately, there is a scarcity of publications dealing with the tools of this trade, possibly because some are proprietary and some may not perform as well as anticipated. Whatever the reason, the absence of such accounts is detrimental to the field at large, because it leaves each user to his own devices to try, through trial and error, to derive working, practical instruments. As a result, when progress is on such an individual basis it can be painfully slow.

### REFERENCES

- Ballard, R. D. & Emery, K. O. 1970 *Research Submersibles in Oceanography*. Mar. Tech. Soc. Pub., Wash., D.C., 70 pp.
- Hull, E. W. S. 1967 *Those remarkable little work boats*. Geo. Mar. Tech., v. 3, n. 5, p. 22-40.
- Haigh, K. R. 1970 *Instrumentation Interference in submersibles*. Mar. Tech. Soc. 6th Ann. Sym., v. 2, p. 1189-1201.
- Hawkins, L. K. & Merrifield, R. 1970 *Instrumentation on manned submersibles*. U.S. Naval Oceanographic Office, I.R. No. 70-8, 28 pp.
- Rainnie, W. O., Jr. 1968 *Adventures of ALVIN*. Ocn. Ind., v. 3, n. 5, p. 22-28.
- Winget, C. L. 1969 *Hand Tools and Mechanical Accessories for a Deep Submersible*. W.H.O.I. Tech. Rept. Ref. 69-32, 445 pp.
- Busby, R. F. 1970 *Oceanographic Instrumentation on the submersible BEN FRANKLIN*. Trans. Mar. Tech. Soc. 6th Ann. Conf. & Expo., v. 2, p. 1041-1078.
- U.S. Naval Oceanographic Office 1970 *Manned Submersibles and Underwater Surveying*. Special Rept. 153, 156 pp.
- Pollio, J. 1969a *Applications of underwater photogrammetry*. Mar. Tech. Soc. Jour., v. 3, n. 1, p. 55-72.
- Benthos, Inc., Falmouth, Mass. *Submarine Piston Corer Benthos Type 343..*
- Thomson, M. F. & McFarlane, J. R. 1972 *Submersible development in Canada*. 2nd Int. Ocn. Dev. Conf., Japan, v. 1, p. 799-809.
- Higgs, R. H. & Carroll, J. C. 1967 *ALUMINAUT magnetometer operation, St. Croix, Virgin Islands 1966*. U.S. Naval Oceanographic Office, I.R. No. 67-33, 28 pp.
- U.S. Naval Undersea Center 1968 *DEEP STAR logs (1 through 4)*; U.S. Naval Undersea Center, San Diego, Calif., 202 pp. (Unpub. Manuscript)
- Busby, R. F. & Merrifield, R. 1967 *Undersea studies with the DSRV ALVIN, Tongue of the Ocean, Bahamas*. U.S. Naval Oceanographic Office, Informal Rept. No. 67-51, p. 54.
- Thompson, L. D. 1968 *Gravity meter tests on the Deep Research Vehicle ALUMINAUT, Vieques, Puerto Rico*. Final Rept. of U.S. Naval Oceanographic Office, Cont. No. N62306-68-60008. Items 2 & 4.
- Church, R. 1969 *Abyssal photography from DEEPSTAR-4000*. Jour. Mar. Tech. Soc., v. 3, n. 1, p. 95-100.
- Society of Photo-Optical Instrumentation

- Engineers, 1968 S.P.I.E. Seminar Proceedings, *Underwater Photo-optical Instrumentation Applications*, v. 12, Feb. 1968.
18. Woods Hole Oceanographic Institution 1967 *Deep Submergence Research Conducted During the Period 1 January through 31 December 1966*. W.H.O.I. Ref. No. 67-23, 23 pp.
  19. Breaker, L. C. & Winokur, R. S. 1967 *The variability of bottom reflected signals using the deep research vehicle ALVIN*. U.S. Naval Oceanographic Office, I.R. No. 67-92, 19 pp.
  20. Milliman, J. D., Manheim, F. T., Pratt, R. M. & Zarudski, E. F. K. 1967 *ALVIN Dives on the Continental Margin off the Southeastern United States*. W.H.O.I. Ref. 67-80, 48 pp.
  21. Inderbitzen, A. L., Simpson, F. & Goss, G. 1970 *A Comparison of In-Situ and Laboratory Vane Shear Measurements*. Lockheed Missiles and Space Company Report 681703, 35 pp. (Unpub. Manuscript)
  22. Perlow, M., Jr. & Richards, A. F. 1972 *In-Place geotechnical measurements from submersible ALVIN in Gulf of Maine soils*. Reprint from 4th Ann. Offshore Technology Conf. Houston, Tex., May 1972, Paper No. OTC 1543.
  23. Sly, P. G. 1971 *Submersible Operations in Georgian Bay and Lake Erie—1970*. Canadian Dept. of Energy, Mines and Resources Tech. Bull. No. 44, 36 pp.
  24. Hirst, T. J. 1973 *Vertical variability of sediment shear strength*. Mar. Tech. Soc. Jour., v. 7, n. 1, p. 21-24.
  25. Hamilton, E. L., Bucker, H. P., Keir, D. L. & Whitney, J. A. 1969 *In-Situ determinations of the velocities of compressional and shear waves in marine sediments from a research submersible*. Naval Undersea Research and Development Center, San Diego, Calif., TP 163, 26 pp.
  26. MacKenzie, K. V. 1968 *Accurate depth determinations during DEEPSTAR-4000 dives*. Jour. Ocn. Tech., v. 2, n. 2, p. 61-67.
  27. Merrifield, R. 1969 *Undersea Studies with DEEPSTAR-4000*. Oct.-Nov. 1967, I.R. No. 69-15.
  28. Maxwell, A. E., Lewis, R., Lomask, M., Frassetto, R. & Rechnitzer, A. 1957 *A preliminary report on the 1957 investigations with the bathyscaph, TRIESTE* (Unpub. Manuscript)
  29. Rechnitzer, A. B. 1962 *Summary of the bathyscaph TRIESTE research program results (1958-1960)*. Naval Engineering Laboratory Report 1095, San Diego, Calif., 63 pp.
  30. LaFond, E. C. 1962 *Deep current measurements with the bathyscaph TRIESTE*. Deep-Sea Res., v. 9, p. 115-116.
  31. MacKenzie, K. V. 1961 *Sound-speed measurements utilizing the bathyscaph TRIESTE*. Jour. Acous. Soc. Amer., v. 33, n. 8, p. 1113-1119.
  32. Jerlov, N. G. & J. Piccard 1959 *Bathyscaph measurements of daylight penetration into the Mediterranean*. Deep-Sea Res., v. 5, p. 201-204.
  33. Bennett, R. H., Keller, G. H. & Busby, R. F. 1970 *Mass property variability in three closely spaced deep-sea sediment cores*. Jour. Sed. Petrol., v. 40, n. 3, p. 1038-1043.
  34. Buffington, E. C., Hamilton, E. L. & D. G. Moore, 1967 *Direct measurement of bottom slope, sediment sound velocity and attenuation, and sediment shear strength from DEEPSTAR-4000*. In. Proc. 4th U.S. Navy Symp. on Military Oceanog., v. I, p. 81-90.
  35. Pelletier, B. R. 1968 *The submersible PISCES feasibility study in the Canadian Arctic*. Maritime Sediments, v. 4, n. 2, p. 69-72.
  36. Noakes, J. E. & Harding, J. L. 1971 *New techniques in seafloor mineral exploration*. Jour. Mar. Tech. Soc. v. 5, n. 6, p. 41-44.
  37. Assard, G. L. & Hassell, B. C. 1966 *Measurements of the spatial correlation of ambient noise using a deep-submergence vehicle. (DIVING SAUCER-SP-300)*. U.S. Navy Underwater Sound Laboratory Rept. No. 714, 19 pp.
  38. Caddy, J. F. 1969 *Underwater observation techniques in fisheries research*. in, *MAN IN COLD WATER*, Conf. on Undersea Operations in the Canadian Environment, McGill Univ., Montreal, May 12-13 1969, p. 33-34.
  39. Barham, E. G., Ayer, J. J., Jr. & Boyce, R. E., 1967 *Macrobenthos of the San Diego Trough: photographic census and obser-*

- vations from bathyscaph, TRIESTE.* Deep-Sea Res., v. 14, p. 773-784.
40. U.S. Navy Underwater Sound Laboratory 1966 *Acoustic research studies with deep submergence vehicles.* U.S. Navy Underwater Sound Lab. Tech. Memo. No. 2211-06-66, (Unpub. Manuscript)
  41. Personal communication with R. F. Bradley, Arctic Marine Ltd., Vancouver, B.C.
  42. Busby, R. F. 1967 *ALUMINAUT retrieves Current Meter Array.* Geo. Mar. Tech., v. 3, n. 5, p. 41-44.
  43. Rainnie, W. O., Jr., & Buchanan, C. L. 1969 *Recovery of the DSRV ALVIN,* Ocn. Ind., v. 4, n. 11, p. 62-64.
  44. Vernon, J. W. & Furse, L. D. 1972 *Working small submersibles.* Oceanology International Offshore Technology reprint, April, 1972.
  45. La Prairie, Y. 1972 *Recent achievements of the French in offshore technology.* Ocn. Ind., v. 7, n. 4, p. 115-120.
  46. Cousteau, J. Y. & Dugan, J. 1963 *The Living Sea.* Harper and Row Publishers, New York and Evanston.
  47. Bass, G. F. & Rosencrantz, D. M. 1968 *A Diversified Program for the Study of Shallow Water Searching and Mapping Techniques.* Final Report under Office of Naval Research Cont. N00014-67A-0216-0002, The Univ. Museum, Univ. Penna., Phila., Pa., 130 pp.
  48. Ocean Industry 1972 v. 7, n. 8, p. 51.
  49. Niblock, R. W. 1969 *Submersible key to salvaging tug from 670-ft. depth.* Undersea Tech., p. 40-42.
  50. Mackenzie, K. V. 1970 *Oceanographic data acquisition system for undersea vehicles.* Preprints, 6th Ann. Conf. & Expo., Mar. Tech. Soc. Conf., 29 June-1 July 1970, Wash., D.C., v. 2, p. 1078-1098.





# 12

## SEA AND SHORE SUPPORT

The procedures and support required to place a submersible on the surface and "ready to dive" are extensive. To conduct open-sea diving operations one must have a means of transportation, a launch/retrieval system, specialized technicians and shop facilities for overhaul, maintenance and repair. The annual cost to maintain an operationally-ready submersible can begin at \$80,000 (*SEA OTTER*), which does not include a support ship or launch/retrieval system. Larger, deeper-diving vehicles, such as *ALVIN*, may require up to \$800,000 or more annually, which does include a support ship or launch/retrieval system. No figures are available for annual support costs of a bathyscaph, but it

undoubtedly far exceeds \$1 million in the case of *TRIESTE II*.

### TRANSPORTATION

Before confronting the sea-going problems, the submersible operator first must transport his vehicle to a point where it can be either placed aboard ship or launched for towing. In some instances, such as the California-based *NEKTON*, a cross-country trailer tow brought it to Lake Michigan; *SEA OTTER* was transported from one dive site to another by a helicopter; in another case, *ALVIN* made a trans-Atlantic flight from Cape Cod to Spain; while *ALUMINAUT*, too

large for an aircraft, reached the same destination from Miami, Florida aboard an *LSD*. *AUGUSTE PICCARD*'s trip aboard a flatbed trailer from Lausanne, Switzerland to Marseilles, France involved intricate scheduling and the cooperation and participation of police and local civil officials as the 93-foot submersible carefully wound its way through the ancient, narrow streets of southern France. Obviously, the larger the submersible, the larger the problem, and time is of the essence, because the user of the submersible pays for mobilization as well as diving costs.

### Land

Transportation of a submersible by land is not too different from transporting any object of comparable size and weight. Load and dimension regulations apply the same as they do with conventional cargo, whether it be by trailer, flatbed van or rail. One unique aspect, however, resides with some vehicles'

more delicate instruments, which vibration may damage or, at the least, loosen nuts and bolts. Tests performed by the Association of American Railroads and a summary of accumulated data relative to loading conditions that exist in a variety of transportation conditions indicate the greatest loading factor to be 2.25 g vertical. When *ALVIN* was shipped by flatbed trailer (Fig. 12.1) from Minneapolis, Minn. to Cape Cod, Mass., shock-measuring instruments were attached and found the loads to be less than those shocks (1.2 g) encountered during routine launch/retrieval aboard *LULU*. Regardless of the method or rigors of transport, it is a practice of the *ALVIN* group and others to recheck and tighten all nuts and bolts prior to diving. When load and dimensions allow, trucks or trailers incorporating air-ride suspension systems are used. Obviously, in the case of large submersibles, such as *BEN FRANKLIN*, a route must be selected which will avoid bridges under which the vehicle cannot physically pass.

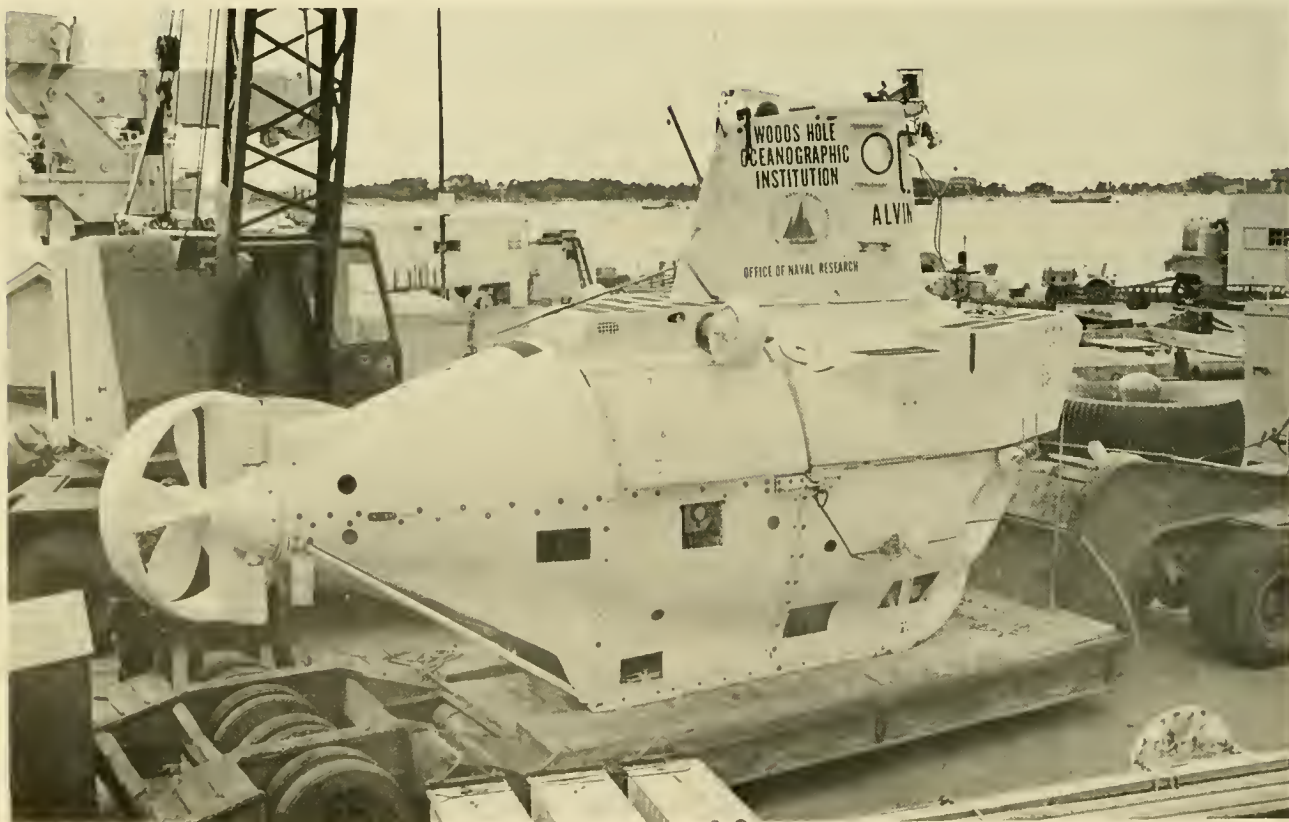

Fig. 12.1 *ALVIN* ready to take to the road. (WHO)



Fig 12.2 DSRV-1 entering a C-141A with mating skirt removed (U.S. NAVY)

In spite of careful planning and handling, it is not uncommon to sustain damage which can cause several days' delay in diving operation. P. C. Sly (1) related that during air and road transit from Vancouver, B.C. to Trenton Air Base on the Bruce Peninsula, and thence to Tobermory on the Georgian Bay, *PISCES III* sustained damage to its drop weight mechanism, ballast bags and mechanical arms; three days were required to repair these and other damages incurred during the transport phase alone.

### Air

Submersible transport by air is accompanied by similar load and dimension constraints as found with land transport. Those submersibles not air transportable by reasons of weight, dimensions or both include

*ALUMINAUT, BEN FRANKLIN, AUGUSTE PICCARD, TRIESTE II, ARCHIMEDE* and *NR-1*. Lockheed's C-141A is presently the largest cargo carrying aircraft in the U.S.; its cargo entrance just accommodates the 8-foot 2-inch-diameter *DSRV* with its mating skirt detached (Fig. 12.2). Even so the 37-ton submersible must be specially loaded for the C-141A to accommodate the 1<sup>3</sup>/<sub>4</sub>-ton excess over its normal load capacity. There is no civilian aircraft of comparable weight dimensions to the C-141A. When the C-5A is operational its 95-ton capacity will accommodate all submersibles, with the possible exception of the bathyscaphs and *NR-1*. To gain some idea of the size of the C-5A, it presently requires three C-141A's to carry the *DSRV* and its support equipment, whereas only one C-5A can do the whole job.

The critical difference between land and air transport of submersibles lies in the possibility of pressure loss within the aircraft cabin; a loss of this nature may cause battery gassing, expansion of entrapped air in hydraulic systems or, at the extreme, popping of viewports. In some instances, such as leaking of battery acid, the failure may be detrimental to the safety of the aircraft as well as to the integrity of the submersible. A study performed on the *DSRV* identified the potential critical components on the vehicle with respect to aircraft cabin pressure loss. Because of the *DSRV's* sophistication, it is believed this list (Table 12.1) encompasses all components found on any submersible which might constitute an air shipping hazard.

### Sea

Transportation of a submersible as cargo aboard ship is relatively simple and primarily involves tying it down securely and assuring that a capability to lift it exists at both the port of embarkation and debarkation. This latter consideration can be a problem with the large (over 25-ton) submersibles. The 142-ton *BEN FRANKLIN* required two 100-ton-capacity cranes (Fig. 12.3) to handle

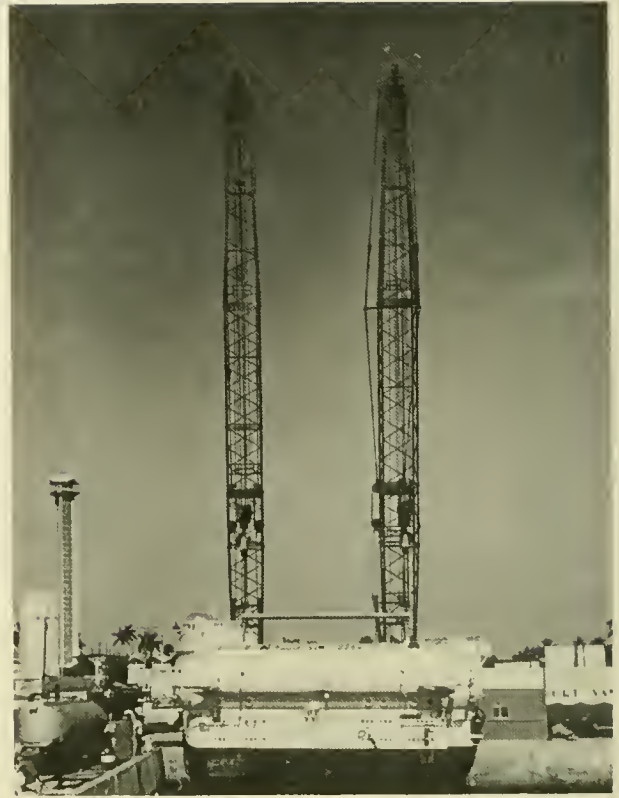

Fig. 12.3 The 142-ton *BEN FRANKLIN* requires two 100-ton (each) capacity cranes to lift it out of the water. (NAVOCEANO)

**TABLE 12.1 AIRCRAFT-HAZARDOUS DSRV COMPONENTS AND MATERIALS**

Item	Failure Mode	Failure Effect
Oxygen Bottles Nitrogen Bottles Air Bottles	Explosion/rupture/leak	Fragments and release of O <sub>2</sub> , N <sub>2</sub> , or air.
Mercury	Dump valves open inadvertently	Contamination of aircraft; release of toxic fumes and chemical reaction with metals.
Refrigeration Unit (contains Freon)	Rupture/leak	Under combustion heat would release toxic gas (phosgene).
Explosive cutters	Inadvertent detonation	Units jettisoned (pan & tilt, manipulators, etc.) fall free; not considered a hazard.
Hydraulic fluid	Rupture of hydraulic line or power unit	Spillage of fluid. Fire hazard.
Batteries: Ag-zn Lead-acid	Rupture of battery case and box. Outgassing due to temperature rise above 100 <sup>0</sup> F (becomes severe at 140 <sup>0</sup> F)	Electrolyte causes corrosion and skin burns. Silicon oil is flammable (flash point 330 <sup>0</sup> F) Release of Hydrogen gas.
Fire Extinguishers	Rupture/Leak	Release of Carbon Dioxide.

it at dockside. Such capabilities are not in the inventory of every port facility. It is also interesting to note that in 1969 each round trip *BEN FRANKLIN* made in and out of the water cost \$5,000. Compare this effort with the handling of *STAR I* in Figure 12.4.

Because a submersible contains various materials and components, *e.g.*, batteries, compressed air—which may be hazardous under certain conditions, one should consult Department of Transportation regulations governing such items. The following regulations govern such shipments:

Land: Code of Federal Regulations 49,

Water: Code of Federal Regulations 46,

Air: Code of Federal Regulations 14.

In the case of military air shipments, there is a special document entitled "Packaging and Handling of Dangerous Materials for Transportation by Military Aircraft." For the Navy this is NAVSUP PUB 505; for the

Air Force, AFN 71-4. The procedures outlined can be adopted for shipment by commercial air freight, but the list of hazardous materials which may be commercially shipped is more restrictive.

## SUPPORT PLATFORMS

The integral part the support platform plays in submersible operations is seen by reviewing the functions it performs for the submersible. These are:

1. Transport (aboard or tow) to dive site,
2. Launch/retrieve at dive site,
3. Accommodate support personnel and diving party,
4. Carry maintenance and repair equipment and provide sheltered work areas,
5. Communicate with, track, and direct the submersible during submergence,



Fig 12.4 The 1 $\frac{1}{4}$ -ton *STAR I* presents fewer handling problems than its large counterparts. (Gen. Dyn. Corp.)

6. Monitor weather and clear traffic for surfacing,
7. Provide means of transport to and from the submersible,
8. Carry scientific/engineering instrumentation and provide storage area for samples and work area for data reduction,
9. Conduct supplementary studies or functions in concert with the submersible before, during or after the dive,
10. Provide a safe haven in the event of emergency,
11. Fix submersible position in the event of rescue.

These functions reveal the reason for the term "submersible system," for without the support ship and launch/retrieval device, there is little a submersible can accomplish practically, economically or safely. Hirano (2) wrote the only published discussion of support ship requirements and commented on the fact that little mention has been made of support ships, in spite of their being so integral to successful submersible operations.

Support platforms display a variety of shapes and characteristics. The majority are conventional surface ships, but catamarans, barges, offshore fixed platforms and fleet-type submarines have been used. A representative sampling of these craft is shown in Figures 12.5 through 12.8.

In very few instances have owners or operators of a submersible built support platforms specifically for their submersibles. Generally, submersibles were built first and support was obtained during or after construction. The only exceptions are *DEEP QUEST's R/V TRANSQUEST*; *DEEPSTAR 2000's R/V SEARCHSTAR* and the *DSRV's ASR-21* class all being designed to support the specific vehicle. In a great number of cases the builder already had an active interest in the ocean and owned a platform which he equipped with a launch/retrieval apparatus suitable for both the platform and the submersible, e.g., Perry's *SEA HUNTER* and *SEA DIVER*, Cousteau's *CALYPSO*, General Motor's *SWAN*. A number of support platforms were obtained on lease by the sub-

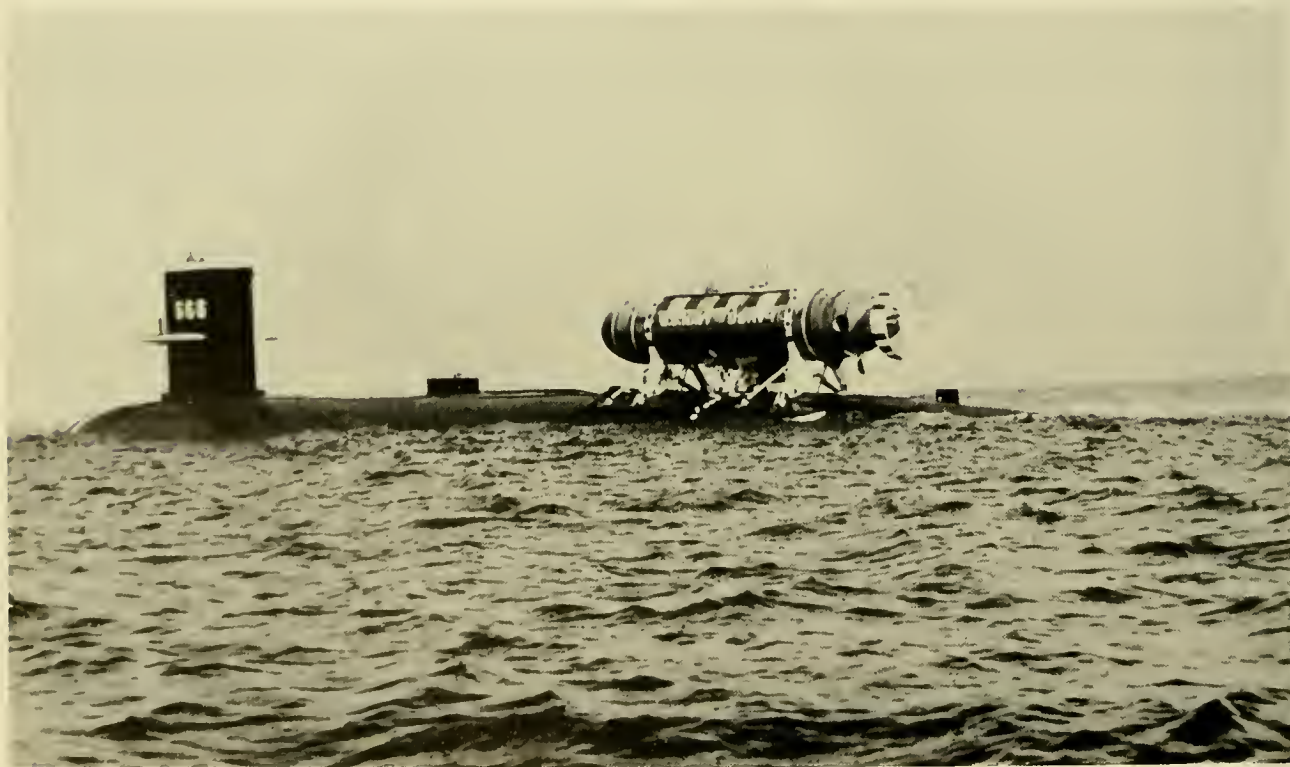

USS HAWKBILL (SSN 666)

Fig. 12.5 Submersibles' support craft.

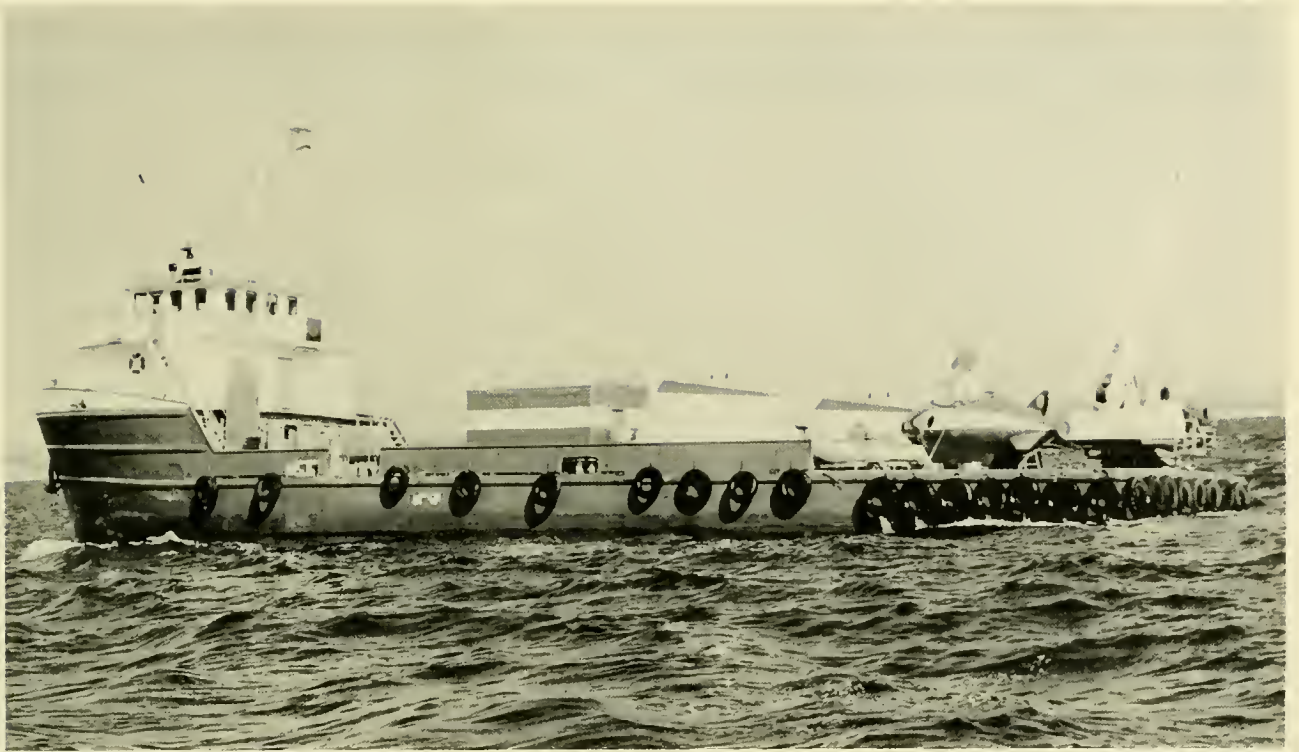

M/V GEMINI



R/V CALYPSO



M/V DAWNSTAR



M/V MAXINE D

Fig 12.6 Submersibles' support craft.





M/V SEARCH TIDE

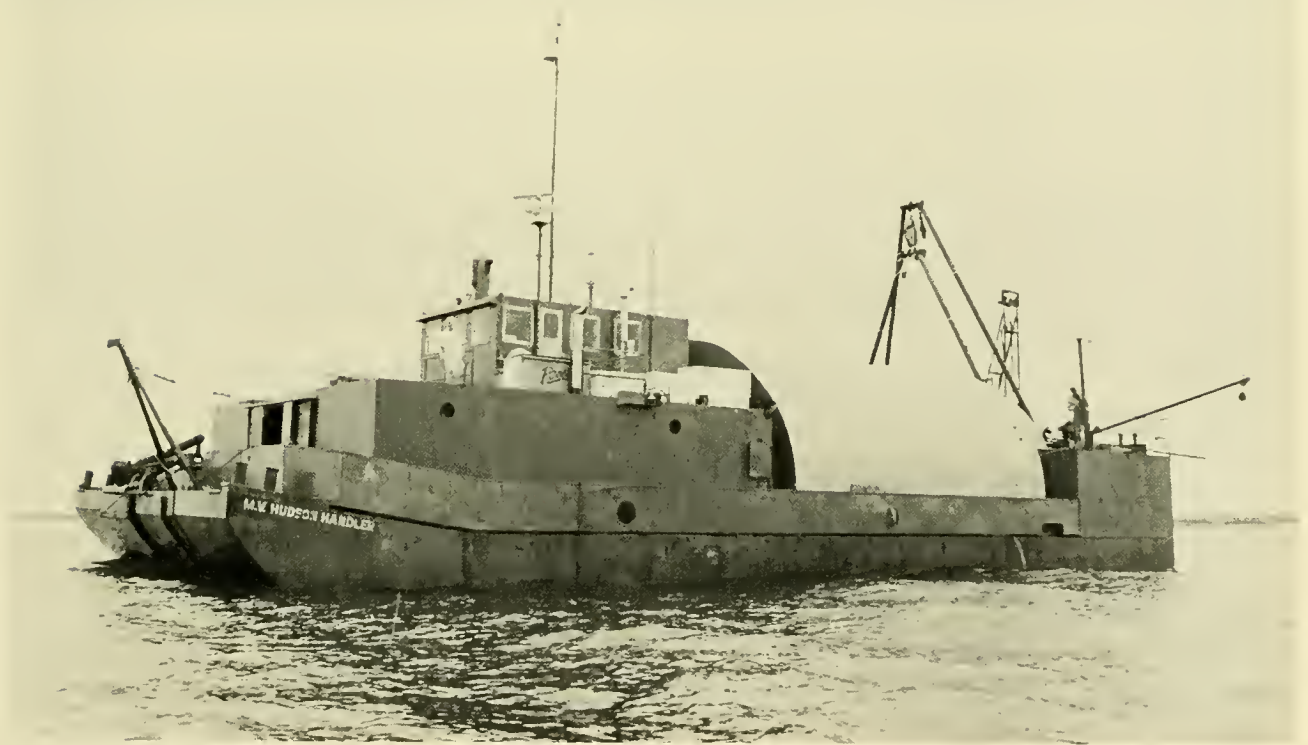

M/V HUDSON HANDLER



M/V VICKERS VENTURER



USS PIGEON (ASR-21)

Fig. 12.7 Submersibles' support craft.



M/V SWAN

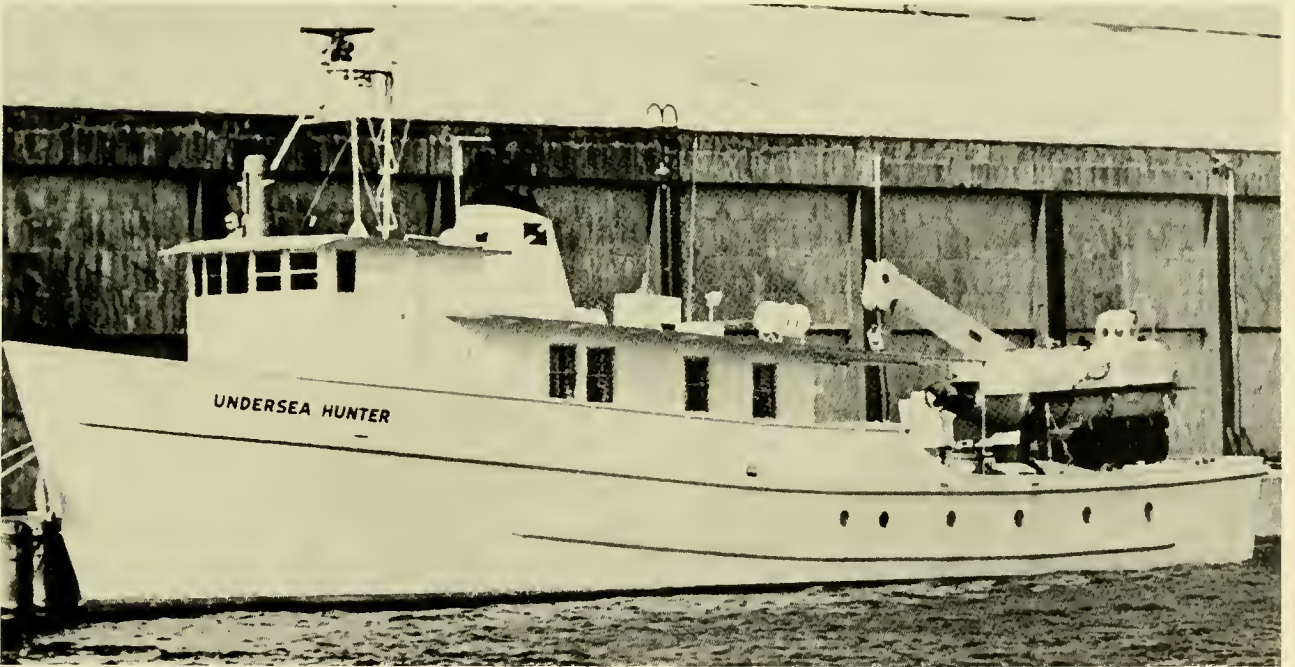

M/V UNDERSEA HUNTER

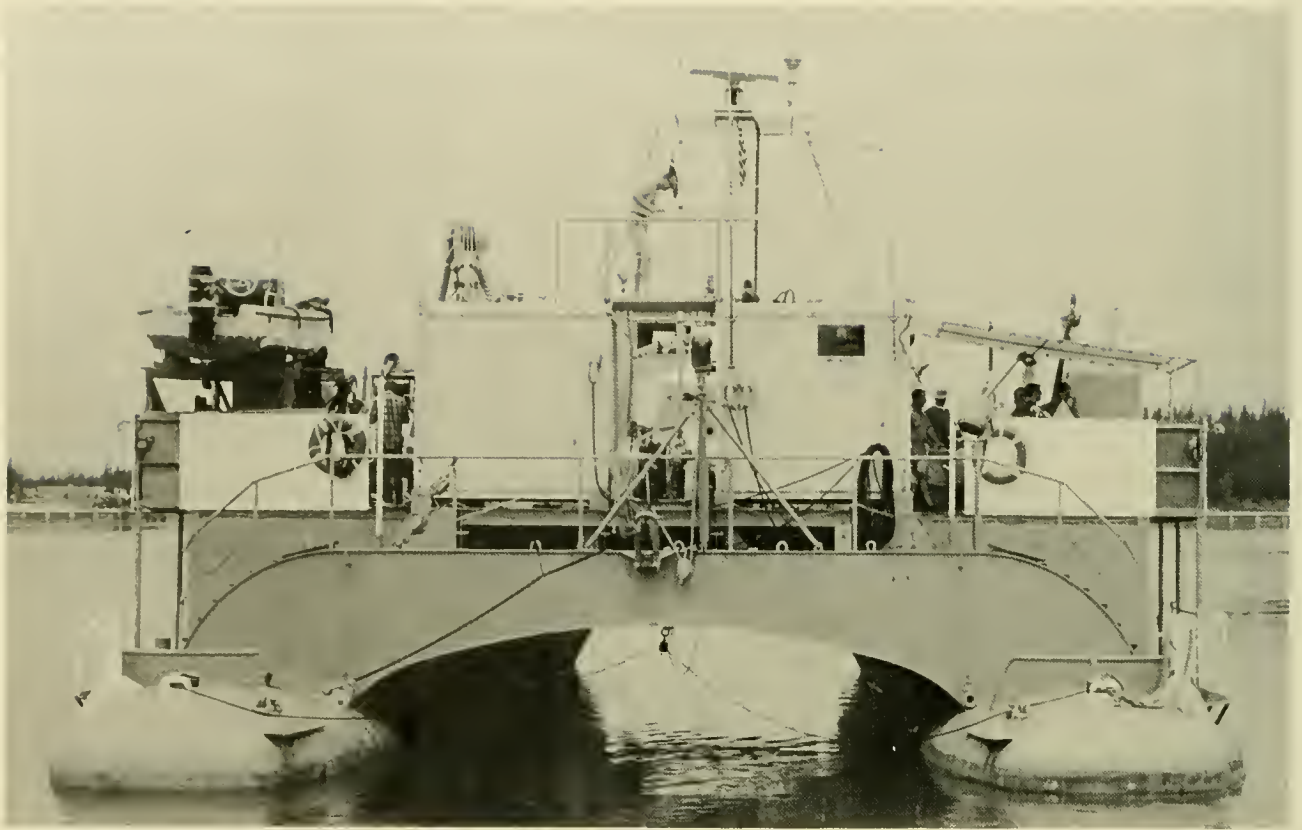

DSRVT LULU



MV PRIVATEER

Fig 128 Submersibles' support craft.



M/V SEAMARK



M/V SEA HUNTER

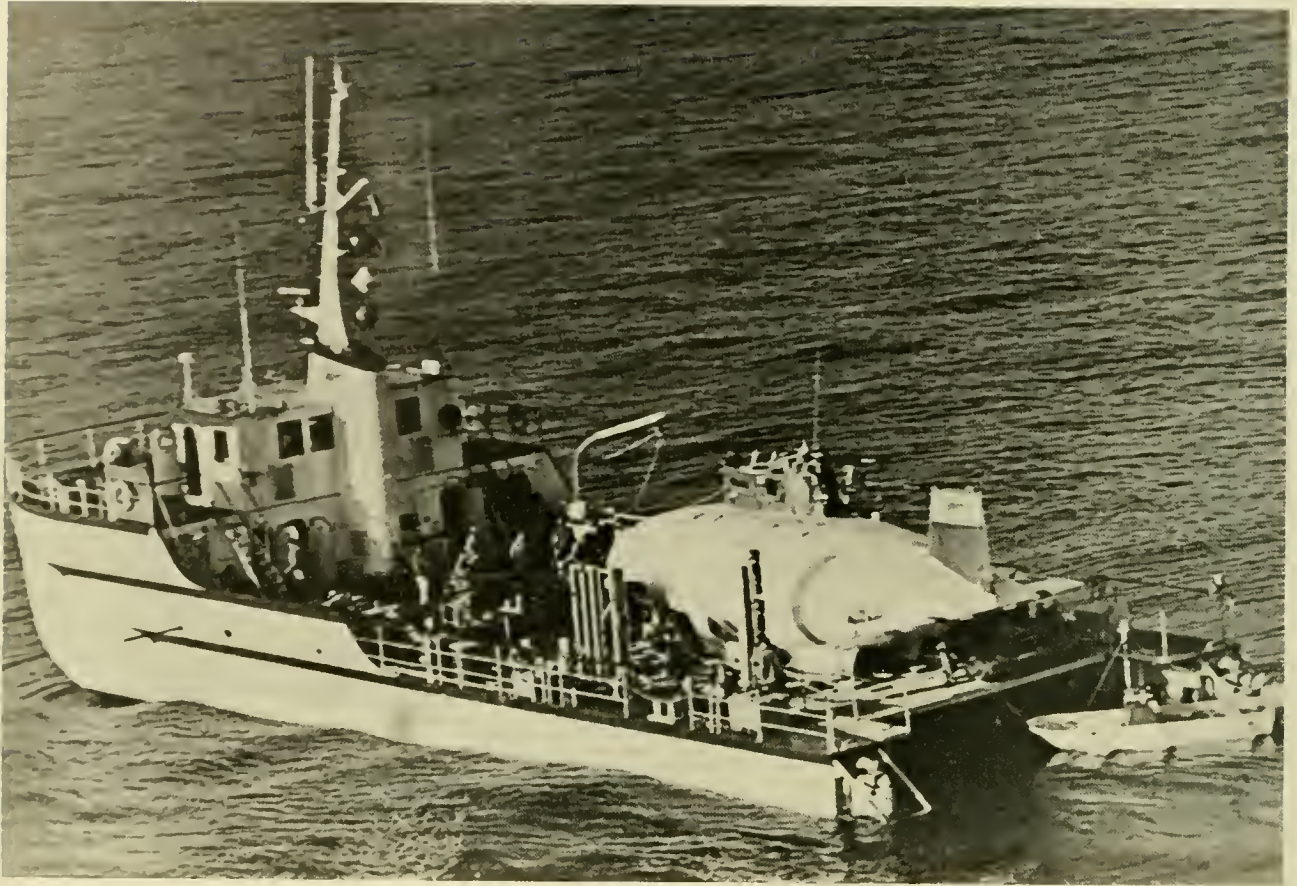

M/V TRANSQUEST

mersible owner and equipped with a launch/retrieval apparatus for a particular contract or testing period. Examples of these are Westinghouse's *SEARCHTIDE*, General Dynamics' *GEMINI* and *SEA CLIFF* and *TURTLE'S MAXINE D*.

Equipment and facilities aboard the support platform are governed by operational and submersible requirements. Battery chargers, air compressors, routine maintenance and minor repair facilities, dark rooms, data processing rooms, instrument repair and maintenance rooms may be provided by permanent accommodations such as on *ALUMINAUT's R/V, PRIVATEER*, or provided by mobile vans such as those mounted aboard *SEARCHTIDE*. During a long-term torpedo retrieval contract in Howe Sound, British Columbia, *PISCES I* and *II* were supported by an anchored barge (Figure 12.9). They were launched therefrom into the

water and towed several miles by a small boat to the dive site. These examples are used to demonstrate that there is very little in the way of "standard" submersible support, and that the requirements change from job to job and from area to area.

A list of the platforms which have supported specific submersibles is presented in Table 12.2. Also included are their specifications and launch/retrieval systems. To list all the support equipment aboard a particular platform at a given time would only reflect the requirements of a particular job. There are, however, standard equipments which an independently-operating support platform carries when divorced from daily shore support. In addition to these equipments a sea-going ship normally carries ship-to-shore communications, electronic navigation, radar, echo sounders, etc. The following are carried specifically for submersible support:



Fig. 12.9 *PISCES II* and its support barge in British Columbia. (International Hydrodynamics)

TABLE 12.2 CHARACTERISTICS OF SUPPORT PLATFORMS

Platform	Submersible	Length			Gross Tonnage	Cruise Speed (Knots)	Cruise Range	Passenger Accommod. <sup>1</sup>	Launch Retrieval Systems	Remarks
		Overall (Ft)	(Ft) Beam	(Ft) Draft						
CALYPSO	SP-350	138	24	10	360	12	5,000 nm	10	Articulated Crane	Conventional Hull
	SP-500						18 days		Overhead Rail	
DAWN STAR	NEKTON	52	16	5.75	45	8	2,300 nm 14 days	11	Nonarticulated Crane	Conventional Hull (leased)
GEMINI <sup>3</sup>	STAR III	142.5	36	10	181	11.5	N/A	N/A	Submerged Platform	Submarine
HAWKSBILL <sup>4</sup>	DSRV	292	32	26	3860 (displ.)	15 <sup>2</sup>	N/A	N/A	Ramp	Barge-Type Hull
HUOSON HANDLER	PISCES	90	38	9.75	340		30 days			
LULU	ALVIN	98	48	9	350 (displ.)	6	1,200 nm	15	Cradle	Catamaran
MAXINE D	SEA CLIFF TURTLE	165	38	11	198	12	5,000 nm	4	Nonarticulated Crane	Conventional Hull (leased)
PIGEON (ASR-21)	DSRV	251	85	19	4200	13	10,000 nm	14	Cradle (Submerged)	Catamaran
PRIVATEER <sup>3</sup>	ALUMINAUT	136	25	9	250	10	N/A	9	Tow	Conventional Hull
R/V JOHNSON	SEA LINK	124	24.5	10.8	210	N/A	N/A	15	Articulated Crane	Conventional Hull
SEA HUNTER <sup>3</sup>	Perry Vehicles	65	14	6.5	75	8	3,000 nm 10 days	5	Stiff Leg Boom	Conventional Hull
SEAMARK	NEKTON	109	24	8.7	177	10	4,000 nm 30 days	N/A	Nonarticulated Crane	Conventional Hull
SEARCHSTAR <sup>3</sup>	DEEPSTAR 2000	40	20	5	30	6	30 hours	0	Cradle	Catamaran
SEARCHTIDE <sup>3</sup>	DEEPSTAR 4000	155	36	11	199	12	5,000 nm	12	Articulated Crane	Conventional Hull (leased)
SWAN <sup>3</sup>	DOWB	136	25	9	250	12	N/A	10 (est.)	Overhead Rail	Conventional Hull
TRANSQUEST	DEEP QUEST	108	39	7	176	6.5	1,500 nm 14 days	12	Cradle	Conventional Forward Hull Catamaran Stern
UNDERSEA HUNTER	Perry Vehicles	8.5	24	7.5	174	10	3,000 nm 21 days	12	Nonarticulated Crane	Conventional Hull
VICKERS	VOL-L1				630				Stern "A"	
VENTURE <sup>5</sup>	PISCES	118	25	12	(displ.)	10	21 days	8	Frame	Conventional Hull
WHITESANDS	TRIESTE II	491	81	15	3000	5	60 days	4	Docking Well Lift	Floating Dry Dock Towed By USS Apache (ATF-67)

<sup>1</sup> Over and above ship & submersible crew accommodations

<sup>2</sup> Submerged speed; with DSRV surface speed 5 knots

<sup>3</sup> No longer operating as support ship

<sup>4</sup> Test and Evaluation Platform

<sup>5</sup> The much larger VICKERS VOYAGER also supports these vehicles

- a. battery chargers
- b. air compressors
- c. scuba equipment
- d. submersible tracking system
- e. small boat or rubber raft
- f. citizen band radio
- g. launch/retrieval apparatus
- h. underwater telephone

In addition the support platform generally includes a space suitable for a dark room, "customer" work space and space for instrument maintenance or repair. One of the more convenient type of ships for submersible support is the oil supply boat such as **SEARCH-TIDE**. Owing to its uncluttered and ample deck space, portable vans may be placed

aboard to accommodate virtually any requirement, while at the same time allow space for launch/retrieval apparatus and operations.

## LAUNCH/RETRIEVAL METHODS

*"On occasion the sub (PC3-B) would appear to be in imminent danger of being dashed against the side of the ship, only to have the hook suddenly take hold and pull her free of the water. Other times she was not so fortunate. On one particularly rough*



*day the sub passed under the hook while in the trough of a large swell, and the man on top of her was unable to reach the hook with the bridle. As she was lifted up by the next swell she was out of range of the hook. The man aboard ship who was tending the forward steadying line saw what had happened, and immediately took a strain on the line, intending to pull the sub back into position under the hook. Of course he succeeded only in pulling her into the side of the ship, where she was severely scraped and banged against the hull.*

*A similar incident nearly occurred about a month later when operating off the ALBANY. This time the crew had been well briefed beforehand that if the pilot missed the hook on his first pass they were to give plenty of slack in the steadying lines to allow him to maneuver back into position. Inevitably, one rough day we missed the hook, and the man tending the after steadying line immediately threw the line into the sea. CUBMARINE, backing away from the ship at the time, backed over the free floating line, and fouled her screw. This left her with no maneuvering power. Fortunately, the ALBANY deck crew was successful in pulling her under the hook by using the forward steadying line.*

*More than once a steadying line fouled or broke loose. Then the sub would pivot on the hook and her bow or stern would crash into the side of the ship. The momentum gained by the free-swinging, three-ton submarine was certain to cause damage. The bow was damaged twice. Once the propeller of the thruster motor was snapped off, and the other time a bowplane guard was bent out of alignment. The stern took even more punishment. One blow damaged the rudder and snapped the rudder pin. Another one twisted the entire rudder assembly some five degrees out of alignment. It was a tribute to CUBMARINE's rugged design that no diving time was lost due to damage.*

*No matter what damage occurred, the crew managed to have her ready to go by diving time the next day." (3)*

From the very beginning—as John Barringer's description of *PC-3B*'s Spanish operation testifies—the air-sea interface proved as hostile as the great depths. Indeed, once the more obvious problems of deep submergence were overcome, the apparently simpler tasks of transporting the submersible to, and launch/retrieval at, the dive site proved to be and remains a major limiting factor.

Few published reports deal directly with launch/retrieval, although past and present inadequacies are readily acknowledged within the submersible community. In 1967 Mr. D. B. Usry, Jr., of Westinghouse compiled *A Survey of Launch-Recovery Concepts & Systems for DEEPSTAR Vehicles* which summarized the various approaches and concepts relative to at-sea handling of submersible craft. This report was not published, and it is unfortunate because it is an excellent summary of the state-of-the-art and the requirements of a successful launch/retrieval system. Mr. Usry has made this report available and a great number of his observations and data are included herein.

C. W. Bascom (4) described typical support ships and handling systems for vehicles operational in 1968. Bascom's report is one of the first, if not the only, published attempt to summarize what was then being used and the many factors involved in at-sea submersible deployment. Bascom also presents a method of predicting dynamic loads on handling equipment and breaks down the costs of major subsystem acquisition and operation (Fig. 12.10 a&b). Bascom's cost breakdowns reveal, what might be termed, enlightening aspects of a submersible program. In short: Operating a submersible is no mean financial feat. Bascom acknowledges that these are rough approximations and, although not stated, it is assumed represents a large corporation's (General Dynamics) approach, which can differ from the small industrial builder/operator. Nonetheless, the conclusion, as any parent will agree, is inescapable: Creation of the progeny is the least expensive; it's the care and raising that extracts a frightening toll.

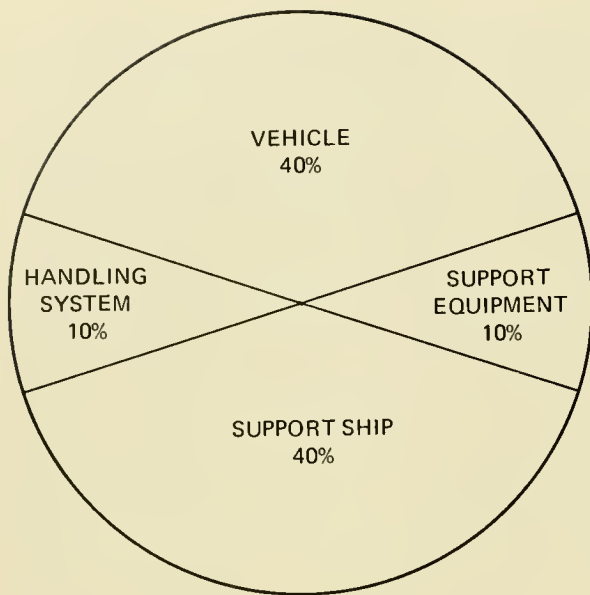

a RELATIVE COSTS OF ACQUISITION OF SMALL VEHICLE WORK SYSTEMS

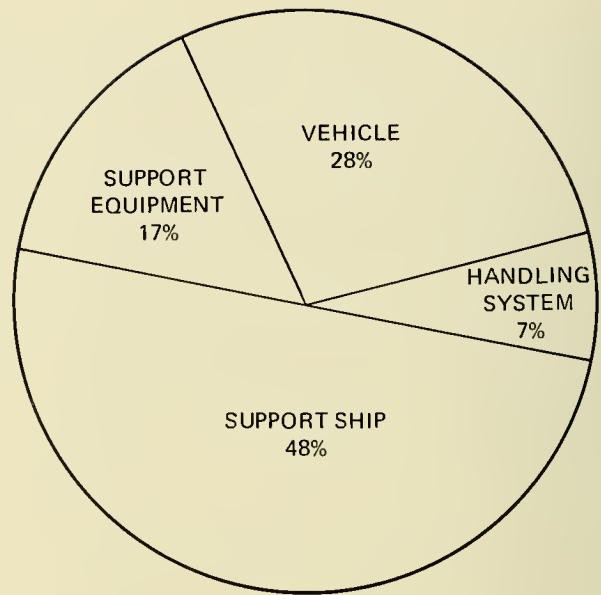

b RELATIVE OPERATING COSTS OF SMALL VEHICLE WORK SYSTEMS

Fig. 12.10 Cost percentages of submersible system acquisition and operation. [After Bascom (4)]

Doerschuk *et al.* (5) performed a detailed analysis of over-the-side handling concepts of the U.S. Navy's Deep Dive System-MK 1 (*DDS-1*). The approach used was to evaluate every feasible arrangement and to derive one which included features of systems which were not desirable *in toto*, but contained individual features which were desirable to the final solution. The investigators had one major advantage; the *DDS-1* is always connected to its support craft by a lift cable, submersibles are not, and attachment of the lift cable is an evolution equal in magnitude to the lift itself. Their analysis, however, is directly applicable to submersible launch/retrieval once the lift commences. Indeed, these analyses were sufficiently detailed and conclusive to prompt Vickers Oceanics into selecting the stern-mounted U-frame (with modifications) as their method of launch/retrieval (6).

In 1969 the U.S. Navy's Deep Submergence Systems Project awarded a contract to the Makai Range Inc. of Hawaii to perform at-sea tests and evaluation of a system Makai Range developed known as the Launch, Re-

covery and Transport (*LRT*) vehicle. The *LRT* was a catamaran platform which could submerge, hover and ascend to the surface. The submersibles *NEKTON ALPHA* and *STAR II* were launched and retrieved underwater from the *LRT* as part of the test program (7). Apparently impressed with the potential of the *LRT*, the Navy proceeded to construct the Launch and Recovery Platform (*LARP*) in 1970 to handle *MAKAKAI* and *DEEP VIEW*. *LARP* is essentially similar to the *LRT*, but differs in materials, air transportability and an optional remote control feature. Subsequently, *MAKAKAI* and the unmanned *CURV III* were deployed from *LARP* and, while there were drawbacks, the system demonstrated its practicality. Not a great deal has been heard of *LARP* since Estabrook and Horn's report (8) which describes it and events leading to its development, and with the laying up of the Navy's small submersibles *MAKAKAI* and *DEEP VIEW* in 1973, it is assumed that nothing further has occurred to improve or advance this concept.

Because of the variety of submersible con-

figurations and operational capabilities, selection of a launch/retrieval system is on an individual basis. Some vehicles are so large and heavy that it is impractical to consider lifting them out of the water after each dive; others, although smaller, are sufficiently large so that the only feasible method is to employ a cradle as with *DEEP QUEST* or *ALVIN*. With the smaller vehicles a single point attachment can be used, but protruding instruments or controls may require some vehicles to lay off several feet from the support platform, while others can come quite close. In some submersibles the operator can work in concert with the support platform's Master to effect attachment and retrieval; in others, the operator can do no more than surface and wait for the support crew to retrieve his vehicle.

Further constraints and considerations in the choice of launch/retrieval systems arise from the owner's or user's method of operation. For example, if the user owns the submersible's support craft, then the launch/retrieval apparatus can be permanently installed. If one uses a different platform for different operations, then the launch/retrieval system must be air or truck transportable, easily installed and require little, or nothing, in the way of shipboard modifications. Such vehicle characteristics and operational procedures preclude an across-the-board solution to launch/retrieval.

Possibly the greatest problems are derived from the fact that the launch/retrieval system, like the support platform, has not been considered until after the submersible is designed or constructed. In Doerschuk *et al.* (5) several systems which showed promise had

to be abandoned because the procedure might damage external instruments or components on the *DDS-1* by bringing its sides into contact with a part of the retrieval system. If the *DDS-1* had been designed with the launch/retrieval system in mind, such protruberances might have been avoided or protected in such a way as not to interfere with the retrieving systems. But the real-life situation is generally the opposite and one must devise a system that does not jeopardize the existing vehicle.

Usry's report summarizes parameters which he evolved in seeking a solution to *DEEPSTAR's* handling system; these are presented in Table 12.3. It should be noted that these parameters reflect a system that will be used on different platforms and in the open sea. A list of system elements (Table 12.4) represents factors concerning the vehicle, the platform, personnel and safety which must be considered in relation to the launch/retrieval system; this table was also taken, in part, from Usry's report and is included to show the many design and operational aspects one must satisfy.

The major adversary to any launch/retrieval system is the state of the sea. Mr. F. Willet of Westinghouse has made the following calculations which illustrate the problem. Presume an 8-foot-high wave of 5.4-second period and 102-foot length. This short wavelength will move the stern of the vessel and the submersible in relation to each other. The stern will plunge as the submersible is on the crest and heave as the submersible is in the trough. With their cycle of motion about 90 degrees out of phase and assuming an 8-foot submersible vertical mo-

TABLE 12.3 SELECTION PARAMETERS FOR HANDLING CONCEPTS

---

<ul style="list-style-type: none"> <li>-transportable by air or truck</li> <li>-maximum safety and reliability</li> <li>-easy installation on variety of ships and platforms</li> <li>-back-up provisions</li> <li>-smooth, positive control</li> <li>-rapid hoist from water</li> <li>-operate in variety of sea states</li> <li style="padding-left: 20px;">reducing relative motion effects</li> <li>-operated without extensive training</li> </ul>	<ul style="list-style-type: none"> <li>-accommodate variety of vehicles</li> <li>-simple design, standard parts</li> <li>-reasonable cost</li> <li>-no additional personnel required</li> <li>-no positive action required of vehicle being recovered</li> <li>-not require swimmers for critical attachments or maneuvers</li> <li>-utilize minimum deck space</li> </ul>	<ul style="list-style-type: none"> <li>-require no modification to mounting platform or ship</li> <li>-minimum maintenance and equipment</li> <li>-no inhibiting effect on vehicle design</li> <li>-reduce need for critical skills on part of ship operator</li> <li>-minimize handling effects on vehicle</li> <li>-useful for other equipment handling</li> <li>-power source requirements</li> </ul>
---------------------------------------------------------------------------------------------------------------------------------------------------------------------------------------------------------------------------------------------------------------------------------------------------------------------------------------------------------------------------------------------------------------------------------------------------------	----------------------------------------------------------------------------------------------------------------------------------------------------------------------------------------------------------------------------------------------------------------------------------------------------------------------------------------------------------------------------	----------------------------------------------------------------------------------------------------------------------------------------------------------------------------------------------------------------------------------------------------------------------------------------------------------------------------------------------------------------------------------------------------------

---

TABLE 12.4 DETAILED SYSTEM ELEMENTS

	Safety			Platform
Certification requirements		Platform Behavior	Sea-keeping behavior	Electrical power available
Operator training		Tests and Maintenance	Maneuverability	Configuration
Back-up systems		Reliability	Deck space	Operating personnel
Vehicle capability		Casualty Analysis	Freeboard	Length, beam and draft
Construction criteria		Affect on Platform	Ballasting and stability	Deck reinforcement
Operating Area				
	Vehicle		Personnel	
Size		Attachment points	Manpower profiles	Insurance
Weight		Special attachments	System complexity	Special training
Configuration		Vehicle behavior in water	Maintenance	Human factors in design
In-air trim		Visibility		

tion and 10-foot ship motion (both 5.4-second periods), this will create a maximum relative velocity of 8 to 9 feet/second. Furthermore, when the submersible is out of the water and supported by the handling system, rolling, pitching and heaving of the ship imparts an unpredictable motion to the submersible which consequently must be restrained.

The following pages describe approaches various groups have taken to surmount the air-sea interface. The only method which seems to avoid all compromises and offers a solution to all vehicles is to launch and retrieve underwater from a support submarine; the *DSRV* has done just this using the attack submarine *HAWKSBILL*. Attack submarines start at about \$180 million. Undoubtedly privately-owned surface-oriented support systems will dominate for some time to come.

### Methods In Use

Following is a brief summary of the procedures followed during launch/retrieval with the systems shown in Figures 12.11 through 12.13.

**Non-Articulated Boom** (Fig. 12.11): Several submersibles use this system; the main problems are overcoming pendulum motion and detaching/attaching the lifting hook. The *STAR III* system employs a 12-ton, non-articulated boom for lift and three small tugging winches to steady the submersible. When the submersible is in the water, divers release the steadying lines (4 points) and the lift lines (4 points). Retrieval is more difficult

than launch owing to diver attachment of the lines on a generally rolling, pitching and slippery submersible and especially when the attachment of the lift bridle demands extreme alertness on the part of the divers to avoid being hit by the swinging, heavy lift hook. Coordination of the four winch operators places an additional burden on the operation. At times, in moderate sea states (up to 3), the pendulum effect is sufficient to wrap the lift hook around the boom in preparation for lifting, thereby causing additional delays. The submersible pilot's only function in this operation is to maneuver his vehicle as near to the ship as safety allows.

**Articulated Boom** (Fig. 12.11): The *DEEPSTAR 4000* system employs a modified Koehring, articulated crane with a lift capacity of 25 tons. Because the boom end is closer to the submersible there is less pendulum motion. A winch operator and two man-controlled steadying lines are involved when the vehicle is in air. When placed in the water (*DEEPSTAR* is negatively buoyant) the lift hook is tripped, but the vehicle remains tethered by a line to the ship which a diver releases after performing pre-dive checkouts underwater. Retrieval involves swimming a line out to the surfaced submersible and, after attachment, hauling the vehicle close enough to the ship to connect the lift hook. Placement of the submersible in its onboard cradle is expedited by a pneumatic skirt on the cradle which inflates to join with the vehicle. The pilot's role during the entire operation is passive.



Non-articulated Boom



Articulated Boom



Articulated Boom



Overhead Rail

Fig. 12.11 Launch/retrieval systems.

A modification of this system is employed with the **JOHNSON SEA LINK** (Fig. 12.11) where a universal joint is rigidly coupled to the armtip. A diver is required to attach bow and stern steadying lines and to insert a special hooking device into a housing atop the submersible. The pilot's role is to maneuver the submersible to a convenient point astern of the ship. The entire procedure is performed underway at low speed and expedited by the fact that the boom need only be retracted or extended along the fore and aft line of the ship. In other boom systems the vehicle pad location requires swinging the crane through the ship's roll plane.

**Overhead Rail** (Fig. 12.11): The **DOWB** and **NEKTON** use an overhead fixed rail system.

The pendulum effect can be substantial in this case with the added requirement for greater maneuvering by both the ship and the submersible because of the untrainable nature of the rail.

**Ramp** (Fig. 12.12): International Hydrodynamic's **HUDSON HANDLER** is the only support platform known to use this system. The following description of its launch/retrieval procedure is taken from McFarlane and Trice (9).

*“One module of the vessel is hinged along its foremost transverse, the hinge point being almost exactly midway between the vessel's stem and stern. The module is watertight and contains internal subdivisions. When*

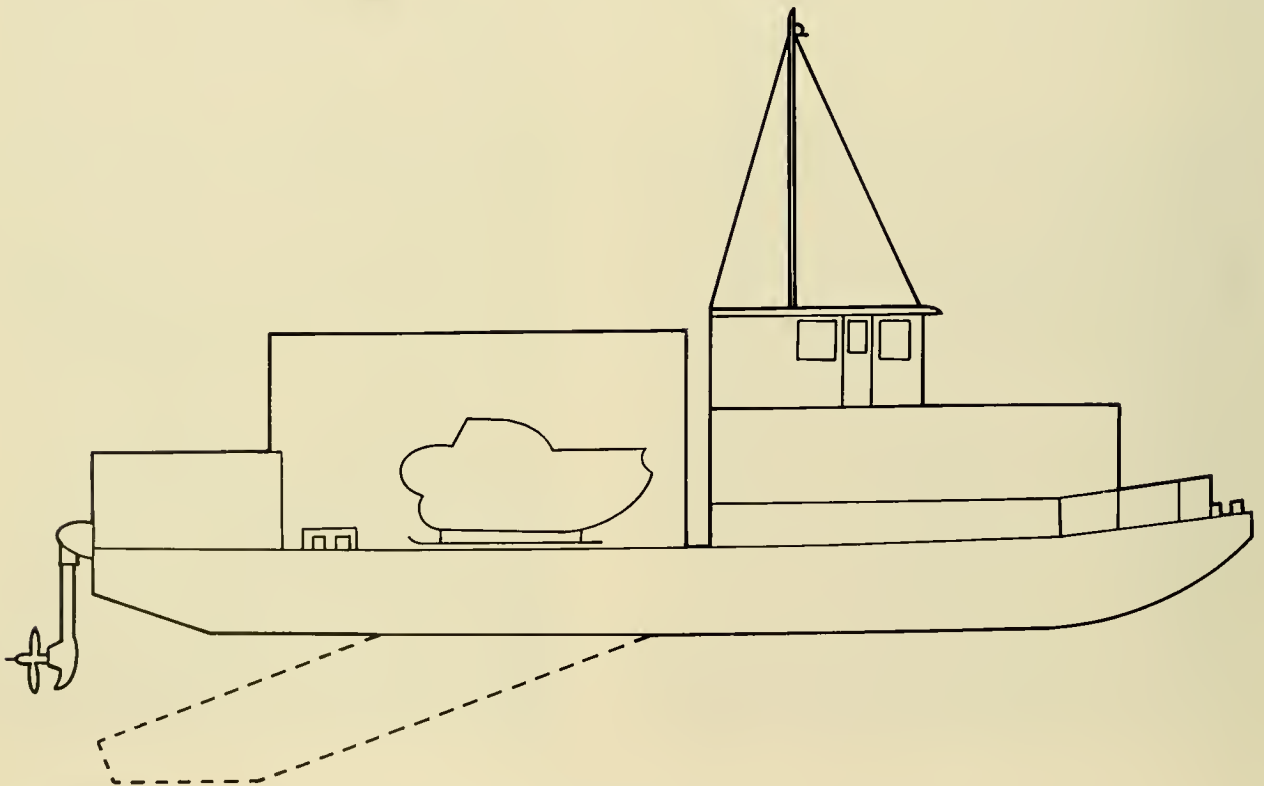
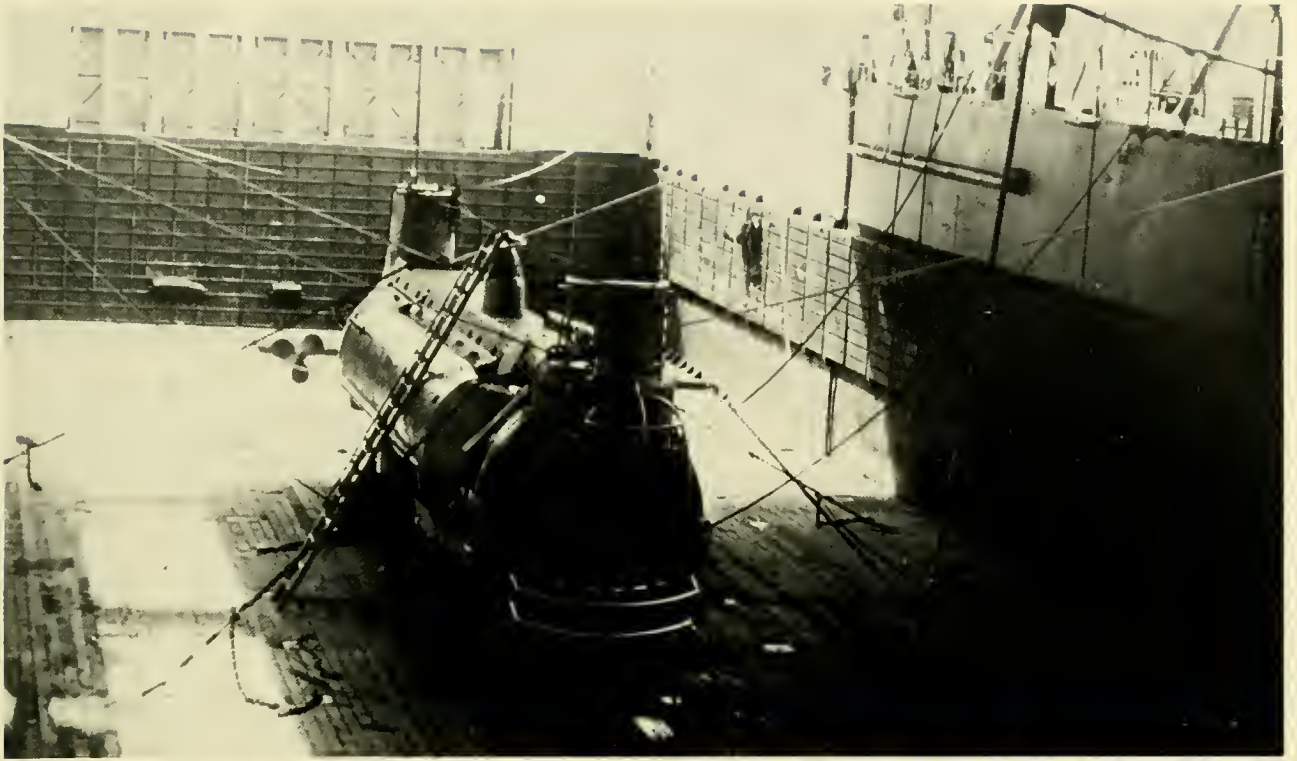

Fig. 12.12 Hinged ramp of HYCO's HUDSON HANDLER.



Docking Well Lift



Catamaran-Submersible Surfaced

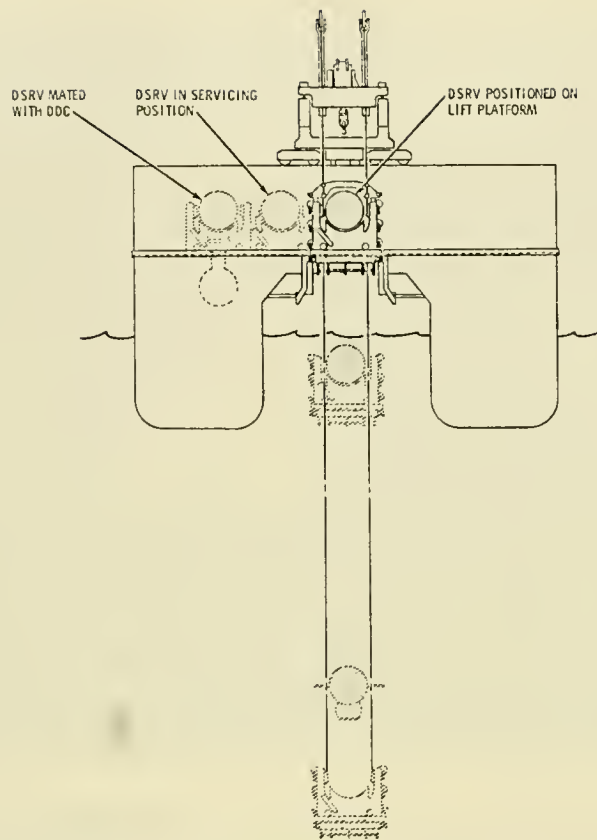

Catamaran-Submersible Submerged



Stern-Mounted A-Frame



*filled with air its deck line is horizontal and co-planar with the deck level of the vessel. When partially flooded the stern end sinks some 17 degrees leading into the water. The deck is fitted with rails and a carriage into which the skids of PISCES III fit. The carriage is moved along the rails by a winch and drag line arrangement. When the submersible is on board the support vessel, the carriage is fully forward and locked rigidly in place. To launch the submersible, sufficient water is allowed to flood into the ramp section to submerge its stern end some ten feet below the surface.*

*The carriage is allowed to run aft until the submersible floats free. To recover, a line is used to haul the submersible into the carriage which is then drawn fully forward. The water is blown out of the ramp section which then returns to the horizontal.*

*The stern end of the ramp section is restrained by shock absorbing preventers which, while protecting the ramp from damage, permit it to synchronize relatively well with prevailing wave action. Recoveries in seas with wave amplitudes of up to 3.5 meters have been accomplished."*

**Docking Well Lift** (Fig. 12.12): The only submersible which routinely employs a well lift or **LSD**-type concept for launch/retrieval is the U.S. Navy's **TRIESTE II**. The system is simple in concept but complex in practice. The support ship **WHITESANDS** floods down (25 feet is maximum for **ARD-12**) to a depth where **TRIESTE II** is afloat; prior to this 11 restraining lines are attached. One is a bow line which later serves as a tow line. Four lines on each side are passed aft as the vehicle exits the **WHITESANDS**, and two lines are held by two handling boats which pull **TRIESTE II** out of the well. The bathyscaph cannot use its own power because it is completely deballasted of gasoline and shot for launch and retrieval; this condition puts all propellers above the waterline. As a general operating procedure, if the prevailing wavelength is shorter than the length of the **WHITESANDS** no launching is conducted un-

til either the wavelength increases or the sea calms. The **WHITESANDS** has no propulsion power and is towed by the **USS APACHE (ATF-67)**.

**Catamaran-Submersible Surfaced** (Fig. 12.12): **ALVIN**'s launch/retrieval system uses this approach. It differs from the **DSRV** catamaran system in that the **DSRV** mates with its lifting cradle while submerged; **ALVIN** mates while surfaced. During launch **LULU** is laying to with her bow into the sea, **ALVIN** is then lowered between the hulls on **LULU**'s cable-suspended cradle until it is floating and the cradle is brought to rest some 8 feet below **ALVIN**'s skegs. Six steadying lines, three on each side, are passed aft as **ALVIN** clears the catamaran. Divers aboard the submersible are used to cast off lines and conduct pre-dive checks. Retrieval is accomplished in the reverse fashion with **ALVIN** maneuvering into the catamaran. The operator standing in the submersible's sail directs the entire launch/retrieval operation. Clearance between **ALVIN** and the hulls is about 4.5 feet on each side, which constitutes the major hazard when sea state is high. Launch/retrieval has been conducted up to sea state 4.

**Catamaran-Submersible Submerged** (Fig. 12.12): Though it has not been field tested at present, the **DSRVs** can be launched/retrieved on the surface in an **ALVIN**-like fashion or retrieved below the surface. For subsurface retrieval the catamaran lowers the cradle approximately 100 feet below the surface and, through the use of guide arms and a television system on the platform, the **DSRV** positions itself on the cradle and is hoisted to the surface. The purpose here is to avoid the problems associated with sea state. Subsurface launch and recovery in sea state 3 is considered possible.

**Open Stern Well** (Fig. 12.13): This system is employed by Lockheed's **DEEP QUEST** and is similar to the **ALVIN** catamaran procedure. Within the 62-foot-long, 25-foot-wide open well is a hydraulically-powered elevator platform, 28 feet long and 23 feet wide, capable of lifting 60 long tons. Two handling lines are attached on each side to assure that the submersible does not collide with the sides of the well or the forward bulkhead. Unlike

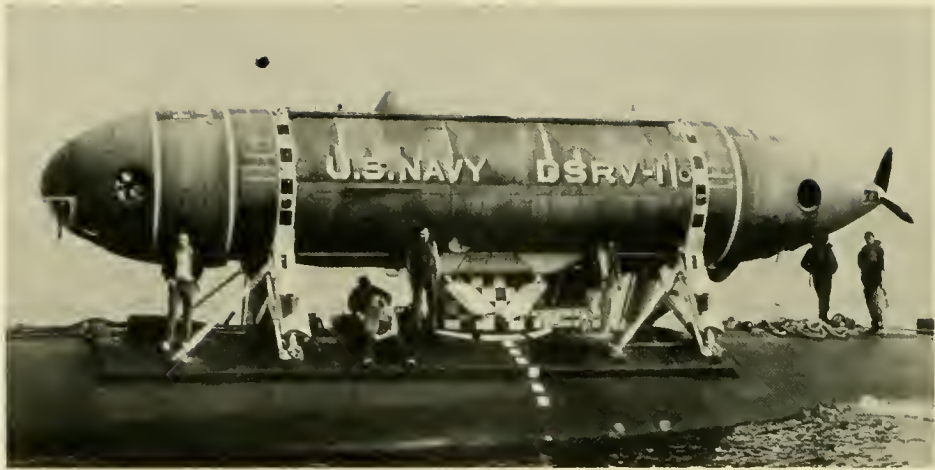

Submarine



Stern A-Frame

Fig. 12 13 Launch/retrieval systems.

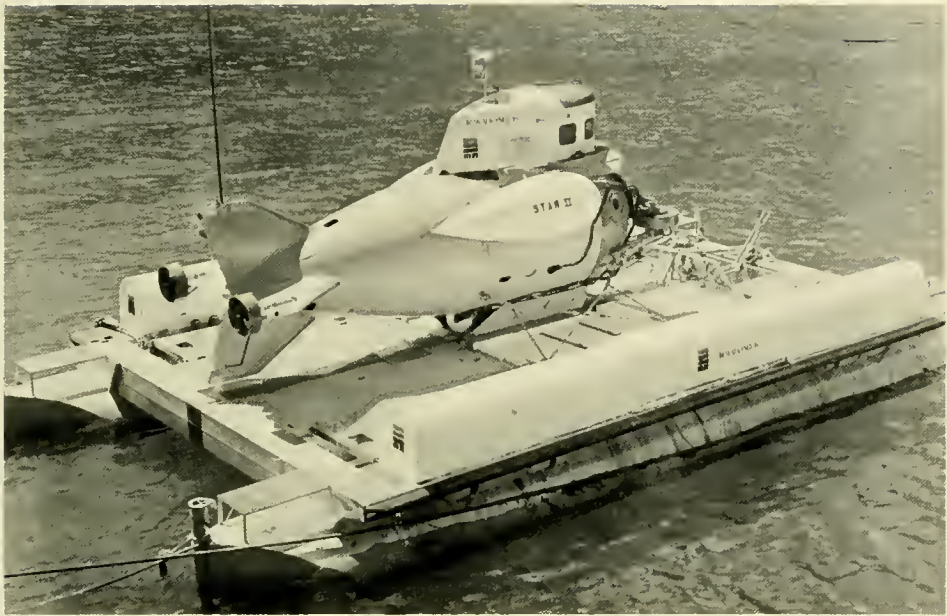

LARP



Open Stern Well

**ALVIN**, a bow line assists the submersible in and out of the well. Rubber fenders line each side of the stern well for additional protection, and a net spans the forward end of the well to protect the bow against collision with the forward bulkhead. During launch, **TRANSQUEST** maintains slight headway and **DEEP QUEST** is essentially paid out of the well; during retrieval **TRANSQUEST** proceeds at 1 to 2 knots into the sea and the bow line is used to haul the submersible into the well. With assistance from the line handlers and the submersible's pilots, it is eased into a position where the cradle (6.5 ft below the keel) can begin to lift. **TRANSQUEST** is designed with four ballast tanks, port and starboard, which permit draft changes from 6.5 to 10 feet to facilitate launch/retrieval.

**Submarine** (Fig. 12.13): Specially modified nuclear submarines can be used for submerged launch and recovery of the U.S. Navy's **DSRVs**. The **DSRV** is placed on the submarine's after rescue hatch at the pier and can be transported at a submerged speed of 15 knots. At the launch site it is unlocked from within the mother submarine to conduct its mission. A transponder on the mother submarine is used by the **DSRV** to locate it for docking. Reflective paint marks obstructions on the submarine and highlights mating areas and guide lights on individual pylons. External television on the **DSRV** is used to monitor final approach and tie down. With the **DSRV** secured to the after hatch, ballast and life support replenishment, battery charging and other servicing and minor repairs can be conducted underwater or on the surface. This system is not restricted by sea state.

**Submerged Platform** (Fig. 12.13): To avoid the turbulence of the surface, the Naval Undersea Center has constructed and tested a towed, underwater, launch/retrieval platform called **LARP** (Launch and Recovery Platform). **LARP** is a catamaran structure consisting of two compartmental cylindrical fiberglass hulls cross-connected by four aluminum pipes; the latter are overlaid by an aluminum grating with appropriate cutouts for controls, etc. Three fiberglass-covered urethane blocks provide buoyancy and stability and house 12 each 200-cubic-foot-capacity

compressed air bottles which serve to deballast the hull. Forward on the platform are remote and manual valves for controlling buoyancy. The platform is presently capable of lifting 10 tons and is 35 feet long, 18 feet wide, 7 feet high and weighs 8.5 tons in air.

During tests **LARP** was towed with a submersible (**MAKAKAI**) aboard. Reaching the dive site the tow ship layed to, and four divers flooded the main ballast compartments and, subsequently, the variable ballast tanks. At 60 to 70 feet deep **LARP** was made to "hover" by control of the variable ballast tanks. The submersible's tie-downs were released by the divers, and the vehicle "flew" off the platform which was then surfaced. Retrieval involved the reverse procedure. Remote control of **LARP's** ballasting/deballasting was possible, but remote control of the tie-downs was not.

A further refinement to **LARP** (in experimental design) is **BALARE** (Buoyancy Actuated Launch and Retrieval Elevator) in which a similar platform is attached by two pivoting, telescoping arms to the stern of the support ship. The hydraulically-operated arms bring the platform close to the support vessel where maintenance/repair can be effected without the use of divers and where the platform, because it is firmly held, assumes the same motion as the support ship.

**Stern-Mounted A-Frame** (Fig. 12.13): Vickers Oceanics employs this system to launch/retrieve their **PISCES** series vehicles from aboard the support ship **VICKERS VOYAGER**. Basically the system works as follows: To retrieve, a line is attached by divers to the vehicle's stern which is used to draw it within hook-up range of a 6-inch wire rope attached by divers to a lift padeye aft of the sail. The lift rope is fairleaded through the apex of the frame and the arm or pendant and is wound about a specially-developed compensating winch which always keeps the rope taut. With the submersible drawn up to the pendant, the pendulum effect is slight and the vehicle is drawn stern-first onto the support craft. Rotation of the submersible in the horizontal is checked by steadying lines attached port and starboard. According to Goudge (6) a 12-ton submersible has been recovered in 14-foot seas and larger swells;

the most important feature of this system is the compensating winch, which ensures that the lift line will never become slack and create massive loads due to wave action.

A variation on this theme is shown in Figure 12.14 which Taylor Divers uses with *TS-1*. Identical in operation to *PISCES*'s handling system, the departure comes in the

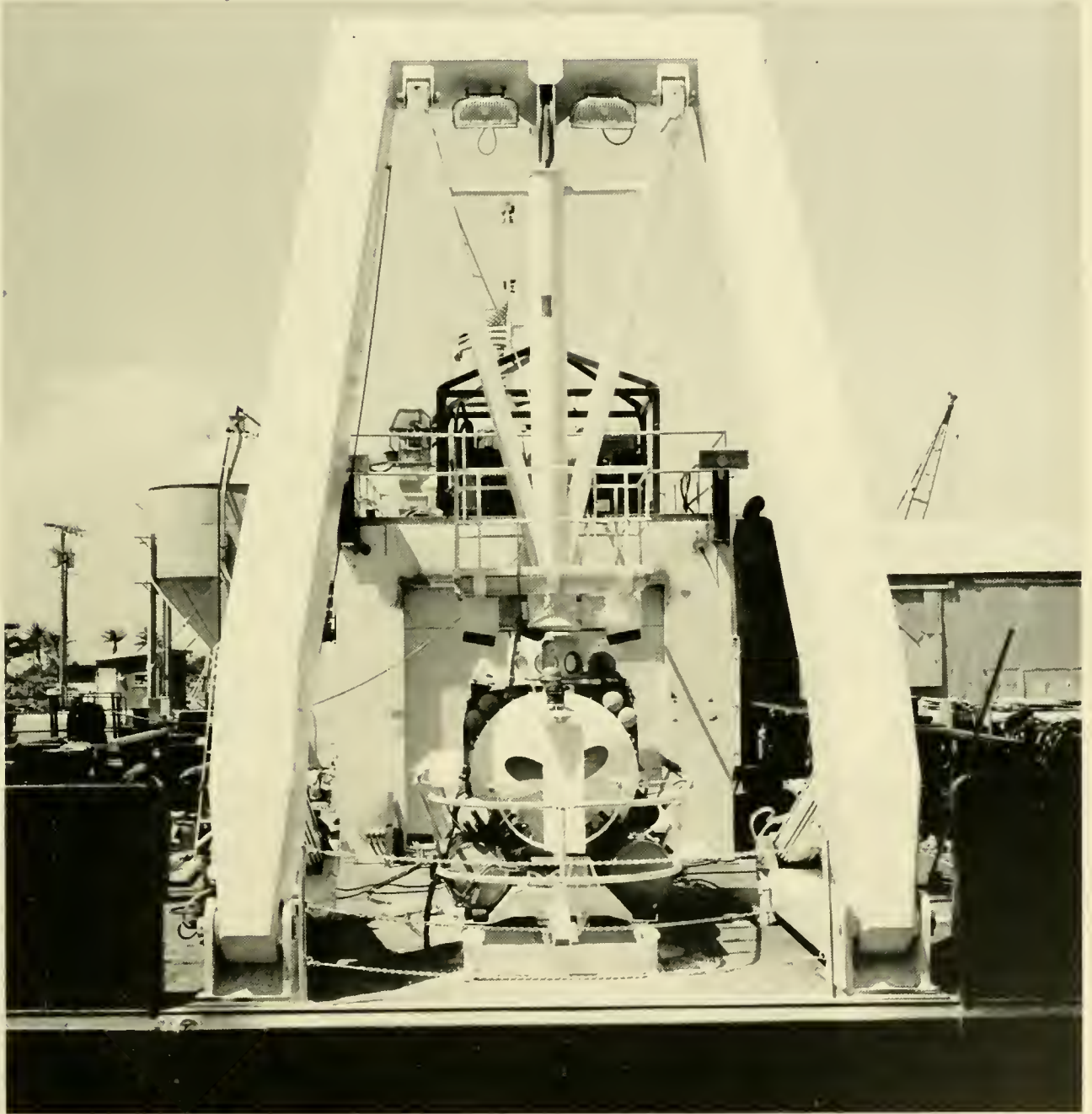

Fig. 12.14 Taylor Diver's hopes to avoid the use of swimmers by stationing an individual in the platform at the base of the pendant to hook up a hauser for retrieval.

method of attaching the lift line. Encompassing the end of the pendant is a platform on which a person stands and manually lowers and attaches the lift line to the submersible directly below. When the attachment is made the submersible is reeled in taut against the pendant and retrieval proceeds as with the *PISCES* vehicles. The point of this approach is to eliminate the need for putting a person in the water.

### Conceptual Launch/Retrieval Methods

Owing to the significant obstacle the sea surface presents to submersible operations, many approaches to launch/retrieval have been conceived. While none of these systems are as desirable as the mother submarine concept, they are within the financial grasp of submersible operators and, because of the importance of the problem, they are catalogued here to acquaint the reader with the many options for handling heavy loads at sea. Whereas the diagrams are generally

self-explanatory, aspects of system pros and cons are briefly discussed.

**Elevator** (Fig. 12.15): Designed by F. Willet (Westinghouse), the system has the advantage of requiring small deck space and of being adaptable to ships of high freeboard. Disadvantages are in the need to use divers in a dangerous area (ship's wake) and in a high degree of maintenance to the many cables and pulleys.

**Floating Dock** (Fig. 12.16): Designed by A. P. Ianuzzi (Westinghouse), the system provides protection to the submersible, but the "moment of truth" (connection of ship to vehicle) at the interface still exists. Studies by A. Vine (Woods Hole Oceanographic Institution) show the "wheel concept" to be applicable to the retrieval of moderate loads (lifeboats, buoys) aboard ship by attaching shock absorbing aircraft wheels to the load itself.

**Stern Crane-Ways** (Fig. 12.17): An AMF Corporation concept envisions mating the submersible rigidly to a lift carriage which is then winched up the craneways and aboard ship. Mating the submersible to the carriage

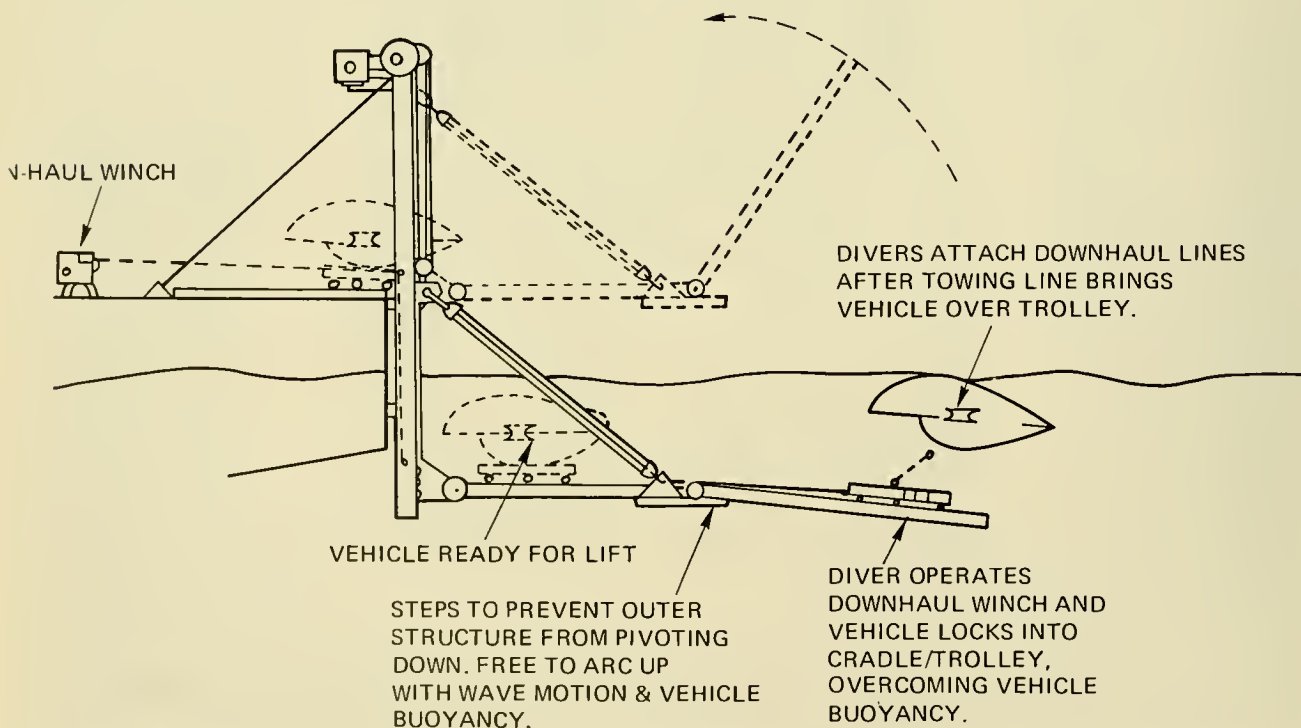

Fig. 12.15 Elevator concept. (F. Willet, Westinghouse)

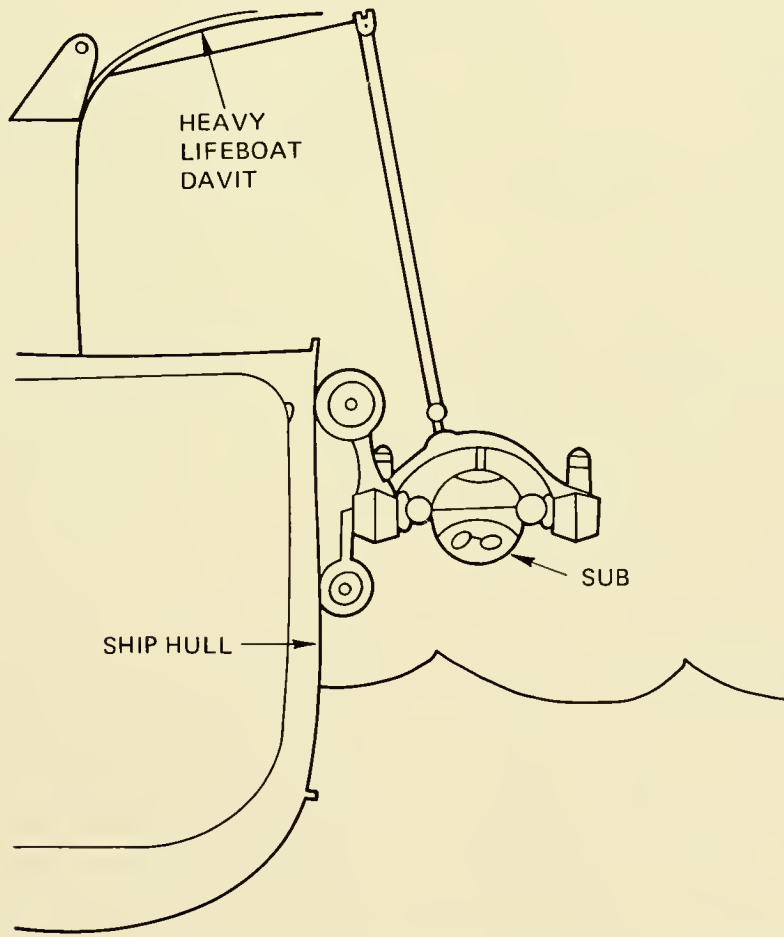
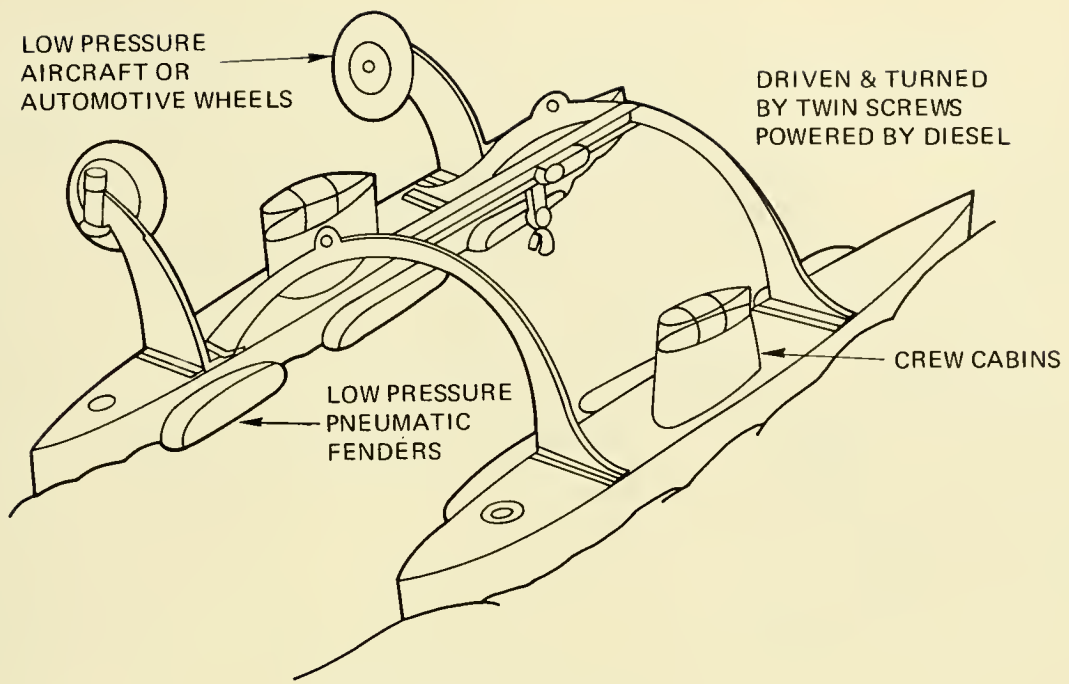

Fig. 12.16 Floating dock concept. (A.P. lanuzzi, Westinghouse)

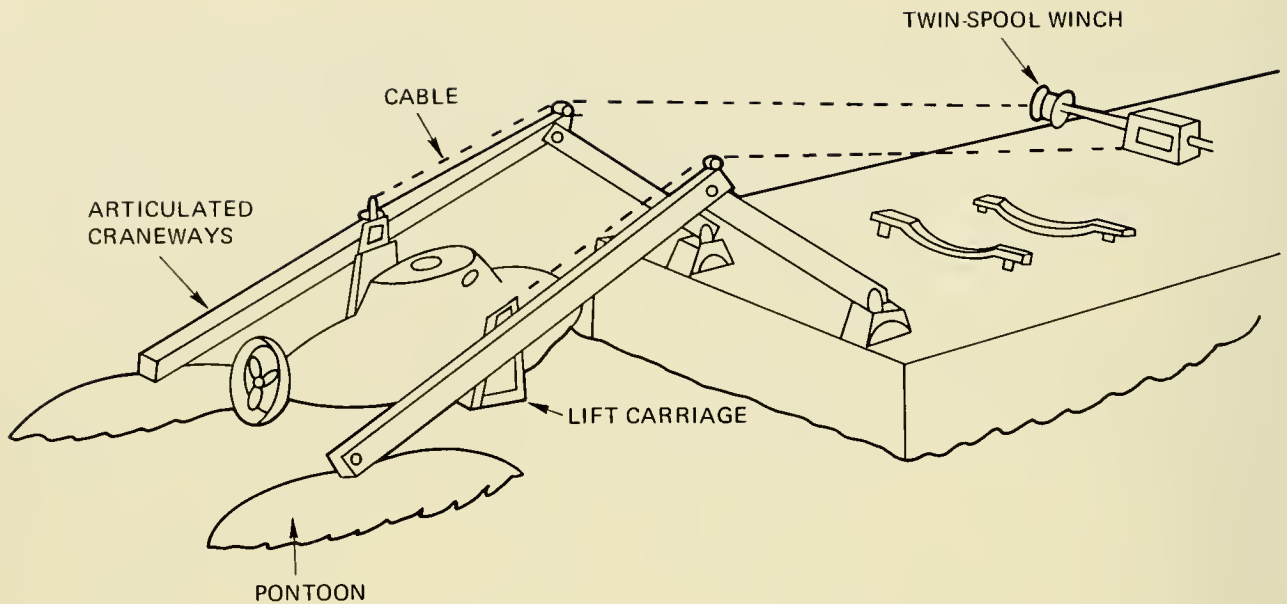

Fig. 12.17 Stern crane-ways concept. (AMF)

appears to be the critical operation in this concept and would likely involve use of divers.

**Drawbridge** (Fig. 12.18): Also designed by A. P. Ianuzzi, the drawbridge system has advantages and disadvantages similar to the AMF and U-frame concepts.

**Stiff-Leg Boom** (Fig. 12.19): One of the most readily available and simple concepts for lifting objects at sea, the stiff-leg boom suffers from all the problems associated with such activities: Pendulum effect, handling when the vehicle is in the air and differential motion between lift device and submersible.

**Constant Tension System** (Fig. 12.20): This was designed by J. T. Leiby (10) to eliminate shock loading on both submersible and lift device, while at the same time controlling pendulum motion. The constant tension device limits the load on the hook to 1.5 times the rated load. A motion restraining device permits vertical heave but restrains horizontal motion. A light "tag" line (nylon) is hooked to the submersible from the ship and the main hook-up (lift) connection is made under constant tension using the tag line as a guide. When lift is started, the constant tension feature is locked in payout mode but still provides pay-in (overhauling) if the vehicle should rise faster than hoisting speed.

Design of the pendulum motion restraining device was not discussed by Leiby.

**Telescoping Boom** (Fig. 12.21): The disadvantages of this approach are as follows: In-haul lines are required to guide the vehicle into hook-in position and, in addition, modification of the lifting points is required. A shock absorber on the grapple is designed to overcome differences in vertical motion between vehicle and crane tip.

**Hinged Ramp** (Fig. 12.22): Proposed by R. Gaul and R. Bradley (Westinghouse), the hinged ramp system seeks to mate the submersible to a submerged, slanting platform which heaves and plunges in concert with the surfaced submersible. Once the submersible is on the ramp, it is winched aboard; during the course of recovery, the roll, heave and mass force of the submersible are gradually transferred to the ship. The ball-in-socket joint de-couples roll between ship and ramp, and hydraulic ramps act first as shock absorbers and subsequently as vertical support when the submersible is drawn out of the water. Movement up the ramp may be over skids or rollers on the submersible (requiring attachment of the heaving cable by divers) or on a specially designed mobile platform to which the submersible mates.

The following launch/retrieval concepts



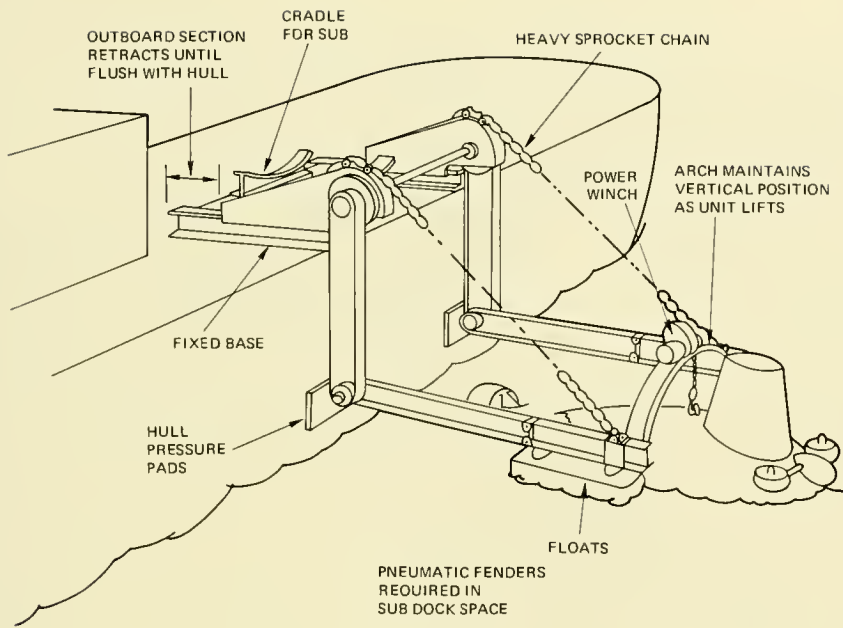

Fig. 12.18 Drawbridge concept (A.P. Januzzi, Westinghouse)

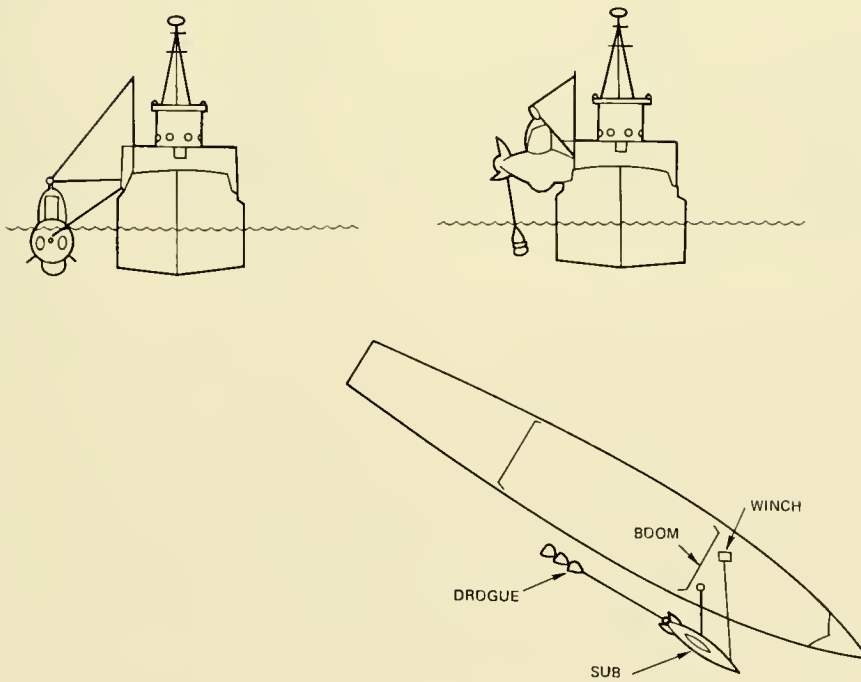

Fig. 12.19 Stiff-leg boom.

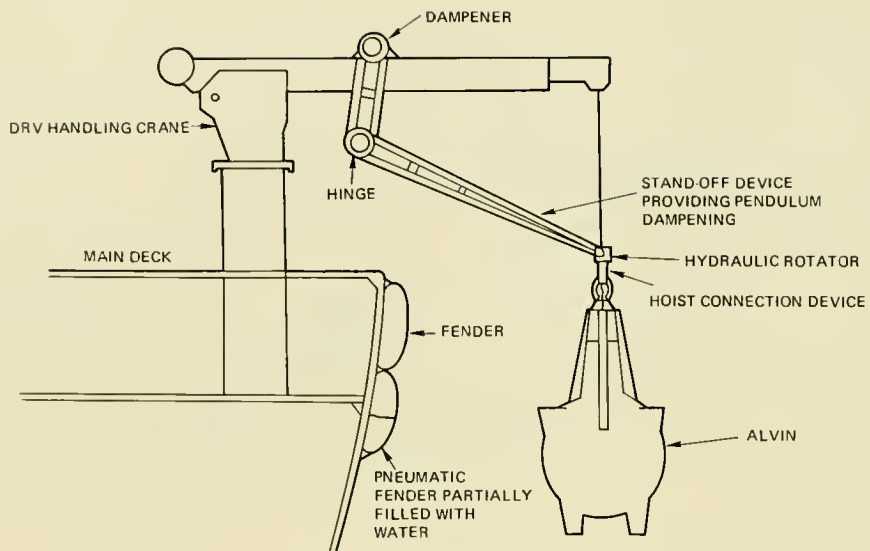

Fig 12.20 Constant tension system. [From Ref. (10)]

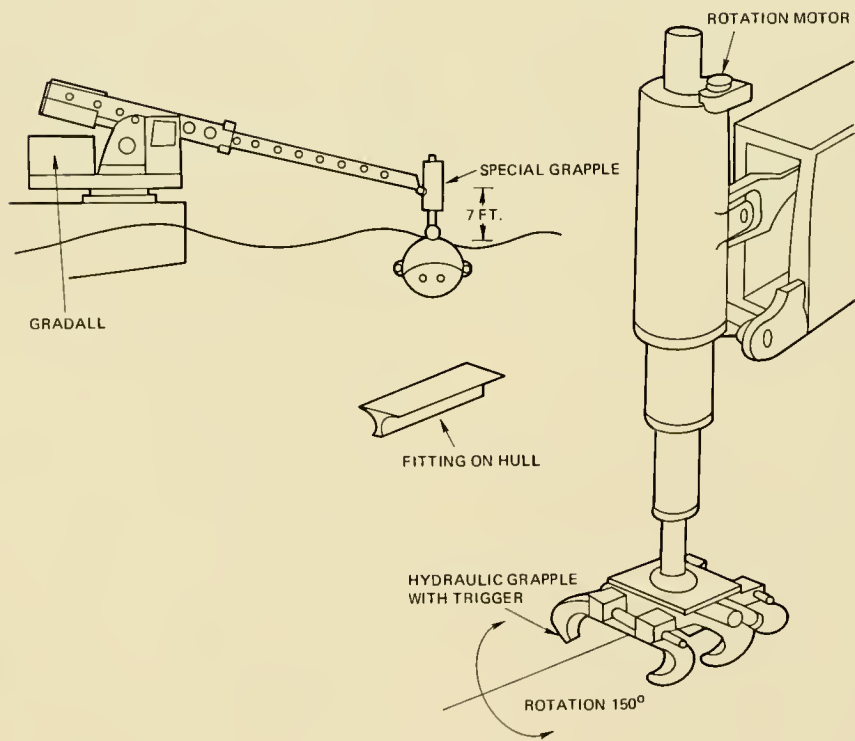

Fig. 12.21 Telescoping boom.

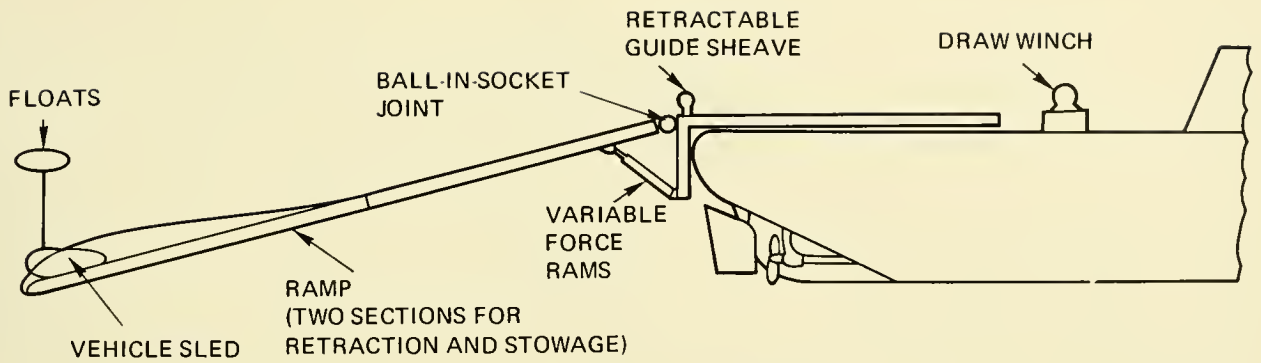

Fig. 12.22 Hinged ramp concept. (Proposed by R. Gaul and R. Bradley, Westinghouse)

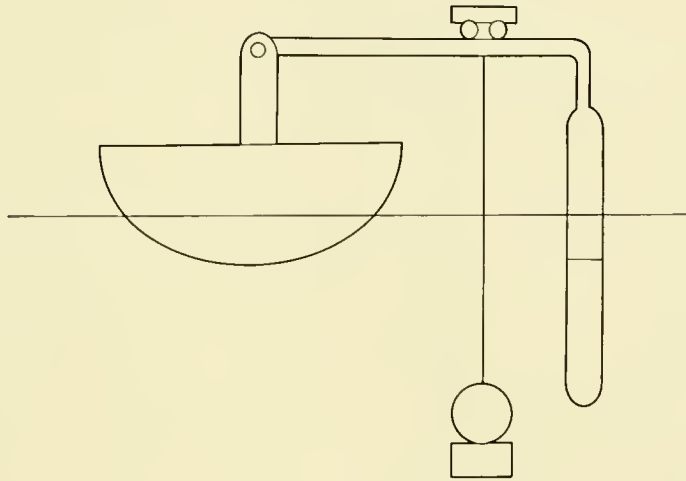

Fig. 12.23 Spar buoy with trolley.

and the accompanying discussion of their pros and cons are taken from Doerschuk *et al.* (5) who, as mentioned previously, performed analyses of many different systems for the U.S. Navy's Personnel Transfer Capsule (PTC).

**Spar Buoy With Trolley** (Fig. 12.23): This system provides a gradual transition from the underwater motion of the vehicle to the motion of the ship. The spar-buoy end of the trolley is stable, while the pinned end is fixed relative to the ship. Deployment and recovery of the vehicle takes place far out on the arm next to the buoy. The vehicle travels to and from this point above water by virtue of an electric or hydraulic trolley. Using a 5-foot-diameter spar buoy, recovery of a vehicle from the water would cause a 20-foot drop in the spar-buoy's vertical position (total weight of vehicle, buoy and arm equals 12.5

tons). A major drawback with this concept is sheer magnitude. Transportability, stowage, and deployment of a buoy at least 5 feet in diameter and long enough to attenuate the maximum waveheight would pose severe problems.

**Inflatable Ramp** (Fig. 12.24): In this concept an inflatable rubber ramp is suspended over the side of the ship. The vehicle is lowered and raised using the ramp as a guide and the ship's boom as support. Stowage and weight problems would be practically nonexistent. However, the idea may be too simplistic in that the configuration of the vehicle may not lend itself to be easily guided by a simple ramp. Vertical orientation may be difficult to maintain, and fragile exterior equipment would be prone to damage.

**Centerwell** (Fig. 12.25): Deployment and recovery through a hole in the ship near the

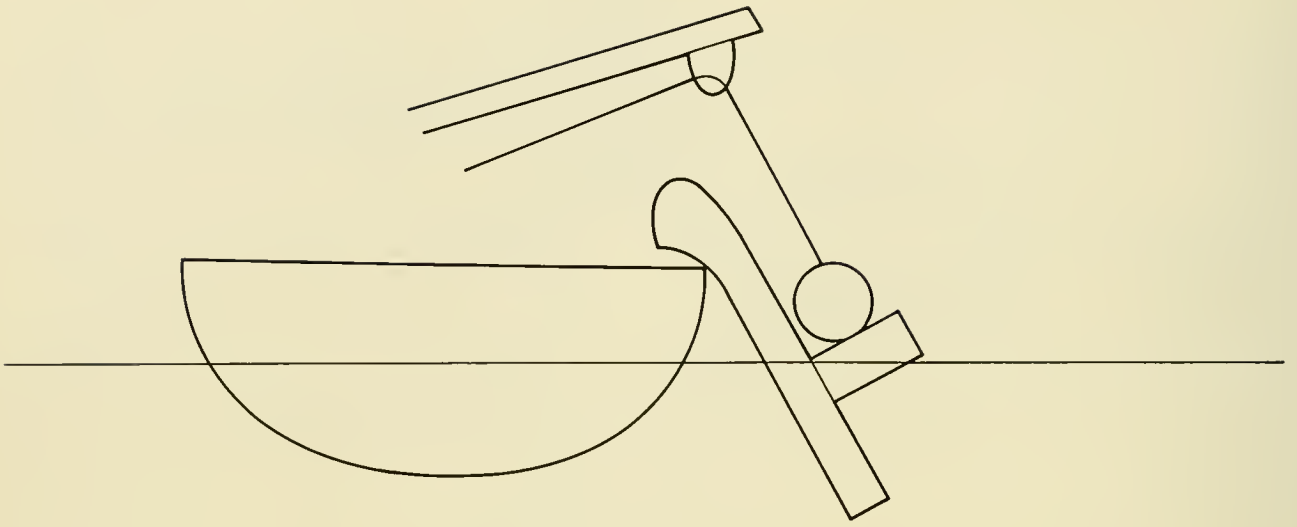

Fig. 12.24 Inflatable ramp.

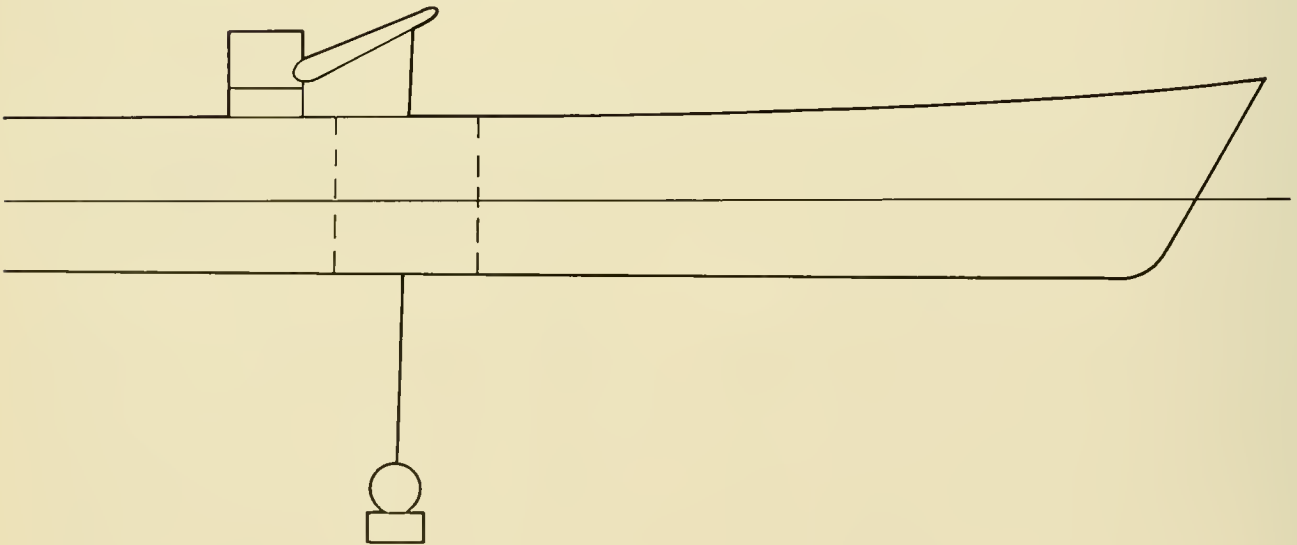

Fig. 12.25 Centerwell

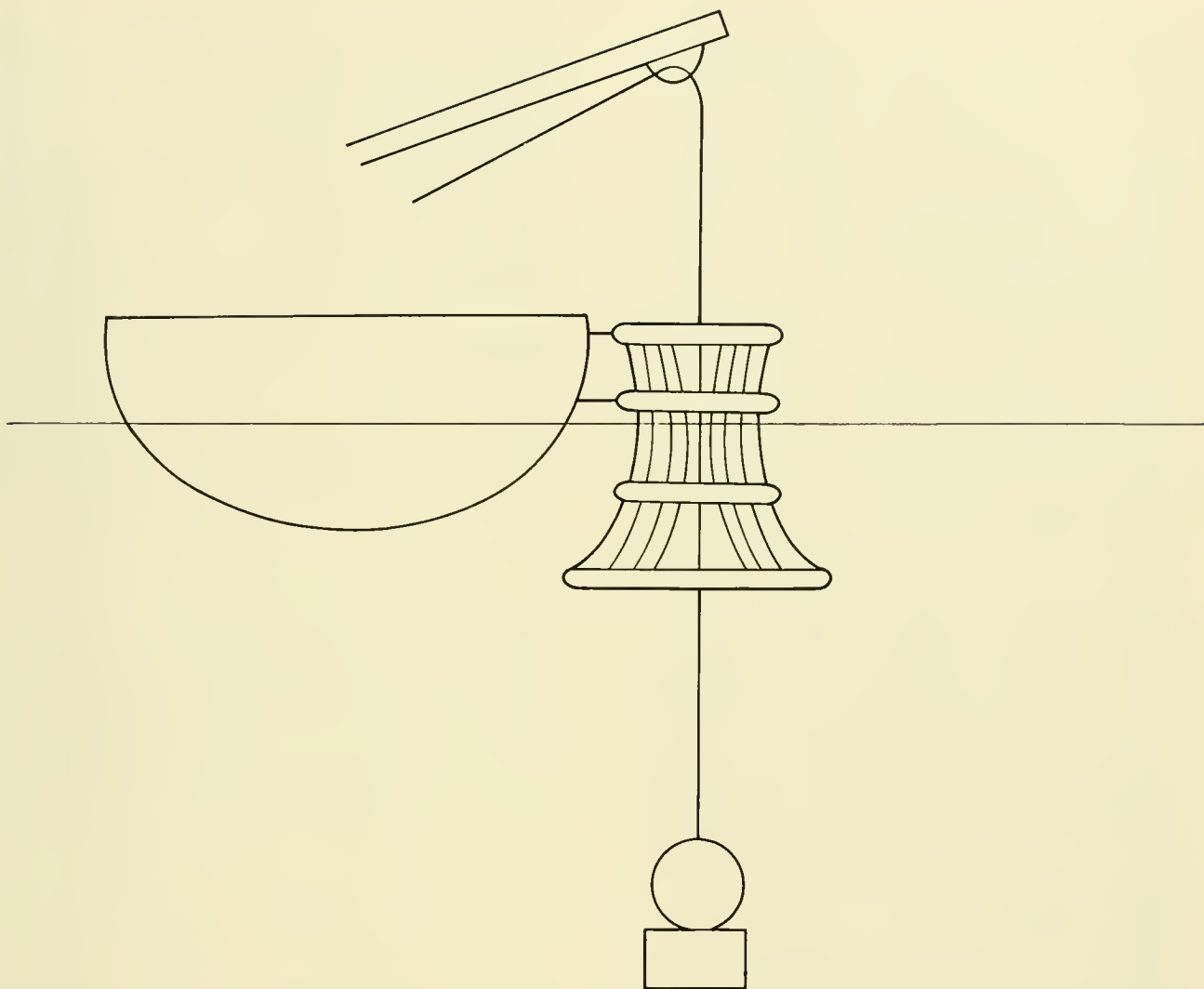

Fig. 12.26 Guiding chute.

intersection of the roll and pitch axes may greatly reduce undesired motion. However, this feature is rarely available on ships of opportunity.

**Guiding Chute** (Fig. 12.26): In this concept, a cage acting as a guiding chute is deployed over the side of the ship. The vehicle is raised and lowered through it using a series of guide shoes attached to the vehicle. Lift is provided by the ship's boom. The probability of dangerous impact loads between vehicle and cage as the vehicle is first drawn into the chute during recovery makes this concept unfeasible.

**Balloon Assist** (Fig. 12.27): The Balloon Assist is a variation on the "gradual change to ship-motion" theme. Recovery and deployment take place from a winch riding the tether of a relatively stable balloon towed by the ship. Once the PTC is pulled completely out of the water during recovery, the winch is wound down onto the ship and the PTC is secured. Major drawbacks are the possibilities of wind direction change, requirement of at least 315,000 SCF (in the case of the PTC) of helium for the balloon, and the balloon handling, maintenance, and manning problems.

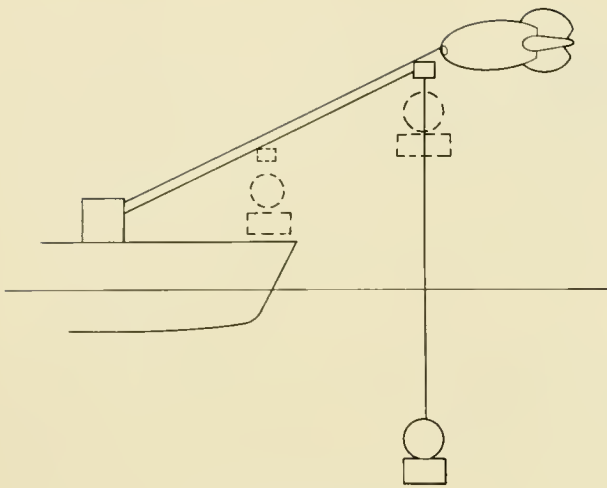

Fig. 12.27 Balloon assist.

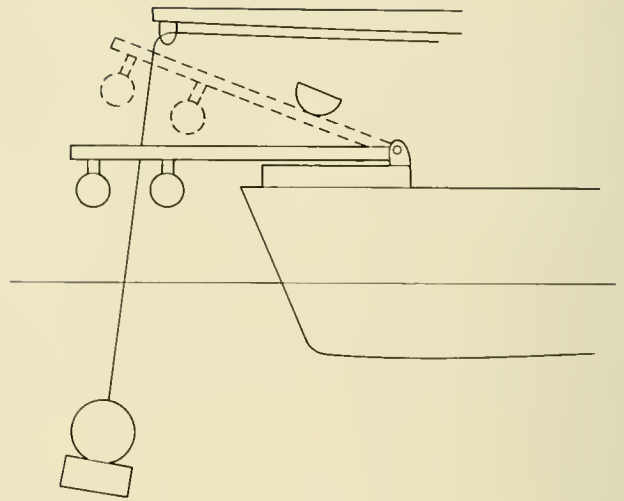

Fig. 12.28 Quick snatch.

**Quick Snatch** (Fig. 12.28): This concept employs a shock-absorbing collar such that the vehicle can be quickly removed from the sea. As the vehicle passes thru the air-sea interface it contacts the absorbing collar which is attached to an arm that moves upwards to a restraint. The pivot of the arm is set on a rotating table that allows the entire package to rotate the vehicle over a stowage point.

**Telescoping Cylinder** (Fig. 12.29): This concept employs a hydraulic cylinder with two modes of operation—normal push-pull power and damping, controlled by variable orifices. The lift cable leads through an attachment at the end of the cylinder that provides automatic latching. The cylinder is powered about its horizontal axis by a rotary actuator or gears, with the entire unit on a turntable.

Deployment commences by positioning the attachment on the cylinder end over the vehicle which is in a stowage position. Hookup is made and the vehicle is moved overboard and into the water. At some point below the surface the hookup is released and the vehicle is lowered. Recovery commences by pulling the lift-cable in until the vehicle latches onto the attachment device, at which time the cylinder is in its damping mode, preventing undesired ship motion from resulting in damaging dynamic loads. Once the vehicle is attached the cylinder is switched

to power mode and the vehicle is raised from the sea and set on deck.

The major problem with the dual-mode telescoping cylinder, in the case of the 10-ton PTC, is the bending stress induced when it is extended and carrying the weight of the

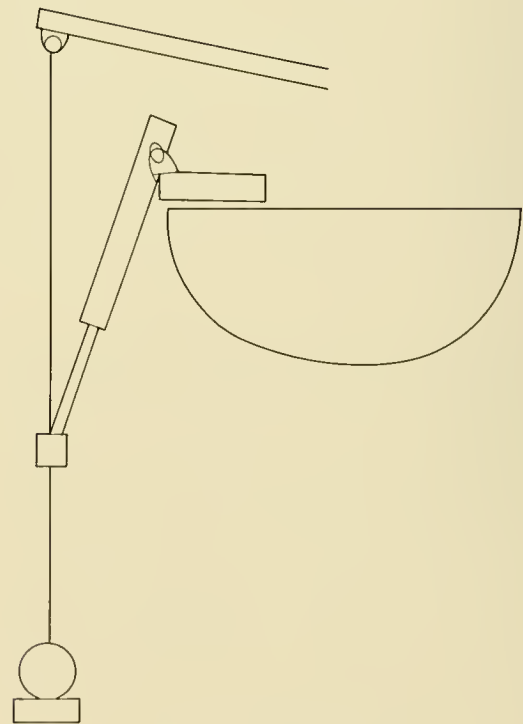

Fig. 12.29 Telescoping cylinder.

PTC. The moment arm would be at least 15 feet, which would mean bending moments of 15 feet  $\times$  20,000 pounds or 300,000 foot-pounds. Design of a cylinder to handle such loads would be difficult. This concept was considered unfeasible for the PTC.

**Rope-Net Catch** (Fig. 12.30): The simplest concept in which the principle of pulling the vehicle snug against a member fixed relative to the ship manifested itself in the rope-net catch concept. Two or three outriggers are used to lay a large rope net on the ocean surface. A strength cable is then threaded through the center of the net and used to pull the vehicle up. Once caught in the net, the weight of the outriggers keeps a taut downward pull on the vehicle and prevents undesired motion as the vehicle is removed from the sea. The strength cable is reeved through a sheave on the ship's boom.

The major problem with this concept is the inherent untidiness and unpredictability of the net. Also, fragile appendages on the vehicle could easily be damaged.

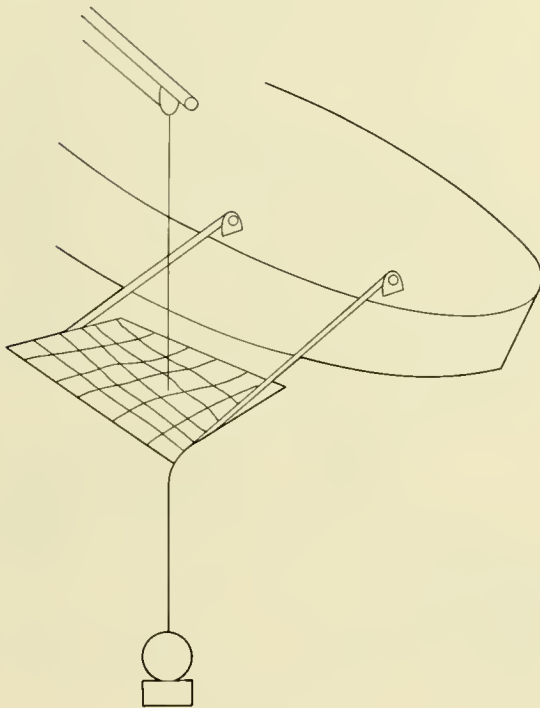

Fig 12.30 Rope net catch.

The foregoing delineates the wide variety of methods and concepts available to launch/retrieve a submersible at sea.

It would be tidy to say that system "X" is the best and therefore recommended over all others. But, as we have seen, the variety in submersible weights, dimensions and configurations is myriad, and what might work for one will not work for another. Doerschuk *et al.* found that no one concept was right for handling the PTC and they proceeded to take the most desirable features of several and combine them, as was feasible, into a suitable system. This procedure might well be the best solution to present and future handling problems. But no matter what the selection procedure is based upon, one should not expect an ultimate arrangement; because the sea has a whimsical personality and, as Usry concluded: "There will always be an element of danger when handling such loads at sea and no computer is going to suddenly reveal a shining solution free of compromises."

## LIFT HOOKS

Though seemingly a simple problem, the selection of lift hooks is of extreme importance and—as demonstrated by *DS-4000's* helicopter hook failure with pilot and crew aboard and a consequent 8-foot drop—it can be a critical choice. The proper selection calls for a hook that is quickly and easily attached for lifting and will not jump out of its restraint as the submersible is lifted or jerked about. For launching, the requirements are that it will not fail or release accidentally and can be quickly released when desired.

**Pelican Hook** (Fig. 12.31): This type of hook is in general use. It is cheap, rugged and quick to attach. Problems can arise, however, when the vehicle and support craft are in dissimilar motion, and it is sometimes quite difficult to obtain sufficient slack to hook up. Further, a diver is required to detach the hook, and, as the submersible is wet and slippery, the diver must hold on with one hand, detach the hook and then avoid its wild swinging until it is lifted clear. It can be a difficult proposition.

**U.S. Navy Safety Hook** (Fig. 12.32): This hook has been adapted for use by the *DEEP-STAR* series of submersibles. It has been tested to 44 tons and cannot be opened as

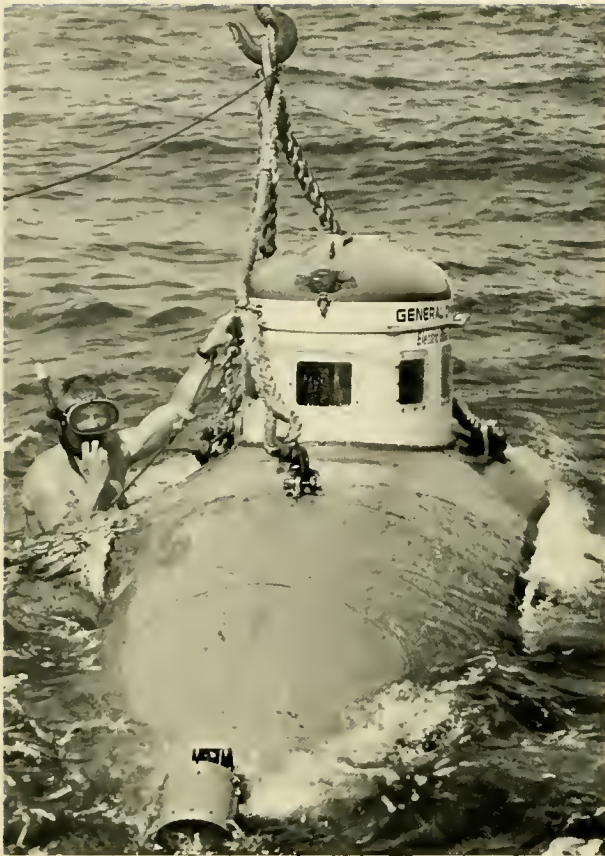

Fig. 12.31 A pelican hook on the lift bundle of *STAR III*. (NAVOCEANO)



Fig. 12.32 U.S. Navy safety hook. (NAVOCEANO)

long as 500 to 800 pounds of load are on the hook. It provides positive visual identification in the locked condition and a guide line is led by hand into the submersible's lifting ring, which is fairlead back to the ship for closure. During launch a release lanyard is triggered from the ship at an appropriate time, thereby negating the use of divers.

**The Link Hook** (Fig. 12.33): Built into the lifting structure of the *LINK*-designed submersibles (*DEEP DIVER*, *SEA LINK* and others) is a housing into which an inverted "T" shaped device, with a circular base, is inserted. The edge of the circular base is designed such that once the device is inserted and twisted it cannot be freed until twisted back to the original position, thereby avoiding inadvertent release. A further re-

finement built into the *JOHNSON SEA LINK* system is shown in Figure 12.34. The inverted "U" shaped arm termination fits over a device on the vehicle's topside and prohibits it from rotating in the horizontal plane once the submersible is snug against the boom.

## TOWING

Submersibles too large for at-sea launch/retrieval and not having access to an *LSD* for support, must be towed to distant dive sites. There are several disadvantages to towing: Towing speed is slow (5-6 knots maximum); working on the pitching topside of a submersible is difficult and, at times, dangerous (the Federal Civil Service regulations pro-



vide for hazardous duty pay when such work is performed during sea state 5 or greater); and work below the vehicle's waterline must be performed by divers which is dangerous as well as time consuming and cumbersome. In some instances external equipment installation can be performed in a sheltered anchorage and the submersible subsequently towed to the dive site. If the sea is rough a great deal of damage can be done to the instruments and their electrical connectors by wave slap during the tow. On the positive side, towing gets the submersible to the job.

## PERSONNEL AND SHORE FACILITIES

Predictably, the larger the submersible,

the greater the number of and more specialized the personnel required for its maintenance. In most instances the ship's crew bears a hand in launch and retrieval, although they may not be considered part of the submersible crew. Hence, it is difficult to precisely define the submersible's complement. When the submersible is brought ashore for overhaul or repair, a similar identification problem occurs when individuals with special talents are called in on a temporary or one-time basis. Consequently, the personnel support listed (Table 12.5) is less than minimal, but gives an appreciation of the overall support required.

The numbers and types of support personnel required ashore to take care of logistics, planning, documentation, certification or classification and a wide variety of other

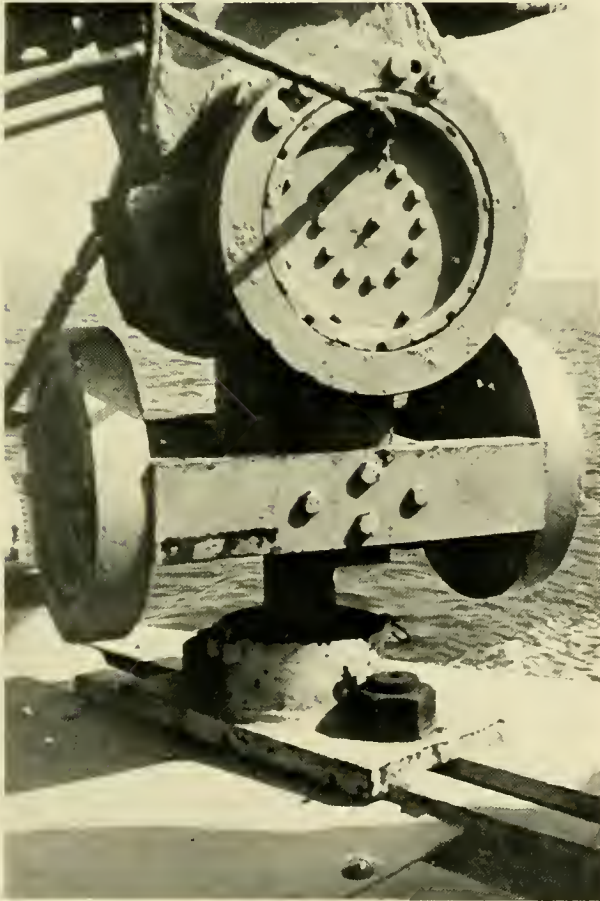

Fig. 12.33 A lifting hook (already inserted into the lift housing) designed by Mr. Edwn Link. (NAVOCEANO)

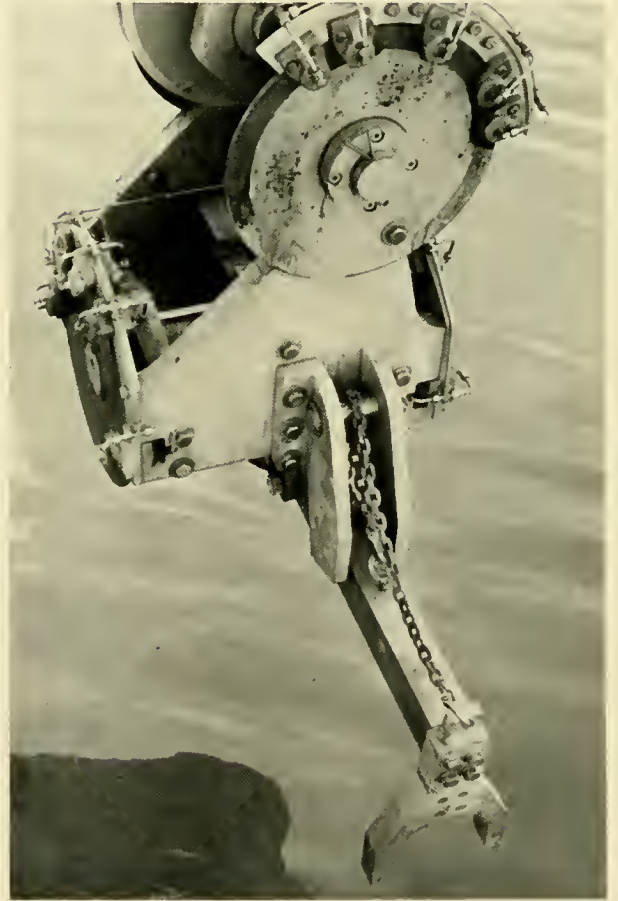

Fig 12.34 The "index" bar in the foreground serves to restrain *JOHNSON SEA LINK* from rotating in the horizontal plane

TABLE 12.5 PERSONNEL SUPPORT AT SEA

	Submersible's Crew	Support Ship's Crew
TECHDIVER (PC-3B)	(3) Operations Leader/Pilot Pilot Pilot/Tech	(3) Master 1st Mate Cook
STAR III	(4) Pilot/Diver Pilot/Maint. Eng/Diver Pilot/Elec. Tech/Diver Pilot	(7) Master Chief Engineer 1st Mate Seaman (2) Cook Cook's Helper
DEEPSTAR-4000	(12) Operations Leader Chief Pilot Pilots (2) Maintenance, Chief Electrician (3) Mechanic (3) Service Asst.	(7) Master Chief Engineer 1st Mate Seaman (2) Cook Cook's Helper
ALVIN	(11) Expedition Leader/Pilot Pilots (2) Crew Chief Mechanic Electrician Materials Tech. Instrument Supervisor Instr. Technician (2) Photographer Diver	(7) Master Chief Engineer Engineer Navigator Seaman Cook Steward
DEEP QUEST	(8) Operations Leader Chief Pilot Pilot Electrician (2) Electronics Eng. Hull & Life Support Eng. Hydraulics Eng.	(9) Master Engineer Cook Steward Ship Fitter Deck Hands/Technician (4)
TRIESTE II	(21) Officer in Charge Operators (Pilots) (3) Instr. Elec. Tech. (3) Elec. Tech. (3) Mach. Mates (4) Boatswain's Mate Storekeeper Yeoman Shipfitter Data Syst. Tech., Photographers Mate, Seaman	(100) WHITESANDS Complement: 4 officers; 96 enlisted men

day-to-day duties depend on the complexity of the vehicle and its support system. More or less typical of the mid-range vehicles is *ALVIN*, whose shore-based support personnel are: A Quality Control Engineer, Chief Draftsman, Draftsman, Secretary, Instrument Engineer, Mechanical Engineer, Engineering Technician and Structural Engineer.

The background of submersible operators or pilots and support personnel is varied. By and large, most pilots are ex-Navy personnel with submarine experience, but this is not a requirement; for example, of *DEEPSTAR 4000*'s four pilots, only one was an ex-submariner. Of the remaining three, one was a naval aviator, one a civilian draftsman with extensive scuba experience and one a civilian diver/photographer. On the other hand, *DEEP QUEST*'s submersible pilots and crew are almost solidly of Naval background.

Versatility is one aspect common to all backgrounds, for in many instances an engineer or pilot may be required variously, to: Don scuba tanks to inspect or help repair the submersible, handle a line during the launch/retrieval or bear a hand in loading supplies on the support ship or submersible. In essence, a member of a submersible's support crew must be specialist, generalist and ordinary seaman, and the smaller the submersible, the wider the range of individual duties. There can be no *prima donnas* in a submersible crew.

Facilities ashore to support the submersible range from garage-size to hangar-size. Within this range is a wide variety of capabilities with none individually being representative of the community in general.

Quite naturally, the more transportable (smaller) the submersible, the farther away from a dockyard or pier it may be. Submersibles of the *NEKTON* class are trailer-transported to their shop. Large submersibles, such as *DEEP QUEST*, are generally based on the water front where a marine railway is available to haul the vehicle to and from its shop.

A submersible as large and sophisticated as *DEEP QUEST* requires considerable shore-based support. The San Diego, Cal., shore base includes a 165-foot pier, marine railway (70-ton capacity), waterfront ramp area and a building housing offices, shops,

equipment and maintenance area. The latter includes electronics, electrical, hydraulic and diver equipment shops.

On the other hand, *SEA OTTER*'s home base is several blocks from the waterfront and consists of one large room (shop) and a small office.

The majority of submersible operations have been conducted in temperate and tropical latitudes. Only a few have taken place in the Arctic. The only problems unique to the tropics are the obvious ones of heat and humidity; for this reason an air conditioning unit is used to blow air into the pressure hull while the vehicle is being worked over aboard its mother ship. When operating on the surface or in shallow water the heat and humidity can become unduly oppressive in a very short time, for it is assisted by heat generated by electric equipment in the pressure sphere. Even so the tropics and subtropics are far more benevolent than are the high latitudes.

Arctic operations are controlled by weather, temperature and ice. Diving under an ice cover is risky business in a short-duration submersible with no accurate and reliable means of navigation and any number of potential failure areas. Hence, the majority of such dives proceed with a line attached to the vehicle to retrieve it in the event of a breakdown or navigation error. Obviously, the vehicle must be in a heated shelter aboard ship in order to perform routine maintenance.

Most cold weather problems with submersibles are predictable, but one that was not was the O-ring viewport seals on *DEEP DIVER* working in the Aleutian Islands in 1972. During each dive seawater would collect between the viewport and its metal insert and freeze when *DEEP DIVER* was retrieved; the O-ring would freeze solid on exposure to the air. When the submersible was placed back in the water the ice melted, but the O-ring remained contracted and inflexible. Consequently water leaked into the pressure hull between the viewport and its housing. This required retrieving the vehicle, removing each viewport and wiping the housing dry. Subsequently the neoprene O-rings were replaced with silicon O-rings which solved the problem.

Supporting and maintaining a submersible to dive on schedule is fraught with the potential for disappointment. The field of submersible operations is still new and experience-limited; hence, equipment failures and operational problems are inevitable. Even surface ships, with hundreds of years of experience, regularly encounter the unexpected and are forced to retire for repairs or devise a new approach. So, it must be expected that, with slightly more than a score of years' total experience, submersible operations will encounter the unpredictable for some time to come. Figure 12.35 provides an insight into some of the unpredictables with *PISCES III*; similar tables can be expected from virtually every other submersible operation.

## REFERENCES

1. Sly, P. C. 1971 *Submersible Operations in Georgian Bay and Lake Erie—1970*. Tech. Bull. No. 44, Inland Waters Branch, Dept. Energy, Mines and Resources, Ottawa, Canada, 36 pp.
2. Hirano, Y. 1972 *The Mother Ship of an Undersea Research Vehicle*. Preprints, 2nd International Ocean Dev. Conf., Tokyo, v. 1, p. 757-769.
3. Barringer, J. L. 1967 *CUBMARINE Operations in Spain*. Geo-Marine Tech., v. 3, n. 1, p. 12-18.
4. Bascom, C. W. 1970 *Small Submersible Support Systems*. ASME Pub. 69-Unt-5, 8 pp.
5. Doerschuk, D. C., Adkins, D. E. & Glasgow, J. S. 1970 *Mark I Deep Dive System (DDS-1) Handling Study Phase I—Conceptual Design*. Summary Rept. to Naval Ship Engineering Center, Contract No. N-0014-70C-0072.
6. Goudge, K. A. 1972 *Operational Experience With PISCES-Submersibles*. Conf. Papers Oceanology International 72, Brighton, England, p. 270-273.
7. Makai Range Inc. 1970 *A Method to Handle Small Submersibles at Sea*. Rept. to U.S. Naval Undersea Research and Development Center, Contract No. N00123-70-C-1842, 35 pp.
8. Estabrook, N. B. & Horn, H. M. 1972 *Stable platforms for the launch and recovery of submersibles*. 4th Ann. Offshore Tech. Conf., Houston, Texas, Paper No. OTC1624, p. 77-86.
9. McFarlane, J. R. & Trice, A. B. 1972 *Core Sampling in the Hudson Bay*. Preprint Offshore Tech. Conf., Houston, Texas 1972, Paper No. OTC1631, p. II-169-II-174.
10. Leiby, J. T. 1968 *Constant Tension Submersibles Handling System*. W.H.O.I., Ref. No. 68-34. (Unpub. Manuscript)

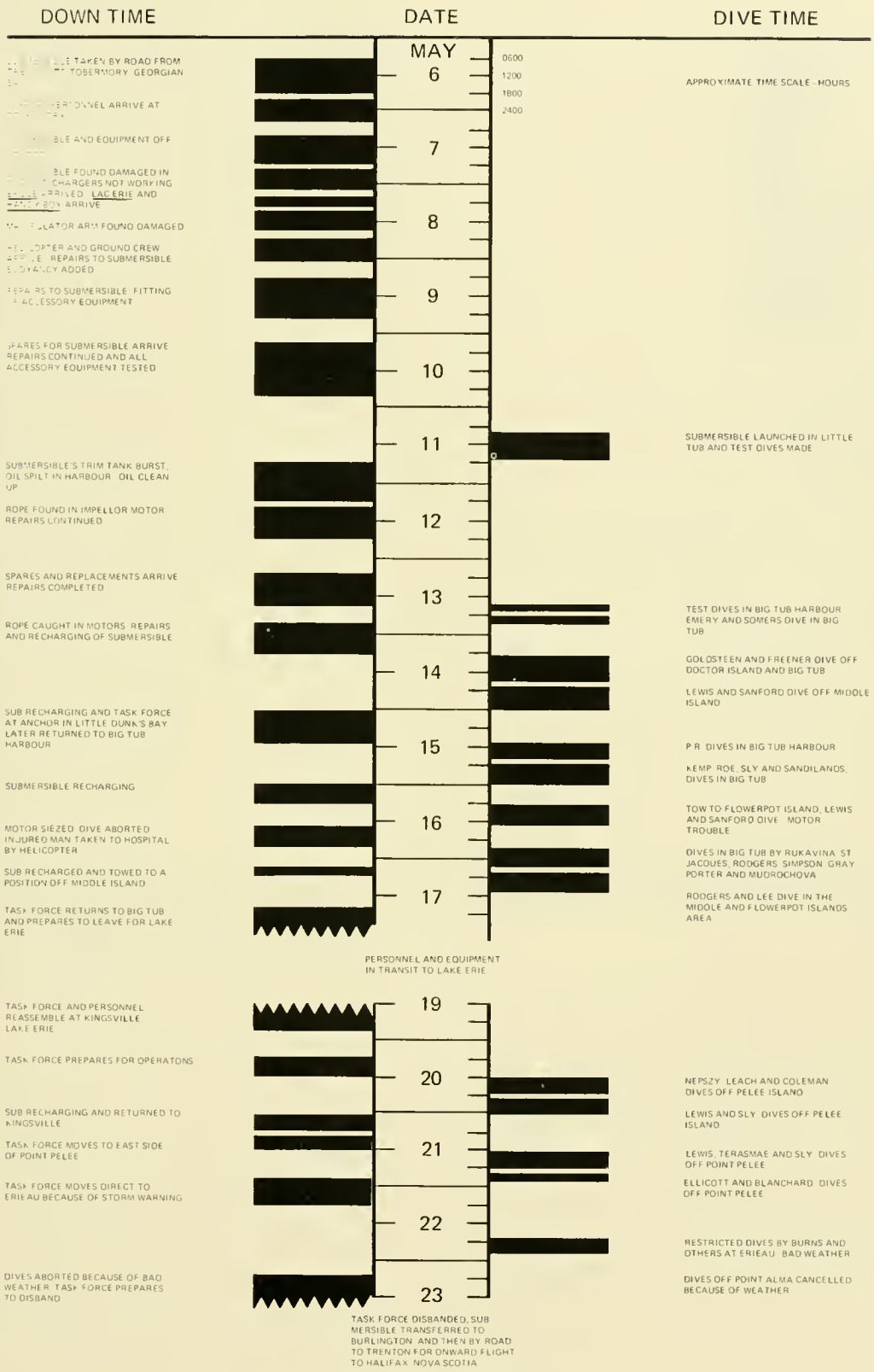

Fig. 12.35 Summary of PISCES III's Operations. [From Ref. (1)]





# 13

## CERTIFICATION, CLASSIFICATION, REQUIREMENTS

Depending upon their use, there are and there are not Federal legal requirements covering construction, materials or operating licensing in the U.S. for manned submersibles. Submersibles which carry passengers for transportation or recreational purposes fall into a category wherein Federal regulations are applicable. Prior to 1971 the Motor Boat Act of 1940 encompassed the only regulations for submersibles. In 1971 this act was rewritten and under its provisions passenger-carrying and recreational submersibles are covered. However, no submersibles now operating fall into a category wherein the "passengers" are defined under the Motor Boat Act of 1971; therefore vehicles carrying scientists and engineers have

only minimal legal requirements to fulfill. These, and others, are discussed more fully under U.S. Coast Guard Requirements later in this chapter. The U.S. Navy has its own certification procedures, established in 1967, for submersibles operating under their aegis with Navy personnel aboard.

For the civilian sector, in 1968 the American Bureau of Shipping, in response to a request made by the U.S. Navy and private industry, organized a Special Committee on Submersible Vehicles to deal with the preparation of regulations to govern commercial submersibles. Due to the limited commercial use and lack of ABS experience with submersibles, it was decided to publish a guide manual instead of a specific rule book. The

*Guide for the Classification of Manned Submersibles* covers various governmental regulations which owners, builders and designers must keep in mind for safe operation and licensing.

A number of attempts have been, and are being made, to establish legal requirements for the construction and operation of all submersibles. Table 13.1 lists these attempts, and a copy of the latest (HR 8837) is shown in Appendix II. In essence, these bills propose to regulate the design, construction and operation of the vehicle and the qualifications of the operator, as well as to rate the adequacy of schools offering instructions in vehicle operations. In all cases but one (S2145), the U.S. Coast Guard is designated as the regulatory body. The one exception would give that authority to the National Oceanic and Atmospheric Administration. Significantly, no bill has yet been enacted into law.

Before dealing with requirements of Navy certification or ABS classification, it would seem appropriate to outline the case for legal requirements. Private owners of submersibles in the United States look with some apprehension on proposed submersible safety legislation because they feel the "Bureaucrats" would subject their vehicles to expensive and restrictive requirements which would not only put them at a competitive disadvantage internationally, but would also stifle innovation. The proponents of legislation (Table 13.1) feel that some sort of safeguards, in addition to the builders' good intentions, should be a legal requirement to protect the passengers.

It would appear that both groups are correct. The cost of certification as carried out

under U.S. Navy regulations can be expensive if the procedures are initiated after the submersible is constructed and in service. On the other hand, costs would be least if the certifying procedures ran concurrently with design and construction. Mr. John Purcell of the U.S. Naval Ships System Command stated that anywhere between \$5,000 and \$25,000 can be required to fund the efforts of Navy's certifying of personnel on one vehicle, depending upon when the certifying procedure was started. This estimate does not include the cost of any physical efforts on the part of the owner, and, in all likelihood, the total cost of Navy's material certification will be on the high side of this range. On the other hand, without some safety governing organization, the scientific and engineering passengers in submersibles, who are largely ignorant of submersible construction or operation, must place complete faith in the capabilities of the designer, the builder and the operator.

If we look at the present situation, however, it further appears that the submersible industry is doing a good job of policing itself despite the lack of any legal requirement to do so.

A list of ABS-classified submersibles is presented in Table 13.2. Accompanying these are submersibles which have applied for classification, but, for reasons unconnected with their design, have not yet received such. All presently operating Navy submersibles (*ALVIN*, *DSRV-1 & 2*, *SEA CLIFF*, *TURTLE*, *TRIESTE II*) and inactive Navy submersibles (*NEMO*, *MAKAKAI*, *DEEP VIEW*) have undergone Navy certification. The vehicles which are not included in either category are

TABLE 13.1 PROPOSED SUBMERSIBLE LEGISLATION

Sponsor	Bill	Date Introduced	Congress	Title
Congr. Rogers	HR 16286	1968	90th	Manned Submersible Safety Act
	HR 11282	1969	91st	" " " "
Congr. Lennon	HR 15711	1968	90th	Submersible Vessel Safety Act
	HR 246	1969	91st	" " " "
	HR 2484	1970	91st	" " " "
Congr. Downing	HR 8837	1973	93rd	Submersible Vessel Safety Act
	HR 8924	(A reissue of HR 8837)		
Sen. Hollings	S 2145	1973	93rd	Civilian Oceanographic Research Facilities Act of 1973
U.S. Coast Guard	OMB 93-48	Not yet introduced (Nov. 1973)		



TABLE 13.2 SUBMERSIBLES CLASSIFIED BY THE AMERICAN BUREAU OF SHIPPING

Classified	Submitted for Classification	
AQUARIUS I	PC-1201	AUGUSTE PICCARD
BEAVER	PC-1202	DEEP QUEST
BEN FRANKLIN	PC-1401	DEEP STAR 20,000
DEEPSTAR 2000	PC-1402	SEA OTTER
GUPPY	PISCES I, II, III, IV, V, VII, VIII, X	SEA RANGER 450
JOHNSON SEA LINK I	PS-2	PC-1203
K-250 (VAST MK II)	SDL-1	PC-1204
NEKTON (BETA & GAMMA)	SHELF DIVER	PC-16
OPSUB	TS-1 (PC-9)	PISCES VI
PC-8B	VOL- L1	

vehicles which do not ordinarily seek to carry occupants other than the operator(s). In short, charterers of submersible services can choose from a wide list of vehicles either ABS-classified or Navy-certified.

At this point we shall leave the Naval submersibles, which by Navy policy must undergo and pass certification to operate, and will deal with privately-owned vehicles. In particular, let us address the question of why's and the benefits to owners and builders of ABS classification.

Commander C. B. Glass, USCG, in a 1969 paper (1) described the U.S. Coast Guard's position on legal requirements for submersibles (pro) and pointed out that industry owners themselves (Refs. 2 and 3) saw the following benefits from certification:

1. Reduction of insurance expenses.
2. Establishment of confidence/acceptance by the customer.
3. Safety from an irresponsible few who might endanger the economic and scientific growth of submersible activity.

Personal communications with Dr. J. W. Vernon, General Oceanographic Inc.; Mr. D. Barnett, Perry Submarine Builders, Inc. and Mr. M. Thompson, International Hydrodynamics, Ltd., who collectively have built and operated 20 manned submersibles, reveal that there is no apparent reduction in insurance policies after the vehicle has undergone ABS classification. The only conceivable advantage, according to Dr. Vernon, is that it (ABS Classification) might influence an insurance company to decide whether or not they will cover the vehicle. This opinion is shared by Mr. Barnett who further states

that, in his opinion, the insurance companies have had insufficient experience in submersible insuring and do not distinguish between a classed or unclassified vehicle as far as the size of the premium is concerned.

A benefit can be seen in classification regarding establishing confidence and acceptance on the customer's part. Mr. Barnett states that adherence to ABS classification demonstrates that the vehicle is "built to a standard" established by recognized authorities in the field, and not merely those of the builder. In the past several years ABS classification has become a requirement of several non-military American Federal Agencies. The submersible owner who wishes to lease his vehicle to these agencies must produce the required ABS documents, a benefit of classification not mentioned by Commander Glass.

ABS classification standards were drawn up by representatives from the Navy, Coast Guard, industry and academia. Commander Glass states that except in special cases, the Coast Guard now accepts—though not necessarily "rubber-stamps"—ABS classification of surface vessels as proof of the adequacy of structural design and expects that a similar relationship will develop with submersibles. One is therefore led to speculate why laws are required, when the vast majority of vehicle owners and users have voluntarily adopted ABS classification as a prerequisite to utilization.

Regarding the benefit of safeguarding against ". . . an irresponsible few," it is sufficient to note that since the operation of Auguste Piccard's *FNRS-2* in 1948, over 100

submersibles have been built throughout the world and have conducted thousands of dives carrying over 30,000 people. In this 25-year period there have been four fatalities in submersibles themselves and one submersible-related fatality. It would seem that irresponsibility is not a characteristic of this un-governed industry.

## POTENTIAL HAZARDS

*“If everything has been done in advance, and no one makes a fool of himself, or forgets, a submarine is the safest kind of boat to be in.”*

—Simon Lake

Albeit a submarine is a safe boat to be in, but Mr. Lake did not envision that it would be lifted out of the water after each dive and carry an agglomeration of equipment while it poked its way into narrow canyons or amongst a tangle of debris. Because it is a component of a system, the submersible's occupants are as dependent upon a safe launch/retrieval system as they are upon a safe vehicle.

There are two general areas wherein potential hazards exist; 1) the submersible system, and 2) the environment in which it operates. These two areas are grouped under System Hazards and Environmental Hazards, and the potentials for failure are discussed below.

### System Hazards

Within this category fall Materials and Sub-Systems, Instruments, Operators and Launch/Retrieval Systems. Many of the potential hazards which may befall the submersibles' occupants are obvious; some are not, and the possibility of more than one occurring during the same dive is always present and has occurred. The groupings below are not presented in order of priority, because, at the risk of being repetitious, the submersible is part of a system and that system, like the proverbial chain, is only as strong as its weakest link.

### Material and Sub-System Failures

**Pressure Hull:** Failure of the pressure hull may occur within the vehicle's operating

depth due to a design fault, incorrect material selection or errors during fabrication procedures.

**Penetrations:** Thru-hull penetrations are additional areas where failure may occur. Electrical penetrations are liable to overload conditions which may completely burn away the thru-hull conductor and open a conduit through which water may enter the hull (Fig. 13.1). Conversely, in a lock-out vehicle, the sudden pressure drop created by the loss of the conductor may be detrimental to the occupants if they are decompressing at higher-than-ambient pressures.

**Emergency Deballasting:** All submersibles have some means of reducing weight in order to surface when the normal procedures malfunction and the possibility exists that these emergency systems may also malfunction.

**Entanglement:** Various vehicle appurtenances, e.g., skids, motors, ballast tanks, may protrude or be designed in such a fashion that they are liable to entanglement in cables or ropes (Fig. 13.2).

**Life Support Systems:** Failure of a life support system and its emergency backup system can occur during a dive leaving insufficient time to surface or, if unable to ascend, to

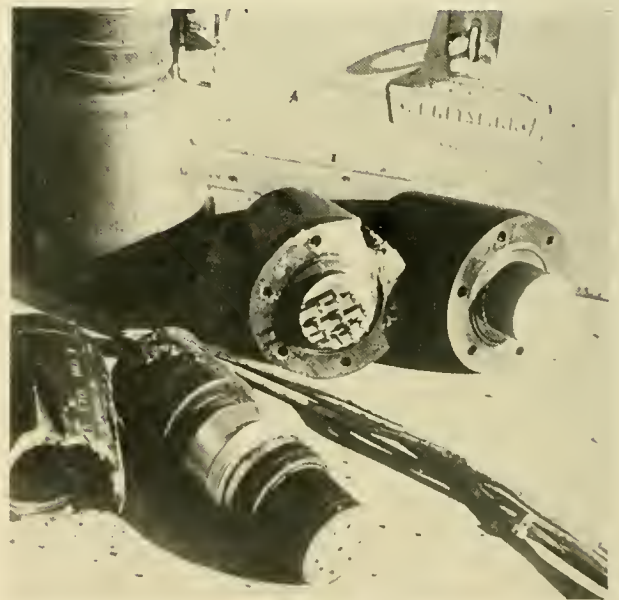

Fig. 13.1 A short circuit produced these burned penetrator housings on ALUMINAUT (NAVOCEANO)

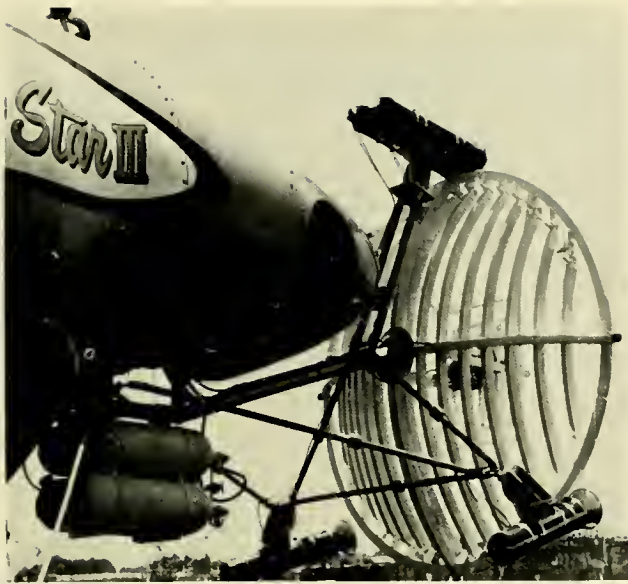

Fig 13.2 A "snaggable," but jettisonable acoustic array on STAR III. (Gen. Dyn./Elec. Boat)

support the occupants until help arrives. In another vein, the devices used to monitor oxygen and carbon dioxide may be faulty and lead to incorrect decisions regarding internal atmosphere or the remaining life support duration.

**Fire:** The interior cabling of a submersible may short circuit or overheat to a point where combustion may occur and endanger the occupants by burning or by evolution of noxious gasses or fumes.

**Propulsion:** Where a vehicle's mission may require it to travel under ice, overhanging ledges or under man-made structures, failure of the propulsion motors may make emergency deballasting procedures impractical.

### Instrument Failures

Within this group are failure or emergency potentials created by the physical presence of instruments external to the hull, and by the failure of the instrument to operate. In the first case are:

**Entanglement:** Instruments external to the hull fairings are subject to entanglement with ropes or cables.

**Implosion:** Pressure-resistant instrument housings may implode and create a shock wave which renders inoperative other systems critical to the vehicle's safety.

In the second instance are instrument failures which may render continued operations hazardous; these are:

**Depth Gages:** The failure or inaccuracy of depth gages may lead the operator to descend below safe limits.

**Obstacle Avoidance Sonar:** This sonar is used to warn the operator of distant (up to 1,500 yd) obstacles. Failure of this sonar essentially blinds the operator in limited visibility situations.

**Underwater Telephone:** Failure of the underwater telephone opens the possibility of surfacing into or in the path of surface traffic and, in a situation where the vehicle is unable to surface, renders surface support virtually helpless to respond.

**Tracking Equipment:** Loss of the submersible's position relative to the surface ship may result in the vehicle surfacing some miles from its support ship and essentially becoming adrift with slight chance of being visually located, and, because of its low superstructure, becoming susceptible to collision with oncoming surface crafts.

**Corrosive/Radioactive Materials:** Certain instruments utilize radioactive materials (e.g., sediment probes) or corrosive liquids (battery electrolytes) which, if freed, could be harmful to both personnel and vehicle.

### Operator Failures

The operation of a submersible ranges from simple to extremely complex, and the training, knowledge and duties of the operators increase proportionally. On a vehicle of the *DEEP QUEST* variety, the pre-dive responsibilities of the operator commence several hours before the actual dive. Into this scenario are introduced different missions and equipments for each dive, and the need for the operator to function in concert with the support ship's Master during launch/retrieval.

The operator must have a knowledge of every aspect of the vehicle's construction, operation and handling capabilities, as well as emergency procedures and instrument operations. The operator's panel on *DEEP*

**QUEST** (Fig. 13.3) or the **DSRV's**, for example, is as complex as that of a commercial airliner, and the wide range of potential hazards is equal in every respect to that facing aircraft pilots.

The potential for failures which the operator may cause are legion, but they may be attributed to one of several causes: Sickness, inexperience, forgetfulness or error in judgement. The first two can be controlled by medical examinations and a rigorous training/testing program, respectively. The third and fourth problems, forgetfulness and judgement errors, can be controlled to some degree by pre-dive check-lists and surface advice, but in the final analysis it is con-

trolled by the operator himself. Fortunately, the passengers' desire for an operationally routine dive is matched by that of the operator—as fail safe a system as is humanly possible.

#### **Launch/Retrieval Failures**

The systems used to launch and retrieve submersibles are subject not only to electrical and mechanical failures, turbulent surface conditions may also cause situations wherein the system may be operational, but unsafe, owing to the erratic differential motion between the submersible and its support ship (Fig. 13.4).

**Cables:** The results of a cable or boom breaking during launch or retrieval are fairly ob-



Fig. 13.3 Control console of *DEEP QUEST*. (LMSC)



Fig. 13.4 In moderate seas the close quarters between LULU's pontoons make line-handling and control of ALVIN an exacting task. (NAVOCEANO)

vious and may cause damage to the vehicle, the occupants and the support ship as well.

**Hydraulics:** The most vulnerable moment during launch/retrieval is when the submersible is free of the deck or water and suspended between the two. If, for example, the hydraulically-powered lift system were to experience a failure which made it incapable of lateral or vertical movement, and the sea were running high, the pendulum motion of the vehicle could be sufficient to cause great damage to participants and components.

**Collision:** Present submersibles come within a few feet of the support ship for attachment of the lift device; at this point the danger of collision, with its attendant damage, is crucial.

**Line-Entanglement** In addition to the main lifting cable, from two to six lighter restraining lines may be used to steady the submersible. Personnel entanglement with such lines is a possibility which may cause injury from the line itself, or temporarily immobilize the crew member, thereby putting him in a position of considerable jeopardy if the vehicle is plunging or swinging.

**Divers** Virtually all submersibles use divers or swimmers to attach or detach lift and steadying lines. Working between the submersible and ship, which may at times be separated by only a few feet, the swimmer is exposed to getting caught and crushed between both (Fig. 13.5). In addition, he is

liable to entanglement in the lines he is responsible for clearing.

### **Environmental Hazards**

Within this category are hazards external to the submersible. These hazards include: 1)

Natural Hazards (weather, currents, bottom sediment, topography, visibility, and organisms), and 2) Man-Made Hazards (cables, wrecks, bottom hardware and buoyed arrays, surface traffic, subsurface traffic and explosive ordnance). A more detailed account of



Fig 13.5 Divers attaching a salvage line to ALUMINAUT's bow. The hull of its support ship is in the background. (Robert Dill, NOAA)

environmental hazards and how they affect submersible operations is presented in reference (4).

### Natural Hazards

**Weather:** The effects of weather on sea state and its influence on launch/retrieval are discussed in Chapter 12. A further problem arises when waves higher than 4 or 5 feet make visual sighting of submersibles extremely difficult owing to their low silhouette. Although radio contact can be made, homing on submersibles is accomplished visibly and, in some instances, as much as 3 to 4 miles may separate support ship and submersible. This condition makes visible sighting of a low silhouette vehicle almost impossible. Deterioration of weather during the dive may affect not only the subsequent retrieval of the submersible, but the transfer of personnel to the support craft.

**Currents:** While the major ocean surface currents are generally known and their positions charted, little data exist concerning near-bottom currents where the submersible may be required to operate. Near-bottom currents are variable in both direction and speed over short periods of time, and they are strongly affected by topography. Short-term shifts in current speed and direction are common and have caused severe operational problems in an area where less than 0.1 knot was observed at commencement of a survey and over 3 knots were present at its termination (5). Control of the low speed submersible is almost impossible under such conditions, and the problem of avoiding man-made or natural hazards is magnified substantially.

Where extensive shallow water or enclosed areas are situated adjacent to a deep ocean area, a current may be generated by the differences in water densities between shallow and deep areas.

An example is the Strait of Gibraltar where water of greater density than contiguous Atlantic waters exits the strait due west along the bottom and then descends to a depth of over 3,000 feet where it spreads along areas of equal density. The danger of such a current is particularly significant to the low-speed, shallow-diving submersible which may get caught in the current and be

carried to areas in excess of its collapse depth before remedial action can be taken.

**Sediments:** The likelihood of being inundated by a turbidity current created by natural causes is probably very slight. The prospect however, of a submersible causing a turbidity current or sediment slide is possible and, in fact, has occurred.

During a dive into Toulon Canyon in the *FNRS-3*, the vehicle apparently broke a block of mud loose causing a mud slide or turbidity current (6). A sediment cloud was generated which reduced visibility to zero. In an effort to clear the sediment cloud, *FNRS-3* steered across the canyon on a descending course and ran into the opposite wall at a depth of 5,250 feet. After more than an hour's wait, the sediment cloud caused by impact with the opposite wall had not cleared; the vehicle began ascent and finally, at a height of 800 feet above the bottom, visibility returned.

An additional hazard would occur if the slide or avalanche weakened the formation above the vehicle. Under these conditions it is conceivable that a sufficient quantity of sediment can settle on a small submersible to prohibit the vehicle from ascending. In this regard, a submersible may collect mud through openings in the exostructure and keel—a more likely, but less obvious, means of accidentally gaining large mud weight. *ALUMINAUT* picked up 4,000 pounds of mud in its keel tanks when it inadvertently slid down a slope during an H-bomb recovery mission off Palomares, Spain, in 1966 (7).

**Topography:** Knowledge of ledges, overhangs and sheer walls observed in some areas of the ocean is of utmost importance to the submersible operator, who is generally restricted to limited visibility and little or no upward viewing capability. Though the submersible operator may operate with caution, even the most competent pilot can find himself in an unfavorable position.

During operations in the La Jolla Canyon, *DIVING SAUCER* entered an area of the canyon where the upper walls began to overhang and the distance between the walls became progressively less. Finally, the canyon narrowed to such an extent that the vehicle could not ascend due to the overhang

and it could not progress further upslope due to canyon narrowing. Owing to its high degree of maneuverability, the **DIVING SAUCER** was able to extricate itself from this situation; however, many of the less maneuverable submersibles might have been trapped.

Such topographic extremes can produce acoustic shadows which interfere with any acoustic link between submersible and support craft. **DEEPSTAR 4000** had occasion to enter a submarine canyon in the Gulf of Maine where the walls were so steep that signals from its pinger could not be heard on the surface. Consequently, tracking could not be maintained, and the dive was aborted.

**Visibility:** The lack of long range visibility and the limited number of viewing ports can bring the submersible into contact with all of the hazards mentioned heretofore. In tropic and sub-tropic waters, beyond the influence of terrestrial run-off, long range horizontal visibility exceeding 200 feet is possible. This is an optimum condition, however, and is not common. Beyond the limits of ambient light, 30 to 50 feet of lateral viewing with artificial light is average.

Even at a speed as low as 1 knot, only 30 seconds are available at 50-foot viewing range to detect, identify and respond to bring the vehicle to a halt.

**Organisms:** It is impossible to evaluate the over-all reaction of marine organisms to our invasion of their domain and to identify all those forms which represent some degree of hazard.

Over the past 50 years military submarines have logged countless hours in every body of water on this planet without encountering any significant threat from marine life. However, due to the difference in size and depth range, this experience cannot be related directly to submersibles. A good example is an attack made on **ALVIN** in 1,800 feet of water by a 250-pound swordfish without any obvious or intentional provocation on the part of **ALVIN**. The swordfish's bill wedged in the fiberglass superstructure of **ALVIN** on the first charge (Fig. 13.6) thus preventing him from pursuing his attack.

No damage was done to **ALVIN**, and later everyone enjoyed a swordfish dinner. But, it is possible that electrical wires or oil lines

could have been severed thus creating serious problems. A port could have been damaged through impact from a head-on encounter. Whether this was a "maverick" reaction or a characteristic reaction to small submersibles is not known. **BEN FRANKLIN** also experienced a swordfish attack during its Gulf Stream Drift Mission, but with less dramatic results.

A passive but no less potentially dangerous form of marine life, is the giant kelp. It is quite possible that a submersible penetrating a kelp "forest" could become so entangled that return to the surface would be impossible. This threat is compounded by reduced visibility caused by heavy growth.

When swimmers are used to support launch/retrieval, the threat from dangerous marine animals is compounded. Some of these threats are obvious in the case of sharks, but less obvious where Sea Wasps or other stinging coelenterates are concerned.

**Miscellaneous:** During operation on the Blake Plateau in 2,500 feet of water **ALUMINAUT** was traveling at 5 feet above the bottom and approached a large hole. Over this hole the vehicle descended although the 100-pound negative buoyancy had not been modified by the pilot. At least 1,000 pounds of steel shot had to be dropped before **ALUMINAUT** could stop its descent. Since no bottom current, which could have pulled the vehicle into the hole, was evident, the cause of descent was ascribed to fresh ground water seepage out of the hole which created a less dense water patch within the cavity. Although this is supposition by the crew, the fact remains that **ALUMINAUT** did descend, and marine fresh water aquifers are known to exit under the ocean along parts of the Atlantic coast. How widespread and prevalent such subaqueous aquifers may be is a matter of conjecture. A similar buoyancy change was said to have occurred when **ALUMINAUT** traversed the mouth of a large river off Connecticut.

### Man-Made Hazards

**Cables:** Submarine cables represent a danger of entanglement to the submersible. While the cable's route may be known, its configuration on the bottom can be in snarls or it may be suspended off the bottom as it



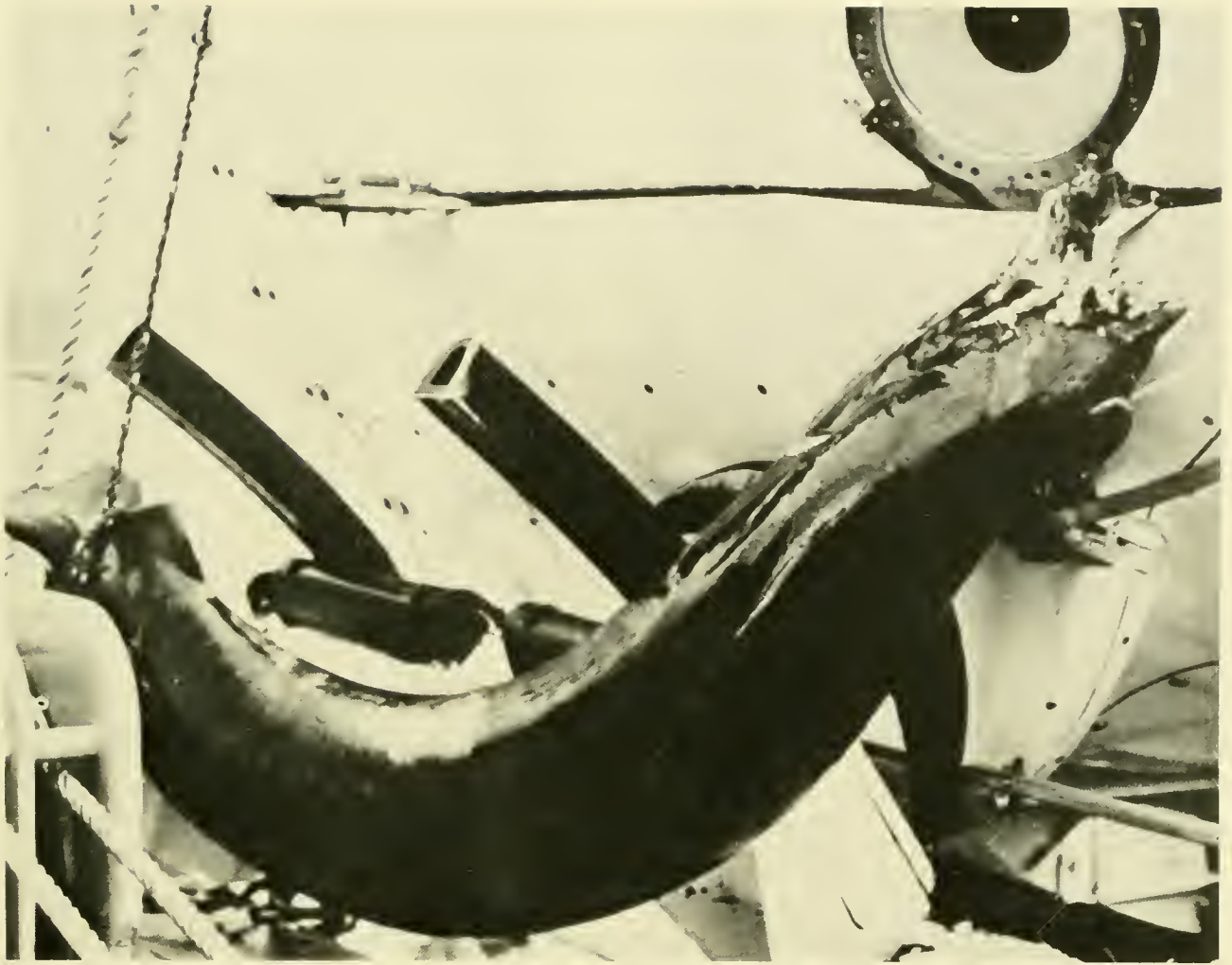

Fig. 13.6 A 250-lb swordfish impaled below ALVIN's viewport (WHOI)

passes over cliffs or depressions. Most cables are dark and may or may not provide contrast with their background. In some cases they lay buried beneath the bottom or may be covered with a thin veneer of sediment. In the above situations a submersible is open to snagging the cable with its superstructure, other appendages or its skids.

A dangerous situation is created by discarded or lost cables which may be present anywhere in the ocean and in any configuration (Fig. 13.7). Cables laid for power, communication or data transfer purposes are reported to cognizant authorities and their location is generally known. In the case of military cables, this may not always be true. There are no requirements for reporting or recording discarded or lost cables.

**Wrecks:** The possibility of fouling in rigging or appendages is the main hazard involving wrecks. Because viewing capability is limited in present submersibles, an operator may unwittingly cruise under a boom, spar, or rigging. Corrosion or boring organisms may have so weakened some appendages that the slightest pressure could bring a section of the wreckage down on top of the submersible or wrap a cable or line around its propellers.

If a wreck is on a steep slope or resting uneasily on the bottom, a slight nudge may cause it to shift in a manner jeopardizing the submersible.

Some wrecks may lie in depths where truly watertight compartments, containers, air bottles, boilers, and the like are near their collapse point. It is conceivable that a dis-



Fig 13.7 A tangle of cable at 5,500 feet in the Bahamas as seen from ALVIN

turbance of the wreckage could cause them to implode with consequent serious damage to a submersible in the vicinity.

**Bottom Hardware and Buoyed Arrays:** Bottom hardware may consist of military tracking devices, oil pipelines and completion systems, and a host of scientific equipment. Similar to cables and wrecks, they present another form of potential entanglement. Most bottom hardware has one thing in common: cables generally lead from them to shore or surface terminals. Some of this hardware is very heavy and may have moved downslope following implantment. This can result in the attendant cable being stretched taut from

the equipment and suspended several feet off the bottom so that the bottom-crawling submersible may pass under the cable. The array itself may have several appendages protruding outward which can snare the submersible. These appendages may be many feet off the bottom and not visible to the operator when bottomed.

The most hazardous aspect of all arrays, moors and similar hardware may result from the method used to install them. In many cases additional lines are used to lower the device and are left on it for subsequent retrieval. The result is an undisclosed and generally unknown number of lines or cables

lying at the base or hanging from various portions of the array. Rigging and handling lines may part under heavy strain resulting in a large ball of loops, snarls, etc. These lines, which are generally not shown in the array or buoy schematic, can be more hazardous than the hardware itself.

**Surface Traffic:** The primary danger to the submersible from surface traffic is the possibility of surfacing under or in the path of transiting vessels, and, to a lesser degree, being snagged by a fishing vessel. Most submersibles lack the control and the sensors necessary to stop ascent and assure that no surface traffic is present. Although the submersible's support ship may be displaying the proper signals to denote subsurface operations, commercial or pleasure craft may and often do ignore them.

**Subsurface Traffic:** The possibility of collision with a fleet-type submarine in the open sea is small. There are, however, areas of the ocean clearly marked on navigation charts as submarine transiting lanes. In some instances clearance to operate in these lanes and various ranges can be obtained by prior arrangement and appropriate charts along with supporting data may be available prior to an operation. Although the operator is under no legal requirements to coordinate his efforts with the Navy, to ignore such lanes and operating areas can place the submersible in danger of collision.

**Explosive Ordnance:** Millions of tons of explosive ordnance have accumulated on the floor of the world's oceans and seas, particularly over the last century. Explosive projectiles, sea mines, torpedoes, depth charges and bombs, hedgehogs and aerial bombs represent a threat to submersibles. Some may detonate only by contact, but others may be detonated magnetically or by pressure changes. The submersible operator will obviously avoid ammunition dumping sites, but an inestimable amount of ordnance litters the ocean floor at all depths and in all locations. The nature of this hazard is discussed in detail in reference (4). The explosive threat is not the only aspect of such ordnance; moored mines have employed mooring cables ranging in length from less than 100 feet to 5,000 feet. The cable is small in

diameter and is connected to an anchor which, depending upon the mine, may range in weight from about 300 pounds to 1,500 pounds (in air) and is connected at the other end to a mine case which may range in weight from 50 pounds to 1,000 pounds (in air). Snagging or becoming entangled in this cable could represent a serious hazard. In some areas the density of these cables and anchors is quite high. For instance, in the zone running between the Orkney Islands and the coast of Norway some 71,000 cables and anchors litter the bottom.

**Miscellaneous:** The effects of radioactive wastes and corrosive chemicals on a submersible may not be immediate, but the long term effects of investigating such dumping grounds could be hazardous, not only to the vehicle itself, but to the surface support crew as well.

Abandoned, lost and discarded junk of all descriptions litters the sea floor, especially in areas of high surface traffic. In most cases, information is unattainable concerning such debris and the pilot is left to his own discretion. Little can be said concerning where discarded hardware, cables, and lines will be encountered except that historically high density ship traffic areas are the most likely areas. Harbors, roadsteads and channels—contrary to rules and regulations—are generally littered with all types of debris. Limited visibility generally prevails in such areas, and the practice of making shallow test dives in a harbor while the surface ship is conveniently tied up may lead to unforeseen consequences. Fortunately, these areas are generally shallow and therefore permit diver assistance in the event of an emergency.

From the foregoing list of potential hazards, it would appear that diving is a dangerous pastime; it is. In spite of the cute names given to some vehicles, there is nothing cute about cold, pressure, asphyxiation or drowning, and the high safety record in submersibles reflects the fact that serious, contemplative consideration of such hazards has preceded the thousands of successful dives. Such consideration follows two fundamental planes: Preventing the emergency, and responding to it. Certification and classification are the frontline defenders for prevention.

Prevention of emergencies commences with the design stage of the submersible system and continues throughout construction and fabrication by virtue of quality control and testing of materials, components and systems. In essence, the builder attempts to construct a submersible following sound engineering principles and practices. As shown in this chapter, there is no legal requirement for the builder to adhere to any particular guideline, but if he wishes to lease to the U.S. Navy or other governmental agencies the vehicle must meet standards selected by these agencies. Prevention of material failures, then, falls under the topic of material certification and the various standards are presented later in this chapter.

The operator of a private submersible need only meet his employer's or his own training and competency standards. These also are dealt with later. It is sufficient to note that sound engineering procedures and well-qualified, knowledgeable operators are the main ingredients of a safe diving program.

A third category under prevention of emergencies is Operational Safety—the process of predetermining whether a proposed mission is safe to undertake in the first place. Determining the risk factor in a proposed mission involves weighing the vehicle's design and capabilities against the nature of the job and the conditions one can anticipate at the job site.

One approach to this determination can be to take those Natural and Man-Made Hazards listed above and consider the likelihood of their occurring or hindering the submersible's operation. Such an approach involves thorough research into the literature concerning the candidate dive site. Having determined what the environment holds in store, one may then evaluate whether or not the vehicle can safely contend with these conditions. Unfortunately, this procedure is not quite so simple, because, though a great deal is known of the world oceans, it soon reduces to generalities and a submersible does not dive generally, it dives specifically.

While many difficulties lay in the path of gathering operational safety information, the results, no matter how meager, do provide some indication of what may be expected and may identify areas of investiga-

tion which the mission planners did not consider.

The final judgement on what is or is not a safe operational practice can be debatable. Generally the operations officer and the operator have sufficient experience and seamanship ability to provide expert opinion which the user follows. On the other hand, there are no time-honored principles in submersible diving as there are with military submarines, although some military operating procedures can be applied. What might be considered a foolish procedure for one submersible, may be entirely safe for another. It is not difficult to foresee where the present work of inspecting of oil well heads, pipelines and associated equipment will lead submersibles into conditions as potentially hazardous as a scuttled ship. And, being quite practical, if that's where the money is the submersible owner faces two options: Do the job or go out of business. Hence, judging the safety or risk of a particular task is accompanied by economic considerations which may prompt the commercial user to attempt a maneuver the scientific user feels too risky.

## U.S. NAVY CERTIFICATION

The U.S. Navy defines a manned submersible as “. . . *any ship, vessel, capsule or craft capable of operating underwater with or without propulsion, on and under the surface of the water with the operator(s) and/or passengers embarked in a dry habitat and which by its design is incapable of defensive or offensive action in combat*” (Secretary of the Navy Instruction 9290.1A). This definition includes habitats such as **SEALAB**, rescue chambers of the McCann type and tethered and untethered manned submersibles, both military and non-military. Provisions of this instruction allow military or civilian naval personnel with proper authority to dive in a non-certified vehicle on an occasional or one-time basis for specified purposes of indoctrination, evaluation or research. A vehicle can remain uncertified and still operate under Navy contract as long as naval personnel (military or civilian) do not dive in it.

Navy certification is divided into three areas: a) Systems certification, b) operator(s) competency and c) operational safety. The Chief of Naval Operations (CNO) was assigned the responsibility of assuring safety in these areas and delegated systems certification to The Chief of Naval Material (CNM), who subsequently directed the Naval Ship Systems Command (NAVSHIPS) to promulgate the criteria by which submersibles can be evaluated for certification. Submarine Development Group 1 (SUBDEVGRU-1) was designated as the inspecting activity for operators' certification, and their requirements are outlined in Chief of Naval Operations Instruction (OPNAVINST 9290.3). Chief of Naval Operations (OP-23) is the recipient of information on operational safety aspects and pertinent environmental data.

### Systems Certification

Certification of a submersible for material and procedural adequacy must be obtained by the Naval user prior to signing a contract for lease or purchase. When a naval activity contracts for construction of a vehicle the certification requirements must be invoked. Those submersible systems which material and procedural adequacy treats fall under the Certification Scope and “. . . *includes the sea water pressure boundary, the materials, equipment, and operating procedures systems, needed to recover from a malfunction or accident and above all a system for sustaining life which will permit recovery of the operators, divers, or occupants of the Deep Submergence System without unduly impairing their health or well being.*” (8). Examples of such systems or equipment are:

- Pressure hull, hard structure and appurtenances
- Ballast systems
- Life support systems
- Jettisoning systems
- Non-pressure compensated equipments subject to implosion
- Release devices for external appendages
- Fire fighting devices or systems
- Intership/intraship communications systems
- Depth measurement devices
- Obstacle avoidance systems and electric propulsion motors as applicable

- Accessibility to vital equipment
- Submersible stability and buoyancy
- Buoyancy materials and/or devices
- Electrical power systems
- Operating procedures

A detailed and lucid explanation of the requirements for systems and procedural adequacy is presented in NAVMAT Publication P-9290 of July 1973 *System Certification Procedures and Criteria Manual for Deep Submergence Systems* which is available to the public through the Government Printing Office.

To obtain Navy certification a submersible must first be sponsored by a projected Naval user. Only the highlights of Navy material certification will be discussed, and information regarding this aspect of certification was obtained mainly from the above NAVMAT publication.

### Required Records

The scope of certification is not a pre-determined list of Naval demands but is a detailed list of those portions of the submersible which in the builder's judgement fall within the certification scope.

Additionally, the applicant is asked to provide the criteria and supporting justification for limiting the scope of certification. Generally, the following procedures are expected:

- the applicant must establish and identify the pertinent design parameters, *e.g.*, operating depth, safety factors, design life, etc., used in the design and needed to evaluate the safety of the submersible;
- a design review report should be submitted which minimally includes a summary description of the vehicle, design parameters, agreed-upon certification scope, system descriptions, operability and maintenance criteria and procedures and material justification;
- the design of each system, including the fluid, electrical, compressed air and gas systems, must be described by the applicant;
- design calculations which state all assumptions and rationales used in the analyses must be submitted to demonstrate the adequacy of design;
- test reports, used to justify design adequacy, must be self explanatory, conclu-

- sive, and must include a description of the test set-up, test conditions, instrumentation and accuracy of measurement;
- up-to-date copies of the manufacturing drawings of each component and system evaluated in the design analysis must be submitted;
  - it is desired, but not a stated requirement, that there also be submitted such analyses as an information flow diagram, an operational sequence diagram and a human engineering analysis of the instrumentation and control station layout;
  - all materials used within the certification scope in the design of the vehicle for expected service environments must be justified. This is to determine the possibility of galvanic corrosion on adjacent materials, and emission of noxious odors from points, insulation or other components within the vehicle which may give off such odors below 200°F. Flammable materials are also considered.

### Introduction of New Materials

To anticipate the introduction of new materials into a rapidly advancing technology, candidate materials and/or components are grouped into the following categories:

**Category 1:** Materials and/or components which have had a considerable amount of fabrication and operational experience in the intended environment and for the intended application. Examples are HY 80 and HY 100 plate (MIL-S-16216) for spherical or cylindrical pressure hulls 70/30 Cu-Ni (MIL-C-15726) valve bodies and lithium hydroxide (LiOH) for CO<sub>2</sub> removal at ambient pressure.

**Category 2:** Materials and/or components which have had a considerable amount of commercial operational use but lack an appreciable degree of experience in a marine environment or in the proposed application. Examples in this category are given as certain types of aluminum, tita-

nium and several high and low strength steels.

**Category 3:** Materials and components for which definitive information and experience are not yet available. Examples in this category are such pressure hull materials as ultra high strength steel, titanium, aluminum, ceramics, plastics or glass or combinations of these.

The burden of proof that the material or component is adequate and the justification of the acceptance criteria is upon the applicant who must present such to the reviewing board.

### Construction and Fabrication Processes

The applicant must also meet various requirements in regard to the construction and fabrication processes for systems within the certification scope. These processes include work procedures, heat treating instructions and welding and assembly procedures. In essence, the applicant should include all construction and fabrication procedures that affect the design performance of the system or component.

### Quality Assurance

The applicant must demonstrate that an effective quality control program has assured that all design requirements of the systems and components within the certification scope of the submersible are met in order to assure vehicle safety.

### Testing

Systems within the scope of certification must be tested to demonstrate their adequacy, *e.g.*, pressure hull strength, flotation and buoyancy systems, emergency deballasting and jettisoning systems, electrical insulation integrity and safety features. Three general testing categories are required:

**development tests:** To verify the performance of materials, mechanical designs and systems which are unique to the marine environment;

**quality assurance tests:** To demonstrate that the components, materials and fabrication of the vehicle meet the requirements of design;

**operational and proof tests:** To confirm the designs and operational characteristics of the submersible.

These are further divided into Pre-Sea Trial Tests and Sea Trial Tests. In the latter, tests within a single dive or a series of dives are made to the vehicle's maximum operating depth with members of the certifying team on board.

### **Operability and Maintenance**

Written procedures are required for both the normal and emergency submersible operations, as well as a checklist of major evolutions such as repair, maintenance and inspections. Appendix III presents daily maintenance routine and checklist as an example of such procedures.

### **Survey of the Submersible**

Subsequent to all dockside testing, a survey of the vehicle will be made to determine that it was actually built and will perform as designed. The survey team is composed of naval and applicant representatives.

### **Tenure of Certification**

Once having obtained Navy certification the sponsor user or operator must maintain review records and procedures in order that the vehicle remains certified. Certification is not granted for the design life of the vehicle, but is generally based on its intended mission profile and operating and test history. Major overhauls, expiration of a lease or breaching the scope of certification automatically terminates material certification. The tenure of certification is categorized into three areas: 1) Sustaining certification, 2) Continuance of certification and 3) Recertification.

1) **Sustaining Certification** —This is action to assure that the submersible remains in the "as certified" condition for the period of certification. Sustaining certification is generally the responsibility of the Naval user and the civilian operator. In order to sustain certification the responsible party must apprise NAVSHIPS of the following: All design changes within the certification scope or those which could change the certification scope; that repairs and maintenance have been conducted so that all systems and components within the scope of certification op-

erate normally before each dive; that required periodic inspections of certification scope systems and components have been performed and the results forwarded; and that the vehicle has and will operate within its certified operational limits. Finally NAVSHIPS must be advised of all abnormal situations such as excursions below certified depth, collisions, grounding, entanglements, fires and emergency ascents.

2) **Continuance of Certification** —This category applies to the extension of certification beyond the initial period granted, and it normally accommodates continued use of a vehicle which has undergone no changes to the basic design, the scope of certification or general operating characteristics. To maintain this condition all the requirements and procedures of "Sustaining Certification" must be observed.

3) **Recertification** —Breaching the scope of certification, major overhauling or termination of a lease shall cause the initial certification to expire, and the applicant must reestablish a scope of certification and fulfill all the requirements that were necessary for initial certification.

### **External Instrumentation**

Instrumentation or devices external to the submersible also fall within the scope of certification, although they may have nothing to do directly with the operation of the vehicle. The potential hazard of such instrumentation—*e.g.*, manipulators, transducers, oceanographic sensors, cameras, etc.—may rest either in their imploding, if not pressure-compensated, or in their becoming entangled and immobilizing the vehicle if the instrument is not jettisonable.

In the case of the pressure-resistant (vs. pressure-compensated) component or system implodable volume and standoff distance are the critical factors. If the volume of the instrument is such that by imploding it could cause a casualty to any component within the certification scope it must be mounted a minimum "standoff" distance from such critical components so that if an implosion occurred the component would not be affected. The guidelines for determining the criticality of systems and/or components which may implode and cause material damage are pre-

sented in reference (8), and a sample calculation is presented in Figures 13.8 and 13.9. It is noted that this sample calculation applies only to spherical pressure hulls of design crush depth 1.5 times or greater than the design depth and not fabricated from a brittle material such as glass or ceramics.

When a non-pressure compensated item has a critical implodable volume and cannot

be waived from a NAVSHIP's point of view, then the component must be cycled nine times to 1.5 times its operating depth and held at that depth for 10 minutes on each cycle; on the tenth cycle it must be held at greatest pressure for 1 hour (35°F in seawater is recommended). Any leakage or visible indications of change result in test failure.

Where instruments extend beyond the ve-

#### MINIMUM STANDOFF DISTANCE FROM A SPHERICAL DSS FOR AN IMPLODABLE CAMERA CASE

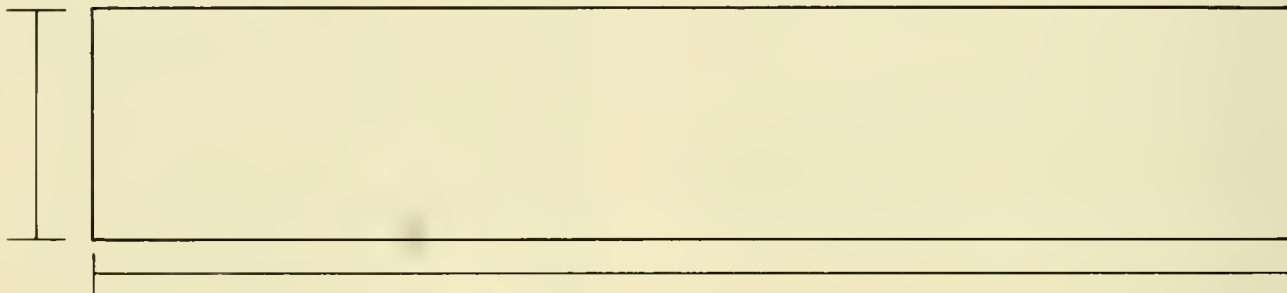

1. CALCULATE INSIDE VOLUME

$$V = \pi (3/2)^2 \times 16$$

$$V = \pi (9/4) \times 16 = 36 \pi = 113 \text{ CUBIC INCHES}$$

2. ENTER GRAPH UNDER MAXIMUM DESIGNED DEPTH OF 6000' AND VOLUME OF 113 CUBIC INCHES TO GET K-FACTOR.

$$K \sim .85$$

3. MULTIPLY K-FACTOR BY  $\frac{1}{\sqrt{R}}$  WHERE R IS THE PRESSURE HULL RADIUS IN FEET.

$$R = 3.5' \rightarrow (3.5)^{1/2} = 1.87$$

$$\text{MINIMUM STANDOFF DISTANCE} = \frac{.85}{1.87} = .455$$

$$\text{MINIMUM STANDOFF DISTANCE} \cong 5\text{-}1/2''$$

THIS IS THE MINIMUM STANDOFF FOR CONSIDERING AN ITEM OF "NON-CRITICAL VOLUME." TESTING PER PARAGRAPH C.3 OF REF. (8) WOULD NOT BE REQUIRED AS LONG AS THE HULL STANDOFF IS GREATER THAN 5-1/2" AND THE ITEM IS NOT LOCATED WITHIN 5-1/2" FROM ANY CERTIFICATION SCOPE ITEM.

Fig. 13.8 Sample calculation (assume spherical DSS has 6,000-ft maximum design depth).



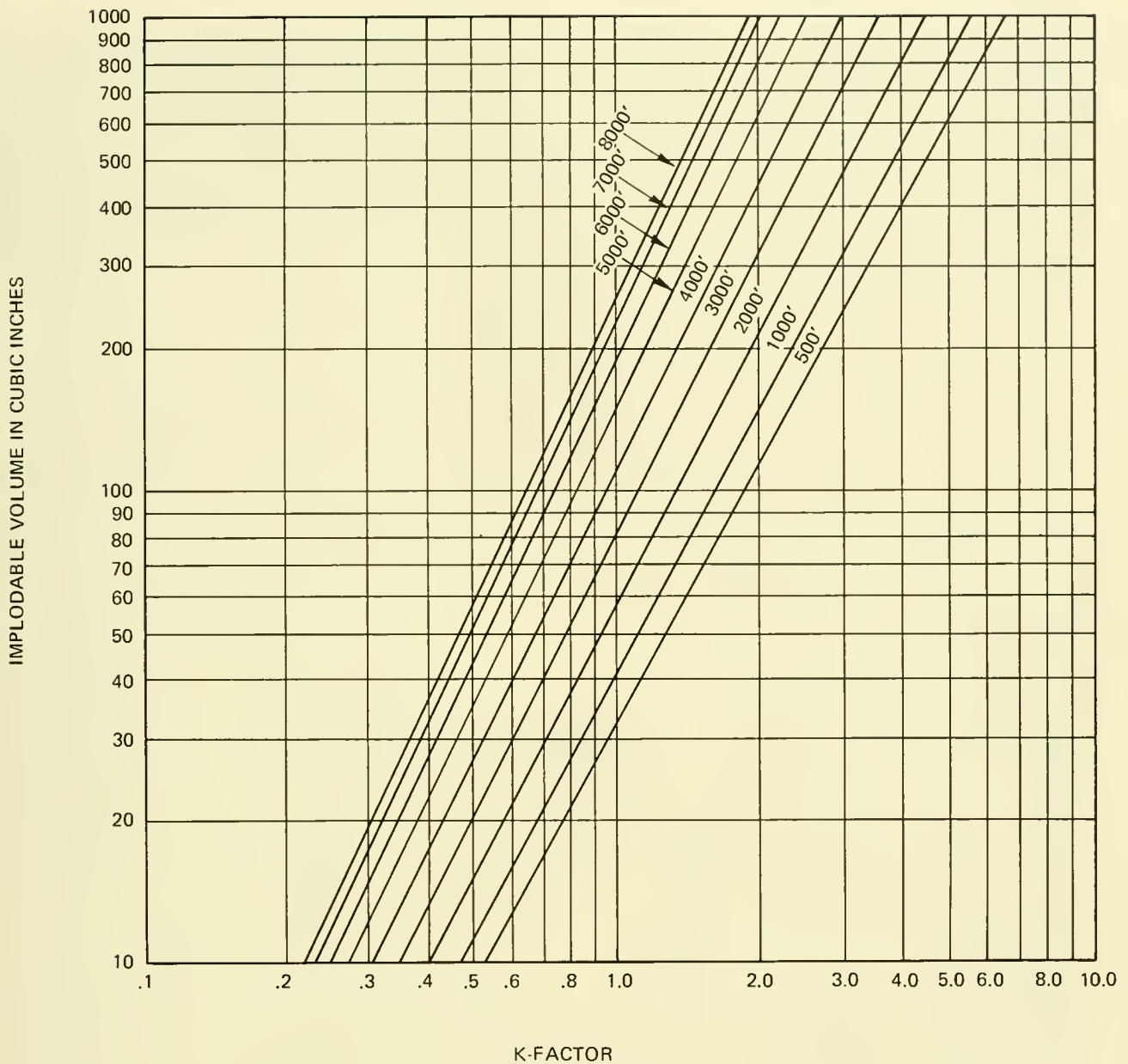

Fig. 13.9 Minimum standoff distance for implodable items (spherical pressure hull).

hicle's greatest diameter and fouling on a wire or line is a distinct possibility, the rules are flexible. There is no limit to the size of an object which can be attached externally to the vehicle, but if it apparently protrudes to the point where fouling is possible it must be jettisonable. Again, there is no required method of jettisoning, but pyrotechnic release devices, *e.g.*, explosive bolts (Fig.

13.10), are preferred over weak-link devices. One type of component which can cause problems in this area is the manipulators or mechanical arms. If in the process of repairing or moving a heavy cable or piece of hardware, the manipulator fails and its grip cannot be released or if it becomes fouled in an appendage, it must be possible to jettison the arm(s). In general, the more streamlined

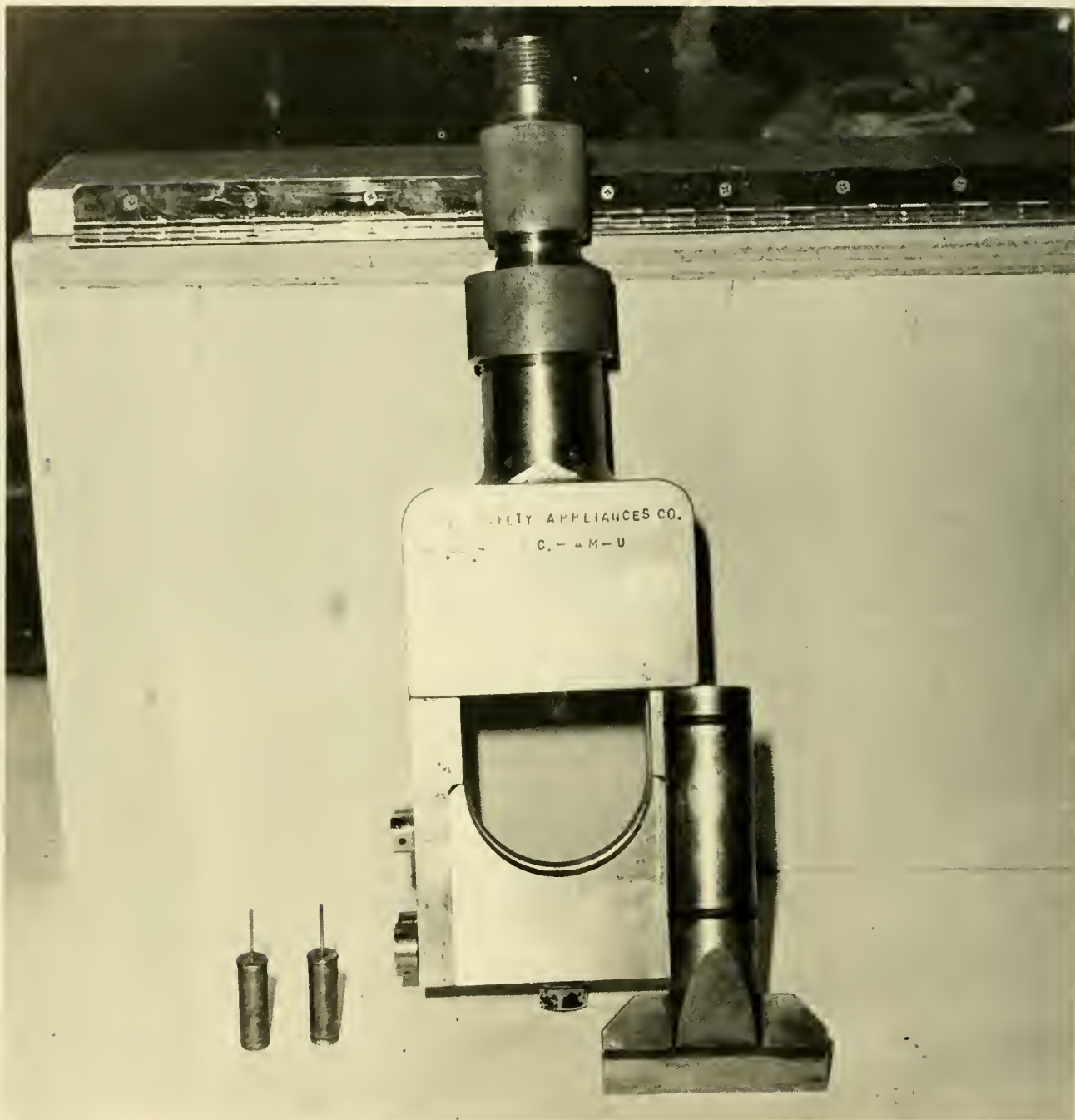

Fig 13 10 All power cables and support cables leading from the brow on *DEEPSTAR 2000* can be severed by the guillotine cutter on the right by electronically actuating an explosive squib (left) from within the pressure hull.

the submersible the easier it is to certify in terms of snagging or fouling potential.

A flow diagram showing the milestone events of material certification is presented in Figure 13.11.

### **Operator Competency**

According to OPNAVINST 9290.3, operators of a submersible include “. . . *those personnel who physically control the operating parameters of the submersible such as*

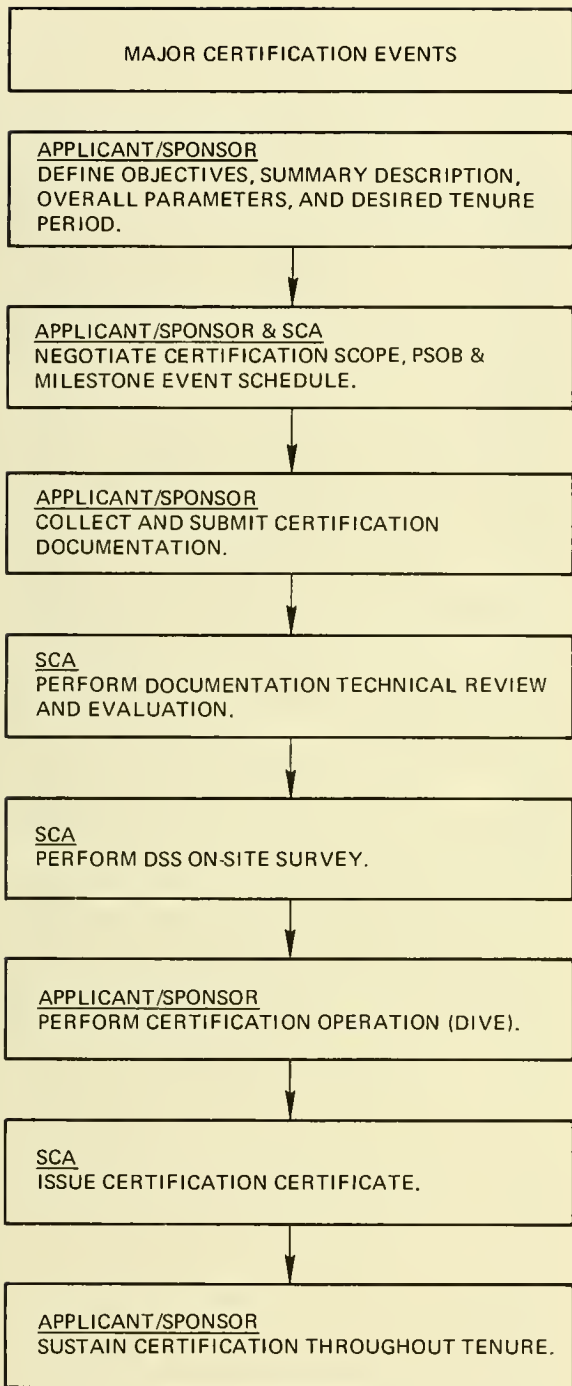

Fig. 13.11 Flow chart, system certification milestone events.

*depth, course, speed, pitch, roll, etc. Operators include those crew members whose control functions are essential to the safe operation of the submersible."*

Except in special cases, all Navy-owned submersibles require operators who are military personnel and "Qualified in Submarines." In the case of privately-owned submersibles leased by the Navy and Navy submersibles operated (piloted) by civilians the following documents are required which the sponsor or prospective user must assure are forwarded:

- 1) A written statement of physical examinations and certification of the operator's fitness by a medical doctor;
- 2) A copy of the physical requirements set forth by the operator's employer;
- 3) A résumé of the operator's background and level of competence;
- 4) Scuba qualifications (for lock-in/lock-out submersibles);
- 5) Operator's qualification notebooks if required by the operator's company;
- 6) Dive Logs if maintained by pilot.

This information is reviewed by Submarine Development Group One which also conducts an in-depth interview of each pilot expected to operate the submersible during the lease period. This interview is to determine the operator's knowledge of the submersible design, construction, operation and handling characteristics. After determining that the foregoing is satisfactory a qualified officer is designated to dive in the vehicle and observe the operator(s) during a demonstration dive which requires operations similar to those anticipated during the lease period. Qualification as a pilot in one submersible is not transferable to a different submersible.

Operator recertification is required when the operator has not piloted the vehicle for 6 months or after a major equipment change or major alteration (as determined by CNM).

The naval passengers themselves are also required to undergo submarine physical and psychiatric examinations before they can dive and must repeat these examinations at periodic intervals (every 3 years for the mental examination and annually for the physical).

#### **The Deep Submersibles Pilots Association**

Qualification requirements of operators or pilots as recommended by the Deep Submersibles Pilots Association are in general agreement with Naval standards. Membership in

the Pilots Association, a voluntary organization begun in 1967, requires a person to have been the pilot in command of a submersible on at least five dives with one to the minimum depth of 200 meters. The association considers the following as constituting pilot requirements and training:

**Experience** —A solid background of sea-going experience is primary, and scuba diving, aircraft flying, power boat maneuvering and submarine experience are desirable, but not necessary. Motivation and demonstrated work competence are the selecting criteria.

**Physical Requirements** —Navy physical requirements for submarines are considered too stringent, but may serve as a guideline for ascertaining the required good general health.

**Psychological Requirements** —Stability, maturity and general reliability and competence should be demonstrated, if possible, under actual diving operations.

**Training and Familiarization** —The candidate should display a working knowledge of: Diving principles, submersible construction, operational performance and emergency procedures; environmental limits (physiological) of living in a closed environment; test, maintenance and overhaul procedures and surface support requirements and procedures; small boat piloting; the ocean environment; and some first aid.

**Operational Training** —The candidate must successfully demonstrate his ability to: Maneuver and launch/retrieve the submersible under both normal and emergency conditions; operate all normal and mission oriented equipment; perform support functions and maintenance; and successfully deal with such environmental systems emergencies as might occur in the cabin (pressure capsule) when submerged.

The Association considers a pilot's qualifications to be current if he is continuously and actively involved in the submersible's operation. If he is not actively involved for a period greater than 6 months or if a major equipment change has occurred with which he is not familiar he should requalify. Qualifications from one submersible design to another are not transferable. Annual physical

examinations are required and age, by itself, is not a disqualifying factor.

### **Operational Safety**

Owing to the controls which can be and generally are applied, the prospects of a submersible getting into trouble due to material failure and operator incompetence are unlikely. On the other hand, the lack of operational experience and the gross nature of our basic oceanographic knowledge provide ample opportunity for at-sea mishaps. (See Chapter 14.)

By direction of OPNAVINST 9290.2 series the naval users of submersibles are held responsible for assuring non-interference with surfaced or submerged shipping in the projected operations area. They must evaluate environmental conditions which may affect communications and the operation and must insure that dates, times, locations, description of the submersible and support ship and the nature of the operation are published in the appropriate *Notice to Mariners*. Additionally they must, through the Commander Submarine Force, U.S. Atlantic Fleet, reserve an area of operations that precludes interference with Naval operations. Along with the above information they must also submit to the Chief of Naval Operations (OP-23) the mission objectives, detailed plan of activities, rescue and salvage plans, area assignments and communication plans. The operational safety aspects of submersible certification are a consideration almost equally as detailed and demanding as material certification to the naval user. Indeed, as more submersibles are used and as more attention is focused on this area, certification of operational safety shows every indication of assuming equal importance.

Full Naval Certification is not only costly but time-consuming. It can take from several months to several years, and the prospective user must be prepared well in advance for problems of variety and complexity, both with hardware and personalities.

## **AMERICAN BUREAU OF SHIPPING CLASSIFICATION**

Classification by the American Bureau of Shipping (ABS) is voluntary and represents

the only detailed civilian guides for submersible construction. Classification by the Bureau is instigated by the submersible owner at his request, and all expenses incurred in the process are borne by him. These expenses may range from \$2,500 for a **NEKTON**-type vehicle to over \$25,000 for a **BEN FRANKLIN**-type vehicle (M. Letich, ABS, personal communication).

The American Bureau of Shipping defines a submersible as “. . . *any vessel or craft capable of operating under water, submerging, surfacing and remaining afloat under weather conditions not less severe than Sea State 3, without endangering the life and safety of crew and passengers.*” In their *Guide for the Classification of Manned Submersibles* (9) they present the requirements and procedures which must be considered in the certification of a submersible by ABS.

ABS states in the foreword to their guide that their limited commercial experience in submersible operations requires that the guide be considered as an attempt to make various procedures and techniques available to designers until sufficient operating experience is available from which more definitive requirements can be formulated. In essence, the guide presents the minimum required information for drawings and calculations which must be submitted for classification. Additionally, a portion of the guide deals with surveys required during and after construction by ABS surveyors.

### Required Drawings

- Pressure hull and appurtenances
- Non-pressure hull (superstructure, fairwater, etc.)
- Tanks not subject to submergence pressure
- Foundations to equipment
- Ballast and blow systems
- Deballasting/jettisoning systems
- Release devices for external appendages
- Anchor, lifting and handling systems
- Propeller
- Propulsion machinery with shafting, bearings and seals
- Control surfaces
- Electric wiring and equipment
- Life support systems

- Fire fighting systems
- Intership communication systems
- Ship-to-shore communications

### Required Calculations

- Stability (normal and emergency)
- Buoyancy
- Equilibrium polygon
- Minimum freeboard
- Foundations to vital equipment
- Tanks subject to submergence pressure
- Pressure hull
- Life support
- Lifting and handling attachments
- Electric load analysis
- Piping systems vital to crew safety and vehicle survival

### Buoyancy Characteristics

1) **Surface Buoyancy**—Through calculations and/or tests demonstrate that the vehicle can surface and remain so without jeopardizing vehicle safety in normal sea conditions (Sea State 3) and with adequate freeboard.

2) **Neutral Submerged Buoyancy**—Through calculations and/or tests demonstrate the vehicle's ability to hover at a fixed depth at even keel at zero speed while submerged and under all loading conditions unless acted upon by an outside force.

### Stability and Trim Characteristics

The designer must demonstrate through calculations and/or tests that the stability and trim characteristics of the vehicle are adequate for the following **Normal** conditions:

- 1) Operating on the surface
- 2) Transient
- 3) Underwater operation

The designs must also show by calculation and/or tests that under any possible combination of dropped jettisonable weights the submersible would retain adequate stability; this is referred to as **Emergency or Damage Condition**. Additionally, the vehicle's ability to survive within certain identified damaged conditions should be verified by calculation and/or testing.

### Ballast System Requirements

Owing to its extreme importance to safe

operations, complete details of ballast system materials and design are to be submitted with special attention given to methods of attachment to hull and protection against external damage. Tanks and piping materials must be tested and inspected in accordance with ABS rules where applicable. Fabrication, installation and testing of the ballast system should be carried out in the presence of ABS surveyors.

### **Maneuverability and Controls**

If rudders and/or diving planes are used for maneuvering, detailed drawings of them must be submitted which include steering mechanisms and necessary controls. All submersibles are required to have some means of determining their location and avoiding obstacles when submerged.

In addition to the general guidelines presented above, the ABS manual provides excellent guidance of a more specific nature on the design, construction, and testing of the pressure hull, "exostructure," environmental control, mechanical equipment, electrical equipment, emergency equipment, procedures followed during surveys and lock-in/lock-out contrivances. The ABS also requires submission of a spare parts list, and the appendices to the manual deal with supporting data for Class II materials and sustaining data for Class III materials (similar to Naval classification of materials I, II, III). Requirements for toughness testing, X-ray acceptability standards and environmental control parameters are also to be included.

Adherence to the ABS guidelines during submersible construction does not imply that certification by the Navy is a rubber-stamping effort, since several areas of the vehicle's construction and operation are dealt with in different fashion by both. However, the ABS guidelines have drawn heavily on naval submarine experience. Indeed, several members of the committee who contributed to this manual are directly or indirectly involved with Naval certification.

The original 1968 ABS Guide is being expanded and revised, and will be published as the "*Guide for the Classification of Underwater Vessels and Related Systems.*" The new guide, according to Letich (11), will include:

- 1) Lock-out submersibles
- 2) Tethered submersibles
- 3) Submersible vehicles
- 4) Small submersibles
- 5) Stationary underwater vessels
- 6) Support ships
- 7) Diving systems
- 8) Launch and recovery gear
- 9) Equipment including requirements on anchors and chains, lines and umbilical cords.

The submersible builder of today is in a far better position to build a safe, certifiable vehicle than his predecessor, for the combination of the NAVMAT criteria, the ABS guidelines and the guidelines presented in Marine Technology Society's *Safety and Operational Guidelines for Undersea Vehicles* provides a wealth of knowledge heretofore unavailable to early submersible builders.

## **U.S. COAST GUARD REQUIREMENTS**

Present U.S. Coast Guard submersible regulations are essentially non-existent owing to lack of legal authority pertaining to the small submersibles now operating. All submersibles presently operating under a U.S. flag and which carry no more than six passengers fall under the Motor Boat Act of 1971 and must comply with "*Rules and Regulations for Uninspected Vessels,*" subchapter 6, CG-258. This act requires that the submersible have running lights, a fire extinguisher and life preservers for each person aboard, and that it display its state registration number (personal communication, CDR Charles B. Glass, USCG).

In the case of the following submersibles the regulations governing surface ships again apply, but are more stringent and complex by requiring that the submersible owner show the vehicle to have been built following good engineering practices:

- a. Submersibles not more than 65 feet in length and under 100 gross tons carrying more than six passengers;
- b. Submersibles more than 65 feet in length and over 15 gross tons carrying passengers for hire;
- c. Submersibles more than 15 gross tons carrying freight for hire;

- d. Submersibles 100 gross tons or more carrying passengers;
- e. Submersibles 300 gross tons or more;
- f. Any submersible carrying combustible or flammable liquid in bulk;
- g. Any submersible carrying dangerous cargo.

The standards to be met are based upon the Coast Guard's background of engineering talent, which additionally draws from U.S. Navy and American Bureau of Shipping certification requirements and the procedures outlined in the Marine Technology Society's guidelines for undersea vehicles. The proposed civilian use of ex-military submarines for under-ice surveys in the Arctic would fall under this category.

## SEARCH AND RESCUE RESPONSIBILITIES

Contrary to its present limited role in submersible certification, the Coast Guard has the sole responsibility for search and rescue of civilian submersibles. Though presently limited in its own undersea rescue capability, the Coast Guard may request assistance from the U.S. Armed Forces under the general concepts of a National Search and Rescue Plan referred to as SAR. This plan is a federal inter-agency agreement established to assure coordinated response among federal agencies in the event of a search and rescue emergency. Briefly, it works as described below.

There is a Coast Guard Rescue Control Center (RCC) in each of its 12 districts, and within each district are several SAR stations. The operators of a submersible in distress contact the nearest SAR station on 2182 kHz or 156.8 MHz and informs it of the nature, location, etc., of the emergency. The SAR station begins taking immediate action with whatever assets it has on hand, and concurrently informs the RCC within its district. In the event that the need arises for underwater rescue calling for assets beyond those of the Coast Guard, the RCC requests assistance from Chief of Naval Operations (CNO) who provides such through the Navy's Supervisor of Salvage (SUPSAL). An on-scene commander (OSC) is designated by CNO to carry out rescue procedures as he sees fit.

As one step in expediting safe civilian submersible operations, the Coast Guard established a voluntary reporting system to: 1) Provide immediate information to their Rescue Coordination Centers in the event of an emergency; 2) lessen the possibility of incorrectly identifying the submersible as a foreign naval submarine; 3) prevent undersea conflicts with other surface or subsurface vessels in the area of operation; and 4) provide the general maritime community with notice that such operations are being conducted.

In a notice to all owners, manufacturers and operators of civilian submersibles, dated 11 August 1967, the Coast Guard Commandant asked for cooperation in providing to the nearest Coast Guard District Commander the following information prior to commencement of each operation:

- a. General submersible description;
- b. Operations area, surface and submerged;
- c. Dates and times of start and termination of operation;
- d. Any special methods of warning surface ships of surfacing intentions;
- e. If surface craft accompanying, give general description of such;
- f. Emergency communications capability of support ship and submersible;
- g. Information helpful in event of distress, *e.g.*, escape capability, life support duration, flotation gear and location aids aboard submersible.

According to Lieutenant R. Pyzer, USCG (personal communication), response to this request was excellent initially, but has gradually become a "sometime thing" in all but military-owned and federally-leased vehicles. With the recent **JOHNSON SEA LINK** and **PISCES III** incidents (see Chapter 14), however, compliance with this request has increased in the private sector.

## MARSAP

An acronym for Mutual Assistance Rescue and Salvage Plan, MARSAP is an attempt by industry's owners of submersibles to be able to render assistance to a distressed submersible. The MARSAP report and recommenda-

tions (never formally published) cover various standard equipment a member-submersible should carry and techniques employed in a rescue situation. The plan, however, ran into some difficulty regarding indemnification and liability of the rescuer, and has languished since its inception in 1967.

## INSURANCE

According to the Marine Technology Society's Guidelines (10), the owner or operator of a submersible is required by law to carry insurance covering employees engaged in the operation of a submersible and the support ship. This coverage is required for any employee subject to:

1. U.S. Longshoreman's and Harbor Worker's Compensation Act, U.S. Code (1946) Title 33, Section 901-49 or,

2. U.S. Longshoreman's and Harbor Worker's Compensation Act as extended by act of August 7, 1953 (Public Law 212, 83rd Congress, the Outer Continental Shelf) or,

3. The Defense Bases Act, U.S. Code (1946) Title 42, Section 1614-54 (Public Law 208, 77th Congress as amended) and the provisions applicable thereto under the Longshoreman's and Harbor Worker's Compensation Act, U.S. Code (1946) Title 33, Section 901-49.

The owner/operator should carry Bodily Injury Liability and Property Damage Liability in sufficient amount to provide the necessary protection in the event of an accident.

Additionally, the owner/operator should carry all Risk Marine Insurance to cover accidental damage and/or loss to the submersible.

Insurance coverage for total loss of the vehicle, though desirable, is not always obtained. Companies such as Perry Submarine Builders are self-assuring because the cost of total (hull) coverage would put them out of the competitive market.

Legal requirements for submersibles of other nations appear to be essentially the same as in the U.S.; requirements are up to the user. Canadian private submersibles generally seek to attain ABS certification. The Canadian Armed Forces vehicle (*SDL-1*) has received such and operates under its

own set of requirements similar to its U.S. Naval counterparts.

According to Dr. Tadayoshi Sasaki (12), when design work began on *YOMIURI* concern was expressed to the Japanese Ministry of Transportation regarding the lack of rules and regulations ensuring safety of civilian submersibles. As a result, in September 1963, the *Inspection and Technical Standards for Submarine Boats* were established as a part of the Safety Law for Ships (*Senpako Anzen Ho*) and *YOMIURI* was designed and constructed in accordance with this law. Sasaki further stated that this law was partly amended in September 1966 and is in force today (1970).

On the other hand, Dr. Tamio Ashino (13), of Japan Ship's Machinery Development Association, defines these regulations as provisional and only deal with the structures, facilities, and methods for inspection of submersibles. There are no operator's qualifications, but it is necessary to get the approval of the Ministry of Transportation's Seamen Bureau based upon their Section 20, *The Regulation for Crews of Ships*. Dr. Ashino further relates that there is no present procedure for reporting submersible operations, but one will be established when the Japanese Maritime Agency attains a rescue capability.

In the United Kingdom, Lloyds Register of Shipping has drawn up a set of rules and regulations for the construction and operation of submersibles. These regulations are for insurance purposes (K. R. Haigh, Admiralty Experimental Diving Unit, personal communication) and serve the same purpose as ABS classification.

Similar insurance inspection guidelines were written by Germanischer Lloyd, Hamburg, in 1971 and are entitled *Regulations for the Classification and Construction of Submersibles*.

Mr. James Dawson (14) presents an excellent, if not the only, account of submersible insurance from an underwriter's viewpoint. Dawson states, "*It is virtually a prerequisite to buying insurance to have certification from a classification society already approved by the underwriters . . . then in all probability (the underwriter will) require an expert consultant's report and*



*recommendations before they will actually quote terms and rates.*" Classification by ABS, Lloyd's Register of Shipping and Germanischer Lloyd is acceptable. Interestingly, Dawson (a member of Lloyd's of London) strongly opposes legislation which would 'police' the submersible industry because: 1) the extraordinary record of safety in the industry is proof of its safety consciousness, and 2) the concept opens the prospect of certification withdrawal for political reasons in order to protect domestic operations from thrusting exporters.

Information regarding regulations on, French, Italian or Russian vehicles is not available.

## REFERENCES

1. Glass, C. B. 1969 *A Coast Guard role in civil submersible safety*. Soc. Automotive Engineers, Pub. 690027, presented at the International Automotive Engineering Congress, Detroit, Mich., 13-17 Jan. 1969.
2. Shumaker, L. A. 1967 *Safety Standards for Deep Submersible Vehicles*. Paper 67-819 presented at AIAA 4th Annual Meeting and Technical Display, Anaheim, Calif., Oct. 1967.
3. Pritzlaff, J. A. 1967 *Submersible Safety, Classification Certification and the Law*. Paper 67-WA/UNT-5 presented at ASME Winter Annual Meeting and Energy System Exposition, Pittsburgh, Pa., Nov. 1967.
4. Busby, R. F., Hunt, L. M. and Rainnie, W.O. 1968 *Hazards of the Deep*. Ocn. Ind., v. 3, Nos. 7, 8, & 9, p. 72-77, 32-39, 53-58, respectively.
5. Pollio, J. 1968 *Undersea Studies With The Deep Research Vehicle STAR III*. U.S. Naval Oceanographic Office, I.R. No. 68-103, 71pp.
6. Cousteau, J.Y. 1955 *Diving through an undersea avalanche*. National Geographic, p. 538-542.
7. Melson, L. B., *Contact 261*. U.S. Naval Inst. Proc., No. 6, v. 93, 1967, p. 26-39.
8. Naval Material Command Publication P-9290 1973 *System Certification Procedures and Criteria Manual for Deep Submergence Systems*. U.S. Gov. Printing Office, Wash., D.C. 20402.
9. American Bureau of Shipping 1968 *Guide for the Classification of Manned Submersibles*. New York American Bureau of Shipping.
10. Marine Technology Society 1968 *Safety and Operational Guidelines for Undersea Vehicles*. Wash., D.C., Marine Technology Society.
11. Letich, M. J. 1973 *New priorities in ocean engineering*. Proc. Mar. Tech. Soc. 9th Ann. Conf., Sept. 10-12, Wash., D.C., p. 401-407.
12. Sasaki, T. 1970 *On underwater observation vessels in Japan*. Trans. 6th Ann. Conf. & Exhibition, 29 June-1 July 1970, Mar. Tech. Soc., Wash., D.C., v. 1, p. 227-251.
13. Ashino, T. Manager Promotive Headquarters of Oceanic Machinery Dev., Japan Ship's Machinery Dev. Assoc., Tokyo, Personal communication of 25 Dec. 1973.
14. Dawson, J. W. 1970 *Vehicle development and operations—Europe*. Preprints 6th Ann. Conf. and Exposition, June 29-July 1, Marine Tech. Soc., Wash., D.C., v. 1, p. 263-267.





# 14

## EMERGENCY DEVICES AND PROCEDURES

There are three basic categories of emergency-related devices and procedures: 1) Those designed to avoid emergency situations; 2) those designed to extricate the vehicle from a submerged emergency and to assist in resolving a surfaced emergency; and 3) those designed to assist rescue operations when the vehicle's own emergency alternatives fail.

Table 14.1 presents the variety of responses each vehicle has at its disposal, and it is accurate insofar as built-in systems (weight-drops, ballast blow, hull release, emergency breathing, etc.) are concerned. It seems reasonable to assume that flashlights and fire extinguishers are carried by all; the same assumption may be incorrect where

anchors and flares are concerned. The U.S. Coast Guard requires that life preservers, running lights, an anchor light and fire extinguisher be carried; this may be considered as the minimal safety/emergency equipment on all U.S. submersibles.

### EMERGENCY AVOIDANCE SYSTEMS

Devices and instruments carried on submersibles to avoid and warn of potential emergency situations are presented in Table 14.2. Two factors critical to avoiding emergencies are not included: a pre-dive checkoff list and sound judgement. The former, if thorough and followed, can prevent a great

TABLE 14.1 SUBMERSIBLE EMERGENCY SYSTEMS AND DEVICES

	Auto matic De- ballast	Echo Sound- er	Obsta- cle Avoid- er	Atmos- phere Moni- tor	Man- ual Weight Drop	Man- ual Ballast Drop	Trim Fluid Drop	Equip- ment Jet- son	Pres- sure Blow	Pres- sure Release	Person- nel Egress	Releas- able Cap- sule	Closed Submgd Inflata- ble Breath- ers	Scuba Port Fixed	Emerg Ra- dio	Bot- tom Mount- ing Light	Ra- Rock dio Sig- nal Flares	Match Sail	Sur- face Inflat- ion Trunk Bags	Sur- face Mark- ing Buoy	Under- water Lanterns	Trans- ponder	Ping	External Connections Gas Air Elec	Life Rafts		
ALL OCEAN INDUSTRIES																											
ALUMINAUT	.	.	.	.	.	.	.	.	.	.	.	.	.	.	.	.	.	.	.	.	.	.	.	.	.	.	.
ALVIN	.	.	.	.	.	.	.	.	.	.	.	.	.	.	.	.	.	.	.	.	.	.	.	.	.	.	.
AQUARIUS	.	.	.	.	.	.	.	.	.	.	.	.	.	.	.	.	.	.	.	.	.	.	.	.	.	.	.
ARCHIMEDE	.	.	.	.	.	.	.	.	.	.	.	.	.	.	.	.	.	.	.	.	.	.	.	.	.	.	.
ARGYRONETE	.	.	.	.	.	.	.	.	.	.	.	.	.	.	.	.	.	.	.	.	.	.	.	.	.	.	.
ASHERAH	.	.	.	.	.	.	.	.	.	.	.	.	.	.	.	.	.	.	.	.	.	.	.	.	.	.	.
AUGUSTE PICCARO	.	.	.	.	.	.	.	.	.	.	.	.	.	.	.	.	.	.	.	.	.	.	.	.	.	.	.
BEAVER	.	.	.	.	.	.	.	.	.	.	.	.	.	.	.	.	.	.	.	.	.	.	.	.	.	.	.
BEN FRANKLIN	.	.	.	.	.	.	.	.	.	.	.	.	.	.	.	.	.	.	.	.	.	.	.	.	.	.	.
BENTHOS V	.	.	.	.	.	.	.	.	.	.	.	.	.	.	.	.	.	.	.	.	.	.	.	.	.	.	.
DEEP DIVER	.	.	.	.	.	.	.	.	.	.	.	.	.	.	.	.	.	.	.	.	.	.	.	.	.	.	.
DEEP JEEP	.	.	.	.	.	.	.	.	.	.	.	.	.	.	.	.	.	.	.	.	.	.	.	.	.	.	.
DEEP QUEST	.	.	.	.	.	.	.	.	.	.	.	.	.	.	.	.	.	.	.	.	.	.	.	.	.	.	.
DEEPSTAR 2000	.	.	.	.	.	.	.	.	.	.	.	.	.	.	.	.	.	.	.	.	.	.	.	.	.	.	.
DEEPSTAR 4000	.	.	.	.	.	.	.	.	.	.	.	.	.	.	.	.	.	.	.	.	.	.	.	.	.	.	.
DEEPSTAR 20000	.	.	.	.	.	.	.	.	.	.	.	.	.	.	.	.	.	.	.	.	.	.	.	.	.	.	.
DEEP VIEW	.	.	.	.	.	.	.	.	.	.	.	.	.	.	.	.	.	.	.	.	.	.	.	.	.	.	.
DGW8	.	.	.	.	.	.	.	.	.	.	.	.	.	.	.	.	.	.	.	.	.	.	.	.	.	.	.
DSRV 1	.	.	.	.	.	.	.	.	.	.	.	.	.	.	.	.	.	.	.	.	.	.	.	.	.	.	.
OSRV 2	.	.	.	.	.	.	.	.	.	.	.	.	.	.	.	.	.	.	.	.	.	.	.	.	.	.	.
FNRS 2	.	.	.	.	.	.	.	.	.	.	.	.	.	.	.	.	.	.	.	.	.	.	.	.	.	.	.
FNRS 3	.	.	.	.	.	.	.	.	.	.	.	.	.	.	.	.	.	.	.	.	.	.	.	.	.	.	.
GOLDFISH	.	.	.	.	.	.	.	.	.	.	.	.	.	.	.	.	.	.	.	.	.	.	.	.	.	.	.
GRIFFON	.	.	.	.	.	.	.	.	.	.	.	.	.	.	.	.	.	.	.	.	.	.	.	.	.	.	.
GUPPY	.	.	.	.	.	.	.	.	.	.	.	.	.	.	.	.	.	.	.	.	.	.	.	.	.	.	.
HAKUYO	.	.	.	.	.	.	.	.	.	.	.	.	.	.	.	.	.	.	.	.	.	.	.	.	.	.	.
HIKINO	.	.	.	.	.	.	.	.	.	.	.	.	.	.	.	.	.	.	.	.	.	.	.	.	.	.	.
JOHNSON SEA LINK	.	.	.	.	.	.	.	.	.	.	.	.	.	.	.	.	.	.	.	.	.	.	.	.	.	.	.
KUMUKAHI	.	.	.	.	.	.	.	.	.	.	.	.	.	.	.	.	.	.	.	.	.	.	.	.	.	.	.
KUROSHIO II	.	.	.	.	.	.	.	.	.	.	.	.	.	.	.	.	.	.	.	.	.	.	.	.	.	.	.
MAKAKAI	.	.	.	.	.	.	.	.	.	.	.	.	.	.	.	.	.	.	.	.	.	.	.	.	.	.	.
MERMAID I/II	.	.	.	.	.	.	.	.	.	.	.	.	.	.	.	.	.	.	.	.	.	.	.	.	.	.	.
MERMAID III/IV	.	.	.	.	.	.	.	.	.	.	.	.	.	.	.	.	.	.	.	.	.	.	.	.	.	.	.
MINI DIVER	.	.	.	.	.	.	.	.	.	.	.	.	.	.	.	.	.	.	.	.	.	.	.	.	.	.	.
NAUTILETTE	.	.	.	.	.	.	.	.	.	.	.	.	.	.	.	.	.	.	.	.	.	.	.	.	.	.	.
NEKTON ALPHA	.	.	.	.	.	.	.	.	.	.	.	.	.	.	.	.	.	.	.	.	.	.	.	.	.	.	.
NEKTON BETA	.	.	.	.	.	.	.	.	.	.	.	.	.	.	.	.	.	.	.	.	.	.	.	.	.	.	.
NEKTON GAMMA	.	.	.	.	.	.	.	.	.	.	.	.	.	.	.	.	.	.	.	.	.	.	.	.	.	.	.
NEMO	.	.	.	.	.	.	.	.	.	.	.	.	.	.	.	.	.	.	.	.	.	.	.	.	.	.	.
NEREID 330	.	.	.	.	.	.	.	.	.	.	.	.	.	.	.	.	.	.	.	.	.	.	.	.	.	.	.
NEREID 700	.	.	.	.	.	.	.	.	.	.	.	.	.	.	.	.	.	.	.	.	.	.	.	.	.	.	.
OPSUB	.	.	.	.	.	.	.	.	.	.	.	.	.	.	.	.	.	.	.	.	.	.	.	.	.	.	.
PAULO 1	.	.	.	.	.	.	.	.	.	.	.	.	.	.	.	.	.	.	.	.	.	.	.	.	.	.	.
PC-3A1	.	.	.	.	.	.	.	.	.	.	.	.	.	.	.	.	.	.	.	.	.	.	.	.	.	.	.
PC-3A2	.	.	.	.	.	.	.	.	.	.	.	.	.	.	.	.	.	.	.	.	.	.	.	.	.	.	.
PC3 X	.	.	.	.	.	.	.	.	.	.	.	.	.	.	.	.	.	.	.	.	.	.	.	.	.	.	.
PC5C	.	.	.	.	.	.	.	.	.	.	.	.	.	.	.	.	.	.	.	.	.	.	.	.	.	.	.
PC 8	.	.	.	.	.	.	.	.	.	.	.	.	.	.	.	.	.	.	.	.	.	.	.	.	.	.	.
PISCES I	.	.	.	.	.	.	.	.	.	.	.	.	.	.	.	.	.	.	.	.	.	.	.	.	.	.	.
PISCES II	.	.	.	.	.	.	.	.	.	.	.	.	.	.	.	.	.	.	.	.	.	.	.	.	.	.	.
PISCES III	.	.	.	.	.	.	.	.	.	.	.	.	.	.	.	.	.	.	.	.	.	.	.	.	.	.	.
PISCES IV	.	.	.	.	.	.	.	.	.	.	.	.	.	.	.	.	.	.	.	.	.	.	.	.	.	.	.
PISCES V	.	.	.	.	.	.	.	.	.	.	.	.	.	.	.	.	.	.	.	.	.	.	.	.	.	.	.
PISCES VI	.	.	.	.	.	.	.	.	.	.	.	.	.	.	.	.	.	.	.	.	.	.	.	.	.	.	.
SOL-I	.	.	.	.	.	.	.	.	.	.	.	.	.	.	.	.	.	.	.	.	.	.	.	.	.	.	.
SEA CLIFF	.	.	.	.	.	.	.	.	.	.	.	.	.	.	.	.	.	.	.	.	.	.	.	.	.	.	.
SEA LINK	.	.	.	.	.	.	.	.	.	.	.	.	.	.	.	.	.	.	.	.	.	.	.	.	.	.	.
SEA OTTER	.	.	.	.	.	.	.	.	.	.	.	.	.	.	.	.	.	.	.	.	.	.	.	.	.	.	.
SEA RAY	.	.	.	.	.	.	.	.	.	.	.	.	.	.	.	.	.	.	.	.	.	.	.	.	.	.	.
SEA RANGER	.	.	.	.	.	.	.	.	.	.	.	.	.	.	.	.	.	.	.	.	.	.	.	.	.	.	.
SHELF DIVER	.	.	.	.	.	.	.	.	.	.	.	.	.	.	.	.	.	.	.	.	.	.	.	.	.	.	.
SHINKAI	.	.	.	.	.	.	.	.	.	.	.	.	.	.	.	.	.	.	.	.	.	.	.	.	.	.	.
SNOOPER	.	.	.	.	.	.	.	.	.	.	.	.	.	.	.	.	.	.	.	.	.	.	.	.	.	.	.
SP 350	.	.	.	.	.	.	.	.	.	.	.	.	.	.	.	.	.	.	.	.	.	.	.	.	.	.	.
SP 500	.	.	.	.	.	.	.	.	.	.	.	.	.	.	.	.	.	.	.	.	.	.	.	.	.	.	.
SP 500	.	.	.	.	.	.	.	.	.	.	.	.	.	.	.	.	.	.	.	.	.	.	.	.	.	.	.
SP 3000	.	.	.	.	.	.	.	.	.	.	.	.	.	.	.	.	.	.	.	.	.	.	.	.	.	.	.
SPORTSMAN 300	.	.	.	.	.	.	.	.	.	.	.	.	.	.	.	.	.	.	.	.	.	.	.	.	.	.	.
SPORTSMAN 600	.	.	.	.	.	.	.	.	.	.	.	.	.	.	.	.	.	.	.	.	.	.	.	.	.	.	.
STAR I	.	.	.	.	.	.	.	.	.	.	.	.	.	.	.	.	.	.	.	.	.	.	.	.	.	.	.
STAR II	.	.	.	.	.	.	.	.	.	.	.	.	.	.	.	.	.	.	.	.	.	.	.	.	.	.	.
STAR III	.	.	.	.	.	.	.	.	.	.	.	.	.	.	.	.	.	.	.	.	.	.	.	.	.	.	.
SUBMANAUT (Helle)	.	.	.	.	.	.	.	.	.	.	.	.	.	.	.	.	.	.	.	.	.	.	.	.	.	.	.
SUBMANAUT	.	.	.	.	.	.	.	.	.	.	.	.	.	.	.	.	.	.	.	.	.	.	.	.	.	.	.
SUBMARAY	.	.	.	.	.	.	.	.	.	.	.	.	.	.	.	.	.	.	.	.	.	.	.	.	.	.	.
SURV	.	.	.	.	.	.	.	.	.	.	.	.	.	.	.	.	.	.	.	.	.	.	.	.	.	.	.
SURVEY SUB	.	.	.	.	.	.	.	.	.	.	.	.	.	.	.	.	.	.	.	.	.	.	.	.	.	.	.
TECHDIVER	.	.	.	.	.	.	.	.	.	.	.	.	.	.	.	.	.	.	.	.	.	.	.	.	.	.	.
TOURS	.	.	.	.	.	.	.	.	.	.	.	.	.	.	.	.	.	.	.	.	.	.	.	.	.	.	.
TOURS	.	.	.	.	.	.	.	.	.	.	.	.	.	.	.	.	.	.	.	.	.	.	.	.	.	.	.
TRIESTE	.	.	.	.	.	.	.	.	.	.	.	.	.	.	.	.	.	.	.	.	.	.	.	.	.	.	.
TREISTE II	.	.	.	.	.	.	.	.	.	.	.	.	.	.	.	.	.	.	.	.	.	.	.	.	.	.	.

**TABLE 14.1 SUBMERSIBLE EMERGENCY SYSTEMS AND DEVICES (Cont.)**

	Auto matic	Echo Sound er	Obsta cle Avoid Sonar	Atmos Moni tors	Man ual Weight Drop	Trim Equip Blow	High Pres Blow	Hull Person Release	Releas Cap	Closed Submgd Inflata Breath ers	Scuba Port able	Bot tom Mount UOC	Ra Flash dio Light	Rock ets and Flares	Inflat Hatch Trunk	Sur face Inflat Bags	Sur face Snor kel	Mark er	Under Water Buoy	Trans ponder	Ping er	External Connections Gas Air Elec Rats
TUDLIK (PS 2)	.	.	.	.	.	.	.	.	.	.	.	.	.	.	.	.	.	.	.	.	.	.
TURTLE	.	.	.	.	.	.	.	.	.	.	.	.	.	.	.	.	.	.	.	.	.	.
VAST MK II (K 250)	.	.	.	.	.	.	.	.	.	.	.	.	.	.	.	.	.	.	.	.	.	.
VIPER FISH	.	.	.	.	.	.	.	.	.	.	.	.	.	.	.	.	.	.	.	.	.	.
VOL LI	.	.	.	.	.	.	.	.	.	.	.	.	.	.	.	.	.	.	.	.	.	.
YOMIURI	.	.	.	.	.	.	.	.	.	.	.	.	.	.	.	.	.	.	.	.	.	.

**TABLE 14.2 EMERGENCY AVOIDANCE SYSTEMS**

Contingency	Avoidance Systems
Exceeding Operational Depth	Depth Gage Automatic Deballasting Devices: Weight Drop Ballast Blow Surface Buoy
Impact With Bottom	Echo Sounder
Obstacles To Maneuvering	Obstacle Avoidance Sonar
Life Support Failures	Atmospheric Monitoring Devices
Deteriorating Surface Conditions Surface Traffic	Underwater Telephone
Separation From Surface Ship	Pinger Transponder Underwater Telephone Surface Buoy
Faulty Life Support	Monitors: O <sub>2</sub> , CO <sub>2</sub> , Pressure (Cabin), CO, Trace Contaminants

deal of the operational problems which accompany submersibles; the latter, if employed, is the best asset the operator has to avoid situations wherein emergency measures must be executed. Assisting the operator are a number of devices to counteract potential emergencies; these will be discussed briefly under the nature of the emergency. In some instances one instrument may serve to avoid or counteract more than

one kind of emergency: Thus the apparent duplication in Tables 14.2 through 14.4.

**Exceeding Operational Depth**

**Depth Gages:**

Pressure-sensitive depth gages are available with accuracies up to ±0.05 percent of full scale range. Most submersibles include a safety factor of 1.5 on all pressure-resistant

**TABLE 14.3 EMERGENCY CORRECTIVE SYSTEMS (SUBMERGED)**

Emergency	Corrective Systems
Loss of Normal Surfacing Ability	Weight Drop Hand Pump Deballasting Trim Fluid Dump Equipment Jettison High Pressure Deballasting Pressure Hull Release Personnel Egress Releaseable Personnel Capsule Inflatable Bag
Entanglement	Equipment Jettison Pressure Hull Release Releaseable Personnel Capsule Personnel Egress Emergency/Normal Ascent Procedure
Pressure Hull Flooding	Emergency/Normal Ascent Procedures High Pressure Air Blow or Pump
Fire	Fire Extinguisher
Elimination of Noxious/Toxic Gasses	Emergency Breathers Emergency/Normal Ascent Procedures
Loss of Normal Life Support	Closed Circuit Breathers Open Circuit Breathers Chlorate Candles Emergency/Normal Ascent Procedures
Loss of Electrical Power	Emergency (Internal) Batteries Automatic Weight Drop (Fail-Safe) Flashlights Non-Electrical Ascent

**TABLE 14.4 EMERGENCY CORRECTIVE/ASSISTANCE SYSTEMS (SURFACED)**

Emergency	Instruments
Separated from Support Craft	Radio Underwater Telephone Flashing Light Radio Signal Distress Rockets Flares Anchor
Breathing Gasses Expired	Open Hatch (Sail Allowing) Inflatable Trunk Around Hatch Inflatable Bags (Increase Freeboard) Snorkel External Gas Replenishment Connections

components. In this situation the inaccuracy of the depth gage is more than offset by the liberal safety factor. For example, if a vehicle's operating depth is 1,000 feet, a safety factor of 1.5 allows 1,500 feet before reaching collapse depth. At 1,000 feet a pressure gage reading within  $\pm 50$  feet of that depth is well within the vehicle's ability, not only to survive, but to function routinely.

**Automatic Deballasting Devices:**

Two procedures are incorporated on several submersibles which automatically function to provide positive buoyancy if it proceeds beyond operational depth. One system (*DS-4000*) automatically drops a weight beyond 4,400 feet; on *STAR III* the same procedure is available, but only if the high pressure air system (used to deballast the main ballast tanks) falls below a critical pressure level (185 psi below ambient pressure). In other vehicles (*BEN FRANKLIN*, *SHINKAI*, *MERMAID I/II* and the *TOURS* series) a pressure sensing device activates blowing the main ballast tanks if the vehicle journeys below operational depth. The remaining submersibles with automatic deballasting in Table 14.1 drop iron shot when electrical power fails regardless of depth. The *TOURS* vehicles constitute a special case whereby

automatic deballasting occurs not only below operating depth, but every 13 minutes at any depth unless the operator takes preventative action. The drawbacks of such systems are: 1) They are governed by the accuracy of the activating mechanism's sensing device; and 2) they do not take into consideration all possible operating situations. Let us imagine that *DEEPSTAR 4000*, for example, is working at its operational depth underneath an overhanging cliff or cable and inadvertently exceeds 4,000 feet. Automatic deballasting might send it up into the very hazard it wished to avoid. The timed deballasting in the *TOURS* vehicle opens the door for greater susceptibility to overhead hazards and untimely surfacing and detracts from operator efficiency because he must now concentrate not only on the job at hand, but keep track of time as well.

**Buoys:**

In the early days of submersibles it was considered a safe practice to tie a large buoy on the vehicle with a length of line that would, in addition to facilitating tracking, prohibit the vehicle from exceeding its operational depth. The pitfalls of this practice became evident before the safety line inextricably snarled on an obstruction and

trapped the vehicle below. One major advantage that submersibles—like the scuba diver—enjoy is maneuverability. To restrict this maneuverability may place it in greater jeopardy than is the chance of going below operational depth. It should be noted, however, that the Japanese *KUROSHIO I & II* have conducted safe dives for well over a decade with a power cable tethered to a surface ship. Undoubtedly, this safety record is the result of careful planning and investigation of the dive sites to assure that nothing is present to foul the cable.

### Impact With Bottom

Owing to the inherent inaccuracies in depth gages and precise depth values at the dive site, many vehicles include a device which informs the operator of his distance off the bottom. In addition to supplying data useful to performance of missions, such devices afford the operator the opportunity to avoid striking the bottom on descent and damaging critical components. Conventional echo sounders serve this purpose and include

a transducer mounted on the vehicle's keel and a depth display device in the pressure hull. The internal display is either a strip chart recorder or a flashing light. Either display is adequate, but the strip chart provides a permanent record which is invaluable to various surveying or research tasks. Regardless of the sensing device employed, one may expect some inadvertent contact with the bottom as the underside of *DS-4000* (Fig. 14.1) testifies.

### Obstacles to Maneuvering

Underwater visibility may range from several hundred feet (Fig. 14.2) to a few feet—the former being common to shallow tropic and sub-tropic waters and in the arctic and antarctic, while the latter is found throughout the estuarine, coastal and open ocean temperate waters. The lack of usable ambient light for visual observations below a few hundred feet requires artificial lighting. This may provide 50 to 70 feet of viewing distance, depending on water clarity. Consequently, many submersibles carry a sonic



Fig 14.1 Scratches on the underside of *DEEPSTAR 4000* testify to the frequency of inadvertent bottoming in submersibles (NAVOCEANO)





Fig. 14.2 Unusually long range visibility is shown from this camera and a line of targets, 4-liter bottles spaced 10 feet apart, photographed at a depth of 600 feet under ambient light off Key West Florida from STAR III. The depth of field exceeds 100 feet and horizontal visibility was estimated at over 200 feet. (NAVOCEANO)

device to warn of obstacles in their line of flight—*e.g.*, cliffs, wrecks, cables, etc.—beyond the limits of visibility. Two approaches to obstacle avoidance have been taken: The first incorporates a conventional echo sounder transducer mounted on the bow and looking directly forward; the second involves a horizontally trainable transducer mounted forward and atop the vehicle which operates similar to radar and displays targets on a cathode ray tube scope inside the vehicle and which provides range and relative bearing of a target from the submersible (Fig. 14.3). A number of companies produce this latter system. The Straza Model 500 CTFM Sonar is on several submersibles and its range is from 10

to 1,500 yards. Both the forward-looking echo sounder and the CTFM have served admirably; the characteristics of these are discussed in Chapter 10. From a safety viewpoint, none have demonstrated an advantage over the other.

### Life Support Monitors

Most, but not all, submersibles carry automatic or manual devices to measure pressure hull oxygen and carbon dioxide content. The manual devices are easily obtainable off-the-shelf instruments, the automatic devices are also stock items but more expensive. The general practice is to take or observe cabin oxygen and carbon dioxide content at peri-



Fig 14.3 ALUMINAUT's CTFM sonar traces of a box canyon at 800 feet deep off Vieques Island, Puerto Rico. (NAVOCEANO)

odic intervals. No reported emergencies have evolved through this procedure in the history of submersible diving. Most submersibles do not dive for much longer than 8 hours, which may account for this high safety record. On long duration dives, *e.g.*, **BEN FRANKLIN's** 30-day Gulf Stream Drift, automatic monitoring and warning devices may be more advantageous in view of operator fatigue or involvement with other duties. Included within the life support monitoring devices on several submersibles are those which measure internal pressure and trace contaminants. An aircraft altimeter or barometer is quite often used to serve the first function, and portable testing kits are available to measure trace contaminants.

### Surface Traffic and Inclement Weather

It is impossible for the submersible's pilot to assess surface traffic conditions prior to surfacing. In the open sea the chance of surfacing under or within the path of an oncoming vessel is quite slim, but in waterways or coastal traffic lanes it is considerable. While an upward viewing capability in the submersible might exist, it is not always possible to stop the submersible during ascent and lack of water clarity might preclude

visual observations. Surface weather conditions can deteriorate during a 6- to 8-hour dive and generate a sea state in excess of that considered safe for retrieval. Some ocean areas, the Santa Barbara Channel for example, are subject to rapid weather changes which can close in on a dive site with little advance notice. The only safeguard against both potential hazards (traffic and sea state) is a surface tending craft capable of communication with the submersible. As a general operating procedure, the surface vessel has the ultimate control regarding safe and timely surfacing. Though the likelihood of collision with a military submarine or another submersible is slim, communication between two underwater vehicles may be carried out providing the frequencies of both telephones are the same. There is no standard frequency for underwater telephones, and they have ranged from 8 kHz to 100 kHz. Purely by chance, 8.0875 kHz is found on a great number of vehicles. This is the frequency selected for the first Naval underwater telephone and designated as AN/UQC and is used on U.S. Navy submarines. The reason for the choice of 8 kHz on small submersibles is simply that it was all that was commercially available in the fifties and early sixties. Now, a number of different models and frequencies are available and can be found on various submersibles. From a safety/rescue point of view, it is advisable that the operator includes a carrier frequency of 8.0875 kHz because it is compatible with the majority of his sister vehicles and all U.S. Naval potential rescuers.

### Separation From Surface Ship

For a number of reasons (retrieval, surfacing, rescue) the surface support craft must know the submersible's position relative to itself. Several methods are available and are discussed at length in Chapter 10.

#### Pingers:

Self-powered acoustic pingers may be mounted on top of the vehicle which emit an acoustic impulse every 2 seconds or less. With a frequency compatible listening device (hydrophone) the surface ship stays over the submersible during its dive by assessing the strength of the incoming signal. By carrying

an appropriate hydrophone, the support craft may also determine the submersible's bearing relative to itself and may elect to lay off from the vehicle rather than stay directly overhead.

#### **Transponder:**

Attached to the submersible's topside, the transponder is an automated receiver/transmitter which transmits an acoustic signal when interrogated by the surface craft. By accurately timing the interval between the outgoing and incoming signals, the 2-way slant range between support ship and submersible can be computed, and, by knowing the submersible's depth, the horizontal distance from one to the other may be derived. By increasing or decreasing this distance, the support craft can maintain its desired position relative to the submersible.

#### **Underwater Telephone:**

The submersible's underwater telephone can function as a transponder when a "mark" signal from the surface is answered by "mark" from the submersible. By timing the interval between the surface mark and sub-surface return mark the slant range is calculated. Similarly, by transmitting periodic impulses the telephone may function as a pinger.

#### **Buoys:**

The towing of a surface buoy has been discussed previously. It is sufficient to note that some shallow vehicles are tracked from the surface by towing a surface float.

## **EMERGENCY CORRECTIVE SYSTEMS (SUBMERGED)**

In the event of a submerged emergency, the operator may have several options. The nature of different emergencies and the various options are shown in Table 14.3 and discussed below.

#### **Loss of Normal Surfacing Ability**

Submersibles surface through a variety of procedures: They may power up, drop weights or blow ballast. In the event that none of the normal procedures operate, other options are available to the occupants for

regaining the surface either with or without the submersible.

#### **Weight Drop:**

The most widespread emergency surfacing procedure is the dropping of a lead or steel weight attached to the submersible's keel (Fig. 14.4). Depending on the submersible,

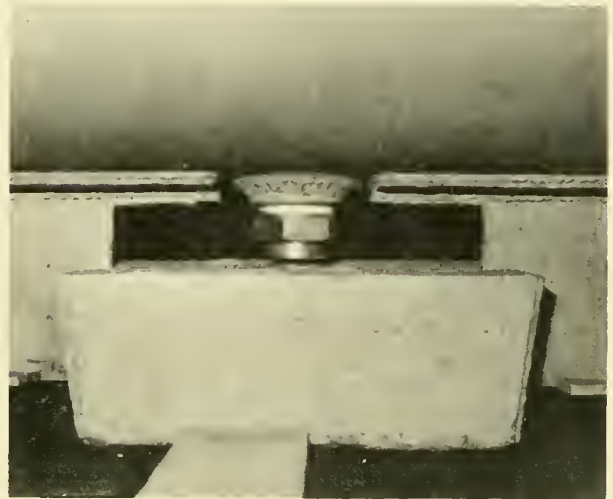

Fig. 14.4 The 200-lb lead weight (top) on *SEA OTTER*'s keel is manually dropped by a "T" bar wrench (bottom) from in the hull. Both ends of the weight are recessed and indexed into the keel to assure it will not rotate while being unscrewed

the weight will vary, but the method of jettisoning is either by mechanically turning a thru-hull releasing shaft or by electrically or hydraulically actuating a release mechanism. In the latter procedure the electrical power is derived from emergency batteries within the pressure hull. In some cases an electrically-actuated (explosive) device may serve as the release mechanism by cutting a restraining cable or the like.

#### Equipment Jettison:

To attain the same results as a weight drop, equipment such as batteries, mechanical arms, motors and the like can be jettisoned to lighten the vehicle. This procedure is generally secondary to a weight drop because of the high cost of such equipment.

#### Trim Fluid Drop:

Those submersibles which use mercury to attain bow trim (pitch) angles or roll (list) angles also incorporate a method of dumping the mercury *in extremis*. In the event that the submersible rests at such an angle that a gravity dump is not effective, it may—as does **DEEPSTAR 4000**—carry a reservoir of compressed nitrogen which can force the mercury out of the reservoir. In consideration of the pollution aspects of mercury, the U.S. Navy is presently working on an alternative to mercury as a trim fluid and has, for the interim, made mercury dumping from its vehicles impossible.

#### High Pressure Ballast Tank Blow:

Submersibles' main ballast tanks are used to achieve surface freeboard and are emptied of water by compressed air. Consequently, low pressure air is all that is required for blowing ballast on the surface. As an emergency feature, in addition to normal variable ballast tank control, a number of vehicles carry high pressure air to blow the main ballast tanks empty and lighten the vehicle for surfacing from operating depth. This is a common emergency feature on the shallow-diving submersibles and is found on some of the deeper vehicles (e.g., **ALUMINAUT**).

#### Manual Deballasting:

As a backup to the above deballasting procedure, a few vehicles include a hand pump in the pressure hull which can be used

to evacuate water from the ballast tanks if the air blow system malfunctions.

#### Personnel Egress:

More than a third of past and present submersibles incorporate procedures to allow the occupants to exit the vehicle when all else fails to bring it to the surface. In theory the procedures are simple and fall into two categories: 1) Pressurizing the hull with compressed air from the ballast blow tanks until internal air pressure equals ambient water pressure, which allows the occupants to open the hatch, flood the hull, leave and ascend to the surface; and 2) opening a thru-hull valve to allow seawater into the hull until it compresses the air in the hull to a point where it (the air) is equal to ambient pressure and allows the occupants to open the hatch and swim to the surface (in some vehicles both systems may be used concurrently). In lock-out submersibles the egress hatch is in the bottom of the vehicle and it is not necessary to flood the hull for exiting when internal pressure is equal to ambient (Fig. 14.5).



Fig. 14.5 Divers approaching the lock-out hatch of **BEAVER**. Air pressure in the aft sphere is equal to water pressure and prohibits entrance of seawater. (North American Rockwell)

Whatever the procedure followed, the successful practitioner must maintain exceptional calm as his haven fills with water and he contemplates a swim to the surface. The disadvantages of this procedure are decompression sickness, nitrogen narcosis, oxygen poisoning, cold and panic. Successful systems must offer quick pressurization, simplicity, protection from cold water and a buoyancy device to assist ascent.

The British Royal Navy has developed buoyant ascent escape techniques to the point where test escapes from a military submarine have been accomplished from 600 feet deep. Commander M. R. Todd, R.N., (1) estimates that 740 feet is certainly attainable, and deeper than this is a likelihood. Because it is the most successful and advanced personnel escape system in the world, wherein the occupants enter the water, Todd's description of the British system (Fig. 14.6) may serve as a basis for comparison against the systems used in submersibles.

*“It (the escape system) consists of a Single Escape Tower at both ends of the submarine, each fitted with the Hood Inflation System (HIS) and used in conjunction with the Submarine Escape Immersion Suite Mark 6 or 7. The Escaper enters the tower through the lower hatch and connects his suit to the Hood Inflation System with a simple push-in plug. Through this he receives pure air at 1 psi above ambient. The lower hatch is then shut and the tower is flooded from the sea. (The last man can complete these actions by himself). The pressure in the tower is then doubled every 4 to 16 atms in 16 seconds. The tower is calibrated to achieve this pressurization rate at any depth without adjustment or action by the escapers. During this phase of the escape cycle the HIS supplies air at 1 psi more than ambient, first inflating the stole, or lifejacket, built into the suit, and then, through two 1/2 psi relief valves, the hood. However fast the pressure builds up in the tower the hood remains inflated to provide the escaper with a comfortable air lock from which to fill his lungs. Without thought or action he gets as much air as he needs and*

*only wastes the slight overflow from the open bottom of the hood.*

*When the tower pressure equals that of the sea, the upper hatch opens. Because this is all that has been keeping the escaper in the tower, he starts his ascent and the air connection disengages, both parts sealing automatically as they separate. Bottom time is under three seconds. The ascent is completed at 8.5 feet per second and the escaper breathes normally all the way. By doing this he ensures that his lungs are at the same pressure as that in the hood and therefore the sea, because the hood is open at the bottom.*

*On arrival at the surface the hood is removed and the suit starts its next task of protecting the escaper from exposure or drowning.”*

—Todd (1)

Now, let us look at the escape procedures for two manned submersibles, **BEN FRANKLIN** and **STAR III**.

a) **BEN FRANKLIN:**

This escape procedure assumes that any escape will involve depths where decompression times will extend beyond the endurance of the Draeger FGG III. This procedure further assumes that a Personnel Transfer Capsule (see the SRC in Chap. 15) will be ready to accept escaping personnel in the immediate vicinity of the after hatch.

1. Rig hatch skirt.
2. Make decision on use of life raft.
3. Turn on all battery powered lanterns.
4. Conduct final surface communications.
5. Place mode switch in zero mode (OFF).
6. All hands don life vests.
7. All hands don breathing rigs.
8. Remove all main power fuses.
9. Short exterior fuse clips to blow exterior fuses.
10. Undog after hatch.
11. Flood boat as fast as possible via variable ballast tank inboard vents and SAS vent. Secure flooding when water level is just about skirt lip. All



Fig 14.6 The Royal Navy's Hood Inflation System and Submarine Immersion Suit Mark 7. (K R Haigh, A.U.W.E.)

hands must be on breathing rig at the start of flooding. Use of Plankton Sampler can vastly speed flooding.

12. Release guide line.
13. Await signal from PTC before attempting to exit.
14. Upon signal from PTC, exit and swim or follow line to the PTC. Be prepared to ditch gear before entering PTC if requested by the PTC escort.

In the event that the signal under item 13 may not be readily communicated by the PTC escort, he may elect to make a series of three taps in quick succession repeated at intervals as necessary to assure receipt will constitute an exit instruction.

—Gulf Stream Drift Mission Plan,  
May, 1969

#### b) **STAR III:**

The procedure is based upon escape from a maximum of 300 feet. All tables and times are based on this depth.

The submersible occupants will notify topside when the oxygen pressure gage reads 100 psi. This shows that there is 1 hour of oxygen life support left. Topside will make ready, standing by with personnel at lookout stations and divers and gear ready to assist the submersible occupants when they reach the surface.

The submersible occupants will make use of the following items: Each occupant will don a Navy-type emergency ascent **Steinkie Hood**, but will not place the hood over his head.

Emergency breathing regulators will be made ready before the start of flooding the sphere.

The air line (a flexible hose and valve to inflate life vests as the sphere is being flooded) will be made ready. Face masks will be made ready to use prior to flooding. The hatch handle removal gear used to push out the hatch handle shaft, underwater flashlights, and all other tools necessary to remove existing gear will be available to the pilot.

After all gear is ready, the following emergency procedure will be carried out:

1. A briefing to the observer on how to make the emergency escape.
2. Make final communications with top-

side informing them that you are ready to start emergency escape procedures to flood the sphere.

3. Remove the hatch dogging gear and install hatch shaft pin removal gear.
4. Secure all electrical power and remove electrical power emergency E.O. plug. (This eliminates all electrical power to the sphere.)
5. The air hose to inflate hoods shall be readily available to the pilot.
6. Don **Steinkie Hood** and pressurize units for breathing.
7. Open the water sampling line on the sea manifold to start flooding.
8. Remove hatch shaft pin using removal gear. When the pin is removed and water starts to enter, both pilot and observer will position themselves in a sitting position during flooding. An underwater light will be strapped to each occupant.
9. In the first minute during flooding, the sphere will change pressure by 1 atmosphere, (33 ft = 14.7 psi + the original atmosphere in the sphere before flooding, totalling approximately 29 psi). Approximate time to fully flood sphere is about 4 minutes.

NOTE: As pressure in the sphere builds up, the pilot and observer must replenish air to the **Steinkie Hoods**. The hoods would be completely deflated after an external pressure of 45 psi. The pressure to the hoods must be maintained to permit proper breathing.

10. The pilot and observer will maintain physical contact at all times.

When the sphere is full enough to permit the pilot to open the hatch, he will do so and he will then open the sail hatch. The observer will exit first, when he is outside the submersible, he will grab hold of the handrail and wait for the pilot to exit. Before the pilot and observer start their ascent to the surface, they will fully inhale, fully exhale, and on the fully exhale they will let go of the handrail and, keeping their lungs as deflated as possible, keep shouting HO-HO-HO all the way to the surface.

—**STAR III** Operations Manual, Jan. 1968

One point emphasized in both the *BEN FRANKLIN* and *STAR III* emergency procedures is that personnel egress is the very last option and should not be attempted until all other options have proven futile. This warning is for very sound reasons and is based on the fact that the decision to flood and exit the submersible opens the door for a

variety of fatal potentials in which decompression sickness, nitrogen narcosis and drowning predominate. The *STAR III* manual presents the graph shown in Figure 14.7 which is the time it would take to flood the pressure sphere to the point where the internal air pressure equals ambient water pressure. This time (bottom time) is critical for

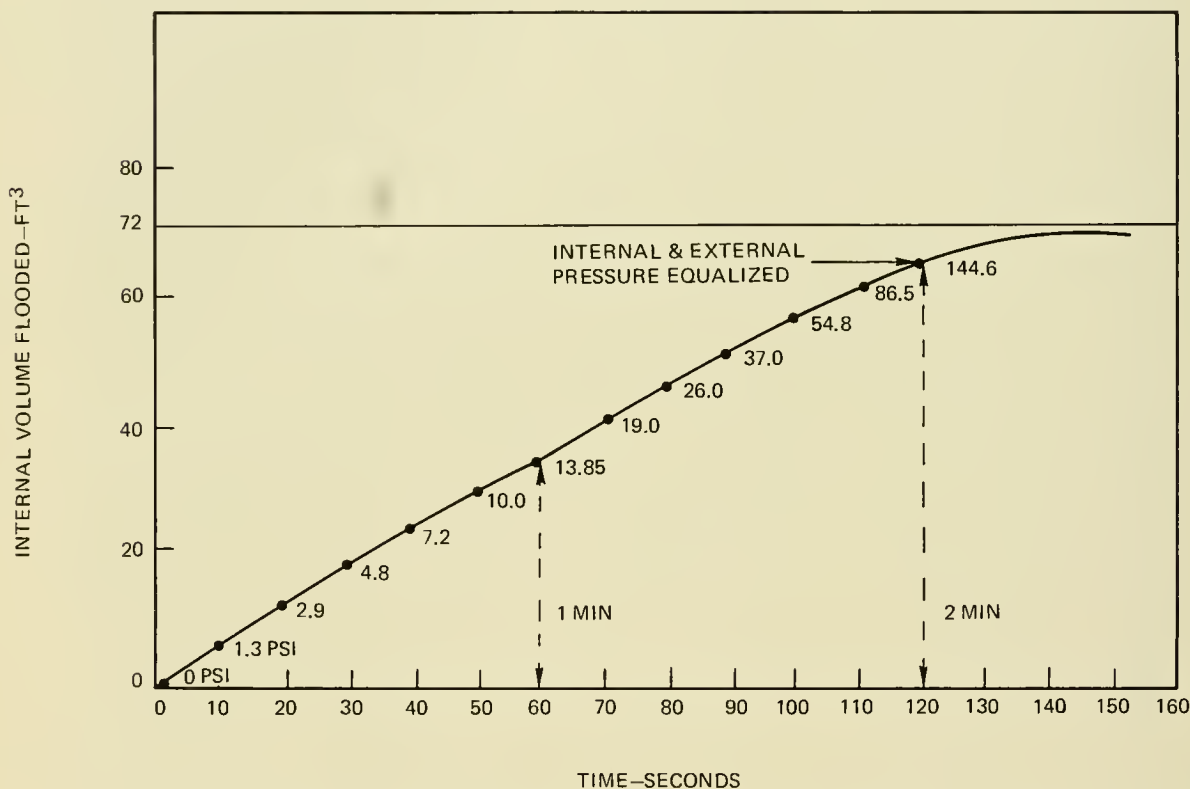

Fig. 14.7 Curve showing the time it would take to flood STAR III's 5.5-ft ID hull and pressure within the hull as a function of time at 300 feet deep through a 3/4-inch-diameter hole.



decompression and extending it beyond specified time limits (see U.S. Navy Diving Manual) at specific depths can be fatal to the occupants if decompression facilities are not available. The British system owes its success to short bottom time, extreme simplicity and protection from cold, among other things. The procedures from manned submersibles offer few, if any, of these advantages. For this reason, leaving the submersible is a last resort.

#### Pressure Hull Release:

The U.S. Navy submersibles *ALVIN*, *SEA CLIFF*, *TURTLE* and *MAKAKAI* are so constructed that the pressure hull (sphere) may be mechanically disengaged from the exostructure and, by virtue of its positive buoyancy, carry the occupants to the surface. The principle of operation is similar in all of these vehicles, and the description of *ALVIN*'s release mechanism (Mavor *et al.* (2)) is representative. *ALVIN* was designed in two sections, the forebody and the afterbody. The forebody includes the personnel sphere, the conning tower, the main ballast system, an emergency battery supply and all the life-support equipment. It is buoyant by some 800-900 pounds. The remainder of the vehicle comprises the afterbody.

The frame of the afterbody was designed to protrude underneath the pressure hull and provide a cradle for it. When in "neutral trim," the afterbody is negatively buoyant by the same amount that the forebody is positively buoyant. A mechanical release mechanism holds the two sections together and is in tension when submerged. On deck the mechanism is relaxed and the forebody rests in the cradle of the afterbody.

The release mechanism consists of a shaft, a seal assembly, two spring-loaded dogs and two hooks. The dogs are part of the afterbody and the hooks are rigidly attached to the pressure hull. The shaft penetrates the pressure hull on bottom dead center. When the shaft is turned with a suitable wrench it rotates a cam which, at one-quarter turn allows the dogs to come together and disengage the hooks. The forebody is then free to rise to the surface with the occupants (Fig. 14.8).

The position of the sphere upon reaching the surface is speculative. Shallow water

tests (18 ft) under controlled conditions were conducted and *ALVIN*'s sphere reached the surface with the sail up and the hatch could have been opened by the occupants without flooding, but from a 12,000-foot ascent, the drag on the sail could produce a surfaced stable condition with the hatch down.

#### Releasable Capsule:

Similar in effect to *ALVIN*'s releasable pressure hull are the releasable spheres on the uncompleted French *ARGYRONETE* and the Japanese *SHINKAI*. Atop *ARGYRONETE*'s hull and over the main hatch is a 2.28-meter-diameter steel sphere capable of accommodating the entire crew of 10 (Fig. 14.9). Once the occupants are inside, the sphere is released by them to rise to the surface. In *ARGYRONETE* an inflatable trunk surrounds the sphere hatch and affords protection from the sea.

#### Inflatable Bag:

Two submersibles (*PC5C* and *TECH-DIVER*) offer as optional features emergency bags external to the hull and inflatable by carbon dioxide. These bags may be inflated automatically or manually. In *TECHDIVER* the bag capacity is 40 cubic feet.

### Entanglement

The methods available to the submersible operator in the event of entanglement depend upon the nature of the object fouled. If

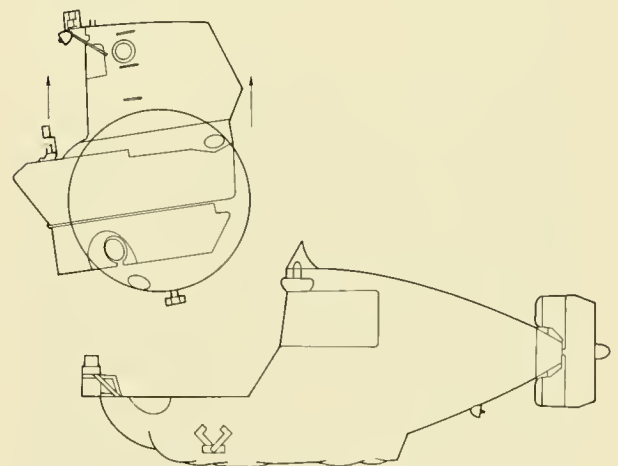

Fig 14.8 Emergency release of *ALVIN*'s personnel sphere.

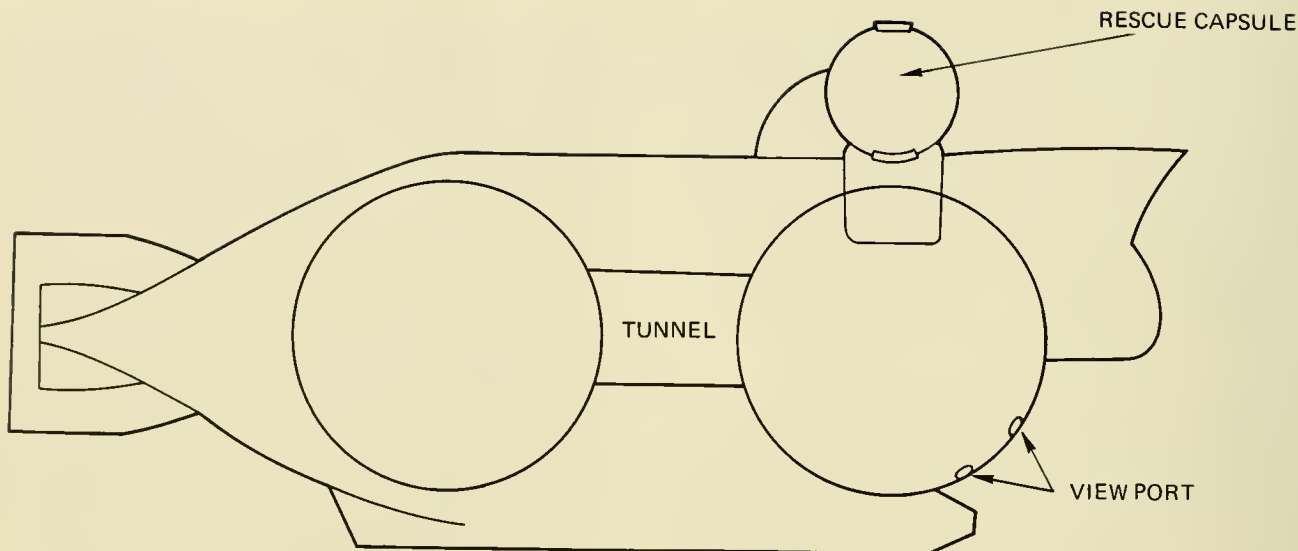

Fig. 14.9 Schematic of the Japanese submersible SHINKAI showing location of releasable rescue capsule.

the entangled object is light enough to be carried to the surface, then the vehicle's normal or emergency deballasting procedures may be used. If this is not the case, then the procedures under Loss of Normal Surfacing Ability must be employed, *i.e.*, jettison the fouled component, release the pressure hull or emergency capsule or egress the vehicle. In addition, if life support endurance is sufficient, assistance from the surface craft or other submersibles is also included in the arsenal of emergency procedures. The first line of defense against entanglement is a smoothly faired vehicle. If there must be items which could snag objects they should be jettisonable.

### Flooding

Flooding of a submersible may occur in compartments, other than the pressure hull, which are also critical to safety. Critical compartments are the battery pods, main and variable ballast tanks and motor and other component housings. Detection of flooding is accomplished, for example, by installing self-powered twin electrode systems that set off an alarm when seawater completes the circuit between the electrodes. On the Perry-built submersibles such sensors are located fore and aft in the battery pods and consist of twin electrodes mounted within a polyvi-

nyl chloride (PVC) tube, with each unit being powered by its own 9-volt battery. When flooding occurs both a visual (light) and an audio alarm are activated to inform the pilot. Flooding within the pressure hull is detected visually by the occupants and, in the small confines of submersibles, does not go undetected. Depending on the location, nature and extent of the flooding, the standard procedure is to surface. If flooding of the pressure hull is severe, every emergency deballasting system available may be used to surface and decrease the pressure differential across the leaking area. Several Perry-built boats, to counteract flooding, carry a trim pump within the pressure hull that pumps water out of the hull through an overboard dump valve.

All leaks are not necessarily emergency situations. **BEN FRANKLIN**, for example, took water aboard when drifting between 600 and 700 feet during its entire 30-day drift in the Gulf Stream. The leak was between the housing of an electrical penetrator and the hull and amounted to no more than an occasional drop of seawater. During its deeper (1,500-ft) excursions the increased external pressure squeezed the housing and penetrator together and the leak ceased.

As a flooding control method, **SEA RANGER 600** provides for the introduction

of high pressure air into the pressure hull. This procedure would seem inadvisable unless the submersible can make a very rapid ascent to the surface to relieve internal pressure and avoid decompression sickness. Conversely, too-rapid an ascent might produce an air embolism in the occupants.

## Fire

The principal type of fire anticipated in a submersible is an electrical fire. For this reason, one or several dry chemical type extinguishers are carried; these do not produce large quantities of toxic gasses or vapors and their effect is minimal on adjacent equipment. When such extinguishers are employed the occupants, for additional safety, are advised to don their emergency breathing systems.

## Loss of Normal Life Support/Toxic and Noxious Gasses

In the event that a submersible's life support system fails, or expires, or gasses and fumes evolve which are harmful to the occupants, the response is the same in both cases: Employ the emergency breathing devices and surface as quickly as necessary. There is, as can be expected, a gray area between the time life support fails or noxious gasses are detected and the decision is made to don the emergency equipment. For example, if the blower unit which forces cabin air through a carbon dioxide removal system fails, the submersible may be at a depth where routine surfacing and retrieval can be accomplished before the need of emergency breathing arises. In an actual case, a buildup of carbon monoxide was detected in **BEN FRANKLIN** in the first stages of its 30-day drift mission. Though carbon monoxide is a potentially fatal gas in sufficient concentrations and over a given time period, it was decided that the trip could safely continue until 50-ppm concentration was reached. The decision was correct and allowed completion of the mission with no immediate or long-term effects on the submersible's occupants. On the other hand, the decision may be instantaneously made in the advent of fire, which is the most likely, but not the only source for the evolution of noxious or toxic gasses.

Owing to the availability of instruments to monitor a life support system's performance, its failure or inadequacy is relatively easy to determine. Release of noxious or toxic gasses is not easily measured because they may come from a variety of different sources. For example, when exposed to the atmosphere, many of the following may lose solvents, plasticizers and unpolymerized materials by volatilization:

- Surface coatings
- Cords of synthetic or natural fibers
- Plastic films
- Molded and cast plastics
- Wire insulation
- Thermal insulation
- Adhesives
- Electronic encapsulation compounds
- Silicones and organic lubricants and fluids
- Metallic dust and oxides
- Casting compounds
- Ozone-emitting electronic and electrical equipment
- Tapes

A direct and visible source of contamination is from strip chart recorders (*e.g.*, echo sounders) that burn an imprint on a chemically treated paper to record data. The chemical composition of the by-product's fumes may be unattainable because the paper manufacturer considers the recording paper's composition proprietary.

A variety of emergency breathing systems are used in submersibles, but they basically fall into two categories: Open circuit and closed circuit.

### Open-Circuit Breathing:

These systems are termed open-circuit because the occupants inhale directly from the gas supply and each breath is exhaled into the surrounding atmosphere. The majority of submersibles employ some variety of open-circuit emergency breathing modified from scuba. The system may consist of: 1) A mouthpiece and pressure regulator connected by high pressure tubing to the vehicle's low or high pressure ballast-blowing air supply, or 2) the same components connected to either portable or non-portable tanks of compressed air. Exception is found where the mouthpiece, regulator and hose are con-

nected to non-portable tanks within the pressure hull filled with compressed oxygen. Both the portable or non-portable systems offer the advantages of being simple to operate, reliable and relatively inexpensive. Eye protection is afforded by face masks. The disadvantage to the open-circuit system is that the exhaled gasses may build up cabin pressure to a point where decompression becomes a consideration.

#### **Closed-Circuit Breathing:**

In a closed-circuit system the occupants inhale from a breathing bag and exhale each breath back to the breathing bag through a purifying cannister. Closed-circuit systems consist fundamentally of an oxygen supply, regulator, gas metering device, breathing bag, mouthpiece or mask, carbon dioxide absorption cannister and breathing hose. Two

systems used in submersibles are the Westinghouse Corp.'s Min-O'Lung (Fig. 14.10) and The Mine Safety Appliance's U.S. Navy Mark II. Both use 100 percent oxygen and are lightweight and simple to use. In addition to these advantages, the closed-circuit system does not increase cabin pressure because the used air is recirculated back into the system. A disadvantage, however, lies in the toxicity of oxygen under pressure. Though the submersible's cabin pressure is generally held at atmospheric, a doubling of this pressure (29.4 psia) allows less than 40 minutes of breathing before the danger of toxicity occurs. In most submersibles the pressure-toxicity potential level is unlikely to be reached because the vehicle will be at or near atmospheric pressure and, with the donning of the closed-circuit system there is no further introduction of gasses (pressure)



Fig 14.10 The Westinghouse Min-O'Lung (left) and Drager (right) emergency breathing systems. Both have about 0.5 hours endurance. (Westinghouse Corp.)

into the hull. However, in a lock-out vehicle where the divers may be at cabin pressure in excess of 29.4 psia, the oxygen closed-circuit system is a definite hazard. For this reason none of the lock-out submersibles covered herein employs an oxygen closed-circuit system for emergency breathing.

The duration of an emergency breathing system is difficult to pre-determine. The closed-circuit systems may supply sufficient oxygen for 1 to 4 man-hours of breathing. The key, however, is the user and his activity. In an emergency the average person's respiration will increase and the emergency breathing gasses will expire much sooner than under non-stress conditions. Other factors which will increase rate of gas consumption are cold and physical exertion. The ideal situation in an emergency is for the occupants to remain calm and breathe at a slow, even rate to conserve their air. Some individuals are capable of controlling themselves under times of stress; others are not. Therefore, the maximum duration of emergency life support is, by and large, an intelligent approximation.

**Chlorate Candles:**

Though rarely used in submersibles, another source of emergency oxygen is from chlorate candles composed of sodium chlorate (82-88%), barium peroxide (3%) and a binding material. When the candles are ignited, a chemical reaction ensues which releases high purity oxygen at a rate depending mainly on the candle's cross section. The oxygen produced is passed through a filter which removes salt spray and cools the oxygen. The average property of chlorate candles (3) are:

Oxygen produced	
per pound of candle	0.32-0.38 lb
Specific gravity	
of candle	2.4
Heat generated	100 Btu ft <sup>3</sup>
Storage life	10-15 years
Gas purity	better than 99%

**Loss of Electrical Power**

The total loss of electrical power in all submersibles means loss of horizontal maneuverability, external lighting and avoidance sonars. In a number of submersibles it

may also mean loss of normal life support, and, perhaps, underwater communications. Loss of maneuverability, lighting and avoidance sonar or other working instruments is not in itself critical if the vehicle is clear of overhead obstructions. In this situation the operator informs the surface support ship of his plight and surfaces by non-electrical deballasting or by using emergency power to drop ballast. Where fail-safe deballasting systems are incorporated, such as the bathyscaph's automatic dumping of iron shot with loss of power, surfacing is automatic. The situation can become critical, however, if power failure occurs when the submersible is under ice, in an overhanging canyon or under a cable or bottom-mounted hardware. In such situations submersibles, as far as can be determined, have no other option but to ascend vertically. The threat to safety is obvious, and the only recourse may be to wait for surface assistance. In the fail-safe jettison situation there is no recourse but to surface, since, without power, the vehicle cannot stop ascending by using its vertical thruster. As discussed earlier in this section, the safety of the operation must take into account such contingencies prior to its initiation. Historically, submersibles rarely operated under conditions where a vertical ascent would be dangerous. Hence, loss of lateral maneuverability, lighting and other instruments generally resulted only in an aborted mission and delay in the diving schedule.

Loss of power, while not critical to most life support systems, may nevertheless have an adverse effect. The supply of oxygen would not be affected by a power loss, since it is released into the cabin by virtue of its being under compression. Removal of carbon dioxide, however, is dependent upon an electrically-powered blower which circulates cabin air through a scrubber. If the scrubber fails, carbon dioxide builds up. The only known exception to this is the **BEN FRANKLIN** wherein cabin air is circulated through thin panels of lithium hydroxide by natural convection currents.

Upon loss of electrical power there are several options open to the occupants (Table 14.3). One of these, automatic weight drop, has been discussed. Loss of lighting within

the cabin is counteracted with flashlights. The remaining two options are discussed below.

#### **Emergency Batteries:**

Some 25 percent of all submersibles carry an emergency source of power within the pressure hull. The source of this power may be from nickel-cadmium, silver-zinc, or non-gassing lead-acid batteries. In the event of a power failure the emergency batteries are used to jettison equipment or weights and to operate the underwater telephone, surface radio or surface flashing light, depending on the submersible.

#### **Non-Electrical Ascent:**

A number of vehicles have the capability to drop weights or blow water ballast independently of electrical power. In the water ballast blow the system is operated simply by introducing high pressure air, which is controlled by a manual valve within the pressure hull, into the external ballast tanks and, consequently, force the water out through the open orifice on the bottom of the tanks. As the vehicle surfaces, the air expands and continues to vent through the bottom orifice, thus maintaining pressure inside the tank equal to ambient and preventing the re-entry of water. In the weight drop situation a solid shaft through the pressure hull is manually rotated to actuate a cam-like release. Both systems are common in the shallow (less than 1,000-ft) submersibles.

## **EMERGENCY SYSTEMS (SURFACED)**

In spite of the various tracking systems available, not all submersibles use them, and it is common to spend some time searching for a vehicle after it has surfaced. In a flat, calm sea visual sighting is relatively easy, but swell or waves only a few feet high can make the low silhouetted submersible a difficult target to spot. Most difficult to locate are those vehicles painted white and surfaced in a white-capped sea where they blend unobtrusively into the background. A further complication is added when the search is conducted at night, although it is *sometimes* easier to locate the vehicle by its lights

at night than in the daytime. Location by radar from the support ship is seldom feasible because the small target offered by the submersible is lost in the sea return. More than any other hazard, separation or lost contact between submersible and support craft is the most likely to occur. A small submersible adrift on the open ocean offers little in the way of comfort or sustained survival to its occupants. To avoid this situation a number of devices are carried on and within the submersible.

If contact has been lost, an immediate concern is the life support endurance of the vehicle. Most submersibles have a sail surrounding their hatch which permits it to be opened in moderate sea without taking water aboard. Some vehicles are constructed such that the hatch is integral with the pressure hull and extends a few feet above the surface to allow opening. A small number incorporate neither of these characteristics and must rely on inflatable trunks which surround the hatch or on other means. Such designs are discussed below and the equipment and procedures employed to assist in emergency surface situations are listed in Table 14.4.

### **Separation from Support Craft**

The following devices are carried aboard submersibles to establish surface contact and bring together the vehicle and its support craft.

#### **Radio:**

The type and characteristics of radios aboard submersibles vary widely. Two-way citizen band radio transceivers are common where the submersible has sufficient freeboard to permit its use. Range of communications with the surface ship is limited to *line-of-sight* (5 to 10 miles). Hand-held radios are sometimes used, but to use these the hatch must be opened to extend the antennae, which is not always acceptable in a low freeboard submersible.

Radios serve two major post-dive functions: 1) By virtue of radio communications, they verify that the vehicle has surfaced; and 2) they establish that the surface support craft has or has not visually located the surfaced submersible. If the latter is the

case, action can be taken on the part of the submersible operator to assist location. A third function served by surface communication applies to those vehicles (*e.g.*, *DS-4000*, *SP-500*, *SP-3000*) which have no routine means of viewing when surfaced but do have radio antennae with thru-hull penetrations. In this case communications are used to apprise the operator of his situation regarding retrieval which is accomplished by the support craft and divers. In the pre-dive stage, radio communications also serve to inform the support craft of the vehicle's readiness to dive.

A radio signal may also be used as an aid to location of the submersible if its frequency is compatible with existing ship systems, and if the support ship is equipped with a radio direction finder.

#### **Underwater Telephone:**

As a backup to radios, underwater telephones may serve as a means of surface communications. In this mode the telephone's transducer obviously must be below the sea surface. Several submersibles have a second telephone transducer mounted on the bottom of the vehicle which serves as an alternate communications system. The majority, however, mount the transducer atop the vehicle for communicating with the surface when submerged. On the surface this transducer is out of the water and ineffective.

#### **Flashing Light:**

To facilitate nighttime location a flashing xenon light is atop many vehicles which can be activated from within the vehicle with the hatch closed. Where such lights are not included, the operator may have the option, if protection from flooding is afforded, of opening the hatch and using a battle lantern or flashlight to serve the same purpose. The submersible's underwater lights may be used as an additional means of location by the support craft, but the fact that the lights are underwater limits their use as long range viewing aids. Coast Guard requirements stipulate running lights; these may also serve in emergencies as well as during routine operations.

#### **Radio Signal:**

Only a few submersibles include a separate, self-powered, radio emergency beacon. *DEEP QUEST* is, as far as can be determined, the only submersible fitted with a self-powered omnidirectional emergency beacon which transmits a 121.5 MHz signal to assist homing in by Coast Guard aircraft. The rest rely on the support ship's radio direction finder to obtain a bearing on the vehicle.

#### **Distress Rockets and Flares:**

Should surface location not be possible through any of the above means, there are at least seven submersibles which carry distress rockets and flares to assist in visual location. Distress rockets (Fig. 14.11) are employed to signal the general location of the vehicle and the fact that the submersible is *in extremis*. Flares, smoke pots and dyes serve similar purposes, but also present a signal that may be visually traced to its source.

For safety reasons there is a reluctance on the part of some vehicle owners to carry pyrotechnic devices within the limited confines of a submersible's hull, possibly accounting for their absence in the majority of vehicles.



Fig 14 11 Distress rockets (left) and hermetically sealed parachute flares (right) may be fired from the launcher (center) carried aboard *DEEPSTAR 2000*.

### Anchors:

Very few submersibles carry anchors. Admittedly, their use from a surfaced submersible in the deep sea is impractical, if not physically impossible. However, a great deal of submersible work is performed not far from shore where separation from the support craft may place it in a position of drifting into shoal water before assistance can arrive. A number of the devices discussed above are shown in Figure 14.12 aboard *BEN FRANKLIN* prior to its 30-day drift.

### Life Rafts:

The French *SP-3000* carries a 1-man life raft for each of its three crew members and Westinghouse Corporation's *DS-2000* carries a 3-man life raft (Fig. 14.13); both are inflatable either manually or automatically.

### Breathing Gasses Expired

Several situations can occur whereby a surfaced submersible may find it necessary to flush out its cabin air or obtain additional breathing gasses: 1) Where the vehicle has lost all contact with surface support and is adrift sufficiently long to exhaust its life support system; 2) where sea state does not permit retrieval and the vehicle must be towed a long distance; and 3) where the normal cabin air has been contaminated. An obvious solution entails merely opening the hatch and flushing out the cabin. In the vast majority of submersibles this solution is possible, but it is limited by sea state. Protective fairings or sails around the hatch of many submersibles extend 3 or 4 feet above the waterline and afford protection from swamp-

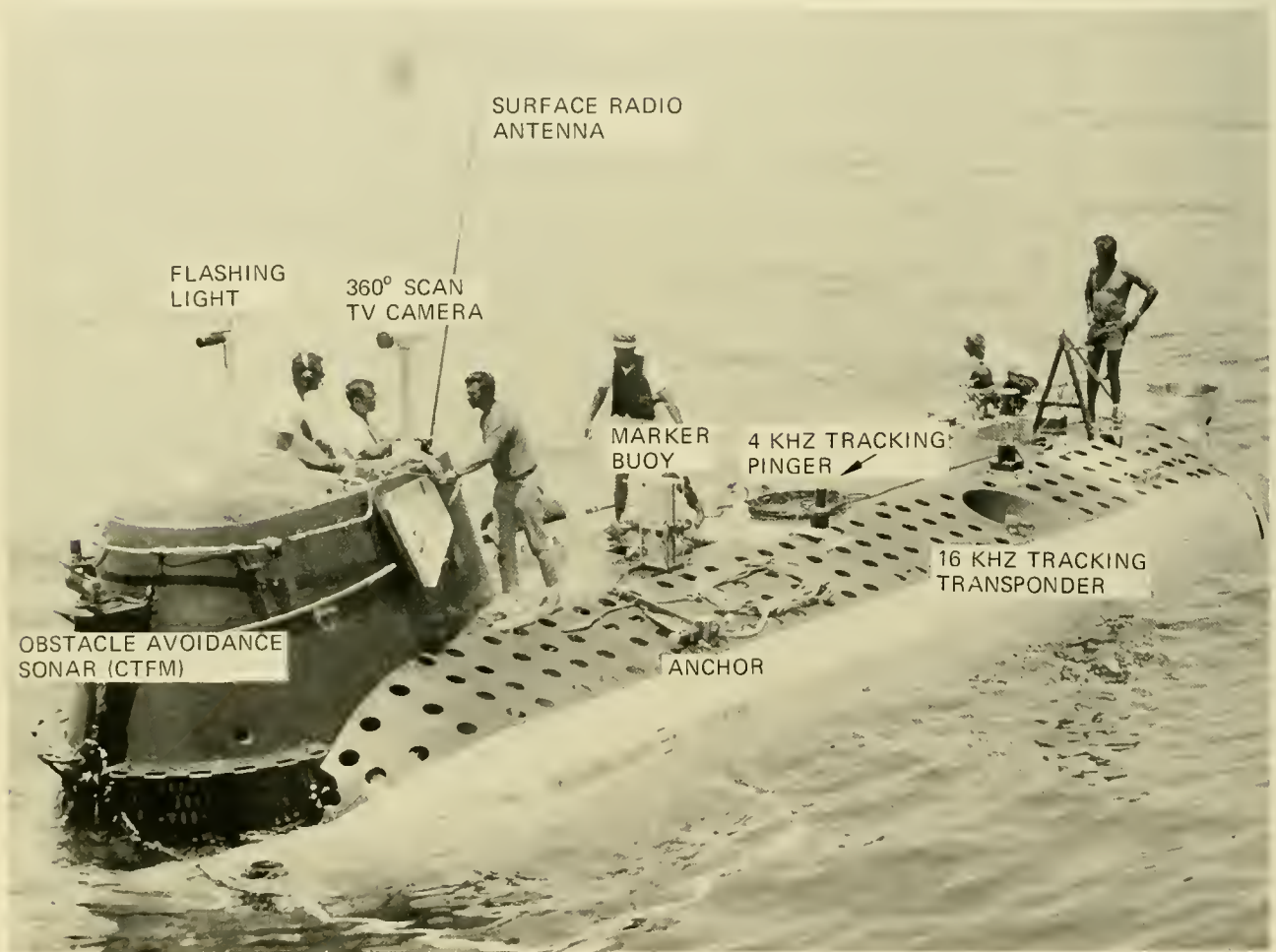

Fig 14 12 Various emergency preventive and corrective devices aboard *BEN FRANKLIN* (Grumman Aerospace Corp.)



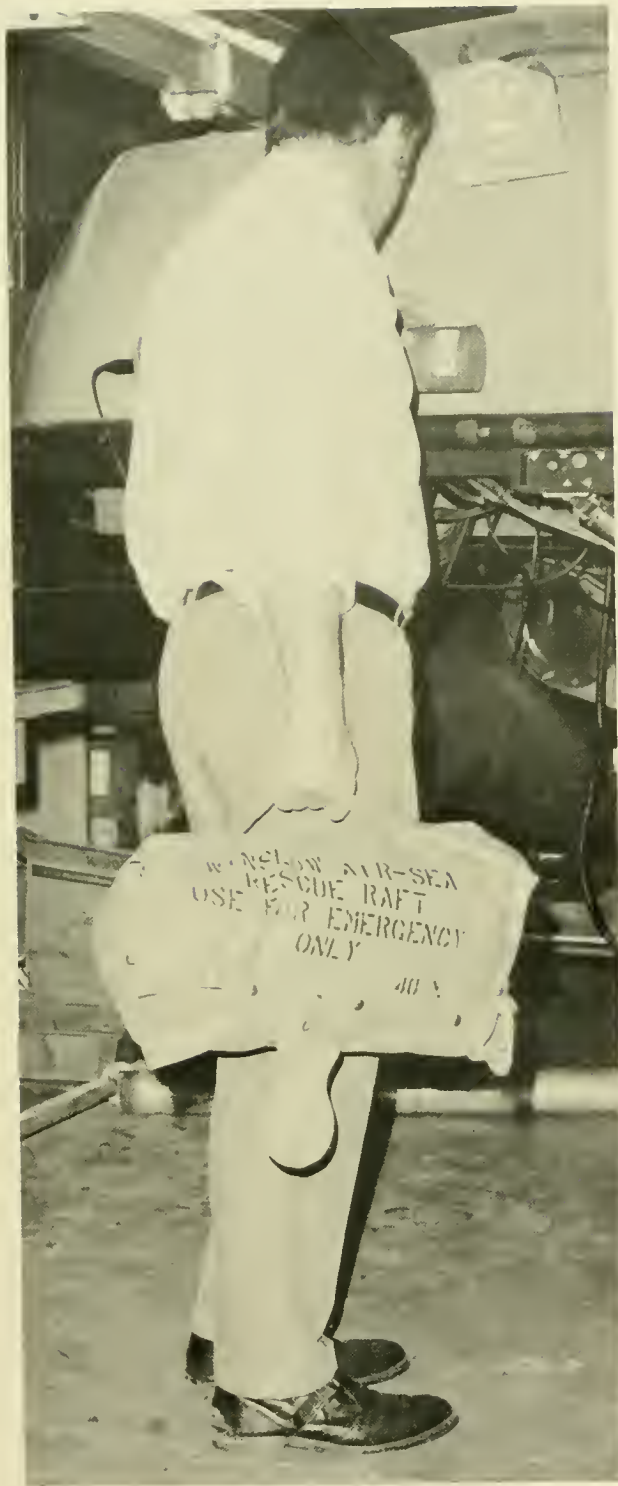

Fig. 14.13 DEEPSTAR 2000's 3-man "Winslow" life raft.

ing in sea state 6 and possibly higher. A substantial number of the shallow-diving vehicles have a conning tower which is an integral part of the pressure hull and extends 1 or 2 feet above the waterline where it is capped by a cover (Fig. 14.14). With these vehicles, opening the hatch in any but a very calm sea risks swamping. To avoid this, several submersibles incorporate special features to permit cabin air replenishment or egress from the surfaced vehicle.

#### **Inflatable Hatch Trunk:**

In *DS-4000*, *SP-350*, *SP-500* and *SP-3000* the hatch is below or just at the waterline when surfaced; if it were opened the pressure hull would flood. To avoid this the designers have incorporated an inflatable trunk or conning tower around the hatch which, when inflated, affords a measure of protection from the sea. In *DS-4000* (Fig. 14.15) an inflatable, 39-inch-high conning tower is installed around the periphery of the hatch. An externally-mounted air cylinder is used to inflate the rubberized nylon tower which is operated by turning a mechanical shaft within the pressure sphere. In normal vehicle operations, the tower is stored in a fiberglass trough. The storage housing is topped by a fiberglass cover integrated into the basic fairing and the cover pops free from its spring-loaded catches as inflation forces the tower upward.

#### **Inflatable Modules:**

The U.S. Navy's *MAKAKAI* has about 1.5 feet of freeboard at the hatch when surfaced. Hence, operator entry and exit are normally made with the vehicle on the support boat. In the event of a need for emergency exit, a system is incorporated to provide both freeboard and surfaced stability. This system consists of four inflatable rubber cylinders which are normally rolled and stowed in containers attached to the vehicle's frame. The cylinders are inflated from a 70-cubic-foot scuba bottle by actuating a solenoid valve. When inflated (Fig. 14.16), they provide an additional displacement of 55 cubic feet, thereby raising the hatch about 4 feet out of the water. The system also stabilizes the boat if one or both battery pods are released. Of the acrylic plastic-hulled sub-

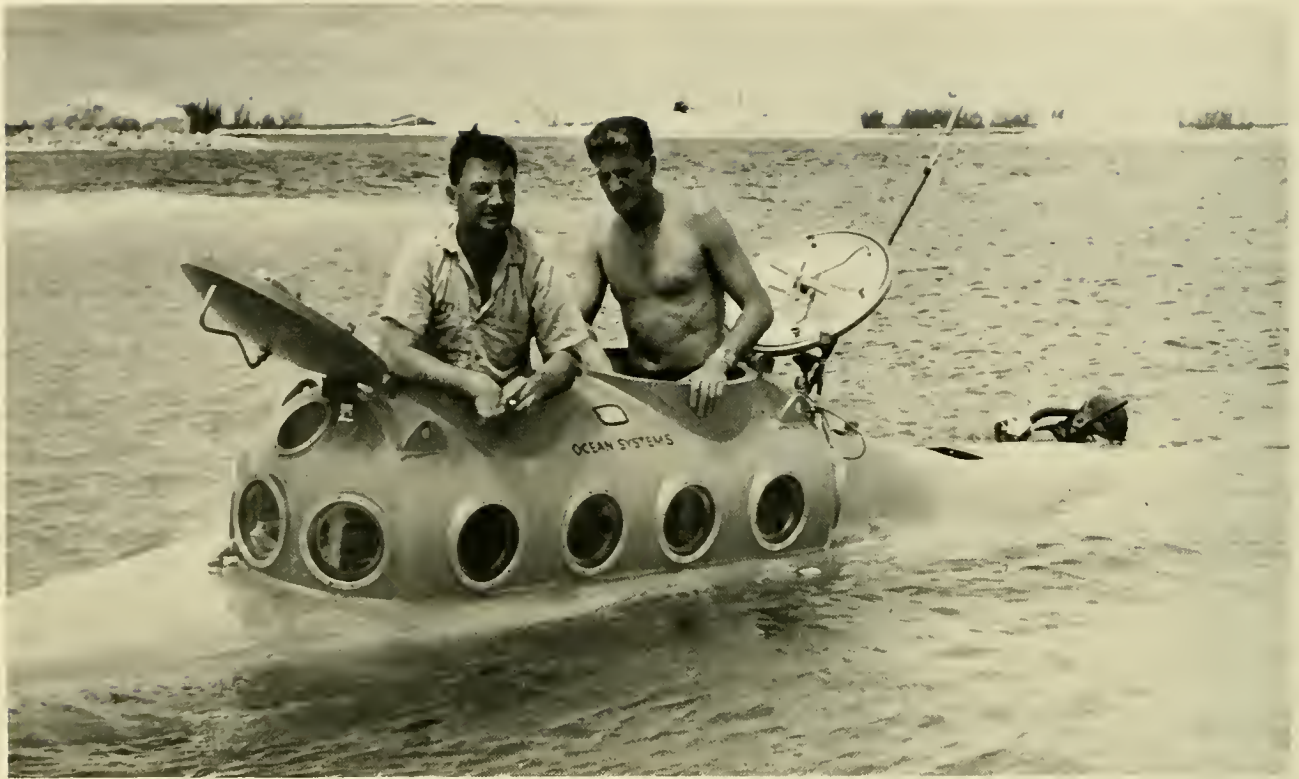

Fig 14.14 Protection from swamping is afforded by *TECHDIVER's* (PC-3B) extended pressure hull (NAVOCEANO)



Fig. 14.15 Inflated conning tower on *DEEPSTAR 4000*. (Westinghouse Corp.)

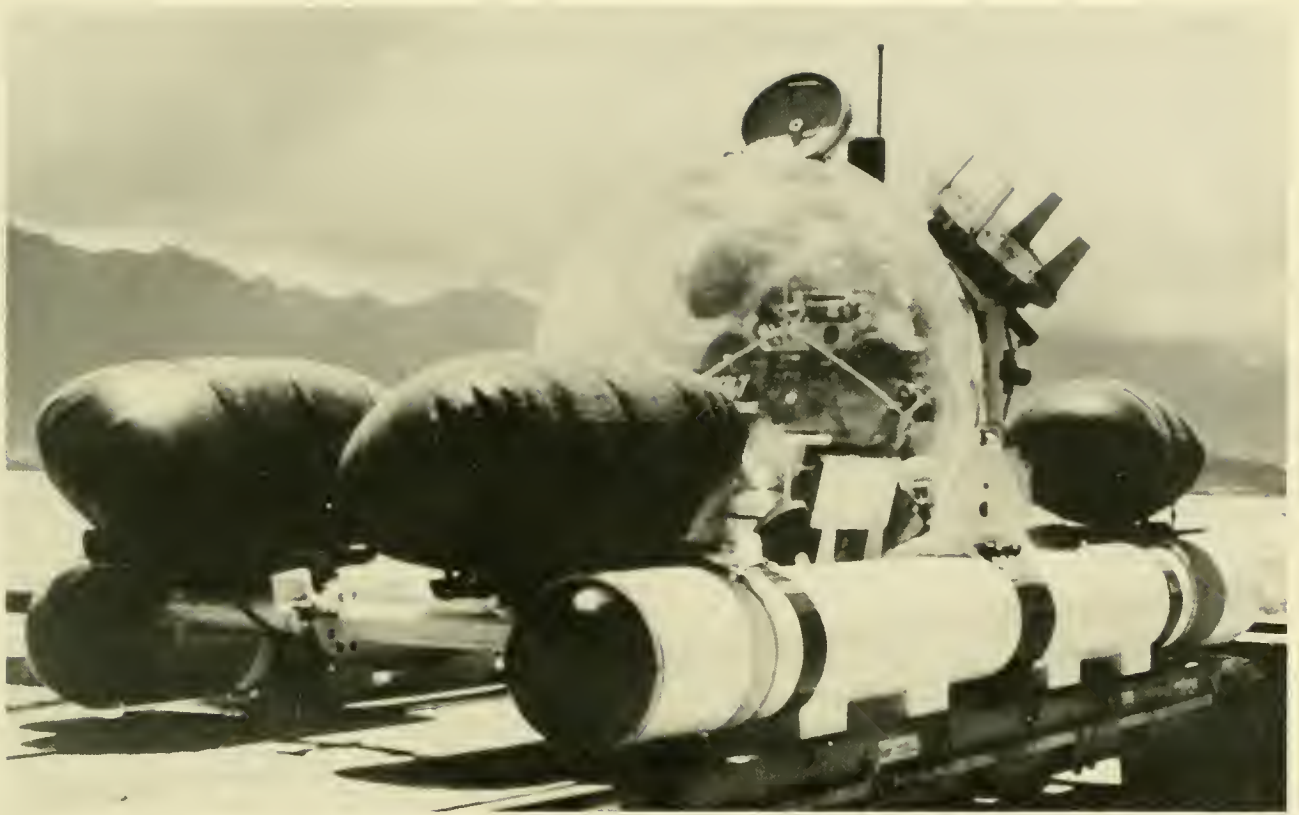

Fig. 14 16 Inflatable modules increase MAKAKAI's freeboard to about 4 feet for safe exit when surfaced. (NUC)

mersibles (*NEMO*, *MAKAKAI*, *JOHNSON SEA LINK*), only *MAKAKAI* provides a means of minimizing the potential for swamping. Unless flat calm conditions prevail, the occupants may safely open the hatch only when the submersible is aboard its support craft.

#### **Snorkel:**

Several of the shallow-diving vehicles and the early *FNRS-2* and *3* bathyscaphs incorporate a simple snorkel device which allows fresh air to enter the hull by merely opening a valve.

## **DEVICES TO ASSIST UNDERWATER RESCUE**

In the event that a submersible cannot surface and egress is impossible, there are instruments or devices available to the occupants to assist their rescuers (Table 14.5). From the rescuers' point of view the ques-

tions calling for immediate answer are: Where are they? How deep? What is the nature of the casualty? and What is the remaining life support? At this point, not only are the design and capabilities of the vehicle critical, but the ocean environment surrounding it is another salient factor.

A critical instrument in all rescue operations is the underwater telephone. If there is no means of communication between rescuer and rescuees, recovery of the submersible within its life support endurance would be fraught with uncertainty and difficulty.

In addition to the need for communications is the ability to locate the submersible. There are several underwater three-dimensional navigational systems commercially available through which a submersible may determine its own position or a surface craft may locate the submersible relative to itself with extreme accuracy (see Chap. 10). But such systems are quite expensive and beyond the operating budget of most private and many government owners.

## TABLE 14.5 DEVICES TO ASSIST UNDERWATER RESCUE

---

Marker Buoy  
Underwater Telephone  
Pingers/Transponder  
External Lights  
External Gas/Air/Electrical Connections  
Salvage/Lift Padeye  
Environmental Sensors  
Obstacle Avoidance Sonar

---

Of equal importance is the life support endurance—in the 1-man submersible *K-250* it is 6 hours; in the 6-man *BEN FRANKLIN* it is 252 man-days. Obviously the time available to locate, mobilize and employ rescue devices is virtually nil in the former and optimum in the latter. A histogram of total life support endurance (normal and emergency) is presented in Table 14.6. This information was obtained mainly from manufacturers' brochures and technical articles describing the vehicle. Total life support is given in man-hours and the normal maximum number of occupants is noted in parentheses. Dividing the number of occupants into total man-hours makes one fact quite clear: In an emergency, there is precious little time to respond and act. Of the total 79 submersibles on which life support data are available, the following are the percentages of vehicles wherein life support will expire between the given hour intervals:

6—24 hours:	36%
24—48 hours:	44%
48—72 hours:	15%
72 hours:	5%

The later into a mission an emergency occurs the less time there is, of course, to assess the situation, attempt self-cures and/or to call in outside assistance. Just how critical the situation can become is obvious if you subtract the time necessary to mobilize,

transport and deploy rescue teams and devices. This subject will be dealt with in a later section of this chapter. It is sufficient to note that 80 percent of past and present vehicles have a life support duration of no more than 48 hours, a precariously short time in which to effect underwater rescue.

Depth, water temperature, visibility, currents, surface conditions and a variety of other environmental factors govern both the type of rescue attempts or devices that can be used and the methods in which they may be deployed. These factors, of course, cannot be controlled by the submersible, but information as to their presence and scope can be provided by the vehicle's occupants to aid the rescuer in his choice and deployment of rescue devices.

In order for any external devices to be effective, the submersible must be accompanied by a surface support craft of some description either to effect rescue or to call in assistance. There are no hard and fast rules applied to submersible diving, but few submersibles, if any, dive without a surface support craft in attendance.

### Telephones

Table 14.1 shows that over 75 percent of all submersibles carry an underwater telephone. This does not mean that all have the same communications capacity; some are

TABLE 14.6 TOTAL LIFE SUPPORT DURATION (MAN-HOURS)

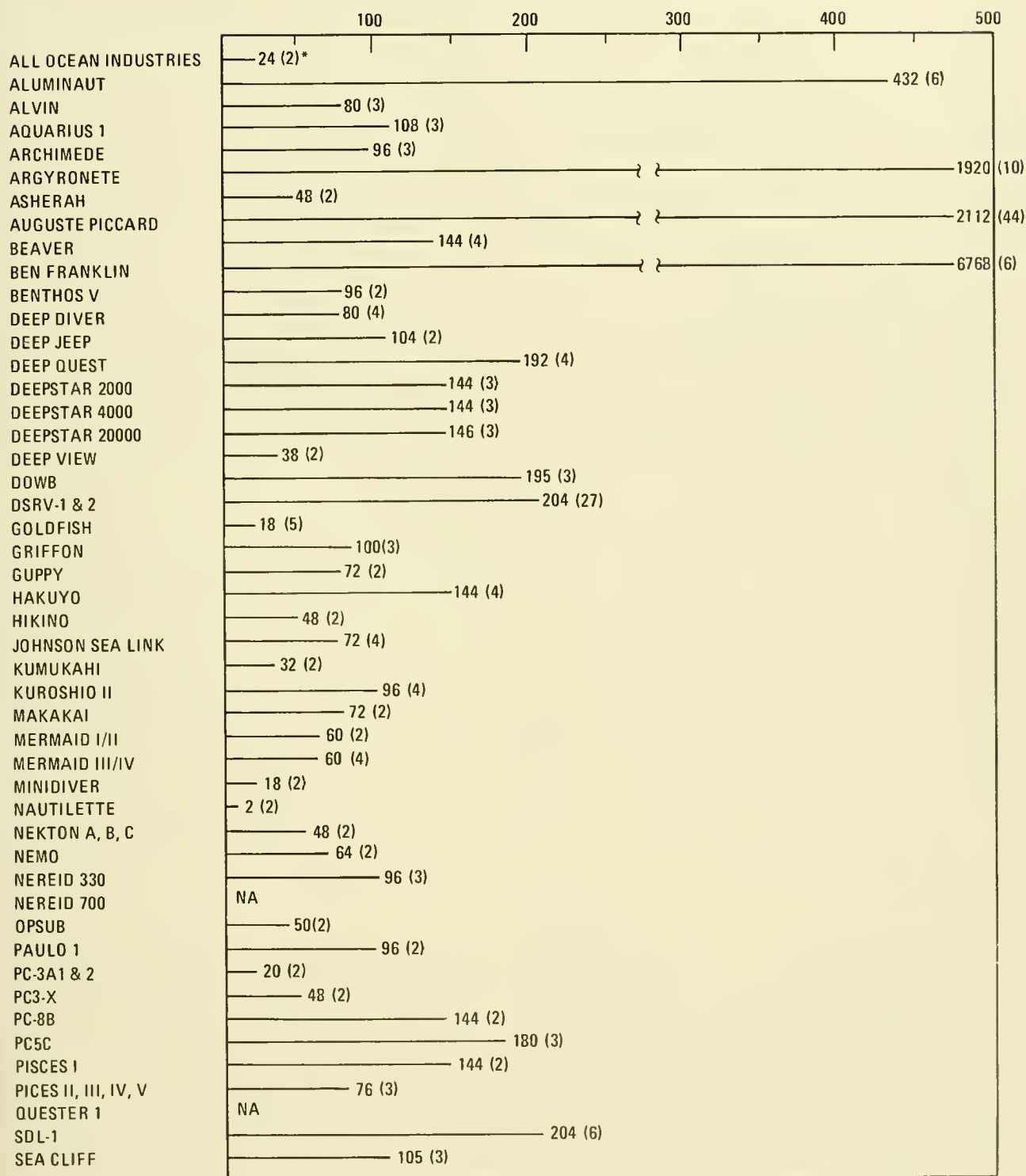

(\*) Normal crew complement including passengers.

TABLE 14.6 TOTAL LIFE SUPPORT DURATION (MAN-HOURS) (Cont.)

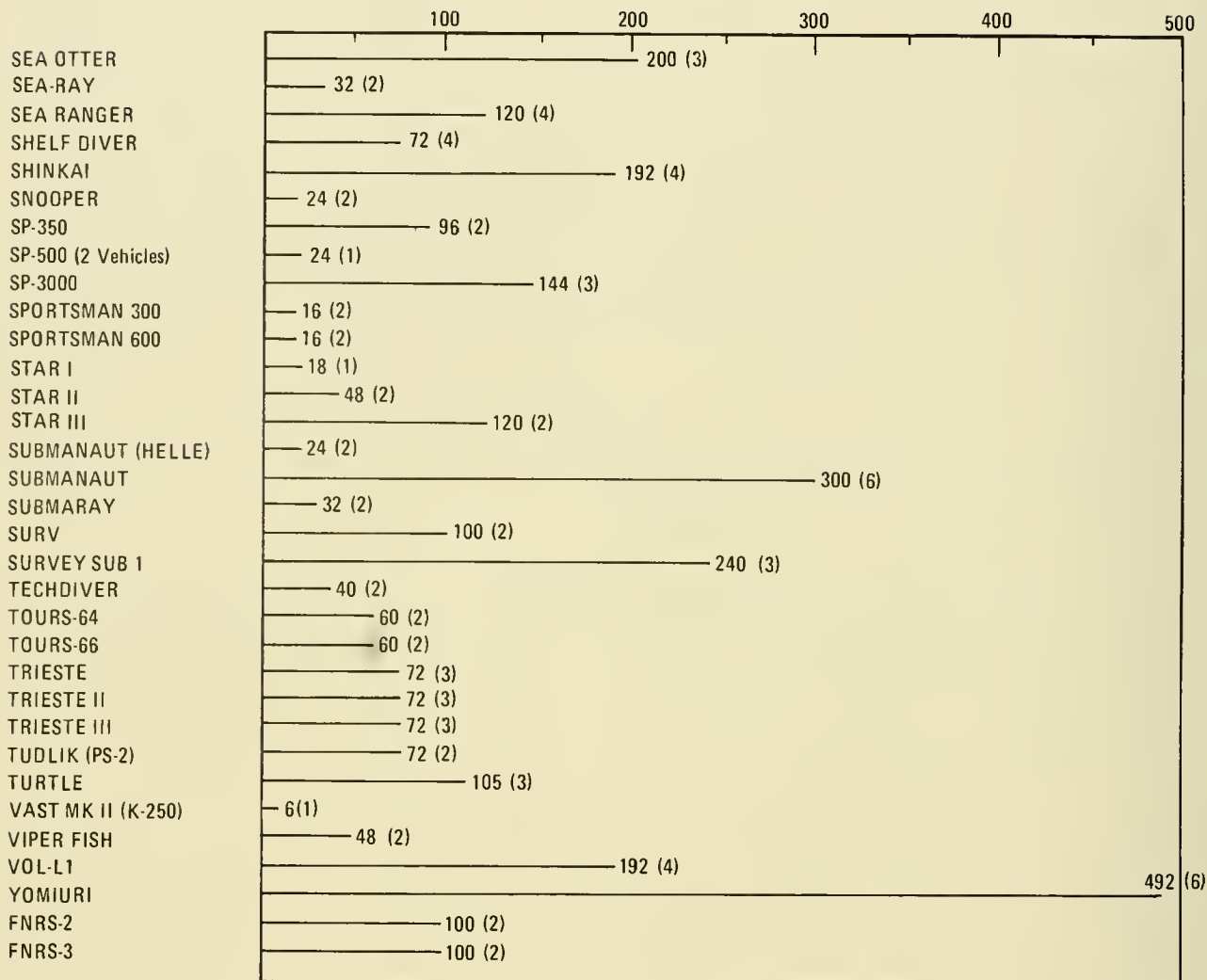

( ) \*Normal crew complement including passengers.

very short ranged and carrier frequencies are not consistent.

Fortuitously, most use a carrier frequency of about 8 kHz, and are compatible with U.S. Navy underwater telephones (UQC) which operate on 8.0875 kHz. This means that they may be assisted by a variety of Naval as well as civilian vessels. The underwater telephones reported in use aboard submersibles are shown in Table 14.7. It shows that a few operate on other than 8 kHz, thus precluding communications not only with Naval units but most other submersibles as well. From the sources available, the only known excep-

tions to the 8-kHz carrier frequency are *SEA OTTER*, *SUBMANAUT* (Helles), *PS-2*, *KUMUKAHI* (24-28 kHz) and *SP-350* (42 kHz).

The ranges presented in Table 14.7 are advertised ranges and, in some cases, ranges supplied by the vehicle's owner. These are slant ranges, and allowance must be made for the vehicle's depth and bearing relative to the support craft when computing horizontal range. Depending on water conditions these ranges may be more or less than specified. The bathyscaph *TRIESTE* obtained excellent reception and transmission at a depth of 35,800 feet with its 8-kHz underwater tele-

phone built at NEL especially for **TRIESTE**. In certain areas reception is poor even though the range is well within that advertised—*e.g.*, when the vehicle might be in a deep canyon, and echoes produce weak or garbled messages. Similar communicating problems may be encountered in shallow slant-range modes between surface vessels and submerged vehicles. Thermal discontinuities occur where the transmission is entirely masked or where the same signal arrives at closely-spaced, but different time intervals (as a result of multipath transmission). Optimum surface-to-subsurface communications occur when the surface ship is directly or nearly directly over the submersible and acoustical signal paths are normal to near-surface temperature (density) discontinuities. Similarly, good communication is usually obtained between two or more sub-

mersibles at depths below the thermocline. There are no standard practices for frequency of communications between submersible and support craft. Some operators insist on immediate surfacing if communications are lost, while others allow operations to continue for some specified time and then, if communications are still out, require surfacing. Still others merely wait to see what went wrong after the vehicle's operator decides to surface (4).

Tethered submersibles, such as **GUPPY** and **KUROSHIO II**, rely on a hard line communication system built into the power-supplying umbilical between surface ship and submersible. From the information available, it is unclear whether or not a wireless means of communication is available in the event that the cable parts. Some shallow diving vehicles, *e.g.*, the **NAUTILETTE** se-

TABLE 14.7 MANNED SUBMERSIBLE UNDERWATER TELEPHONES

Manufacturer	Model No.	Carrier Frequency (kHz)	Max Range (yd)
Aquasonics Engineering Corp. San Diego, Calif.		8	4,000
		42	3,000
Hydro Products San Diego, Calif.	DV-811	8.0875	4,000
Helle Engineering San Diego, Calif.	3600 (UTO 1)	25.3-28.5	4,000
	(He-14A)		
	3114	42	2,000
	415II	8-11	10,000
STRAZA Industries El Cajon, Calif.	200-W	8.0875	15,000
	ATM 502A	8.0875	15,000
	ATM 503	8.3-10.7	7,500
	ATM 504	8.0875	15,000
	ATM 504A	8.0875	20,000
SUBCOM SYSTEMS, LTD No. Vancouver, B.C.	100S-20A	8.075 or 25	6,000
			3,000
	110S-20	8.0875	6,000
	127S-20	25	3,000
Westinghouse Underseas Div. Annapolis, Md.	400A	8.0875	25,000
	415A	8.087	10,000

ries, use a hard line telephone attached to a radio-equipped surface buoy, thereby obtaining both a tracking and communications capability on a single system.

A most fundamental means of communication is found in *BEN FRANKLIN*'s SAS. This consists of a small cylindrical chamber in the top of the pressure hull into which hollow glass balls are placed and "locked-out" to the surface. The diameter of the hatch is 150 mm. Messages were sent in the glass spheres to the support ship during the Gulf Stream Drift mission. While this system is obviously limited and irreversible, it does constitute a means of one-way communications when all else fails.

### Marker Buoys

Undoubtedly, the surest method of locating a submersible is by the attachment of a buoy. Several submersibles have the capability of releasing a buoy which is held to the vehicle by a thin line. Depending on the submersible, the buoy and line may serve several purposes. At the least, it provides a visual target which potential rescuers may follow to the vehicle; at most, a hook and stronger salvage line can be slid down the marker line to automatically attach to a lift padeye on the vehicle. *SEA OTTER* incorporates this latter feature which is shown in Figure 14.17.

### Acoustics

The function of acoustic pingers and transponders was discussed earlier to the extent that they are used to maintain a given range and bearing between support craft and submersible. In an emergency situation these devices may be used by a rescuer to locate and home in on the submersible, using either another submersible or an unmanned rescue device. Several factors control usefulness of pingers. At the very least the rescuer must be able to receive the frequency of the transmitting device. Further, the majority of pingers and transponders are self-powered and, therefore, limited in duration. The variety and capabilities of pingers and transponders are so numerous that to list all could be confusing. For example, some 40 companies in the U.S. manufacture pingers, and 46

manufacture transponders. To further expand the list, a variety of pingers and transponders is available from each manufacturer. A current list of pingers from Helle Engineering shows 23 models with ranges of 0.5 to 5 miles, duration of 2 days to 5 years, frequencies of 8 to 50 kHz and depth ranges of 600 to 10,000 feet. Many competitors offer an equally wide variety.

It should be mentioned that other sources of acoustic transmissions are available on submersibles, in addition to pingers and transponders. The majority of underwater telephones listed in Table 14.7 are capable of continuous wave (CW), as well as voice, transmission. In the CW mode a telephone can also serve as a homing beacon.

Likewise, upward-looking echo sounders, side scan sonars, obstacle avoidance sonars and other acoustic devices found on some submersibles offer some degree of homing capability. At the lower end of the spectrum is sound produced by the occupants tapping on the hull which may serve as a crude source of communications and a very limited homing beacon.

In order for any system to be an effective communications or homing device for rescuers or for assistance from sources other than its support craft, the support craft must carry a ship-to-shore radio and some form of surface positioning system. When a submersible is working out of sight of land the support craft may attain its own position via a sextant or an electronic aid to navigation which may be accurate to within several miles to a few hundred yards. In any event, because of the considerable difficulty in returning to the same position and reestablishing acoustic contact with the submersible, it would be unwise for the support craft to leave the scene to seek assistance (or for any other reason). On the other hand, one might expect the support craft to immediately plant a buoy to aid in maintaining and/or regaining the submersible's position in the event of a pinger or other critical electronic component failure. Planting a marker buoy may be easily done if the submersible is in shallow (200-ft) water, but in the case of the deeper vehicles, the thousand or more feet of line required is not generally a part of the support craft's on-board inventory.





Fig. 14.17 *SEA OTTER's* marker buoy (Grmsby Float) is released by rotating a handle in the hatch cover which pulls out a restraining pin. As the float ascends it reels out the  $\frac{1}{4}$ -inch line which is spooled around and attached to a 25-ton-capacity cable shackled to the hull. The ice tong-like device is slid down the line which is fair-led through a hole in the block holding the tongs open. Reaching the cable, the block is knocked out and the tongs close on the cable. A lift line attached to the tongs is then employed to retrieve the vehicle.

If the support craft carries no accurate positioning system from which it can ascertain its position and relay it to potential rescuers, then more time is lost by the rescuers in searching for the support craft. And, as we have seen, time is of the essence—for every minute spent cuts into the all-too-short life support.

### External Lights

Depending on water clarity, a submersible's lights (Fig. 14.18) may offer a visual means of homing in on the vehicle once the rescuers have obtained its relative bearing and are within viewing range. In essence, lights are a secondary device to assist rescue, in that other devices (pingers, marker



Fig 14 18 ALUMINAUT's lights provide an excellent means of visually-locating the vehicle from several hundred feet distance. (Reynolds Submarine Services)

## External Air/Gas/Electrical Connections

In order to replenish deballasting air, breathing gasses or electrical power, external attachments are incorporated into a small number of vehicles which allow replenishment while submerged. One of the simpler methods is found on the *All Ocean Industries vehicle* which incorporates a standard scuba tank manifold through its hull (Fig. 14.19). The ease with which resupplying can be made is dependent upon depth. A diver is most effective, but he is depth-limited. A submersible is less effective owing to its decreased maneuverability and manipulative dexterity. Equal to the submersible's capability are the unmanned devices which also have less maneuvering and manipulative ability than human beings, but both manned and unmanned systems are capable of operating to depths encompassing 98 percent of the ocean floor (20,000 ft).

buoys, etc.) provide the primary means of locating the submersible at long range.

### Lift Padeyes

Most submersibles have a padeye or ring to which a line or cable is attached for launch or retrieval. This can serve as a point of attachment for emergency lifting, assuming it to be clear of interfering obstructions. Such padeyes, however, are not of standard size and location, and finding and attaching a suitable hook may take time. A few of the larger (greater than 15 tons) submersibles are launched by a cradle supporting them from the keel. In this case there may be no padeye, and this could cause salvage to become unduly complex and time-consuming while a suitable lifting arrangement is designed and fabricated.



Fig 14 19 A scuba bottle valve attached to a thru-hull penetration provides air from a scuba tank to blow main ballast in the All Ocean Industries vehicles. The rack in the foreground holds the scuba bottle.

## Environmental Sensors

Five environmental factors exert a heavy influence on rescue efforts: Depth, temperature, currents, visibility and sea state. Depth gages are standard on all submersibles, and this value may be relayed to the surface. Should there be no telephone on the vehicle, the support craft may measure the depth. The remaining factors may differ widely from surface values, and must be measured or estimated *in situ*. Temperature has its greatest influence on divers by both directly and immediately affecting the quality and duration of their performance. The majority of submersibles do not carry an external thermometer, and, hence, have no direct way of measuring seawater temperature. Indirectly ambient temperature may be measured by measuring the internal pressure hull temperature which produces an approximate value. The hull material has a major influence on such indirect measurements owing to the different thermal conductivity of metals and plastics.

Currents directly affect the maneuvering ability of both manned (including divers) and unmanned devices. Current meters are rarely carried on submersibles; thus, the occupants may only have the ability to measure water speed and direction by the visual observation of suspended particles in the water column. By observing particle movement relative to the submersible's heading (determined by a compass) a fairly accurate estimate of direction may be obtained. Speed estimates are far more difficult because there are no reference points; hence, the estimate reduces to "fast" or "slow."

Visibility ranges are more difficult to measure and no known submersible routinely carries the instruments required for such measurements. There is almost always a few feet of visibility in the open ocean. In coastal or estuarine areas this is not always the case, and, at times, changing tides, sediment run-off from land and seasonal plankton blooms may reduce visibility to nil.

There is little one can do about high sea states except to wait for better conditions and then act immediately when they arrive. One can recommend that diving only be conducted when several days of good weather are predicted, but such recommendations are

impractical when diving in, for example, the North Sea where "good" weather is a relative term and, at certain times of the year, is measured in hours rather than days.

## Avoidance Sonars

Submersibles with trainable obstacle avoidance sonars may be able to actively acquire rescuers and direct them to the site by means of the underwater telephone. If the stricken vehicle is immobilized its ability to scan and acquire a target is reduced to its sonar's training ability, and to be effective to its maximum range there must be no obstacles to transmission. Such devices can offer significant assistance to rescuers, as was demonstrated when an entangled **DEEP QUEST** used its CTFM sonar to vector the submersible **NEKTON** to within visible range (5).

Such are the capabilities the various submersibles have to avoid, respond to and assist in potential or actual emergency situations. It is emphasized that no one submersible carries all these devices or possesses all these capabilities. At this point in time, the emergency equipping of a vehicle is up to the owner.

In September 1972 a Submersible Safety Seminar, sponsored by a variety of government and private organizations, was held at Ft. Pierce, Florida. The results of this seminar have not been formally published, but the proposals for improved submersible search and rescue capabilities offer an insight into the thoughts of recognized deep submergence authorities. Though all participants did not unanimously concur with all proposed measures, the following capabilities were listed as desired:

- Submersible:**
1. External attachments for providing breathing gas to occupants whenever practical.
  2. A homing device, *e.g.*, pinger, between 10- to 40-kHz frequency and 72-hour duration.
  3. Appropriate coloring and optical lights for both surfaced and submerged detection.
  4. An appropriate and accessible emergency lift attachment.

**Support Craft:** 1. A standard lift hook equivalent or superior to those used by the U.S. Navy (25-ton forged titanium snap hook).

The results of this seminar contain a number of practical recommendations for increasing the safety of submersible operations and are included in the Marine Technology Society's *Safety and Operational Guidelines for Undersea Vehicles, Volume II*, published in 1974.

## REFERENCES

1. Todd, M. R. 1972 *Progress in submarine escape in the Royal Navy*. Conf. Papers, Oceanology International 72 Conference, 19-24 Mar. 1972, Brighton, England, p. 506-507.
2. Mavor, J. W., Froehlich, H. E., Marquet, W. M. and Rainnie, W. O., Jr., 1966 *ALVIN, 6,000-ft. Submergence Research Vehicle*. Proc. Ann. Meeting of the Soc. Naval Architects and Marine Engineers, New York, 10-11 Nov. 1966, n. 3, 32 pp.
3. Penzias, W. P. and Goodman, M. W. 1973 *Man Beneath The Sea*. Wiley Interscience, John Wiley & Sons, New York, 831 pp.
4. Link, M. 1973 *Window in the Sea*. Smithsonian Inst., Wash., D.C.
5. Wenzel, J. G. 1969 *Emerging capabilities in underwater work systems*. Trans. of the Symposium "Working in the Sea", 20-22 Oct. 1969, Mar. Tech. Soc., Wash., D.C., p. 209-230.



# 15

## EMERGENCY INCIDENTS AND THE POTENTIAL FOR RESCUE

Since the beginning of modern deep submergence, a variety of near fatal and fatal situations have occurred which tested many submersibles' ability to extricate themselves from or endure an emergency. Unfortunately, there has been no central point whereby such emergencies could be filed and later analyzed to provide guidance toward safer vehicles and operating procedures. On the other hand, there was, and still is, no clear definition of an emergency. Where loss of communications may be an emergency to one, it may be considered simply an irritation to another. A leaking penetrator on *BEN FRANKLIN* was not considered serious enough to surface and abort its mission; in such cases it's the degree, not the occurrence

of a leak, that constitutes an emergency. Distinguishing an emergency from a routine malfunction is still arbitrary.

To gain an appreciation for the variety and nature of submersible emergencies and accidents and the ability of past and present systems to respond, documented and undocumented incidents will be briefly discussed in this section. The majority of these incidents are taken from a report by Mr. J. A. Pritzlaff (1), Chairman of the Marine Technology Societies Undersea Vehicle Safety Standards Subcommittee, who reviewed some 20 different accidents and incidents with the goal of deriving information which could be used in subsequent submersible operations. When Pritzlaff is not the source, it is so noted, and

the appropriate reference given. Where no reference is provided, it is from the author's personal experience.

One or two submersibles appear more frequently than others in the following incidents; this is not because they are less safe, but reflects the fact that they either dived more often or their incidents were recorded and published. **DEEPSTAR 4000**, for example, appears quite frequently. This can be attributed to its frequency of diving between 1966 and 1969 (approximately 500 working dives) and the fact that Mr. Pritzlaff is an employee of **DS-4000's** owners (Westinghouse Corp.) and has access to its diving history.

## INCIDENTS

As far as is known, the only instrument used to avoid exceeding operational depth which has performed satisfactorily is the depth gage. Automatic deballasting or restraining (surface buoys) devices seem, instead, to have worked as the following incidents demonstrate.

### Buoys

Submersible: **PC-3B (TECHDIVER)** Date:  
5 June 1965

**Incident:** Trailing a 0.25-inch-diameter nylon line and surface buoy, **PC-3B** found forward movement impossible at a depth of 400 feet along a vertical escarpment in the Tongue of the Ocean, Bahamas. After backing down, it was found that the line was hung on an outcrop. The line's breaking strength was believed beyond the ability of the submersible to break by deballasting; hence, it was removed and not used on subsequent dives in this operation.

Submersible: **SP-350 (DIVING SAUCER)**  
Date: 1959 Reference (2)

**Incident:** Trailing a 330-foot nylon line attached to a surface buoy, **SP-350** experienced difficulty in steering. Turning the vehicle around, the operator found that the line was snagged on a coral head at the 100-foot depth and, by maneuvering, freed the line.

Submersible: **PC5C** Date: NA Reference (1)

**Incident:** On shallow missions Perry operated vehicles (**PC5C**, **SHELF DIVER** and others) periodically towed surface buoys for tracking purposes. These buoys have occasionally become entangled in surface structures or the tracking ship. In one case, the ship caught the buoy line and actually dragged the submersible off course. Because the buoy and buoy line were firmly attached to the submersible and there was no method available for the submersible to release the line if it became entangled, a line release/cutter assembly was added to the submersibles to jettison the line.

Submersible: **DEEP JEEP** Date: ca. 1966  
Reference (3)

**Incident:** While submerged, **DEEP JEEP's** "fail-safe" electromagnetically secured ballast plates accidentally dropped and, without the operator's knowledge, the submersible began to ascend with five or six ships overhead. The operator was able to bring the vehicle to a halt 30 feet below the surface where he remained until located by his support craft and cleared to surface.

### Underwater Obstacles

Submersible: **ASHERAH** Date: 1964 Reference (1)

**Incident:** **ASHERAH** was operating in a depth region where wave action was a factor. There were no guards on the viewports and no structures in front of the pressure hull. The submersible struck an underwater object and the viewport cracked, but did not flood. External guards were later installed in front of the viewports (Fig. 15.1).

### Loss of Normal Surfacing

Submersible: **SP-350** Date: 1959 Reference (2)

**Incident:** At 360 feet deep **SP-350's** nickel-cadmium batteries short-circuited. The ascent weight was dropped and the vehicle began to ascend until gas generated in



Fig 15.1 Though its bow equipment rack prohibits head-on hull collision, ASHERAH's unprotected downward-looking viewports were susceptible to contact with sharp pinnacles.  
(Gen Dyn./Elec. Boat)

the brass battery boxes exploded and the vehicle descended. A 450-pound emergency weight was dropped and *SP-350* surfaced.

Submersible: *DEEPSTAR 4000* Date: 25  
October 1966 Reference (1)

**Incident:** The vehicle was to take core samples; the dive was made with *DS-4000* in a heavy (75-lb) trim condition, *i.e.*, after the descent weight was dropped the vehicle was still negatively buoyant. Trim weights could be dropped to achieve neutral buoyancy if desired. With the vehicle on the bottom at

4,000 feet deep and maneuvering around to place the corer, about 100 pounds of silt were picked up in the fairing cavities. The hydraulic system failed due to mechanical seizure of a face seal and the mercury trim system could not transfer mercury forward to drive in the corer tubes. It was decided to abort the mission and surface. The following events occurred: a) The 186-pound ascent weight could not be released hydraulically and the manual backup release was initiated. The weight hung up in its housing and did not drop. b) The small trim weights (about 150-lb capacity) could not be dropped due to the lack of hydraulic power. c) The mercury of the trim system (200 lb) was released using the nitrogen blow system but the vehicle was still heavy. d) In an unrelated situation, the variable ballast bottles had flooded (80 lb) due to faulty silver brazed piping joints. Weight resources available included the vehicle brow with its scientific instrument suite (70 lb) and the forward battery (450 lb). Since the exact weight status of the vehicle was not known at the time, the forward battery was dropped (450 lb) and the vehicle ascended. The up trim angle of the vehicle also shook out the ascent weight. A rapid, safe ascent was made.

Submersible: **PISCES III** Date: 1971 Reference (4)

**Incident:** During a dive at approximately 600 feet deep, **PISCES III** experienced difficulty in attaining level trim. A check of the emergency warning systems revealed that the aft machinery sphere was flooded. Main ballast tanks were blown but the vehicle merely came to a near-vertical, bow-up position and remained stern-first in the bottom. The Canadian Defense Ministry's **SDL-1** was undergoing sea trials at the same time and at the same location, and carried down a lift line which it attached to **PISCES III's** port motor guard. Some 8 hours later the vehicle was winched to the surface. A postmortem revealed that drain plugs in the machinery's sphere were left open during the dive and allowed seawater to enter and flood the sphere.

## Entanglement

Submersible: **DEEP QUEST** Date: October 1969 Reference (1)

**Incident:** While conducting a recovery test in 430 feet of water, **DEEP QUEST** became entangled with a  $\frac{3}{8}$ -inch polypropylene line. The line was caught in the port propeller of the vehicle and anchored the submersible to the test object. The submersible **NEKTON** was transported to the scene and, attaching a diver's knife to its manipulator, cut **DEEP QUEST** free. At any time during its entanglement **DEEP QUEST** had the capability of dropping its batteries which would have brought both the vehicle and its "anchor" to the surface.

Submersible: **JOHNSON SEA LINK** Date: 17 June 1973 Reference (5)

**Incident:** Attempting to retrieve a fish trap at 360 feet deep, the submersible became entangled in the rigging of a scuttled destroyer. Divers tried to extricate the vehicle, but strong currents resisted their efforts. The submersible **PC-8** tried to assist but its obstacle avoidance sonar failed and it was ordered to discontinue efforts. Approximately 32½ hours later a device holding a television and a grapnel was lowered to the submersible and coned into its final approaches by the submersible's operator using the underwater telephone. The device was hooked onto the **JOHNSON SEA LINK** and she was jerked free. Two occupants in the aluminum lock-out cylinder perished. The two occupants of the acrylic plastic forward sphere survived. Cause of death was ascribed to carbon dioxide poisoning when the carbon dioxide scrubbing compound (Baralyme) lost its effectiveness due to low temperature (about 40°F) in the cylinder.

Submersible: **PISCES III** Date: 29 August 1973 Reference (6)



**Incident:** The submersible was on the surface for retrieval when the towing line from its support ship fouled on the hatch of the aft machinery sphere and tore the hatch cover off. The sphere flooded and **PISCES III (P.III)** sank stern-first to the bottom at 1,575 feet. **PISCES V (P.V)** was sent with a 4-inch-diameter polypropylene rope that would be fitted into **P.III's** sphere opening. **P.V** was eventually forced to attach the line to the starboard propeller guard. Six and one-half hours were required to locate **P.III** due to an error in **P.III's** depth gage, abnormal processing of **P.V's** gyrocompass and ship traffic interfering with tracking and underwater communications. **P.V** finally homed in on **P.III** with its sonar. The line attached by **P.V** was used as a marker buoy on which a pinger was slid down to **P.III** to assist homing, **PISCES II** and the unmanned CURV each subsequently placed a line on **P.III** and the submersible was brought to the surface.

Submersible: **TS-1** Date: 14 October 1974  
Reference (21)

**Incident:** During a pipeline inspection at 275 feet deep in the North Sea, a rope fouled in the stern propeller of **TS-1** and held it fast to the bottom. Six hours after fouling, divers were able to cut the restraining line free and the craft was able to surface under its own power.

### Loss of Electrical Power

Submersible: **STAR III** Date: August 1966  
Reference (1)

**Incident:** During operations off Bermuda, the battery box of **STAR III** failed due to insufficient pressure compensation, and a total loss of electrical power ensued. Subsequently, the main ballast tank was blown and the vehicle surfaced.

Submersible: **GUPPY** Date: NA Reference (1)

**Incident:** Operating in the Bahamas, **GUPPY** experienced flooding in a propulsion

motor resulting in a massive electrical short circuit to the 440 VAC supply (cable power from the surface). The power connector at the motor had two seating surfaces that were to seal when the connector was properly attached. Investigation of the flooding showed a dimensional error of 0.012 inch such that the connector looked seated but in reality was not. Surfacing was accomplished by reeling in the power cable as is normally performed.

Submersible: **BEAVER** Date: June 1970  
Reference (1)

**Incident:** During operations off Santa Barbara, **BEAVER** experienced a propulsion system short circuit and lost power to the starboard propulsion motor at 1,545 feet. Port and starboard trim was affected and some arcing and smoking occurred inside the pressure hull. A short circuit in a junction box burned a hole in the starboard propulsion cable. The oil-compensating system for the junction box tried to account for the loss of oil in the box; this resulted in the loss of the compensating oil which affected the vehicle's trim. The smoke in the pressure hull was not sufficient to warrant use of the emergency breathing devices by the four occupants.

Submersible: **SP-350** Date: 1959 Reference (2)

**Incident:** Operating at 50 feet, the vehicle's nickel-cadmium batteries short circuited. Owing to the poor thermal conducting properties of the oil-filled, fiberglass boxes the compensating oil reached the boiling point. The submersible surfaced by dropping its ascent weight and was placed aboard the support ship to allow the occupants to exit. The carbon dioxide fire extinguishers were unequal to the fire and it was necessary to put the vehicle back into the water to extinguish the fire.

Submersible: **TRIESTE II** Date: July 1964  
Reference (8)

**Incident:** Searching for the remains of the submarine **THRESHER** at 8,200 feet, a severe short circuit occurred in the bathyscaph's main propulsion motors. The overload relays in the battery circuit failed to open and they arced over to each other causing the batteries to discharge to zero and melt the battery cables. Emergency batteries in the sphere allowed control of shot dropping and continuation of the life support system. The author points out that if the fire had been elsewhere than underwater, the arcing, which occurred only 4 feet from the gasoline reservoir, could have ignited the 46,000 gallons of high octane gasoline in the buoyancy tanks.

Submersible: **UZUSHIO** Date: June 1974  
Reference (20)

**Incident:** Diving in 33 feet of water the tethered diving bell **UZUSHIO** experienced an electrical short circuit in the interior vinyl wiring insulation. An alarm on the support ship **WAKASHIO** sounded and the bell was brought to the surface within moments. Less than 2 hours after the alarm sounded the two occupants were dead, the cause being either toxic fumes or rapid consumption of oxygen by the fire. It has been reported that the vehicle's designer subsequently committed suicide.

### Separation From Support Craft

Submersible: **DEEPSTAR 4000** Date:  
1968 Reference (1)

**Incident:** The vehicle was diving at night in the vicinity of the Gulf Stream. The subsurface current profile did not follow the surface current profile. This resulted in separation of **DS-4000** from its support ship and loss of communications. Using established "loss of communications" procedures, the vehicle surfaced. An electrical storm affected the small "CB" radio and surface communications could not be established. Six hours after surfacing the pilot fired a small flare that was seen by the support ship. Because of this incident, the submersible's "CB" radio was replaced with a higher powered FM system and an FM direction finding capability

was added to the support ship. The submersible flare system was upgraded to a 20-mm size with a parachute flare capability.

Submersible: **DEEPSTAR 2000** Date: 5,  
6 July 1972 Reference (9)

**Incident:** The submersible was diving in Wilmington Canyon, 125 nm southeast of Cape May, New Jersey. Tracking was conducted with a range and bearing device from a small (16-ft) boat with three people aboard; the small boat was visually kept in sight by the support ship. Weather predictions were obtained from a New Jersey commercial radio station which predicted occasional showers and 10- to 15-knot winds. At 1405 hours (LCT) **DS-2000** routinely surfaced out of visual range of both the small boat and the support craft. Radio contact was established with the submersible and its flashing xenon light was on to assist recovery. By 1515 hours squalls and low clouds came into the area which reduced visibility to several hundred yards. The support craft and small boat proceeded in a direction they believed would take them to the submersible. Though separated by only 200 yards, the small boat lost visual contact with the support craft but maintained radio contact. The weather was deteriorating rapidly and winds increased to 35-50 knots with seas of 12 to 15 feet in height. One hour and 25 minutes after **DS-2000** surfaced, the support craft, not able to locate either the submersible or the small boat, radioed the Coast Guard for help. At 1900 hours a Coast Guard aircraft sighted **DS-2000's** light and vectored the support craft to it. The weather was now so inclement that retrieval was unacceptable and the support craft maintained visual contact with the submersible until 1350 hours the following day when it retrieved the submersible under extremely trying conditions. The small boat, on the preceding evening, reported that it had found a buoy and would tie up to it. At this point its radio went dead. The description of the buoy as received from the small boat matched nothing on the charts of the area. In spite of a 10-foot-high radar reflector in the small boat, the sea return was sufficient to mask out any radar

contacts. Early the following morning (6 July) the Coast Guard informed the support craft that the small boat and its occupants had been picked up by a Spanish fishing boat which had planted the buoy to which they had tied their craft.

Submersible: **ALVIN** Date: 1965 Reference (16)

**Incident:** Diving off Bermuda, the telephone communications failed and the submersible was separated from the mother ship for 10 hours. The surface ship began searching without knowing in which direction the submersible lay. In addition, radio communication failed, requiring assistance from Coast Guard aircraft to re-unite the vessels.

### **Environmental Hazards (Natural)**

Submersible: **ALUMINAUT** Date: NA Reference (1)

**Incident:** While on sea trials in Long Island Sound, **ALUMINAUT** lost depth control and made a rapid excursion toward the bottom. The operational area crossed the offshore mouth of the Connecticut River. The submersible, trimmed for salt water, became heavy as it entered the fresh water river flow. The change in buoyancy was calculated at 3,500 pounds. Immediate action was to blow ballast tanks, drop shot and power up with the vertical propeller. Subsequent water sampling showed fresh water down to 120 feet. The operating area was shifted to avoid the effects of the river.

Submersible: **DEEPSTAR 4000** Date: 21 November 1967 Reference (11)

**Incident:** Diving off the island of Cozumel, Mexico, **DS-4000** was proceeding upslope from 4,000 feet deep and observed a weak current setting SSW, with a 0- to 0.1-knot drift between depths of 3,350 and 1,400 feet. Ascending through 1,400 feet another current setting NNE was encountered. The speed of this current increased rapidly as the submersible proceeded upslope and reached

almost 2 knots at a depth of 900 feet. This strong current was accompanied by reduced visibility and made it impossible to control the vehicle. The dive was aborted and the vehicle was forced to surface. A similar condition occurred on the following dive off Misteriosa Bank in the Caribbean; in this case the dive was aborted at 2,550 feet when the submersible was swept into a spin.

Submersible: **FNRS-3** Date: 1955 Reference (2)

**Incident:** During a dive into Toulon Canyon the bathyscaph bottomed on a mud shelf at 4,920 feet. While ascending from the shelf, the bathyscaph's guide chain apparently broke loose a block of mud causing a mud slide or turbidity current. A sediment cloud was generated which reduced visibility to zero. In an effort to steer clear of the sediment cloud, **FNRS-3** proceeded across the canyon on a descending course and ran into the opposite wall at a depth of 5,250 feet. After more than an hour's wait, the sediment cloud, caused by impact with the opposite wall, had not cleared; the vehicle began ascent and at a height of 800 feet above the bottom visibility returned.

Submersible: **ALUMINAUT** Date: February 1966 Reference (12)

**Incident:** During a search for a lost hydrogen bomb off southern Spain, the submersible had occasion to make frequent contact with the soft, muddy bottom. Openings in the vehicle's keel, to facilitate flooding, acted as scoops through which sediment entered and accumulated. When this situation was finally noted, the submersible had picked up an estimated sediment weight of 4,000 pounds.

Submersible: **ALVIN** Date: 1967 Reference (13)

**Incident:** **ALVIN** was on a routine geology dive on the Blake Plateau, off Charleston, S.C., when shortly after landing on the

bottom at 1,800 feet, a swordfish weighing about 250 pounds made a deliberate attack on the submersible. The fish's bill penetrated the fiberglass skin between the releasable forebody and afterbody and became wedged there by the pressure sphere. The initial inclination was to continue the dive since no apparent damage had occurred. Shortly thereafter, the leak detector system, which monitors sensitive areas for salt water intrusion, showed a positive indication and the dive was aborted. A post-dive analysis revealed that the leak detector reading was unrelated to the attack. A swordfish attack was also experienced by **BEN FRANKLIN** during its 30-day drift in the Gulf Stream. In this case the swordfish did not lodge in the vehicle or cause any damage.

### **Environmental Hazards (Man-Made)**

Submersible: **DEEPSTAR 4000** Date: NA  
Reference (14)

**Incident:** The submersible was operating off the California coast under the auspices of the U.S. Naval Electronics Laboratory. Though **DEEPSTAR 4000** had requested Navy clearance to dive in the area, it had not received permission at the time of the dive. When the submersible bottomed, three 5-inch projectiles exploded about 200 yards astern of the support ship. The shore facility was asked by radio to contact fleet operations and request that the firing be halted. Contact was made, firing ceased, and **DEEPSTAR 4000** surfaced and was recovered. The support ship was escorted from the area both by the cruiser which had fired upon it and a submarine that had surfaced in the interim. Later it was found that the area was scheduled for fleet training and the support ship was mistaken for the target ship due in the area about the time of the incident.

Submersible: **SEA OTTER** Date: 1973  
Reference (15)

**Incident:** In the process of inspecting the trash gates of Bennett Dam, Williston

Lake, British Columbia, the submersible was drawn against the gates and held by an estimated 8-knot current. Initial estimates placed the current at 2 knots. To free itself, the operator requested that the generators be shut down which, in turn, would eliminate the current. As the current abated, a mass of water-soaked logs and other debris which was also held against the gates by virtue of the currents rained down on the vehicle. Several hours were required for the submersible to extricate itself.

Submersible: **STAR II** Date: 1967  
Reference (NA)

**Incident:** The vehicle was conducting an inspection of an offshore oil structure in the Gulf of Mexico at a depth between 100 and 150 feet. Sudden increase in current strength and change in direction caused the vehicle to collide with one of the supporting structures and to damage its controls beyond functional ability. Divers were dispatched to assist the submersible which could not make its way out of the structure without its controls. Before the divers arrived, the submersible drifted free of the structure and eventually surfaced by blowing ballast.

### **Launch/Retrieval Incidents**

Submersible: **ALVIN** Date: 16 October 1968  
Reference (1)

**Incident:** The elevator between the hulls of the catamaran **LULU** was lowering **ALVIN** into the water when the forward, port side cable parted. The additional load caused the starboard cable to part and **ALVIN** slid off the platform into the water. The pilot, standing in the sail, swam clear; water was entering the pressure hull, but the two occupants made a fortunate and miraculous escape. The hatch could not be completely closed during this emergency situation due to the presence of the vehicle's control cable extending from the control center in the sphere to the portable control box held by the pilot in the sail. The submersible sank to the bottom at 5,052 feet and was retrieved *in toto*, on 28 August 1969 (Fig. 15.2).

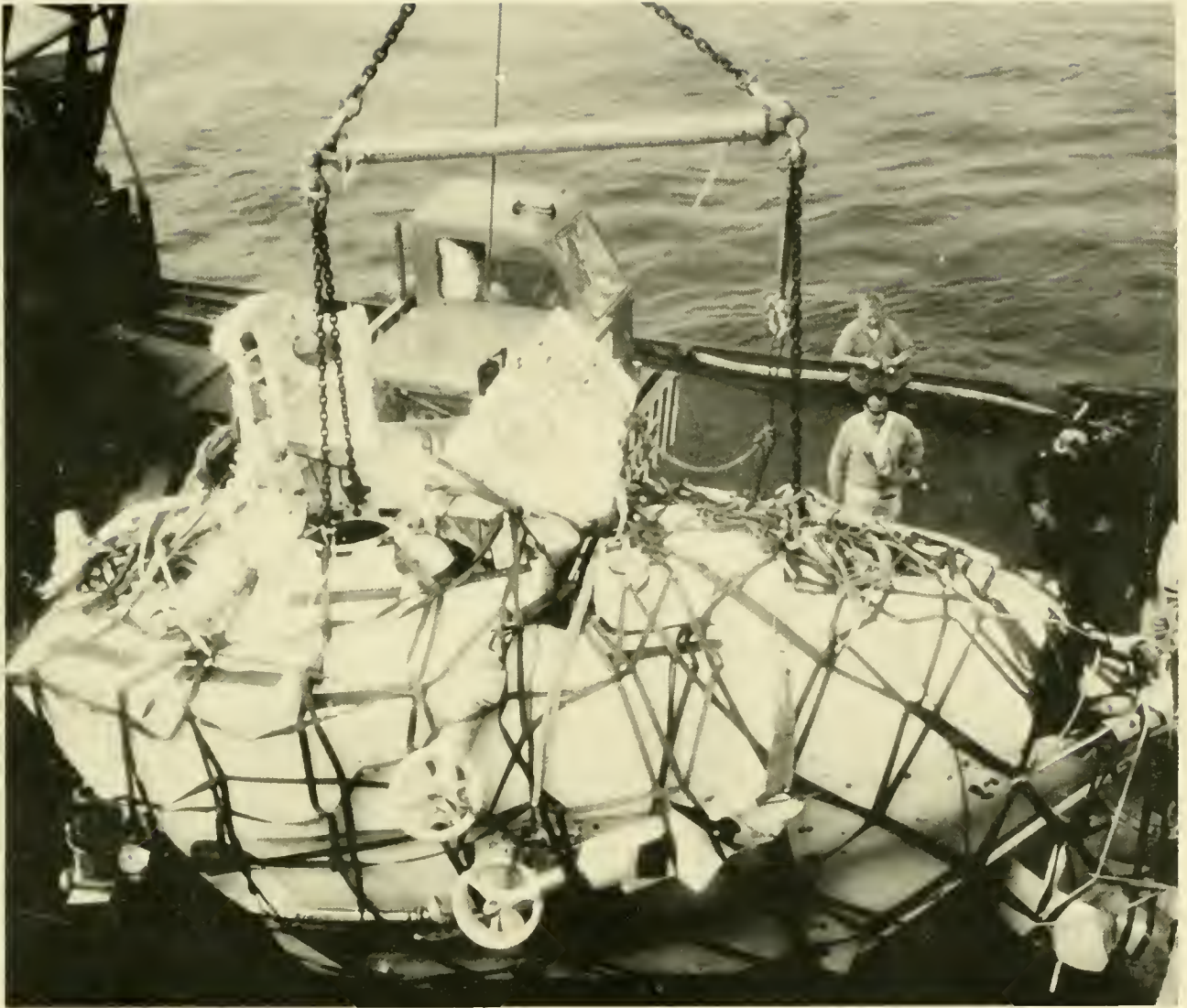

Fig. 15.2 ALVIN after 10½ months at 5,052-foot depth. (WHOI)

Submersible: **DEEPSTAR 4000** Date:  
May 1967 Reference (1)

**Incident:** **DEEPSTAR 4000** was performing a series of test dives at Panama City, Florida. During launch, the vehicle was hoisted off the deck of its support ship and swung over the side. Some 5 feet in the air, the quick-release launching hook unexpectedly opened and dropped the vehicle into the water. The events surrounding the unex-

pected release were examined. As far as could be determined, the release line was not fouled nor had it been accidentally pulled. Examination of the hook showed that under certain conditions a mechanical open/closed indicator could point to closed when, in fact, the hook was only partially latched. It was concluded that the visual check of the hook showed a "closed" hook and the OK to launch was given. The hook, in fact, was only partially closed. It held the vehicle load (18,000

lb) for the lift and 180-degree swing, but the stop-rotate motion of the crane was enough to open the hook and drop the vehicle. The crew was shaken up and some vehicle damage was sustained.

Submersible: **DEEPSTAR 2000** Date: NA  
Reference (1)

**Incident:** During a rough water launch, **DEEPSTAR 2000** unexpectedly dropped a battery which forms part of the vehicle's safety system and can be dropped using a manual cable release. The cable runs from a manual crank on the pressure hull through the exostructure to the battery box. Flexing of the exostructure during the launch was sufficient to trip the release mechanism and drop the battery. The exostructure was subsequently stiffened in those areas where interaction with the battery drop cable was significant.

Submersible: **BEAVER** Date: Summer  
1973 Reference (16)

**Incident:** Prior to demonstrating their ability to launch/retrieve the submersible **BEAVER**, a perspective contractor to the vehicle's owner, International Underwater Contractors, made modifications to the lift system which included fairleading a cable through a shackle welded to the deck of the ship. With **BEAVER** attached to the lift device, a strain was taken on the fairlead cable which proved too much for the shackle weld. The shackle broke loose and fatally struck an observer in the chest.

## Operational Incidents

Submersible: **BEN FRANKLIN** Date: April  
1970 Reference (1)

**Incident:** **BEN FRANKLIN** was moored astern of its anchored support ship when a sudden storm came up. The combined drag of the support ship and **BEN FRANKLIN** caused a failure in the anchor system and both vessels were forced onto a reef. The submersible, having minimal surface propul-

sion capability, was damaged in the keel and battery pod areas. The support ship was finally able to maneuver itself and **BEN FRANKLIN** clear of the reef.

Submersible: **BEAVER** Date: March 1969  
Reference (1)

**Incident:** **BEAVER** was being launched for operations from a marine railway on Catalina Island, California. The weather at this time was described as "rough" and when the vehicle reached the point of becoming buoyant the waves caused it to pound on the runway and inflict damage to the submersible.

Submersible: **NEKTON BETA** Date: 21  
September 1970 Reference (1)

**Incident:** **NEKTON BETA** and its sister submersible **NEKTON ALPHA** attached lift lines from a barge to a sunken cabin cruiser at 230-foot depth some 500 yards off Santa Catalina Island, California. The **ALPHA** submersible surfaced, but **BETA** elected to remain submerged during the lift. At about 50 feet off the bottom the lift lines parted and the cruiser fell through the water. In doing so it struck **BETA** and broke a section out of a conning tower viewport. **BETA** flooded and sank to the bottom where pilot R. A. Slater was able to exit the vehicle and ascend to the surface. The observer, L. A. Headlee, perished.

Submersible: **GUPPY** Date: NA Reference  
(1)

**Incident:** While operating in the Santa Barbara Channel, **GUPPY** had been recovered in a normal fashion. The sea was calm and the crew exited the vehicle. The hatch was open and the hoisting winch cable was still loosely attached. A sudden sea swell caused the support ship to roll unexpectedly and **GUPPY** slid along the deck until stopped by the winch cable. If the cable had not been attached, the vehicle would have probably gone over the side with its hatch open.

The foregoing incidents demonstrate the wide variety of related and unrelated events which may lead to fatal accidents. Analyzing some 20 different accidents/incidents, the majority of which are included in the foregoing list, Pritzlaff concluded that the need for good seamanship and maritime sense paralleled that of sound submersible design; in essence, he has euphemistically restated Simon Lake's observation that ". . . *no one makes a fool of himself* . . . ."

An equally interesting point also emerges from the incidents listed above: 15 out of the 22 different submersibles involved were either U.S. Navy certified or ABS classified; the remaining 7 had undergone only their builder's quality control program. So it would appear that a certified or classified vehicle is no more immune to accidents than those which are not. Of course, one can only speculate on how many more accidents there might have been if those 15 were not certified, but the majority of the incidents described were due either to the method of employing the vehicle or from environmental factors, not faulty design or construction. This is not to imply that some form of certification or classification is undesirable, it is meant to place the cause of accidents in perspective.

## RESCUE POTENTIAL

In the event that a submersible is trapped on the bottom, and egress is impossible, what devices are available which may be employed to rescue the occupants? In the final analysis there are three means available: divers, other submersibles and self-propelled, remotely-operated, unmanned devices. The selection of which device to use is dependent upon a host of variables, the prime one being the nature and depth of the disability. For this reason, it is difficult to imagine one device satisfying all of the possible emergency situations. Preliminary to a discussion of the capabilities of these three devices, should be a consideration of the rescue philosophy: Underwater transfer of personnel to a rescue capsule, or recovery of the submersible with the occupants inside.

### Underwater Transfer

In the United States there are presently

two devices designed and operated for the rescue of personnel from a stricken submarine: the **DEEP SUBMERGENCE RESCUE VEHICLE (DSRV)** and the **SUBMARINE RESCUE CHAMBER (SRC)**.

#### **DEEP SUBMERGENCE RESCUE VEHICLE-1 & 2:**

**DSRV-1** and **2** (Fig. 15.3) were designed to mate with a stricken submarine, take aboard 24 personnel at a time and return them to a surface support craft or a mother submarine. They are air, sea (surface and subsurface) and land transportable and capable of rescue from 5,000 feet. The distressed submarine must have a 6-foot-diameter flat plate (machined to specific tolerances) surrounding its hatch to which the **DSRV's** transfer skirt can mate, pump out entrapped water, and thereby effect a pressure differential which holds it to the submarine. At this stage the **DSRV's** and submarine's hatches are opened and personnel transferred. The procedure is reversed to unmate. No mechanical linkages are required, but the area surrounding the plate and hatch must be cleared of obstructions. A brief rescue scenario of the **DSRV** is presented in Figure 15.4.

#### **SUBMARINE RESCUE CHAMBER (SRC):**

The **SRC** (Fig. 15.5) is a rescue cylinder carried aboard all U.S. Navy **ASR's** (Auxiliary Submarine Rescue) and it is capable of rescuing submarine personnel from depths



Fig. 15.3 The **DSRV-1**, capable of rescuing 24 personnel from a military submarine at 3,000 feet. The black and white bell on the underside is configured to mate with the distressed submarine (U.S. Navy)

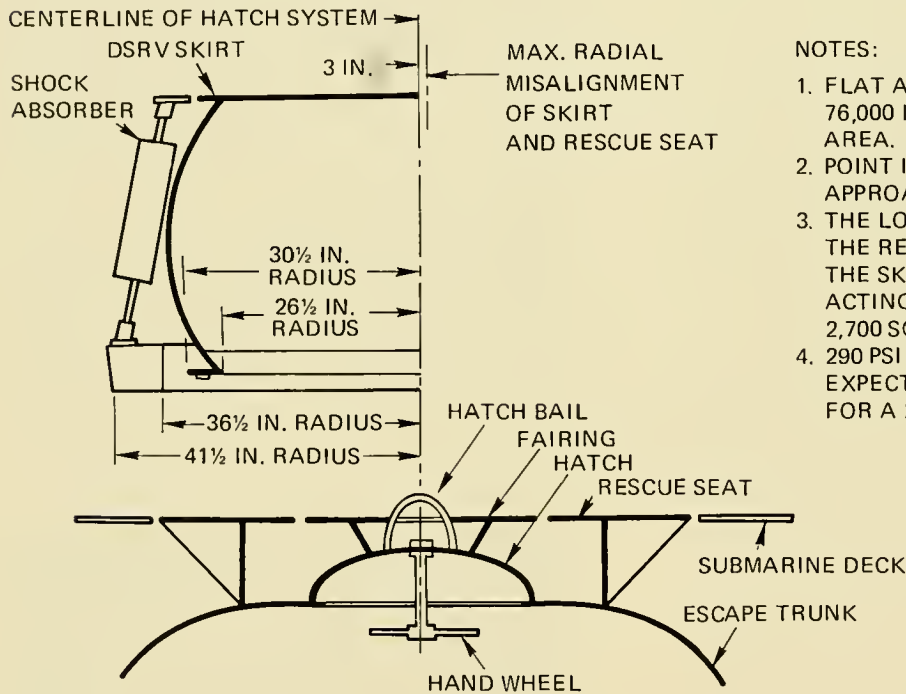
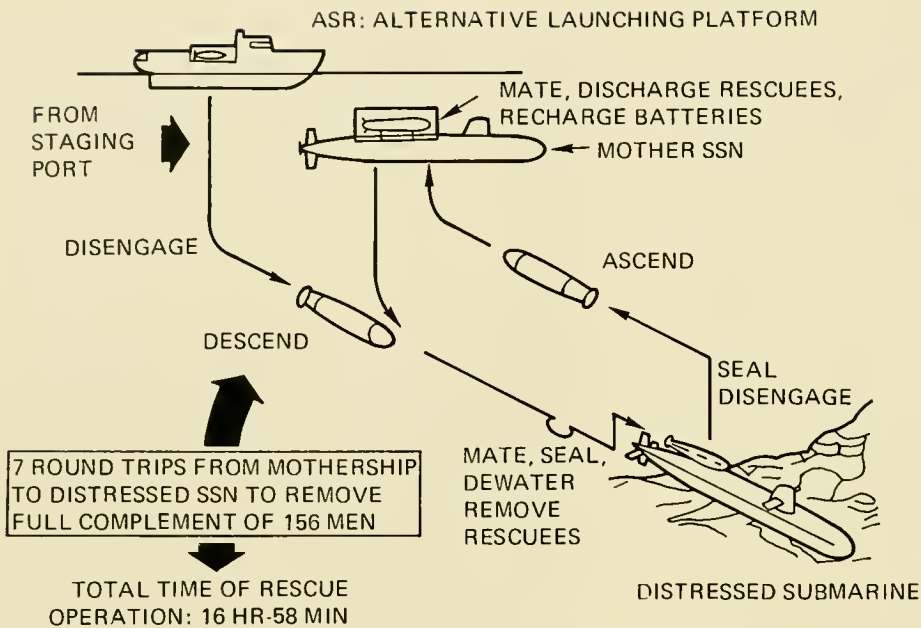

NOTES:

1. FLAT APPROACH MAX. LOAD IMPACT 76,000 LB TOTAL OVER THE CONTACT AREA.
2. POINT IMPACT LOAD AT ANGULAR APPROACH IS 30,000 PSI MAX.
3. THE LOAD THE SKIRT WILL EXERT ON THE RESCUE SEAT AFTER DEWATERING THE SKIRT IS HYDROSTATIC PRESSURE ACTING OVER THE SEALED AREA OF 2,700 SQUARE INCHES.
4. 290 PSI ADDITIONAL LOADING MAY BE EXPECTED ON THE DOWNSTREAM SIDE FOR A 2-KNOT LATERAL CURRENT.

Fig. 15.4 DSRV rescue scenario (top). Details of typical submarine rescue seat (bottom).



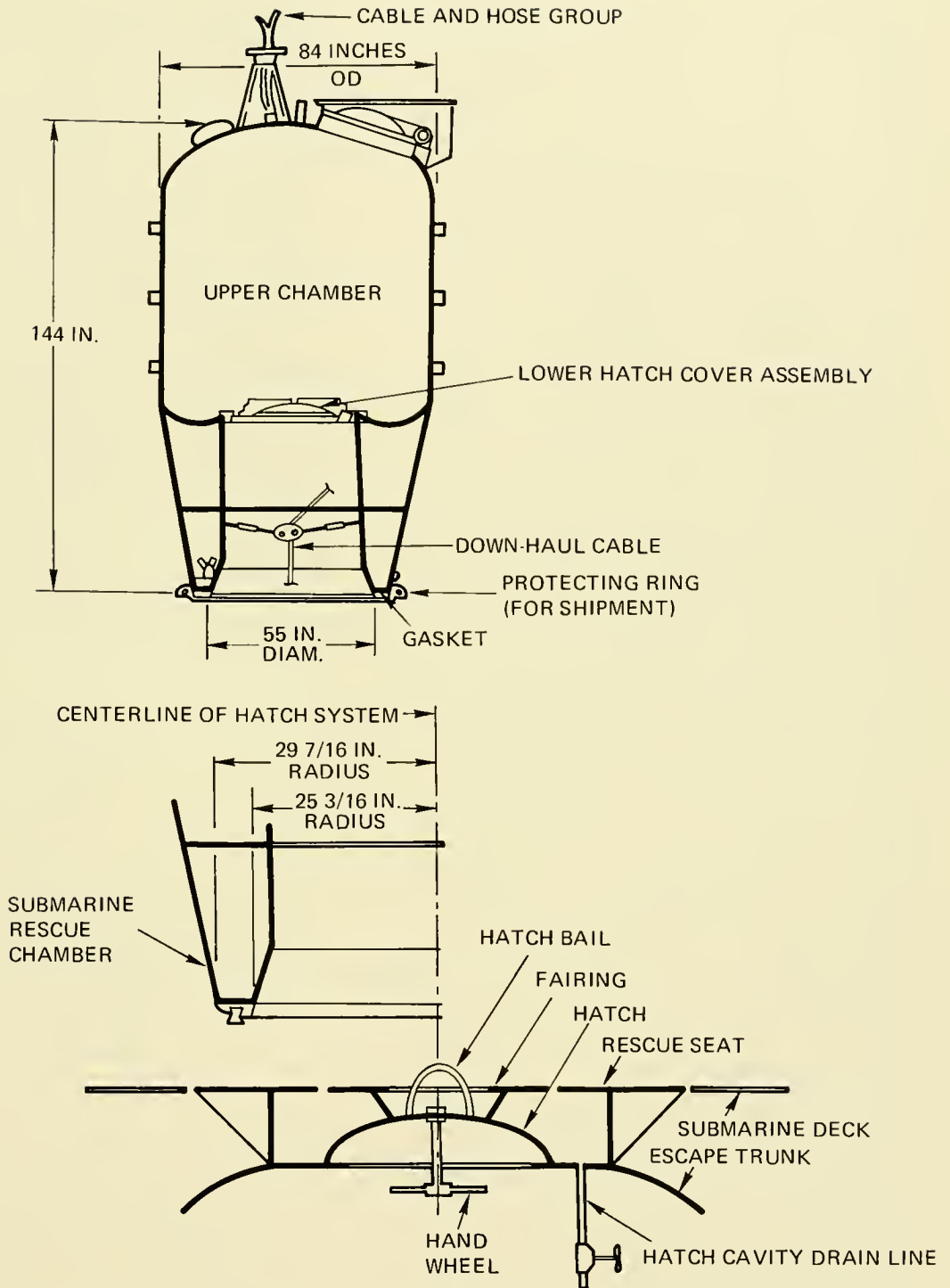

**NOTE:**

THE LOAD P THE SRC WILL EXERT ON THE RESCUE SEAT AFTER DEWATERING THE LOWER CHAMBER IS HYDROSTATIC PRESSURE ACTING OVER THE SEALED AREA PLUS THE SRC NET BUOYANCY AND THE TENSION IN THE HAULDOWN CABLE.

Fig. 15.5 Submarine rescue chamber (top). Typical disabled submarine rescue seat (bottom).

to 850 feet. In theory, the chamber is operated as follows: A stricken submarine releases a buoy to the surface which is attached to a  $\frac{7}{8}$ -inch-diameter wire. The **ASR** establishes a four-point moor over the submarine and brings the buoy aboard where it cuts it off and attaches the wire to a reel on the base of the **SRC**. The chamber is then lowered into the water and its two operators reel the positively buoyant chamber down to the submarine where a hemispherical skirt on the bottom of the chamber mates with a compatible surface surrounding the submarine's hatch. At this stage the operators blow water out of the mating skirt and, to bring pressure in the mating skirt down to atmospheric, the interior of the skirt is vented to the surface. Two separate air hoses lead from the **ASR** to the chamber: One hose is used solely to vent the skirt and the second hose supplies air to power the downhaul reel, provide breathing gas and blow out the mating skirt. Although those functions are controlled by the personnel within the chamber, they must rely on the surface for high pressure air. With the interior of the skirt dry and at atmospheric pressure, the hatch in the bottom of the hull and the hatch on the submarine can now be opened for ingress of trapped personnel. In addition to the two operators, six rescues are routinely accommodated, but in an emergency far more may squeeze into the 7-foot ID, 7-foot-high cylinder. To ascend, the hatches are shut, seawater is readmitted to the skirt to break the pressure differential and it unreels its way to the surface. Where depth allows, a diver can attach a suitable cable to the hatch to perform the same function. Similar to the **DSRV**, the **SRC** requires a flat, steel base at least 4 feet 7 inches across and suitably machined to effect a watertight seal. In addition, the submarine's hatch cover must have a point on it to which the downhaul cable can be attached.

Both the **DSRV's** and the **SRC** can accommodate hatches up to 28 inches in diameter which will allow them to open 80 degrees. In order to accommodate either the **DSRV** or the **SRC**, a submersible must meet the requirements listed below.

1) **DSRV Requirements:** The dimensions of the **DSRV** skirt are shown in Figure 15.6.

Since the submarine's hatch must open upward into the skirt cavity while mated, its dimensions are critical.

The skirt rests on the rescue seat, which is a reinforced circular steel area surrounding the escape hatch. The rescue seat must have a minimum outer diameter of 65 inches and a maximum inner diameter of 44.5 inches. Additionally, the area beyond the rescue seat must be in the same plane as the rescue seat and clear of obstructions and projections out to a diameter of 89 inches to accommodate the **DSRV** shock mitigation ring. The strength required of the rescue seat is dependent upon the depth of the rescue operation. Figure 15.4 describes the loads applied to the stricken submarine.

The skirt mating flange contains a rubber gasket designed to seal rescue seat irregularities up to 0.150 inch. The surface of the rescue seat must thus be flat within 0.150 inch at all rescue depths and under the loads imparted by the **DSRV**.

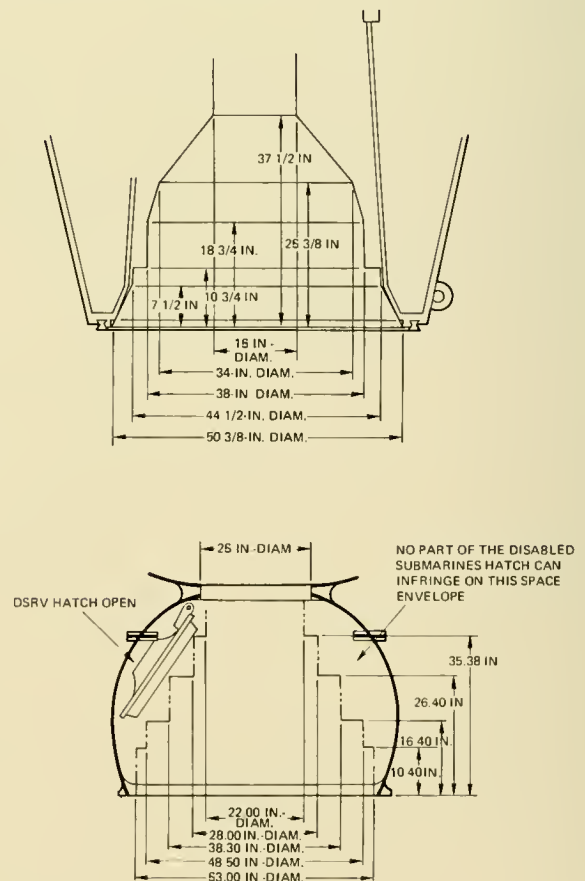

Fig 15.6 DSRV skirt (bottom) and SRC lower chamber (top) dimensions

The **DSRV** is equipped with a haul-down system to assist it in mating in unfavorable underwater currents. The system consists of a winch and cable located in the **DSRV** skirt. A grapnel hook at the end of the cable is lowered and attached to the escape hatch. The winch is then operated to haul the **DSRV** down to the rescue seat. A suitable bail must be provided on the escape hatch.

It is necessary to have an air sampling and pressure equalization valve operable from outside of the submersible. The fitting must be located within the area covered by the skirt. Its purpose is to permit sampling of the air within the submersible for toxicity, temperature, and radioactivity, and to equalize pressure between the **DSRV** and the submarine. The **DSRV** is capable of operating with an internal pressure of 5 atmospheres absolute.

2) **SRC Requirements:** The **SRC** mating surface is a construction around the bottom of the lower chamber consisting of a rubber gasket and a steel retaining ring. The 1<sup>3</sup>/<sub>4</sub>-inch-wide pure rubber gasket at the mating surface provides a seal against sea pressure when the **SRC** is mated to the submarine.

The disabled submersible must have an equivalent mating surface around its hatch to be used for the rescue. The strength required of the rescue seat depends on the depth at which the mating will be performed. Since the system has a depth capability of 850 feet, the static load on the rescue seat after dewatering and venting of the lower chamber will be the hydrostatic pressure at 850 feet acting over the corresponding area exposed to the lower pressure plus the net buoyancy of the chamber and the force exerted by the pressure and the force exerted by the haul-down cable. Seat loading of 3,640 psi will therefore result if the mating surfaces are perfectly flat. A safety factor should be utilized to allow for surface irregularities, corrosion, and minor impact loads. The strengthened area of the rescue seat should have a minimum outside radius of 35 inches and a maximum inside radius of 23 inches, both as measured from the center of the submersible's hatch.

The rubber gasket at the **SRC** mating surface is designed to seal rescue seat surface irregularities such as scratches, nicks, and

waviness. The gasket is capable of sealing gaps up to 1/8 inch. The seal limitation requires the rescue seat to be flat within 1/8 inch. Figure 15.5 (bottom) illustrates the mating of an **SRC** with a typical submarine hatch.

Projections and obstructions above the hull of the disabled submarine in the vicinity of the rescue seat present hazards to the **SRC** mating surface and seal. Damage to these systems could prevent mating. In the area of the submersible's rescue hatch there can be no projections above the submarine hull which would impact an **SRC** descending vertically to a submersible that is inclined 30 degrees from the vertical in either the fore-and-aft or athwartships planes, or both.

If the haul-down cable is not permanently attached to the submersible, a strengthened connection point must be available at the hatch to permit hook-up of the down-haul cable by external means. The maximum depth at which this can be accomplished is a function of **ASR** maximum deep diving capability, and is generally around 400 feet. The connection point should be as nearly centered on the hatch as possible. The padeye or bail must be able to withstand a load of 12,500 pounds.

In addition to the cable connection point, two other requirements are placed on the submarine hatch. To permit egress from the submersible the hatch must be of such size to allow it to be opened, without interference, into the lower chamber of the **SRC** with the **SRC** mated to the submersible. **SRC's** lower chamber minimum internal clearances are shown in Figure 15.6.

The hatch area should include tiedown attachment points so that the **SRC** can be firmly secured to the submersible before the haul-down cable is slacked. The **SRC** has four hold down rods with shackles on their ends which will be emplaced by the rescue crew before the hatch is opened. The tiedown points must be padeyes or staples with openings through which the 1<sup>1</sup>/<sub>8</sub>-inch-diameter pins of the hold down rod shackles can be passed and secured. They must be placed around the submarine's hatch inside the area of **SRC**/submarine mating (orientation is not critical). The tiedown attachments must be individually capable of withstanding a holding down load of 10,000 pounds.

In the event that communications with a disabled submersible cannot be established, the quality of the atmosphere within the submersible must be determined before its hatch is opened. Failure to do so could result in harm to the **SRC** operators from heat, toxicity, or radioactivity. It is therefore necessary to have an air sampling fitting with a stop valve operable from outside of the submarine's pressure hull. The fitting must be located within the area covered by the **SRC's** lower chamber, preferably built into the submersible's hatch.

The **SRC** can, under emergency conditions, equalize pressures between the disabled vehicle and the **SRC** up to 290 feet equivalent depth. The **SRC** operators can also determine if internal submersible pressures exceed 290 feet equivalent depth, but cannot effect a rescue at pressure greater than this. Internal submersible pressures in excess of 290 feet equivalent depth represent a danger to an **SRC** and are sufficient reason to abandon the rescue mission.

The **SRC** carries portable ballast consisting of lead pigs. Water ballast cans can also be carried as portable ballast. In order to maintain proper **SRC** buoyancy, the portable ballast is placed in the submersible after the rescuees are taken aboard.

In view of the requirements outlined above, no past or present manned submersible (military or civilian) was or is amenable to rescue by the **DSRV** or **SRC**; this includes the **DSRV's** themselves. Retrofitting of submersibles to accommodate these rescue systems is technically feasible in most cases, but the cost and degradation in vehicle maneuvering and handling characteristics would be unacceptable to vehicle owners. Some appreciation for the cost involved may be gained by considering that it requires some \$150 thousand to modify a military submarine for rescue. Consequently, the U.S. Navy has concluded that the only feasible means of rescuing occupants of a stricken submersible is by recovering (salvaging) the vehicle.

## Recovery

Three situations can be foreseen where a submersible is unable to surface: 1) It is too heavy to ascend, *e.g.*, **PISCES III**; 2) it is

restrained from ascending due to an entanglement, *e.g.*, **JOHNSON SEA LINK**, or overhead obstruction, and 3) the occupants are unable to function. In such cases the rescue device must be capable of attaching a suitable line for surface recovery or freeing, *i.e.*, cutting, the vehicle from its obstruction. To accomplish these tasks the rescuing device must possess a manipulative capability of some degree, it must be maneuverable, and it must provide its operator with a direct or remote view of the submersible. There are three systems which provide those capabilities; divers, manned submersibles and unmanned devices. It is not the intent to compare these three capabilities; each one offers unique attractions which may be the best answer to a specific situation. Instead, the present and near-future capabilities of each system will be simply listed. In the final analysis, the individual in charge of a rescue operation will have to decide for himself what capability is the best, assuming all are available.

The following capabilities were taken from a presentation by Captain Edward Clausner, Jr., USN, at the Marine Technology Society's 8th Annual Conference and Exhibition, Washington, D.C., in September 1973 and entitled Rescue, Recovery, and Salvage of Submersibles. As Captain Clausner explained, the present assets for recovery not only reflect Navy capabilities, they include essentially all U.S. capabilities, both commercial or military, because the Supervisor of Salvage maintains a contract with a civilian firm to provide any assistance available in a Naval emergency from the commercial sector. This assistance is also available to any non-military submersible in an emergency; therefore, the total assets of the U.S. are at the stricken submersible's service.

## Divers

There are literally thousands of Navy divers available who can be quickly deployed and diving with MK V Air Hard Hat rigs to 190 feet while breathing compressed air. The advantage they offer, by virtue of their mobility, is severely hampered by the disadvantages of short bottom time and long decompression time. Below 190 feet the Navy would deploy one of two systems: the **MK V Helium**

**Hard Hat, or the Deep Dive System (MK I and MK II).**

**MK V Helium Hard Hat: (Fig. 15.7)**

This system relies upon a hard hat and umbilical to a surface support ship and uses helium-oxygen breathing gasses. The bottom time is measured in minutes, but under ideal conditions a depth of 450 feet is attainable. Ideal conditions include a calm sea, the support ship in a four-point moor, adequate medical facilities and experienced divers. Normal diving with this system is conducted to 300

feet and the capability exists aboard every U.S. Navy ASR; these are stationed throughout the world and cruise at a speed of 13 knots.

**Deep Dive Systems MK I and MK II: (Fig. 15.8)**

Also using helium-oxygen breathing gas mixtures, the Navy's Deep Diving Systems are for saturation diving and theoretically provide extended bottom time to 1,000 feet deep. The systems are presently located on the east (Norfolk, Va.) and west (San Diego,

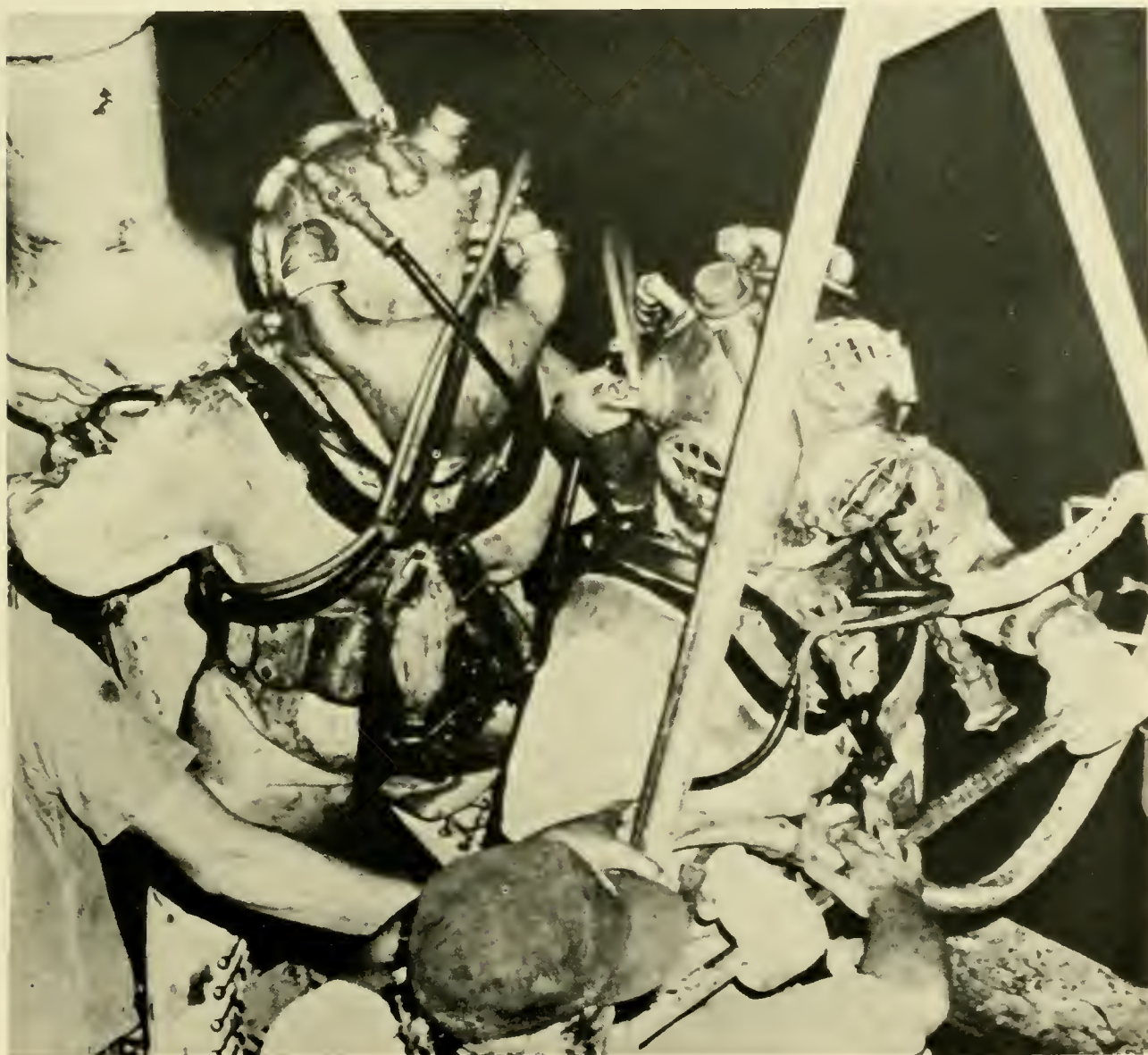
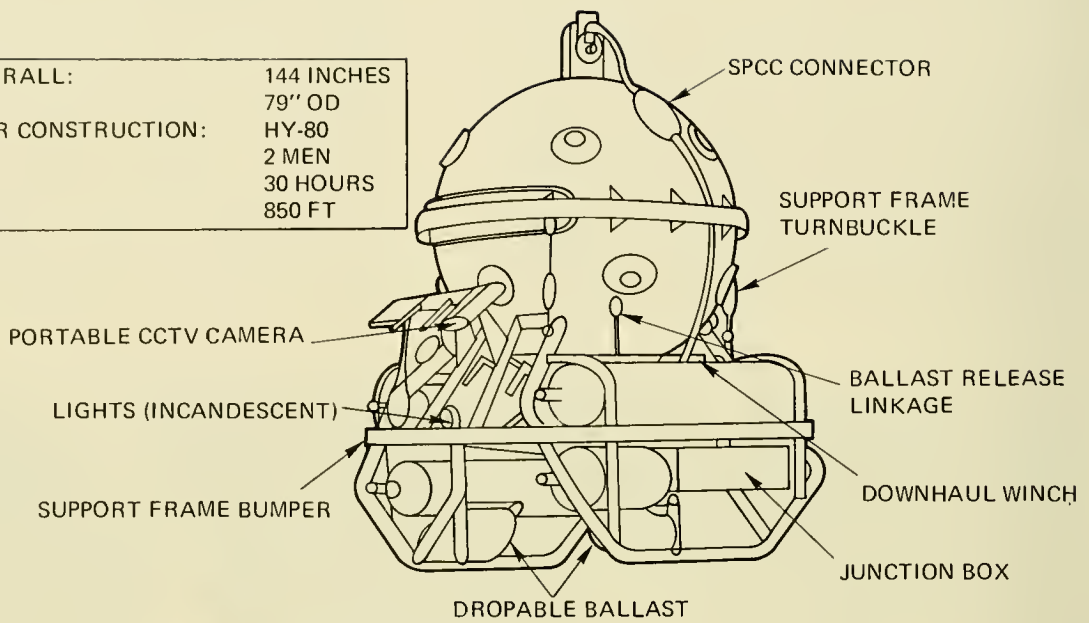

Fig. 15.7 MK V Helium Hard Hat. (U.S. Navy)

HEIGHT-OVERALL:	144 INCHES
DIAMETER:	79" OD
MATERIAL OR CONSTRUCTION:	HY-80
CAPACITY:	2 MEN
DURATION:	30 HOURS
DEPTH:	850 FT



PERSONNEL TRANSFER CAPSULE

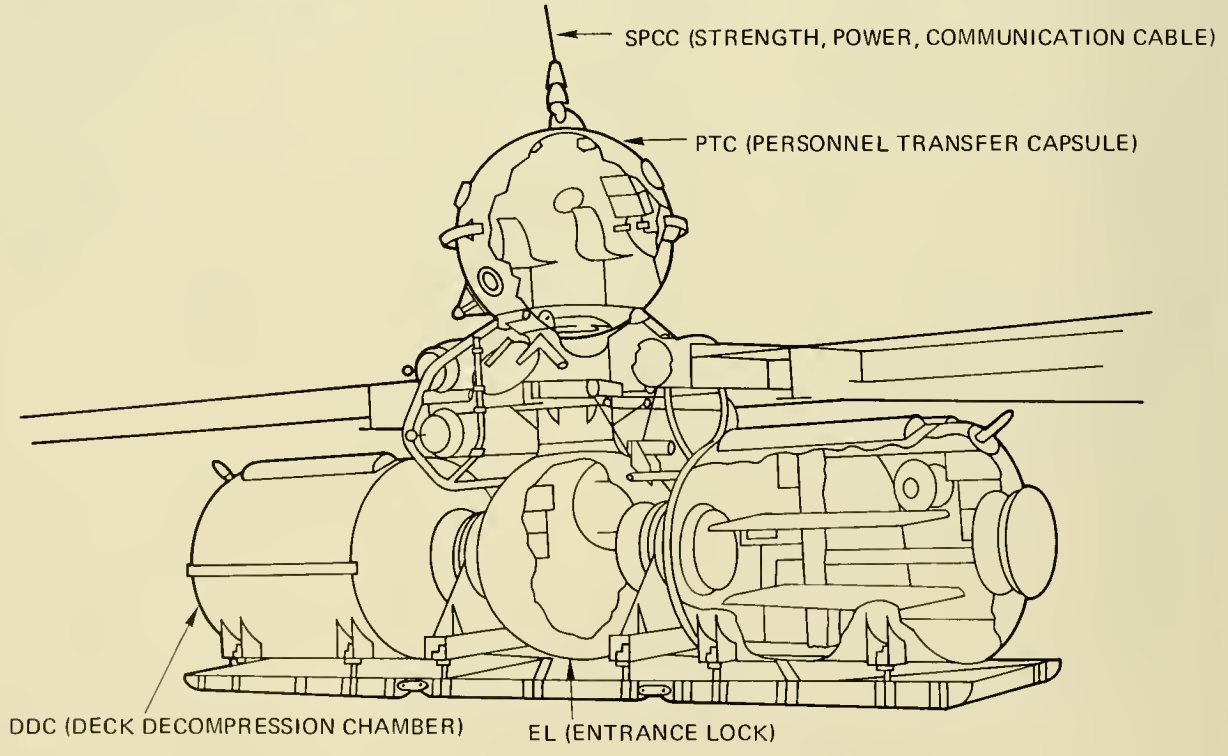

Fig. 15.8 Mark I DDS.

Calif.) coasts of the U.S. and are designated **MK I** and **MK II**, respectively. The **DDS-MK I** supports two 2-man teams of divers through a 14-day mission; the **DDS-MK II** is designated for saturation diving (*i.e.*, where one spends about 24 hours at depth) and supports two 4-man teams for an extended mission time. Both systems require a four-point moor to operate and rely on an **ASR** to plant this moor. The **MK I** is barge-mounted and towed at a speed of 3-5 knots; the **MK II** is aboard the **IX-501** which is capable of about 8 knots. A **MK II DDS** is now aboard the newly launched **ORTOLANE (ASR-22)** and **PIGEON (ASR-21)**, and both are completely independent in deploying the system and capable of 18 knots. The system will undergo operational evaluation in December 1973 and is tentatively scheduled to be operational aboard **PIGEON** by June 1974. The **MK II** aboard **ORTOLANE** is scheduled to be operational 6 months later (Jan. 1975).

There are also thousands of Navy divers trained in the use of compressed air scuba to depths of 130 feet and they are available in the event of an emergency. One can find exceptions to the depths noted above and show cases where they have been exceeded. In extreme cases, there is no doubt that one might exceed these depths to effect a rescue, but to plan on such an extension before the emergency occurs may result in the loss of additional life in the course of saving others.

As stated, the above describes U.S. Navy diving capabilities; for a detailed description of commercial, as well as Naval capabilities, the reader is referred to reference (17) which summarizes the current state-of-the-art in ambient diving techniques and equipment. It is sufficient to note that Galerne (18), as early as 1971, stated that 750-foot working dives in 28°F water would be no problem for his corporation, International Underwater Contractors of New York, and that the French firm COMEX conducts full working dives at 1,500 feet ". . . on an almost *hohum* basis." One must realize, however, that such dives are supported by extensive surface equipment which requires time for transportation and mobilization on the scene. Ambient diving to 500 or 1,500 feet consists of far more than merely donning on

scuba gear and plunging in. Support facilities, hoses, cold water protection, medical facilities, a well-trained and highly varied team and a host of other requirements must be met before the dive commences. As we have seen, 80 percent of all submersibles have no more than 48 hours of life support, a very short time to marshal the assets required for employing the deep, ambient-pressure diver.

### Manned Submersibles

There are seven operational manned submersibles in the U.S. Navy, with depth capabilities ranging to 20,000 feet. In addition to these are some 25 other privately-owned vehicles believed operating full or part time in the United States. This latter figure is likely to be conservative, because it assumes that all vehicles are known and it includes only one from a class of vehicles, such as the **K-250**. A further difficulty in tabulating submersibles is that there is no requirement to register their building or report their operations. Hence, the numbers of submersibles herein should be considered as best estimates. The operational status, home port and even the owner of a given submersible is subject to rapid change.

Table 15.1 presents the characteristics of submersibles believed operating throughout the world. "Operating" in this sense implies that the submersible can be ready to dive within 2 days to 1 week, in spite of the fact that it may not have dived for some time.

Table 15.1 can be viewed in two ways: It reveals not only the capabilities for rescue, but also the candidates for rescue. Consequently, the following is both a list of potential rescuers and rescuees:

0-1,000 feet:	50% (30 vehicles)
1,000-2,000 feet:	27% (16 vehicles)
2,000-6,500 feet:	15% (9 vehicles)
6,500-36,000 feet:	10% (5 vehicles)

Regarding manipulator capability, of the 55 vehicles, where data is available, 65 percent have one or two manipulators of widely varying ability. As a means of transportation and support of diver-rescuers, eight have a lock-out feature.

### Unmanned Vehicles

Unmanned vehicles of the **CURV** variety

TABLE 15.1 OPERATING SUBMERSIBLES (NOV. 1973)

Country	Submersible	Home Port	Oper. Depth (Ft)	Weight (Tons)	Crew	Life Support (Man-Hrs)	Manipulators	Diver Lock-out	Hatch Diam. (in.)
Canada	AUGUSTE PICCARD	Vancouver, BC	2,500	185	44	2112	0	No	30.1
	PISCES IV	Victoria, BC	6,500	10	3	76	2	No	19.5
	PISCES V	Vancouver, BC	6,500	10	3	76	2	No	19.5
	SOL-1	Halifax, N.S.	2,000	14.3	6	204	2	Yes	25
	SEA OTTER	Vancouver, BC	1,500	3.15	3	192	1	No	19
	AQUARIUS I	Vancouver, BC	1,200	4.5	3	108	1	No	19
England	PISCES I	Barrow-in-Furness	1,200	7.5	2	100	2	No	18
	PISCES II	Barrow-in-Furness	2,600	12	3	100	2	No	19.5
	PISCES III	Barrow-in-Furness	3,600	12	3	100	2	No	19.5
	VOL-L1	Barrow-in-Furness	1,200	13	4	192	1	Yes	22
	PC-8B	London	800	5.5	2	48	1	No	24
France	ARCHIMEDE	Toulon	36,000	61	3	108	1	No	17.7
	SP-350	Monaco	1,350	4.2	2	96	1	No	15.75
	SP-500 (2@)	Monaco	1,640	2.65	1	12	1	No	15.75
	SP-3000	Marseilles	10,082	8	3	144	1	No	15.75
	SHELF DIVER	Marseilles	800	8.5	4	172	0	Yes	23
	GRIFFON	Toulon	1,970	12	3	100	1	No	NA
Netherlands	NEREID 330	Schiedam	330	11	3	96	2	No	22.8
	NEREID 700	Schiedam	700	7.5	2	NA	1	Yes	22.8
Italy	PC5C	NA	1,200	5.75	3	180	0	No	23
	PS-2	Milano	1,025	6	2	72	1	No	NA
	TOURS 66	Sardinia	984	10	2	96	1	No	26.4
Japan	HAKUYO	Tokyo	984	6	4	144	1	No	23.6
	KUROSHIO II	Hokkaido	650	12.5	4	96	0	No	21.2
	SHINKAI	Tokyo	1,968	100	4	192	1	No	19.6
	YOMIURI	Tokyo	972	41	6	492	1	No	25
Taiwan	TOURS 64	Taipei	948	10	2	96	1	No	26.4
United States	ALVIN	Mass.	12,000	16	3	216	1	No	19
	BEAVER	New York	2,000	17	4	360	2	Yes	25
	DEEP QUEST	San Diego	8,000	52	4	204	2	No	20
	DEEPSTAR-2000	Annapolis, Md.	2,000	8.75	3	144	1	No	15.75
	DSRV-1 & 2	San Diego	5,000	38	27	729	1	No	25
	GUPPY-1	Chester, Pa.	1,000	2.5	2	72	0	No	20
	JOHNSON SEA LINK	Ft. Pierce, Fla.	1,000	9.5	4	72	0	Yes	24
	NAUTILETTE (3@)	Ill., Mich., Inc.	100	1.2	2	2	0	No	22
	NEKTON (3@)	Irvine, Calif.	1,000	2.35	2	48	1	No	18
	NR-1	New London, Conn.	NA	400	7	45 days	NA	NA	NA
	PC3-X	Austin, Tex.	150	2.3	2	16	0	No	19
	PC-3A (2@)	Hawaii	300	2.3	2	20	0	No	19
	PC-14	Galveston, Tx.	1,200	5	2	60	1	No	19
	QUESTER I	Brooklyn, N.Y.	650	NA	NA	NA	NA	No	NA



TABLE 15.1 OPERATING SUBMERSIBLES (NOV. 1973) (Cont.)

Country	Submersible	Home Port	Oper. Depth (Ft)	Weight (Tons)	Crew	Life Support (Man-Hrs)	Manipulators	Diver Lock-Out	Hatch Diam. (in.)
United States	SEA CLIFF	San Diego	6,500	24	3	100	2	No	19.75
	SEA RANGER	Mt. Clemens, Mich.	600	8	4	120	2	No	20
	SNOOPER	Torrance, Calif.	1,000	2.3	2	24	1	No	24
	STAR II	Honolulu	1,200	5	2	48	1	No	20
	SURVEY SUB I	Houston, Tex.	1,350	11.25	3	216	0	No	24
	TRIESTE II	San Diego	20,000	87.5	3	72	1	No	19.8
	TURTLE	San Diego	6,500	24	3	100	2	No	19.75
Soviet Bloc	SEVER 2	NA	6,562	NA	3	72	NA	No	NA
	GVIDON	NA	810	NA	4	24	NA	No	NA
	TINRO I	NA	984	NA	2	96	NA	No	NA
	DOREA	NA	NA	NA	1	NA	NA	NA	NA
West Germany	MERMAID I/II	New York	984	6.3	2	120	0	No	24
	MERMAID III/IV	New York	650	10.5	4	120	0	Yes	24

(Table 15.2) offer many capabilities of the manned vehicles, with the added advantage of virtually unlimited endurance and no man in the system to add another rescuer. On the other hand, they all have a cable to the surface which may foul or limit maneuverability and they are subject to the same electro-mechanical malfunctions as the manned submersible.

The U.S. Navy's present and near-future capabilities in tethered unmanned vehicles is presented in Table 15.2; it is germane to note that *CURV III*, in addition to *PISCES II* and *V*, attached a lift line to the stricken *PISCES III* in its rescue from 1,575 feet in September 1973.

To the capabilities of the unmanned devices must be added the *ALCOA SEAPROBE* (Fig. 15.9). Operated by Ocean Search, Inc., a subsidiary of Aluminum Company of America, *SEAPROBE* offers the advantages of an unmanned vehicle coupled with a lift capacity of 200 tons from 6,000 feet. A list of *SEAPROBE*'s characteristics is presented in Table 15.3 and a detailed discussion in reference (19).

The working end of the *ALCOA SEAPROBE* system is located at the end of a pipe string made of 60-foot segments of drill pipe

threaded together to reach the depth required. A cable affixed to the pipe provides the necessary electrical power, telemetry control signals, and data transmission circuits between the shipboard control consoles and the sensor systems.

The basic search "pod" deploys side-scan sonar to sweep a 2,400-foot path along the sea floor. The pod is configured with forward looking sonar, television, still camera, lights and a releasable acoustic beacon to use in marking specific targets. Heavy object recovery devices are available which utilize electro-mechanical and hydraulic systems for closure and holding control. Precise positioning of the recovery device with respect to the target is by sonar and transponder sensing devices in concert with remotely monitored television and target illumination systems.

The *ALCOA SEAPROBE* was on the scene of the *JOHNSON SEA LINK* tragedy, but recovery was completed before it could be brought into play.

Such is the variety of devices which may be employed to retrieve a distressed submersible. In the final analysis, the rescuing apparatus may well be something never intended for such purposes. In the *JOHNSON SEA LINK* incident, both divers and a

TABLE 15.2 U.S. NAVY TETHERED UNMANNED SUBMERSIBLES

	CURV II	CURV III	RUWS	SNOOPY	SCAT
Weight, Lb	3,000	4,500	4,300	50	400
Length, Ft	15	15	10.7	3.6	6
Max. Depth, Ft	2500	7000	20,000	100	2000
Radial Excursion, Ft	600 (Whip)	600 (Whip)	1000 (Whip) *	200	500
Tether, In. (OO)	1.25 (Buoyed)	1.25 (Buoyed)	0.9 (Buoyant)	0.75	5/8 (Buoyant)
Propulsion, Hp	30 (Elec)	30 (Elec)	15 (Hydr)	0.3 (Hydr)	5 (Hydr)
Speed, Knots	3	2	3	2	2
Sonar	CTFM, PPI	CTFM, PPI	CTFM, PPI	None	Head Following Aural CTFM
TV Camera	2	2	Head Following	1	Head Following Stereo
Manipulator	4 Function	7 Function	**	Grasp Function	2 Function

\*From Primary Cable Termination (PCT).

\*\*Master-Slave Manipulator and Rate-Controlled Grabber.

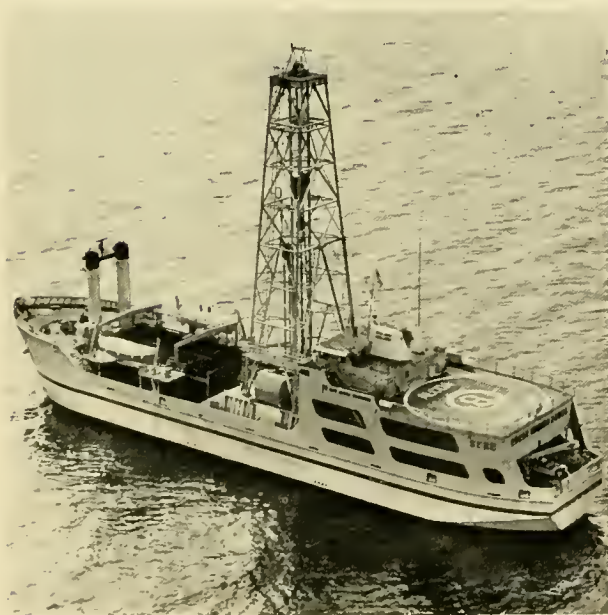

Fig. 15.9 The ALCOA SEA PROBE. (Ocean Search Inc.)

manned submersible (*PC-8*) were unsuccessful. At the eleventh hour, a device used by the Naval Ordnance Laboratory, Ft. Lauderdale, Florida, to inspect underwater hardware (Fig. 15.10) was affixed with a danforth anchor and “conned” by the submersible’s pilot to a point where the anchor fortuitously hooked the submersible and the *R/V A.B. WOOD II* pulled it free.

## TIME-LATE

In view of these, and other national and international assets, it would appear that rescue is inevitable; unfortunately this is not the case. Except for the *DSRV*’s (which are not yet considered operational), none of these assets are on a standby basis to respond to distressed submersibles and all of them may be either working elsewhere or inoperative when the emergency arises. Additionally, many may find that transportation to the disaster scene is unavailable. The problem, as Captain Clausner termed it, is

TABLE 15.3 ALCOA SEAPROBE CHARACTERISTICS

Length	243 feet
Beam	50 feet
Draft	14 feet (Propeller depth)
Displacement	1700 tons
Speed	10 knots
Range	6,600 miles
Endurance	45 days
Main Power	Two 800 kW diesel-electric generators
Auxiliary Power	Two 250 kW diesel-electric generators
Propulsion	Two Voith-Schneider cycloidal omnidirectional propulsion units
Auxiliary Deck Equipment	Two 5-ton cranes Oceanographic winch-interchangeable drums
Ship Control	Decca ship control consoles on bridge and in search/recovery control center
Primary Ship Construction Material	5456-H117 aluminum plate 5456-H111 aluminum extrusions
Derrick	Height: 132 feet (above water line) Capacity: 250-ton hook load with safety factor of 2 Material: 6061-T6 aluminum tubing 5456-H321 aluminum plate
Drawworks	EMSCO 800 with 600 hp motor generator power supply for DC control
Pipe	4½" external upset-internal flush Sections 60 feet in length
Pipe Handling	Semi-automatic pipe handling system
Berthing	All spaces air conditioned Crew – 30 Scientific party – 19

TIME-LATE. Essentially, TIME-LATE refers to the passage of time involved from the occurrence of an event (disabling of the submersible) to the point where rescue is no longer possible. In a submersible "time" begins when the hatch is closed, and "late" is invoked when life support expires. In a hypothetical situation, from the moment the hatch is closed the following events occur before rescue:

- 1) Descend and work for some period of time
- 2) Emergency occurs: Evaluate and make decision whether or not additional help is required
- 3) Report emergency
- 4) Ascertain availability and martial assets
- 5) Transport available assets to emergency scene
- 6) Locate submersible
- 7) Deploy assets, attempt rescue.

With a general limit of 48 hours the chances

of all the above occurring before "late" is reached are indeed slim. Let us examine one of the most recent incidents in the light of TIME-LATE.

**PISCES III Incident:**

The Vickers Oceanics Ltd. submersible was in the process of retrieval when the aft machinery sphere hatch cover was torn off and the sphere flooded. The vehicle sank to 1,575 feet and landed stern-first on the bottom some 0.95 to 1.5 tons heavy and 150 nm southwest of Cork, Ireland. In attendance at the time of the incident was the support ship **VICKERS VOYAGER**. The dive commenced at 0115 hours on 29 August 1973 and life support for the two occupants was subsequently estimated to last ". . . well past midday" on 1 September (6), a total of 85.75 hours assuming ". . . well past midday" to be 1500 hours. This value was reduced by 8 hours 3 minutes due to use of life support during the dive to 77 hours 42 minutes. The major assets used in the recovery were:

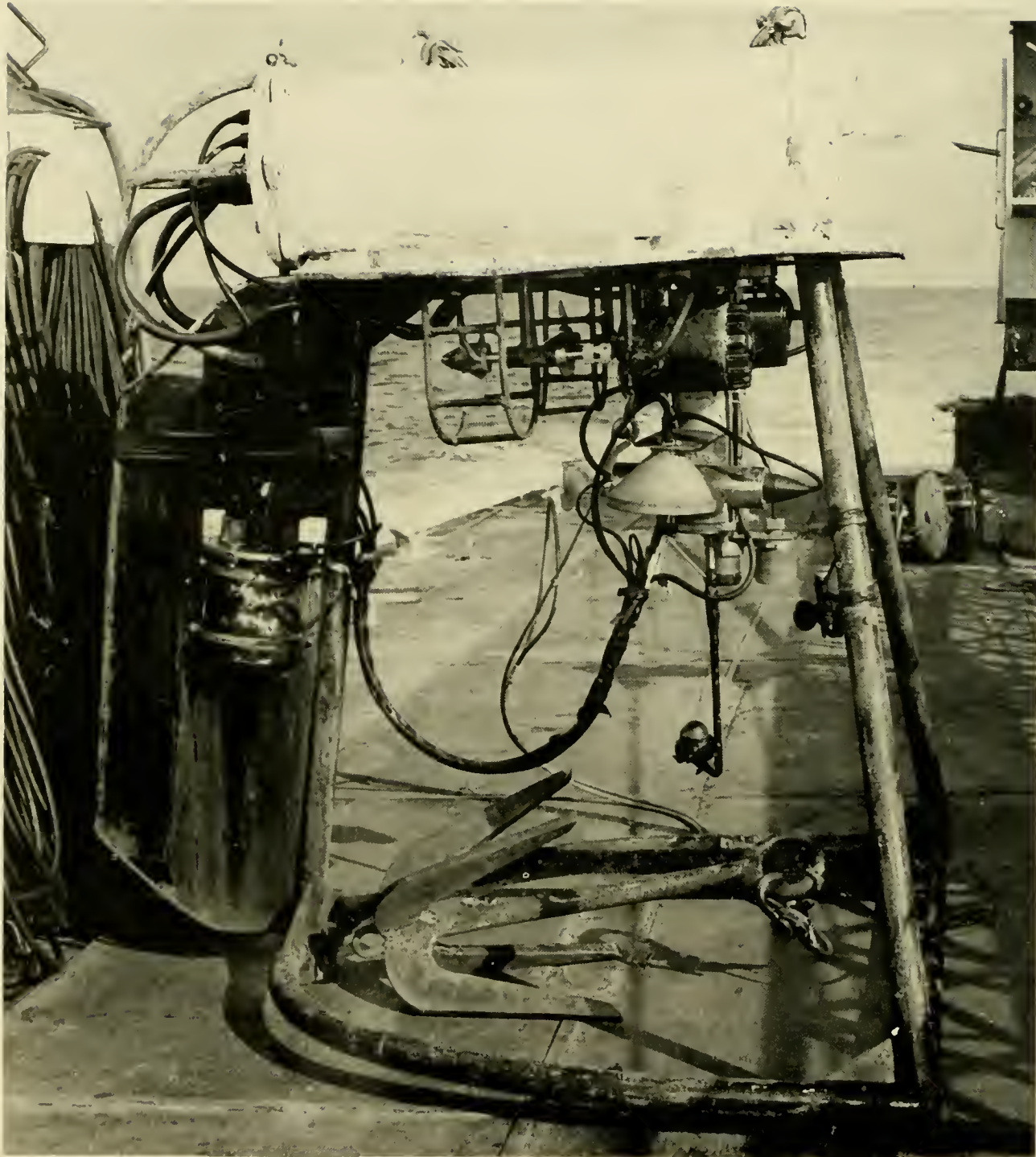

Fig 15 10 On 18 June 1973 this Naval Ordnance Laboratory apparatus was lowered to 350 feet from the research ship *A. B. WOOD II* and pulled the *JOHNSON SEA LINK* free of its entanglement in a scuttled destroyer. Equipment on the towed device includes a television camera, an underwater light, compass and two battery-powered motors. The grapnel was attached for the *SEA LINK* recovery. (U.S. Navy Ord. Lab.)

- a) **VICKERS VOYAGER**: Support ship for two rescue submersibles
- b) **RFA SIR TRISTAM**: The nearest available ship to which the Vickers communication team transferred while **VICKERS VOYAGER** transited to Cork to pick up the two submersibles **PISCES II** and **PISCES IV**. This vessel was relieved of its duties by **HMS HECATE** arriving some 11 hours after **SIR TRISTAM**.
- c) **PISCES II**: A 3,500-ft submersible belonging to Vickers and working at the time some 150 miles from England aboard **VICKERS VENTURER** in the North Sea. This vehicle was transferred to the rig supply vessel **COMET**, carried to Teasdock, England, thence to Teeside Airport where it was loaded aboard a Hercules aircraft and transported to Cork for loading aboard **VICKERS VOYAGER**.
- d) **PISCES V**: A 6,500-ft submersible belonging to International Hydrodynamics, Ltd., Vancouver, B.C. and working on the east coast of Canada. It was subsequently airlifted from Halifax, N.S., to Cork and thence aboard **VICKERS VOYAGER**.
- e) **CURV III**: An unmanned, tethered, self-propelled vehicle located in San Diego, California and belonging to the U.S. Navy. **CURV** was subsequently airlifted to Cork and loaded aboard **JOHN CABOT** for transportation and deployment to the scene.
- f) **JOHN CABOT**: A Canadian cable laying vessel under contract to the U.S. Navy and tied up at Swansea, Wales. **JOHN CABOT** would serve as support ship for **CURV III** and as retrieval ship for **PISCES III**.
- g) **AEOLUS**: A U.S. Navy salvage ship working in the area and ordered to the scene to assist where possible.

The salvage scheme decided upon for **PISCES III** was to insert "toggle" hooks into its open machinery sphere and lift it up from the surface. The toggle hooks were fabricated by Vickers in England immediately upon notification of the emergency. Eventually, three lines were attached to **PISCES III**: The first (4-in. polypropylene) was by **PISCES V** to the port motor guard (this line

was initially attached to the lift padeye, but fell out and hooked into the guard); the second (3<sup>1</sup>/<sub>2</sub>-in. polypropylene) was a toggle inserted into the machinery sphere by **PISCES II** and the third (6-in. braided nylon) into the same location by **CURV III**. At 60 to 100 feet deep, a line (4-in. braided nylon) was passed through **PISCES III**'s lift padeye by divers, and on the surface a 16-ton snap hook and 25-ton wire combination, plus flotation bags, were also attached by divers. Throughout the entire incident all major assets (manned and unmanned vehicles) experienced malfunctions. This could be anticipated in any like incident and the details are unnecessary for this narrative. Significant, however, was **PISCES III**'s life support: 15 minutes after landing on the bottom life support was estimated to last through 0800 hours on 1 September, at 1251 hours on 31 August it was estimated to last until 1200 hours, and finally estimated at 0830 on 1 September to last until well past midday. The builder's (International Hydrodynamics) advertised life support for this submersible is 72 hours; Vickers Oceanics (the vehicle's owner) stated (in an advertising brochure) that it was about 60 hours. The additional 13 to 25 hours was either; a) always there or b) obtained by controlled breathing and limited movement of the occupants.

The major events of this rescue are shown in Table 15.4 and the location of lift lines in Figure 15.11. With approximately 1 hour and 43 minutes of life support remaining, the crew of **PISCES III** can be thankful they were not 250 miles, rather than 150 miles from Cork. A mere 3 or 5 hours longer transiting time from Ireland to the emergency scene could have measured the difference between life or death.

## REFERENCES

1. Pritzlaff, J. A. 1972 *Submersible safety through accident analysis*. Mar. Tech. Soc. Jour., v. 6, n. 3, p. 33-40.
2. Cousteau, J. Y. 1963 *The Living Sea*. Harper and Row, Publishers, New York.
3. Forman, W. R. 19 Oct 67 Naval Weapons Center, China Lake, Calif. (personal communication)

TABLE 15.4 PISCES III RESCUE EVENTS.

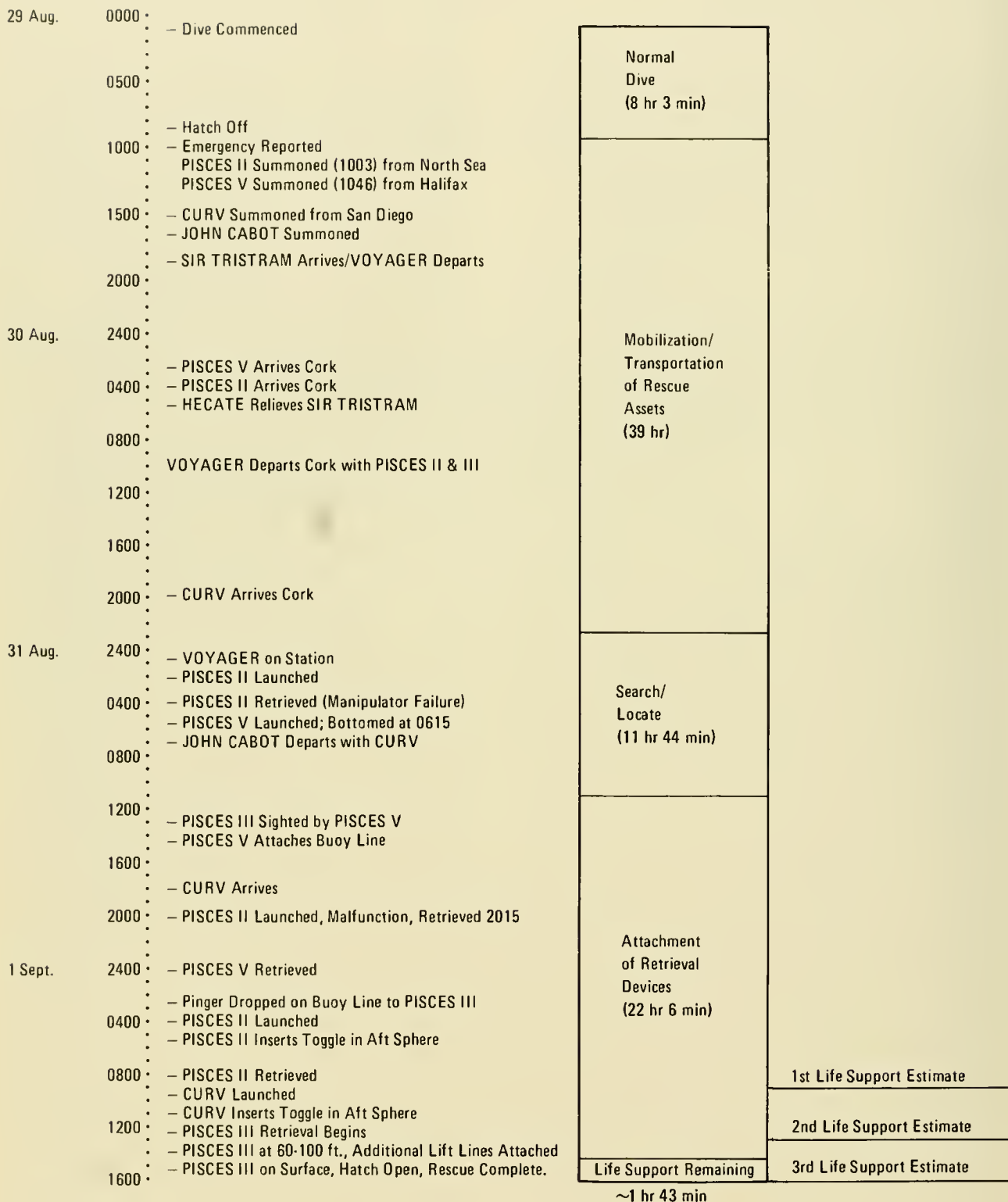

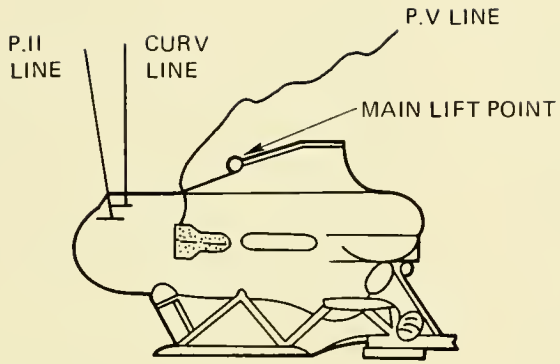

LIFT OFF BOTTOM

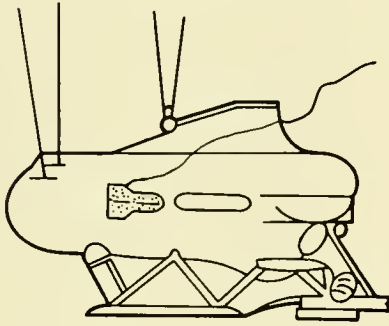

60 TO 100 FT  
ADD 1ST SHACKLE PLUS BIGHT OF 4" BRAIDED NYLON AT MAIN LIFTING POINT

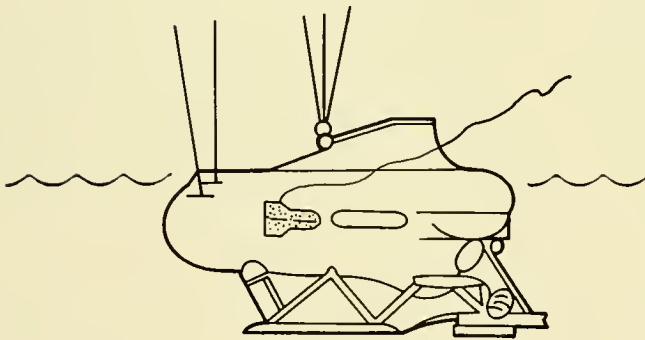

AWASH  
ADD 16 TON SNAPHOOK ON 25-TON WIRE-ROPE COMBINATION THROUGH SAME SHACKLE.  
(CUT 4" BRAIDED NYLON TO AVOID SNAPHOOK TROUBLE ONCE WEIGHT ON SNAPHOOK)

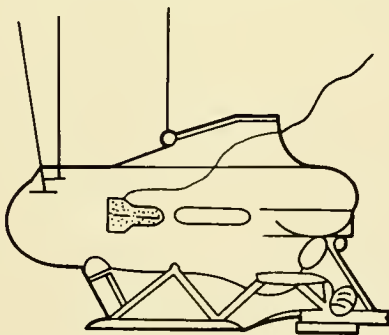

SKIDS CLEAR OF WATER  
PERSONNEL RECOVERED.



Fig. 15.11 Diagram of lifting lines on P.III, attitude of P.III not shown correctly to simplify diagram. [From Ref. (6)]

4. Kosonen, C., U.S. Naval Ship Engineering Center, Wash., D.C. (personal communication)
5. Booda, L. L. 1973 *Tragedy in the JOHN-SON-SEA-LINK*. Sea Technology, July 1973, p. 17.
6. Redshaw, Sir Leonard 6 Sep 1973 Account of the *PISCES III* rescue. Vickers Oceanic Ltd.
7. Busby, R. F. 1973 *Taxis to the Deep*. in, *World Beneath the Sea*. Nat. Geogr. Soc., p. 143-162. (revised edition)
8. Andrews, F. A. 1966 *Search operations in the THRESHER area-1964, Section II*. Naval Engineering Journal, Nov., p. 769-779.
9. Bline, D. 30 Oct 1973 Westinghouse Ocean Research Laboratory, Annapolis, Md. (personal communication)
10. Rainnie, W. O., Jr. 1971 *Equipment and instrumentation for the navigation of submersibles*. Underwater Jour., June, p. 120-128.
11. Merrifield, R. 1969 *Undersea Studies with the Deep Research Vehicle DEEP-STAR-4000*. U.S. Naval Oceanographic Office, IR No. 69-15.
12. Melson, L. B. 1967 *Contact 261*. U.S. Naval Institute Proceedings, v. 93, n. 6, p. 26-29.
13. Rainnie, W. O., Jr. 1968 *Adventures of ALVIN*. Ocean Industry, v. 3, n. 5, p. 22-28.
14. Busby, R. F., Hunt, L. M., and Rainnie, W. O. 1968 *Hazards of the deep*. Ocean Industry, v. 3, nos. 7, 8, 9, p. 72-77, 32-39, 53-58 respectively.
15. Bradley, R. F. Arctic Marine Ltd., North Vancouver, B. C. (personal communication).
16. Jebb, W. International Underwater Contractors, Inc., City Island, New York. (personal communication)
17. Kenney, J. E. 1972 *Business of Diving*. Gulf Pub. Co., Houston, Texas, 302 pp.
18. Galerne, A. 1971 *A diver looks back and into the future*. Offshore, Aug. 1971.
19. Sherwood, W. C. 1972 *Operational evaluation of a deep ocean search and recovery ship*. Preprints, 8th Annual Conference and Exhibition, Marine Technology Society, Wash., D.C., 11-13 Sept. 1972, p. 521-547.
20. Ocean Science 1974 Nautilus Press, Wash., D.C., v. 16, n. 6, (A weekly newsletter)
21. The Washington Post, 15 Oct. 1974.



**APPENDIX I**  
**UNIT EQUIVALENTS**

Exact relationships shown by asterisk(\*). See footnote (2).

**Area**

1 square inch .....	= 6.4516 square centimeters*
1 square foot .....	= 144 square inches*
	= 0.09290304 square meter*
	= 0.00002296 acre
1 square yard .....	= 9 square feet*
	= 0.83612736 square meter
1 square (statute) mile .....	= 27,878,400 square feet*
	= 640 acres*
	= 2.589988110336 square kilometers*
1 square centimeter .....	= 0.15500031 square inch
	= 0.00107639 square foot
1 square meter .....	= 10.76391045 square feet
	= 1.19599005 square yards
1 square kilometer .....	= 247.1053815 acres
	= 0.38610216 square statute mile
	= 0.29155335 square nautical mile

**Astronomy**

1 mean solar unit .....	= 1.00273791 sidereal units
1 sidereal unit .....	= 0.99726957 mean solar unit
1 microsecond .....	= 0.000001 second*
1 second .....	= 1,000,000 microseconds*
	= 0.01666667 minute
	= 0.00027778 hour
	= 0.00001157 day
1 minute .....	= 60 seconds*
	= 0.01666667 hour
	= 0.00069444 day
1 hour .....	= 3,600 seconds*
	= 60 minutes*
	= 0.04166667 day
1 mean solar day .....	= 24 <sup>h</sup> 03 <sup>m</sup> 56 <sup>s</sup> 55536 of mean sidereal time
	= 1 rotation of earth with respect to sun (mean)*
	= 1.00273791 rotations of earth with respect to vernal equinox (mean)
	= 1.0027378118868 rotations of earth with respect to stars (mean)
1 mean sidereal day .....	= 23 <sup>h</sup> 56 <sup>m</sup> 04 <sup>s</sup> 09054 of mean solar time
1 sidereal month .....	= 27.321661 days
	= 27 <sup>d</sup> 07 <sup>h</sup> 43 <sup>m</sup> 11 <sup>s</sup> 5
1 synodical month .....	= 29.530588 days
	= 29 <sup>d</sup> 12 <sup>h</sup> 44 <sup>m</sup> 02 <sup>s</sup> 8
1 tropical (ordinary) year .....	= 31,556,925.975 seconds
	= 525,948.766 minutes
	= 8,765.8128 hours
	= 365 <sup>d</sup> 24219879–0 <sup>d</sup> 0000000614( <i>t</i> –1900), where <i>t</i> = the year (date)
	= 365 <sup>d</sup> 05 <sup>h</sup> 48 <sup>m</sup> 46 <sup>s</sup>
1 sidereal year .....	= 365 <sup>d</sup> 25636042+0.0000000011( <i>t</i> –1900), where <i>t</i> = the year (date)
	= 365 <sup>d</sup> 06 <sup>h</sup> 09 <sup>m</sup> 09 <sup>s</sup> 5



## Earth

Acceleration due to gravity (standard)	= 980.665 centimeters per second per second = 32.1740 feet per second per second
Mass	= 5,980,000,000,000,000,000,000,000,000 grams = 6,600,000,000,000,000,000,000 short tons = 5,900,000,000,000,000,000,000 long tons
Mean density	= 5.517 grams per cubic centimeter
Velocity of escape	= 6.94 statute miles per second
Curvature of surface	= 0.8 foot per nautical mile
<i>Clarke spheroid of 1886</i>	
Equatorial radius ( <i>a</i> )	= 20,925,874.05 feet = 6,975,291.35 yards = 6,378,206.4 meters = 3,963.234 statute miles = 3,443.957 nautical miles
Polar radius ( <i>b</i> )	= 20,854,933.76 feet = 6,951,644.59 yards = 6,356,583.8 meters = 3,949.798 statute miles = 3,432.282 nautical miles
Mean radius $\left(\frac{2a+b}{3}\right)$	= 20,902,227.28 feet = 6,967,409.09 yards = 6,370,998.9 meters = 3,958.755 statute miles = 3,440.065 nautical miles
1' of equator	= 6,087.090 feet = 2,029.030 yards = 1,855.345 meters = 1.153 statute miles = 1.002 nautical miles
1' of latitude at equator	= 6,045.889 feet = 2,015.296 yards = 1,842.787 meters = 1.145 statute miles = 0.995 nautical mile
1' of latitude at pole	= 6,107.795 feet = 2,035.932 yards = 1,2861.656 meters = 1.157 statute miles = 1.005 nautical miles
Flattening or ellipticity $\left(f = \frac{a-b}{a}\right)$	= $\frac{1}{294.98}$ = 0.00339007530
Eccentricity ( $e = \sqrt{2f - f^2}$ )	= 0.08227185422
Eccentricity squared ( $e^2$ )	= 0.006768865800
<i>Clarke spheroid of 1880</i>	
Equatorial radius ( <i>a</i> )	= 20,926,014.29 feet = 6,975,338.10 yards = 6,378,249.145 meters = 3,963.260 statute miles = 3,443.980 nautical miles
Polar radius ( <i>b</i> )	= 20,854,707.61 feet = 6,951,569.20 yards = 6,356,514.870 meters = 3,949.755 statute miles = 3,432,245 nautical miles
Mean radius $\left(\frac{2a+b}{3}\right)$	= 20,902,245.39 feet = 6,967,415.13 yards = 6,371,004.387 meters = 3,958.759 statute miles = 3,440.068 nautical miles

1' of equator .....	= 6,087.129 feet
	= 2,029.043 yards
	= 1,855.357 meters
	= 1.153 statute miles
	= 1.002 nautical miles
1' of latitude at equator .....	= 6,045.719 feet
	= 2,015.240 yards
	= 1,842.735 meters
	= 1.145 statute miles
	= 0.995 nautical mile
1' of latitude at pole .....	= 6,107.943 feet
	= 2,035.981 yards
	= 1,861.701 meters
	= 1.157 statute miles
	= 1.005 nautical miles
Flattening or ellipticity $(f = \frac{a-b}{a})$ .....	= $\frac{1}{293.465}$
Eccentricity $(e = \sqrt{2f-f^2})$ .....	= 0.00340756138
Eccentricity squared $(e^2)$ .....	= 0.00680351112

*International spheroid*

Equatorial radius (a) .....	= 20,926,469.85 feet
	= 6,975,489.95 yards
	= 6,378,388 meters
	= 3,963.347 statute miles
	= 3,444.055 nautical miles
Polar radius (b) .....	= 20,854,707.61 feet
	= 6,951,569.20 yards
	= 6,356,514.870 meters
	= 3,949.755 statute miles
	= 3,432,245 nautical miles
Mean radius $(\frac{2a+b}{3})$ .....	= 20,902,983.35 feet
	= 6,967,661.12 yards
	= 6,371,229.315 meters
	= 3,958.898 statute miles
	= 3,440.190 nautical miles
1' of equator .....	= 6,087.264 feet
	= 2,029.088 yards
	= 1,855.398 meters
	= 1.153 statute miles
	= 1.002 nautical miles
1' of latitude at equator .....	= 6,046.342 feet
	= 2,015.447 yards
	= 1,842.925 meters
	= 1.145 statute miles
	= 0.995 nautical miles
1' of latitude at pole .....	= 6,107.828 feet
	= 2,035.943 yards
	= 1,861.666 meters
	= 1.157 statute miles
	= 1.005 nautical miles
Flattening or ellipticity $(f = \frac{a-Bb}{a})$ .....	= $\frac{1}{297}$
Eccentricity $(e = \sqrt{2f-f^2})$ .....	= 0.00336700337
Eccentricity squared $(e^2)$ .....	= 0.08199188997
	= 0.00672267002

**Energy**

1 joule .....	= 0.10197 kilogram-meters
	= 0.7376 foot-pounds
	= $2.778 \times 10^{-7}$ kilowatt hours
	= $3.725 \times 10^{-7}$ horsepower hours

	= 2.388 × 10 <sup>-4</sup> kilocalories
	= 9.478 × 10 <sup>-4</sup> B.T.U.
1 kilogram-meter .....	= 9.8067 joules
	= 7.233 foot-pounds
	= 2.724 × 10 <sup>-6</sup> kilowatt hours
	= 3.653 × 10 <sup>-6</sup> horsepower hours
	= 2.342 × 10 <sup>-3</sup> kilocalories
	= 9.295 × 10 <sup>-3</sup> B.T.U.
1 foot-pound .....	= 1.356 joules
	= 0.1383 kilogram-meters
	= 3.766 × 10 <sup>-7</sup> kilowatt hours
	= 5.051 × 10 <sup>-7</sup> horsepower hours
	= 3.238 × 10 <sup>-4</sup> kilocalories
	= 1.285 × 10 <sup>-3</sup> B.T.U.
1 kilowatt hour .....	= 3.6 × 10 <sup>6</sup> joules
	= 3.671 × 10 <sup>5</sup> kilogram-meters
	= 2.655 × 10 <sup>6</sup> foot-pounds
	= 1.341 horsepower hours
	= 859.9 kilocalories
	= 3,412 B.T.U.
1 horsepower hour .....	= 2.685 × 10 <sup>6</sup> joules
	= 2.738 × 10 <sup>5</sup> kilogram-meters
	= 1.98 × 10 <sup>6</sup> foot-pounds
	= 0.7457 kilowatt hours
	= 641.2 kilocalories
	= 2,544 B.T.U.
1 kilocalories .....	= 4,187 joules
	= 426.9 kilogram-meters
	= 3,088 foot-pounds
	= 1.163 × 10 <sup>-3</sup> kilowatt hours
	= 1.560 × 10 <sup>-3</sup> horsepower hours
	= 3.968 B.T.U.
1 B.T.U. ....	= 1.055 joules
	= 107.6 kilogram-meters
	= 778.2 foot-pounds
	= 2.931 × 10 <sup>-4</sup> kilowatt hours
	= 3.93 × 10 <sup>-4</sup> horsepower hours
	= 0.25200 kilocalories

**Length**

1 inch .....	= 25.4 millimeters*
	= 2.54 centimeters*
1 foot (U.S.) .....	= 12 inches*
	= 1 British foot
	= 1/3 yard*
	= 0.3048 meter*
	= 1/6 fathom*
1 foot (U.S. Survey) .....	= 0.30480061 meter
1 yard .....	= 36 inches*
	= 3 feet*
	= 0.9144 meter*
1 fathom .....	= 6 feet*
	= 2 yards*
	= 1.8288 meters*
1 cable .....	= 720 feet*
	= 240 yards*
	= 219.4560 meters*
1 cable (British) .....	= 0.1 nautical mile
1 statute mile .....	= 5,280 feet*
	= 1,760 yards*
	= 1,609.344 meters*
	= 1.609344 kilometers*
	= 0.86897624 nautical mile
1 nautical mile .....	= 6,076.11548556 feet
	= 2,025.37182852 yards

	= 1.852 meters*
	= 1.852 kilometers*
	= 1.150779448 statute miles
1 meter .....	= 100 centimeters*
	= 39.370079 inches
	= 3.28083990 feet
	= 1.09361330 yards
	= 0.54680665 fathom
	= 0.00062137 statute mile
	= 0.00053996 nautical mile
1 kilometer .....	= 3,280.83990 feet
	= 1,093.61330 yards
	= 1,000 meters*
	= 0.62137119 statute mile
	= 0.53995680 nautical mile

### Mass

1 ounce .....	= 437.5 grains*
	= 28.349523125 grams*
	= 0.0625 pound*
	= 0.028349523125 kilogram*
1 pound .....	= 7,000 grains*
	= 16 ounces*
	= 0.45359237 kilogram*
1 short ton .....	= 2,000 pounds*
	= 907.18474 kilograms*
	= 0.90718474 metric ton*
	= 0.89285714 long ton
1 long ton .....	= 2,240 pounds*
	= 1,016.0469088 kilograms*
	= 1.12 short tons*
	= 1.0160469088 metric tons*
1 kilogram .....	= 2.204622622 pounds
	= 0.00110231 short ton
	= 0.00098421 long ton
1 metric ton .....	= 2,204.6226218 pounds
	= 1,000 kilograms*
	= 1.10231131 short tons
	= 0.98420653 long ton

### Mathematics

$\pi$ .....	= 3.1415926535897932384626433832795028841971
$\pi^2$ .....	= 9.8696044011
$\sqrt{\pi}$ .....	= 1.7724538509
Base of Napierian logarithms (e) .....	= 2.718281828459
Modulus of common logarithms ( $\log_{10}e$ ) .....	= 0.4342944819032518
1 radian .....	= 206,264."80625
	= 3,437'.7467707849
	= 57. <sup>o</sup> 2957795131
	= 57. <sup>o</sup> 17'44."80625
1 circle .....	= 1,296,000"*
	= 21,600'*
	= 360 <sup>o</sup> *
	= 2 $\pi$ radians*
180 <sup>o</sup> .....	= $\pi$ radians*
1 <sup>o</sup> .....	= 3600"*
	= 60'*
	= 0.0174532925199432957666 radian
1' .....	= 60"*
	= 0.000290888208665721596 radian
1" .....	= 0.000004848136811095359933 radian
Sine of 1' .....	= 0.00029088820456342460
Sine of 1" .....	= 0.00000484813681107637

## Meteorology

### Atmosphere (dry air)

Nitrogen .....	= 78.08%	} 99.99%
Oxygen .....	= 20.95%	
Argon .....	= 0.93%	
Carbon dioxide .....	= 0.03%	
Neon .....	= 0.0018%	
Helium .....	= 0.000524%	
Krypton .....	= 0.0001%	
Hydrogen .....	= 0.00005%	
Xenon .....	= 0.0000087%	
Ozone .....	= 0 to 0.000007% (increasing with altitude)	
Radon .....	= .000000000000000006% (decreasing with altitude)	

Standard atmospheric pressure at sea level .....	= 1,013,250 dynes per square centimeter*
	= 1,033.227 grams per square centimeter*
	= 1,033.227 centimeters of water
	= 1,013.250 millibars*
	= 760 millimeters of mercury
	= 76 centimeters of mercury
	= 33.8985 feet of water
	= 29.92126 inches of mercury
	= 14.6960 pounds per square inch
	= 1.033227 kilograms per square centimeter
	= 1.013250 bars*
Absolute zero .....	= (-) 273° 15 C
	= (-) 459° 67 F

## Pressure

1 dyne per square centimeter .....	= 0.001 millibar*
	= 0.000001 bar*
1 gram per square centimeter .....	= 1 centimeter of water
	= 0.980665 millibar*
	= 0.07355592 centimeter of mercury
	= 0.0289590 inch of mercury
	= 0.0142233 pound per square inch
	= 0.001 kilogram per square centimeter*
	= 0.000967841 atmosphere
1 millibar .....	= 1,000 dynes per square centimeter*
	= 1.01971621 grams per square centimeter
	= 0.07500617 millimeter of mercury
	= 0.03345526 foot of water
	= 0.02952998 inch of mercury
	= 0.01450377 pound per square inch
	= 0.001 bar*
	= 0.00098692 atmosphere
1 millimeter of mercury .....	= 1.35951 grams per square centimeter
	= 1.3332237 millibars
	= 0.1 centimeter of mercury*
	= 0.04460334 foot of water
	= 0.39370079 inch of mercury
	= 0.01933677 pound per square inch
	= 0.001315790 atmosphere
1 centimeter of mercury .....	= 10 millimeters of mercury*
1 inch of mercury .....	= 34.53155 grams per square centimeter
	= 33.86389 millibars
	= 25.4 millimeters of mercury*
	= 1.132925 feet of water
	= 0.4911541 pound per square inch
	= 0.03342106 atmosphere
1 centimeter of water .....	= 1 gram per square centimeter
	= 0.001 kilogram per square centimeter

1 foot of water	= 30.48000 grams per square centimeter = 29.89067 millibars = 2.241985 centimeters of mercury = 0.882671 inch of mercury = 0.4335275 pound per square inch = 0.02949980 atmosphere
1 pound per square inch	= 68,947.57 dynes per square centimeter = 70.30696 grams per square centimeter = 70.30696 centimeters of water = 68.94757 millibars = 51.71493 millimeters of mercury = 5.171493 centimeters of mercury = 2.306659 feet of water = 2.036021 inches of mercury = 0.07030696 kilogram per square centimeter = 0.06894757 bar = 0.06804596 atmosphere
1 kilogram per square centimeter	= 1,000 grams per square centimeter* = 1,000 centimeters of water
1 bar	= 1,000,000 dynes per square centimeter* = 1,000 millibars*

### Speed

1 foot per minute	= 0.01666667 foot per second = 0.00508 meter per second*
1 yard per minute	= 3 feet per minute* = 0.05 foot per second* = 0.03409091 statute mile per hour = 0.02962419 knot = 0.01524 meter per second*
1 foot per second	= 60 feet per minute* = 20 yards per minute* = 1.09728 kilometers per hour* = 0.68181818 statute mile per hour = 0.59248380 knot = 0.3048 meter per second*
1 statute mile per hour	= 88 feet per minute* = 29.33333333 yards per minute = 1.609344 kilometers per hour* = 1.46666667 feet per second = 0.86897624 knot = 0.44704 meter per second*
1 knot	= 101.26859143 feet per minute = 33.75619714 yards per minute = 1.852 kilometers per hour* = 1.85447652 feet per second = 1.15077945 statute miles per hour = 0.51444444 meter per second
1 kilometer per hour	= 0.62137119 statute mile per hour = 0.53995680 knot
1 meter per second	= 196.85039340 feet per minute = 65.6167978 yards per minute = 3.6 kilometers per hour* = 3.28083990 feet per second = 2.23693632 statute miles per hour = 1.94384449 knots
Light in vacuo	= 299,792 kilometers per second = 186,282 statute miles per second = 161,875 nautical miles per second = 983.570 feet per microsecond
Light in air	= 299,708 kilometers per second = 186,230 statute miles per second



	= 161,829 nautical miles per second
	= 983.294 feet per microsecond
Sound in dry air at 60° F and standard sea level pressure .....	= 1,116.99 feet per second
	= 761.59 statute miles per hour
	= 661.80 knots
	= 340.46 meters per second
Sound in 3.485 percent salt water at 60° F .....	= 4,945.37 feet per second
	= 3,371.85 statute miles per hour
	= 2,930.05 knots
	= 1,507.35 meters per second

**Volume**

1 cubic inch .....	= 16.387064 cubic centimeters*
	= 0.01638661 liter
	= 0.00432900 gallon
1 cubic foot .....	= 1,728 cubic inches*
	= 28.31605503 liters
	= 7.48051946 U.S. gallons
	= 6.22883522 imperial (British) gallons
	= 0.028316846592 cubic meter*
1 cubic yard .....	= 46,656 cubic inches*
	= 764.53367616 liters
	= 201.974010624 U.S. gallons
	= 168.17859283 imperial (British) gallons
	= 27 cubic feet*
	= 0.764554857984 cubic meter*
1 cubic centimeter .....	= 0.06102374 cubic inch
	= 0.00026417 U.S. gallon
	= 0.00021997 imperial (British) gallon
1 cubic meter .....	= 264.17203187 U.S. gallons
	= 219.96923879 imperial (British) gallons
	= 35.31466655 cubic feet
	= 1.30795059 cubic yards
1 quart (U.S.) .....	= 57.75 cubic inches*
	= 32 fluid ounces*
	= 2 pints*
	= 0.94632645 liter
	= 0.25 gallon*
1 gallon (U.S.) .....	= 3,785.3984784 cubic centimeters*
	= 231 cubic inches*
	= 0.13368056 cubic foot
	= 4 quarts*
	= 3.7853058 liters
	= 0.83267412 imperial (British) gallon
1 liter .....	= 1,000.028 cubic centimeters
	= 61.02545 cubic inches
	= 1.05671780 quarts
	= 0.26417945 gallon
1 register ton .....	= 100 cubic feet*
	= 2.8316846592 cubic meters*
1 measurement ton .....	= 40 cubic feet*
	= 1 freight ton*
1 freight ton .....	= 40 cubic feet*
	= 1 measurement ton*

**Volume-mass**

1 cubic foot of sea water	.....	= 64 pounds
1 cubic foot of fresh water	.....	= 62.428 pounds at temperature of maximum density (4° C = 39°2 F)
1 cubic foot of ice	.....	= 56 pounds
1 displacement ton	.....	= 35 cubic feet of sea water * = 1 long ton

(1) Taken in part from Bowditch (H.O. Pub. and the U.S. Navy Diving Manual, NAVSHIPS 0994-001-9010)

(2) All values in this appendix are based on the following relationships:

- 1 inch = 2.54 centimeters\*
- 1 yard = 0.9144 meter \*
- 1 pound (avoirdupois) = 0.45359237 kilogram \*
- 1 nautical mile = 1852 meters\*
- Absolute zero = (-)273°15 C = (-)459°67 F.

**COMMONLY USED FORMULAS**

**Symbols and Notes**

A	Area
C	Circumference
D	Depth of water
H	Height
L	Length
N	Number of divers
R	Radius
T	Tons
V	Volume
Dia.	Diameter
Dia. <sup>2</sup>	Diameter squared
Dia. <sup>3</sup>	Diameter cubed
π (pi)	3.1416
1/4 π	.7854
1/6 π	.5236
P.P.	Partial Pressure
psi	Pressure per square inch
psig	Gage Pressure
psia	Absolute pressure
F.P.M.	Feet per minute
B.S.	Breaking strain of line or rope
S.W.	Safe working load of line or rope

**Lifting Capacity (in Pounds)**

Fresh water (V X 62.4) = Weight of lifting unit  
Salt water (V X 64) = Weight of lifting unit

**Miscellaneous Formulas**

Partial Pressure of a gas (in psi) –  
P.P. = [(D + 33) X .455] X % of gas

$$P.P. = \left[ \frac{D + 33}{33} \right] \times \% \text{ of gas, in ata.}$$

P.P. = [D + 33] X % of gas, in fsw.

Time between stops in seconds –

$$T = \frac{(D_{left} - D_{arrived}) \times 60}{F.P.M.}$$

**Formula for Areas**

The area of a square or rectangle –

$$A = L \times W$$

The area of a circle –

$$A = .7854 \times \text{Dia.}^2 \text{ or } A = \pi R^2$$

Emergency Hose Test [(D X .445) + 50] X 2  
(Hold pressure for 10 minutes)

### Formulas for Volumes

The volume of a cube (compartment) —

$$V = L \times W \times H$$

The volume of a sphere (balloon) —

$$V = .5236 \times \text{Dia.}^3$$

The volume of a cylinder (pontoon) —

$$V = .7854 \times \text{Dia.}^2 \times L$$

### Temperature Conversions

1. Fahrenheit to Centigrade

$$^{\circ}\text{C} = 5/9 (^{\circ}\text{F} - 32)$$

2. Centigrade to Fahrenheit

$$^{\circ}\text{F} = 9/5 (^{\circ}\text{C}) + 32)$$

### Formulas for Seamanship

1. Breaking strain of natural fiber line =

$$C^2 \times 900 \text{ lbs.}$$

2. Breaking strain of nylon wire =  $C^2 \times 2,400 \text{ lbs.}$

3. Breaking strain of wire =  $C^2 \times 8,000 \text{ lbs.}$

Safe working load for 1-2-3 above —

$$1/4 \text{ B.S.} = \text{S.W. for new line or wire}$$

$$1/6 \text{ B.S.} = \text{S.W. for average line or wire}$$

$$1/8 \text{ B.S.} = \text{S.W. for unfavorable conditions}$$

Safe working load of a shackle =

$$3 \times \text{Dia.}^2 = \text{S.W. in tons}$$

Safe working load of a hook =

$$2/3 \times \text{Dia.}^2 = \text{S.W. in tons}$$

93<sup>d</sup> CONGRESS  
1<sup>st</sup> SESSION**H. R. 8924**

## IN THE HOUSE OF REPRESENTATIVES

JUNE 22, 1973

Mr. DOWNING (for himself, Mrs. SULLIVAN, Mr. MOSHER, Mr. ROGERS, and Mr. MURPHY of New York) introduced the following bill; which was referred to the Committee on Merchant Marine and Fisheries

**A BILL**

To promote safety in the operation of submersible vessels.

1       *Be it enacted by the Senate and House of Representa-*  
2       *tives of the United States of America in Congress assembled,*  
3       That this Act may be cited as the "Submersible Vessel  
4       Safety Act".

5       SEC. 2. As used in this Act—

6             (1) "Secretary" means the Secretary of the de-  
7       partment in which the Coast Guard is operating, and

8             (2) "submersible vessel" includes any contrivance  
9       used or designed for transportation underwater, for  
10      human occupancy underwater, or for underwater com-  
11      mercial purposes, other than those of the Government

I

1 of the United States used or designed as instruments  
2 of war.

3 SEC. 3. (a) To promote safety in the operation of sub-  
4 mersible vessels, the Secretary may prescribe regulations—

5 (1) for the design, materials, workmanship, con-  
6 struction, outfitting, performance, maintenance, and  
7 alteration of submersible vessels;

8 (2) for the design, materials, workmanship, con-  
9 struction, performance, maintenance, and alteration of  
10 equipment incidental to the operation of submersible  
11 vessels;

12 (3) for tests and examinations with respect to  
13 paragraphs (1) and (2) of this subsection including  
14 provisions for their performance by qualified private  
15 persons whose tests, examinations, and reports are ac-  
16 ceptable to the Secretary;

17 (4) for the manning of submersible vessels, includ-  
18 ing the duties and qualifications of operating personnel;  
19 and

20 (5) for such other practices and procedures as the  
21 Secretary finds necessary to provide adequately for  
22 safety.

23 (b) When the Secretary finds it in the public interest  
24 he may grant exemptions from the requirements of any  
25 regulation prescribed under this section.

1 (c) Submersibles certified by the American Bureau of  
2 Shipping or other classification society approved by the Sec-  
3 retary may be accepted as having met sections 3 (a) (1)  
4 and (2).

5 (d) The Secretary may by regulation exempt manned  
6 submersible vessels from the requirements of this Act and  
7 any regulation issued thereunder if he determines that the  
8 manned submersible vessel is being constructed or operated  
9 for developmental, experimental or research work.

10 SEC. 4. (a) The Secretary may group submersible  
11 vessels into classes on the basis of similarity of characteristics  
12 or of utilization, or both.

13 (b) The owner or the builder of a submersible vessel  
14 subject to any regulation issued under section 3 of this Act  
15 shall apply to the Secretary for a certificate of inspection.  
16 If the Secretary finds, after inspection, that the submersible  
17 vessel is properly equipped and safe to be operated in accord-  
18 ance with the requirements of this Act and the regulations  
19 hereunder, he shall issue a certificate of inspection. The Sec-  
20 retary may prescribe in a certificate of inspection the dura-  
21 tion thereof and such other terms, conditions, and limita-  
22 tions as are required in the interest of safety.

23 (c) The Secretary may, from time to time as he deems  
24 necessary, reinspect any submersible vessel for which a  
25 certificate of inspection has been issued. If the Secretary

1 determines as a result of a reinspection that such submersible  
2 vessel is in violation of this Act or any regulation issued  
3 under this Act, and that it is in the interest of safety, he  
4 may amend, suspend, or revoke a certificate of inspection.

5       SEC. 5. (a) The Secretary may issue submersible vessel  
6 operators licenses in accordance with regulations prescribed  
7 by him, to applicants found qualified as to age, character,  
8 habits of life, experience, professional qualifications, and  
9 physical and mental fitness.

10       (b) The Secretary may prescribe with respect to any  
11 license issued such terms, conditions, limitations as to dura-  
12 tion thereof, periodic or special examinations, tests of physical  
13 fitness, and other matters as he determines necessary to as-  
14 sure safety in the operation of submersible vessels.

15       (c) The Secretary may suspend or revoke a license  
16 issued under this section if the holder—

17           (1) has violated any law or regulation intended to  
18 promote marine safety or protect navigable waters,

19           (2) is physically, mentally, or professionally incom-  
20 petent, or

21           (3) has committed an act of misconduct or negli-  
22 gence while operating such a vessel.

23       (d) No person shall operate any submersible vessel with-  
24 out an operator's license if by regulations established under  
25 this section he is required to have a valid submersible vessel

1 operator's license for such operation. Whoever violates this  
2 subsection shall be liable to a civil penalty of \$1,000 to  
3 be assessed by the Secretary. The Secretary may remit or  
4 mitigate upon such terms as he deems proper any penalty  
5 assessed under this section.

6       SEC. 6. (a) The Secretary may examine, evaluate, and  
7 rate civilian schools giving instruction in the operation of  
8 submersible vessels. When the Secretary is satisfied as to  
9 the adequacy of a school's course of instruction, the suit-  
10 ability and seaworthiness of its equipment, and the com-  
11 petency of its instructors, he may issue a certificate for the  
12 school.

13       (b) If the Secretary finds as a result of a reexamination  
14 or reevaluation that it is in the interest of safety, he may  
15 modify, suspend, or revoke a school's certificate.

16       SEC. 7. (a) The Secretary may appoint, without regard  
17 to the provisions of title 5, United States Code, governing  
18 appointments in the competitive service, advisory commit-  
19 tees for the purpose of consultation with and advice in the  
20 performance of functions under this Act.

21       (b) Members of such committees, other than those reg-  
22 ularly employed by the Federal Government, while attend-  
23 ing committee meetings or otherwise in the performance of  
24 their duties under this Act, may be paid compensation at  
25 rates not exceeding \$100 per day and, while serving away



1 from their homes or regular places of business, may be al-  
2 lowed travel expenses, including per diem in lieu of sub-  
3 sistence, as authorized by section 5703 of title 5, United  
4 States Code, for persons employed intermittently in the  
5 Government service.

6       SEC. 8. (a) The owner and the person in charge of a  
7 submersible vessel found in violation of this Act or the regu-  
8 lations issued under this Act, are each liable to a civil penalty  
9 of \$1,000 for each such violation to be assessed by the  
10 Secretary.

11       (b) A submersible vessel found in violation of this Act  
12 or the regulations issued under this Act is liable to a civil  
13 penalty of \$1,000 to be assessed by the Secretary for which  
14 the vessel may be libeled and proceeded against in any dis-  
15 trict court of the United States having jurisdiction.

16       (c) The Secretary may remit or mitigate upon such  
17 terms as he deems proper any penalty assessed under this  
18 section.

19       SEC. 9. Nothing in this Act shall be construed to impair  
20 or affect any authority of the Atomic Energy Commission  
21 under the Atomic Energy Act of 1954, as amended.

22       SEC. 10. The Secretary shall, upon the request of the  
23 Secretary of Defense, exempt from the requirements of this  
24 Act or any regulation issued under this Act such submersible  
25 vessels as may be requested by the Secretary of Defense.

APPENDIX III  
SEA OTTER  
Pre Dive Check List  
(To be completed for the first dive of the day)

Dive \_\_\_\_\_

Date \_\_\_\_\_

**General**

- \_\_\_\_\_ 1. All discrepancies cleared and/or noted from previous dive.
- \_\_\_\_\_ 2. Compensation system filled, minimum 2000' PSI.
- \_\_\_\_\_ 3. Air ballast system filled, minimum 2000' PSI.
- \_\_\_\_\_ 4. O<sub>2</sub> – 3 full bottles plus 4th in use (40 man hours per bottle).
- \_\_\_\_\_ 5. LiOH – 2 full cannisters plus 3rd in use (64 man hours per bottle).
- \_\_\_\_\_ 6. Weight and ballast completed.

**External**

- \_\_\_\_\_ 1. Equipment on brow secure, penetrators and compensating lines secure.
- \_\_\_\_\_ 2. Ballast weight secure.
- \_\_\_\_\_ 3. Drop weight secure.
- \_\_\_\_\_ 4. Thrusters clear.
- \_\_\_\_\_ 5. Main propulsion clear.
- \_\_\_\_\_ 6. No obvious structural damage.
- \_\_\_\_\_ 7. Air systems filling valves capped.
- \_\_\_\_\_ 8. Antenna and transducers clear.
- \_\_\_\_\_ 9. Flag secured to antenna.
- \_\_\_\_\_ 10. Marker buoy secure and spool line secure.
- \_\_\_\_\_ 11. Hatch "O" ring cleared, and inspected and greased.
- \_\_\_\_\_ 12. Magnetic compass.
- \_\_\_\_\_ 13. Compensating valve open.
- \_\_\_\_\_ 14. Lifting bridle.

**Cabin Checks**

- |                                                      |                                        |
|------------------------------------------------------|----------------------------------------|
| _____ 1. Valves set for dives<br>dump valves closed. | _____ 8. Sonar – spare parts.          |
| _____ 2. Drop weight free and<br>handle aboard.      | _____ 9. Video – spare tapes.          |
| _____ 3. Surface radio.                              | _____ 10. Tape Recorder – spare tapes. |
| _____ 4. V/W phone and pinger.                       | _____ 11. Scrubber – both models.      |
| _____ 5. Thrusters.                                  | _____ 12. Gyro.                        |
| _____ 6. Main propulsion.                            | _____ 13. Manipulator.                 |
| _____ 7. External lights, dome and<br>panel lights.  | _____ 14. Camera and strobe.           |
|                                                      | _____ 15. All mechanical penetrators.  |

**Emergency Equipment**

- \_\_\_\_\_ 1. Lights (2)
- \_\_\_\_\_ 2. Water and food
- \_\_\_\_\_ 3. Inflatable life preservers (3)
- \_\_\_\_\_ 4. Face masks (3)
- \_\_\_\_\_ 5. Xenon flasher and mirror
- \_\_\_\_\_ 6. Relief bottle
- \_\_\_\_\_ 7. Tool kit, fuses
- \_\_\_\_\_ 8. Emergency breathing
- \_\_\_\_\_ 9. O<sub>2</sub> and CO<sub>2</sub> gas sensing devices
- \_\_\_\_\_ 10. Compensating system emergency filler hose
- \_\_\_\_\_ 11. O<sub>2</sub> wrenches (2)
- \_\_\_\_\_ 12. Spare Scrubber motor

**Misc. Equipment**

- \_\_\_\_\_ 1. 35 mm camera, spare film
- \_\_\_\_\_ 2. Dive logs and pens
- \_\_\_\_\_ 3. Customer equipment
- \_\_\_\_\_ 4. Proper clothing for all aboard
- \_\_\_\_\_ 5. All surface support equipment checked and operational
- \_\_\_\_\_ 6. If 3 men aboard add 1 O<sub>2</sub> bottle and 1 LiOH cannister.

Signed \_\_\_\_\_  
Crew Chief

Signed \_\_\_\_\_  
Pilot

**SEA OTTER  
Post Dive Check Sheet**

**Mech.**

- \_\_\_\_\_ Variable ballast drained and flushed.
- \_\_\_\_\_ Compensation system checked for water.
- \_\_\_\_\_ Check motor drain plug.
- \_\_\_\_\_ Sub hosed down.
- \_\_\_\_\_ \_\_\_\_\_
- \_\_\_\_\_ \_\_\_\_\_

**Electrical**

- \_\_\_\_\_ Spare fuses checked and replenished.
- \_\_\_\_\_ Aux. batteries checked and replaced as necessary.
- \_\_\_\_\_ Time commenced battery charge.
- \_\_\_\_\_ Gyro caged.
- \_\_\_\_\_ \_\_\_\_\_
- \_\_\_\_\_ \_\_\_\_\_

**Life Support**

- \_\_\_\_\_ Emergency equipment inspected and completed.
- \_\_\_\_\_ Interior cleaned and relief bottles removed.
- \_\_\_\_\_ Hatch sprayed, "O" ring cleaned and stored.
- \_\_\_\_\_ Hatch cover installed.
- \_\_\_\_\_ De-humidifier/heater installed and operating.
- \_\_\_\_\_ Empty O<sub>2</sub> cylinders removed and replaced.
- \_\_\_\_\_ Depleted CO<sub>2</sub> absorb cannisters removed and replaced.
- \_\_\_\_\_ \_\_\_\_\_
- \_\_\_\_\_ \_\_\_\_\_

APPENDIX III (Cont.)

SEA OTTER  
Weight and Balance

Sea water

Dive \_\_\_\_\_

Fresh water

Date \_\_\_\_\_

(circle one)

1.	Crew	Weights
	1.	_____
	2.	_____
	3.	_____

Total

2.	Additional Equipment	
	1.	_____
	2.	_____
	3.	_____
	4.	_____

Total

3.	Equipment Removed	
	1.	_____
	2.	_____
	3.	_____

Total

4.	SEA OTTER payload	_____
----	-------------------	-------

5.	Total of (1) and (2) minus (3)	_____
----	--------------------------------	-------

6.	Subtract 5 from 4	_____
----	-------------------	-------

7.	Amount weight added if positive Removed if negative	_____
----	--------------------------------------------------------	-------

Added  
Removed  
(circle one)

SEA OTTER 160 #s heavier in fresh water

Signed \_\_\_\_\_  
Pilot

# ACRONYMS and TERMS

A	Angstrom unit
ABS	American Bureau of Shipping
AC	Alternating current
AC	Air conditioning
AGS	Auxiliary General Survey
AIAA	American Institute of Aeronautics & Astronautics
ALCOA	Aluminum Co. of America
AM	Amplitude modulation
amp	ampere(s)
amp-hr	ampere-hour(s)
ASME	American Society of Mechanical Engineers
ASR	Auxiliary Submarine Rescue
ASTM	American Society of Testing & Materials
ATA	Atmosphere(s)
ATM	Atmosphere(s)
AUTEC	Atlantic Undersea Test & Evaluation Center
AUWE	Admiralty Underwater Weapons Establishment
AWG	American Wire Gage
B	Center of buoyancy
BALARE	Buoyancy Actuated Launch & Retrieval Elevator
BG	Submerged metacentric height
BL	Base line
Btu	British thermal unit
CB	Civilian band
CCTV	Closed Circuit Television
$C_D$	Drag coefficient
CEMA	Centre D'Etudes Marine Avancees
cfm	Cubic feet per minute
CG	Center of gravity
$C_L$	Lift coefficient
CNEXO	Centre National pour l'Exploitation des Oceans
CNM	Chief of Naval Material
CNO	Chief of Naval Operations
COF	Capagnes Oceanographique Francais
COMEX	Compagnie Maritime d'Expertises
cp	candle power
CPH	Cycles per hour
CPM	Cycles per minute
CRT	Cathode Ray Tube
CTFM	Continuous Transmission Frequency Modulated
CURV	Controlled Underwater Research Vehicle
CW	Continuous wave
D	Displacement volume
DC	Direct current
DDC	Deck decompression chamber
DDS	Deep Dive System
deg	degree
deg/sec	degrees per second
DOT	Department of Transportation

DOT	Deep Ocean Technology
DOWB	Deep Ocean Work Boat
DR	Dead reckoning
DSL	Deep scattering layer
DSRV	Deep Submergence Research Vehicle
DSRVT	Deep Submergence Research Vehicle Tender
DSSP	Deep Submergence Systems Project
DSSRG	Deep Submergence Systems Review Group
DSSV	Deep Submergence Search Vehicle
DSS	Decompression Staging System
EHP	Effective horsepower
EL	Entrance lock
EM	Electromagnetic
EMI	Electromagnetic interference
EO	Electro Oceanics
F/A	Fore/akt
FAMOUS	French-American Mid-ocean Study
fc	footcandle
FM	Frequency modulation
FNRS	Fonds National de la Recherche Scientifique
FP	Forward perpendicular
fpm	Feet per minute
ft	foot, feet
fps	feet per second
G	Center of gravity
GE	General Electric Company
gHz	Gigahertz
GP	Glass reinforced plastic
gpm	Gallons per minute
GRP	Glass reinforced plastic
GER	Groupe d'Etudes et de Recherches Sous-Marine
HERE	Human Element Range Extender
HF	High frequency
HIS	Hood Inflation System
hp	Horsepower
hr	Hour(s)
HYCO	International Hydrodynamics Ltd.
ICAD	Integrated Control & Display
ICMAREF	Combittee on Marine Research, Education & Facilities
ID	Inside diameter
IFP	Institut Francais du Petrole
in	Inch, inches
kHz	Kilohertz
KIC	Kollsman Instrument Corporation
KSI	Kilopounds per square inch
kW	kilowatt(s)
kWh	Kilowatt-hour(s)
LARP	Launch & Recovery Platform
lb	Pound(s)
LCB	Longitudinal center of buoyancy

LCG	Longitudinal center of gravity
LCT	Local Civil Time
LF	Low frequency
LLTV	Low light level TV camera
LMSC	Lockheed Missiles & Space Company
ln/m	natural log per meter
LO	Lock-out
LOA	Length overall
lpm	Liters per minute
LRT	Launch, Recovery & Transport Vehicle
M	
M	Metacenter
MARSAP	Mutual Assistance Rescue & Salvage Plan
MATLAB	U.S. Navy Materials Laboratory
MBT	Main ballast tank
MF	Medium frequency
Mhos/m	Milliohms per meter
mHz	Megahertz
MILSPECS	Military Specifications
MSO	Minesweeper, Ocean
MTS	Marine Technology Society
MUA	Manned Undersea Activities
MUST	Manned Undersea Science & Technology
M/V	Motor Vessel
NA	
NA	Not available
NASA	National Aeronautics & Space Administration
NAVMAT	Navy Material Command
NAVOCEANO	Naval Oceanographic Office
NAVSEC	Secretary of the Navy
NAVSHIPS	Naval Ship Systems Command
NCEL	Naval Civil Engineering Laboratory
NEL	Navy Electronics Laboratory
NOAA	National Oceanic & Atmospheric Administration
NODC	National Oceanographic Data Center
NP	No provisions (aboard)
NRL	Naval Research Laboratory
NSRDC	Naval Ship Research & Development Center
NSRDL	Naval Ship Research & Development Laboratory
NTP	Normal Temperature & Pressure
NUC	Naval Undersea Center
NURDC	Naval Undersea Research & Development Center
OBA	
OBA	Oxygen Breathing Apparatus
OD	Outside diameter
OFRS	Office Francais de Recherches Sous-Marine
OPNAVINST	Chief of Naval Operations Instruction
ORE	Ocean Research Equipment, Inc.
OSC	On-scene commander
P	
P	Pulse
pcf	Pounds per cubic foot
PCT	Primary cable termination
Ph	Phase comparison
PHA	Working manipulator

PPI	Pilot presentation indicator
ppm	Parts per million
ppt	Parts per thousand
P/S	Port/Starboard
psf	Pounds per square foot
psi	Pounds per square inch
psia	Pounds per square inch absolute
psig	Pounds per square inch gage
PTC	Personnel Transfer Capsule
PVC	Polyvinyl chloride
R&D	Research & Development
RCC	Rescue Control Center
RFP's	Request for proposals
RH	Relative humidity
rms	Root mean square
rpm	Revolutions per minute
RQ	Respiratory Quotient
R/V	Research Vessel
SAR	Search & Rescue
SCA	System Classification Authority
SCF	Standard cubic foot
SCFH	Standard cubic foot per hour
SCFM	Standard cubic foot per minute
SHP	Shaft horsepower
SIT	Silicon Intensifier Target
SNAME	Society of Naval Architects & Marine Engineers
SOO	Ship of Opportunity
SPCC	Strength, power, communication cable
SRC	Submarine Rescue Chamber
SSB	Single side band
STAR	Submarine Test & Research Vehicle
STP	Standard Temperature & Pressure
SUBDEV-	
GRU-1	Submarine Development Group One
SUPSAL	Supervisor of Salvage
TIP	Transponder Interrogation System
TPS	Tandem Propulsion System
TV	Television
UCLA	University of California-Los Angeles
UHF	Ultra high frequency
UQC	Underwater telephone
USCG	U.S. Coast Guard
USN	U.S. Navy
USNUSL	U.S. Navy Underwater Sound Laboratory
V	Volt(s)
VAC	Volts alternating current
VBT	Variable ballast tank
VCB	Verticle center of buoyancy
VCG	Vertical center of gravity
VDC	Volts direct current



VHF	Very high frequency
VLf	Very low frequency
W	Weight
WASP	Water sensor pod
WESMAR	Western Marine Electronics
Wh	Watt-hour(s)
WHOI	Woods Hole Oceanographic Institution
WWII	World War II

# CORPORATE INDEX

	Page
A. C. Electronics Div., General Motors Corp. -----	123, 546
Access Co., Ltd. -----	189
Aerojet-General Corp. -----	337
All Ocean Industries, Inc. -----	87
Allis-Chalmers -----	331
Alpine Geophysical Associates -----	502
Aluminum Company of America -----	89, 705
American Submarine Co. -----	43, 213
AMF -----	606
Anautics, Inc. -----	5, 55, 169
Arctic Marine Ltd. -----	5, 64, 169, 195
Atlantic Research Corp. -----	501
Bacharach Instrument Corp. -----	435
Ball Brothers Research Co. -----	480
Beckman Instruments, Inc. -----	544
Benthos Corp. -----	514, 550
Bio Marine Industries -----	434
Birns & Sawyer, Inc. -----	478
Bisset-Berman Corp. -----	544
Brown and Root -----	5, 230
Bruker-Physik AG -----	66, 153, 155
C&D Tools -----	225
Can Dive, Ltd. -----	5, 64, 169, 195
Capagnes Oceanographique Francais -----	208, 210
Charles Yen Submarines -----	87
Cohu Electronics Corp. -----	480
COMEX -----	82, 703
Controlex Corp. of America -----	399
Crouse-Hinds Corp. -----	350
D. G. O'Brien Co. -----	346
Deep Sea Techniques -----	84
Deep Water Exploration, Ltd. -----	217
DHB Construction, Ltd. -----	141
Dillingham Corp. -----	475
Dutch Submarine Services -----	65
Eastman Kodak Co. -----	550
Edo Western Corp. -----	480
EG&G International -----	548
Electro Oceanics Corp. -----	341, 346, 350
F. W. Dwyer Co. -----	434
Franklin Electric Co. -----	389
Garrison 8 Divers Corp. -----	107
General Applied Science Laboratory -----	509
General Dynamics Corp. -----	43, 88, 99, 193, 215, 217, 219, 331, 341, 370
General Electric Co. -----	399
General Mills Corp. -----	44, 91
General Motors Corp. -----	56
General Oceanographics, Inc. -----	55, 161, 395
General Oceans, Inc. -----	574
General Time Corp. -----	501

	Page
General Video Corp. -----	480
Giovanola Brothers -----	57, 101
Great Lakes Underwater Sports, Inc. -----	157
Grumman Aircraft Engineering Corp. -----	57, 105
Hahn & Clay -----	254
Heele Engineering, Inc. -----	43, 221, 518
Horton Maritime Explorations, Ltd. -----	64, 101, 105
Hydro-Catylator Corp. -----	324
Hydro Products -----	480, 547, 548
Ikelite Mfg. -----	478
Informatics, Inc. -----	10
International Gas Detector, Ltd. -----	434
International Hydrodynamics, Ltd. -----	52, 70, 93, 97, 183, 185, 187, 191, 345, 550
International Underwater Contractors, Inc. -----	62, 103, 173, 400, 703
ITT Cannon Electric -----	346
Japanese Steel & Tube Co. -----	149
Joy Mfg. Co. -----	346
Kawasaki Heavy Industries, Ltd. -----	66, 137, 203
Kentron, Ltd. -----	171
Katagawa Corp. -----	435
Kinautics, Inc. -----	225
Kittredge Industries -----	438
Kuofeng Ocean Development Corp. -----	66, 231
LaCoste & Romberg -----	553
Lear Siegler, Inc. -----	44, 107
Lintott Engineering, Ltd. -----	227
Lockheed Missiles & Space Co. -----	21, 113, 354
Makai Range Inc. -----	594
Marsh Marine Co. -----	346
Martine's Diving Bells, Inc. -----	40, 221, 456
Maschinenbau Gabler Gmb H -----	66, 231
Mitsubishi Heavy Industries -----	239, 275
Nautillette, Inc. -----	159
Nekton, Inc. -----	161
Nereid nv -----	65, 165
North American Rockwell Corp. -----	56, 103
Northern Offshore, Ltd. -----	179
Ocean Search Inc. -----	705
Ocean Systems, Inc. -----	56
Ocean Systems Japan, Ltd. -----	66, 137
Office Francais de Recherches Sous-Marine -----	48, 51, 60, 208
Ocean Research Equipment, Inc. (ORE) -----	550
P&O Intersubs -----	187
Pace Wianco Div., Wittaker Corp. -----	487
Pacific Submarine Co. -----	84
Perry Submarine Builders, Inc. 3, 5, 43, 70, 109, 167, 171, 173, 175, 177, 179, 181, 199, 201, 229, 237, 271, 274, 328, 333, 345	398
Phantom Motor Co. -----	167
Phillips Petroleum Co. -----	84
Pierce Submersibles, Inc. -----	333
Pratt & Whitney Corp. -----	507
R. C. Allen Co. -----	507

	Page
Reynolds International .....	88
Robb Engineering .....	85
Rohm & Haas, Inc. ....	254
Sarda Estrazione Lavorazione .....	231
Sea Graphics, Inc. ....	60, 205
Sea Line, Inc. ....	84
Sears & Roebuck, Co. ....	391
SELMAR .....	66
Sperry Rand Corp. ....	509
Straza Industries .....	469
Sub Sea Oil Services S.P.A. ....	71, 177, 189
Submarine Research and Development Corp. ....	55
Submarine Services, Inc. ....	221
Sud Aviation .....	209
Sun Shipbuilding & Drydock Co. ....	61, 135
Taylor Diving Services .....	229, 605
Technoceans, Inc. ....	99
T. H. Giff Co. ....	501
T. Thompson, Ltd. ....	196
Thompson—CSF Co. ....	481
Underwater Marine Equipment, Ltd. ....	141
Vector Cable Co. ....	341, 345
Verne Engineering .....	197
Vickers Oceanics, Ltd. ....	64, 69, 70, 183, 185, 237, 709
Viking Industries .....	346
Western Marine Electronics Corp. ....	469
Westinghouse Electric Corp. ....	44, 115, 117, 119
Weston Instrument Co. ....	501
Yomiuri Shimbu Newspaper .....	239

# SUBJECT INDEX

	Page
<b>A. B. WOOD III, RV</b> .....	706
Absolute pressure (psia), defined .....	282
Admiralty Experimental Diving Unit .....	361
Agnew, Spiro .....	59
Air weight, as a function of temperature and pressure .....	284
<b>ALBACORE</b> , hull drag coefficient .....	395
<b>ALCOA SEAPROBE</b> .....	705
All Ocean Industries submersible, described .....	87
control arrangements .....	398
Altitude sensors .....	485
<b>ALUMINAUT</b> .....	44, 63
contractors for sub-systems and components .....	281
described .....	89
examples of electrical interference on data .....	362
electrical penetrators .....	340
hull compression with depth .....	258
hull construction .....	253
control arrangements .....	402
<b>ALVIN</b> .....	44, 59
described .....	91
drag force derivation method .....	395
hull construction .....	252
pressure hull release system .....	665
salvage from 5,500 ft. .....	561
titanium electrical penetrator design .....	351
trim system .....	304
variable ballast system .....	292
viewport arrangement .....	453
viewport stress testing .....	255
Ambient light sensor .....	545
American Bureau of Shipping .....	54, 283, 288, 323, 644
classed submersibles .....	625
oxygen concentrations recommended .....	412
American Society of Mechanical Engineers .....	250
Pressure Vessel Code .....	255
<b>AMERSUB</b> .....	43
<b>APACHE, USS</b> .....	601
<b>APOLLO</b> spacecraft .....	402
Applied Research Laboratory, Univ. of Texas .....	175
<b>AQUARIUS I</b> .....	64
described .....	93
Archeological mapping .....	571
<b>ARCHIMEDE</b> .....	42
described .....	95
Archimedes principal, defined .....	16
<b>ARGONAUT</b> .....	2
<b>ARGYRONETE</b> .....	61
described .....	96
<b>ARIES</b> , described .....	97

	Page
Aristotle .....	1
<b>ASHERAH</b> , .....	48
described .....	99
electrical penetrators .....	340
isobaris altimeter system .....	486
Askania Gravity Meter .....	553
Aspect Ratio .....	377
Assoc. of American Railroads .....	578
Atlantic Undersea Test and Evaluation Center .....	49
Atmospheric contaminants, allowable concentrations .....	411
Atmospheric monitoring devices .....	430
cabin pressure .....	436
carbon dioxide .....	434
oxygen .....	430
temperature and humidity .....	435
<b>AUGUSTE PICCARD</b> .....	48
described .....	101
<b>AUTEC I &amp; II</b> .....	49, 193
Azhazha, V. G. ....	10
<b>BALARE</b> .....	60
Ballast and buoyancy methods, vehicle-by-vehicle .....	286
Ballasting Systems, irreversible .....	296
collapsible bags .....	298
gasoline .....	300
hard tanks .....	297
iron shot .....	299
pressure hulls .....	296
small weight drop .....	298
syntactic foam .....	296
Ballasting Systems, reversible .....	288
Anchoring .....	294
Ascent/descent weights .....	294
drag cables .....	296
main ballast tanks .....	288
variable ballast tanks .....	290
Barton, Otis .....	32, 38
Barnett, F. Don .....	464, 625
Barringer, John .....	497, 593
Bass, George .....	48
Bathyscaph .....	38
<b>BATHYSPHERE</b> , described .....	32-38
Internal arrangements .....	33
Batteries, advantages and disadvantages .....	319
cell characteristics of three types .....	322
characteristics of secondary types .....	320
charging .....	323
effects of pressure on capacity .....	322
effects of pressure on cell life and cycling .....	322
effects of temperature on discharge rate .....	320
gassing behavior under pressure .....	329
gassing hazards .....	324
hydrogen generation .....	324
in-hull location .....	326

	Page
pressure-resistant pods .....	327
pressure compensated .....	328
system design .....	328
design considerations on vehicle dynamics .....	330
pressure effects .....	330
biological effects .....	330
silver-zinc, discharge characteristics at high pressures .....	322
life characteristics .....	323
spill angle .....	323
temperature, discharge rate and performance relationships .....	321
voltage profiles .....	321
<b>BEAVER</b> .....	56, 64
described .....	103
control arrangements .....	400
horsepower vs. electric power .....	397
manipulator characteristics .....	532
trim system components .....	307
Beebe, William .....	32
Belgium National Fund for Scientific Research .....	127
<b>BEN FRANKLIN</b> .....	57, 60, 64
ballast system .....	288
described .....	105
drag cable .....	296
electrical penetrators .....	342
hull construction .....	250
life support system .....	260-265
personnel emergency escape scenario .....	661
shot drop system .....	299
temperature variations (in-hull) during Gulf Stream Drift .....	429
tracking system .....	501
water trim system .....	302
<b>BENTHOS V</b> .....	44
described .....	107
<b>BENTHOSCOPE</b> .....	38
Berger, James .....	484
Blair, Wesley .....	449
Bornmann, Robert .....	427
Bottom Mapping Instruments .....	548
side scan sonar .....	548
sub-bottom profiler .....	548
stereophotographic system .....	548
Bottom Sampling Devices .....	550
Boylan, Lee .....	10
Boyle's Law .....	284
Bradley, Robert .....	608
Brazosport College .....	213
Brow .....	7
Buoyancy requirements .....	16
Bushnell, David .....	1
Butenkoff, G. .....	
Cables, electrical, .....	351
designs in use .....	352
failure modes .....	353

	Page
Cable-to-Surface, umbilical .....	334
<b>CALYPSO. R/V</b> .....	42
Canadian Dept. of the Environment .....	187
Canadian Forces .....	191
Carbon dioxide .....	419
absorbant compound characteristics .....	421
chemical compounds for removal of .....	419
effects of temperature, humidity and absorbant bed configuration .....	424
on removal rate .....	424
effects on humans .....	420
molecular sieve removal system .....	424
recommended limits .....	419
scrubber system performance recommendations .....	420
source, rate of build-up, removal .....	419
<b>CEMA</b> .....	60
Center of buoyancy, defined .....	16
changes during submergence .....	17
Center of gravity, defined .....	16
Centre D'Etudes Marine Avances .....	60, 96, 211
Central Research Institute of Fisheries Information and Economics, USSR .....	10
Centre National pour l'Exploitation des Oceans .....	61, 95, 96, 211
Certification .....	636
Canada .....	648
Japan .....	648
U.S. Navy requirements .....	636
construction and fabrication .....	638
instruments, external .....	639
operability and maintenance .....	639
operational safety .....	644
operator competency .....	642
quality assurance .....	638
records .....	637
scope of certification .....	637
survey .....	639
tenure .....	639
testing .....	638
Challenger Deep .....	233,484
Charle's Law .....	282
Chlorate candles .....	669
<b>CHIHRO</b> .....	81
Circuit design, considerations .....	356
distribution .....	356
voltage and amperage requirements, typical outbound components .....	359
Classification, American Bureau of Shipping .....	644
ballast system .....	645
buoyancy characteristics .....	645
calculations required .....	645
drawings required .....	645
maneuverability and control .....	646
stability and trim .....	645
Clausner, Edward .....	700
Closed circuit breathing, emergency use of .....	668
Coast Guard, requirements .....	646



	Page
Rescue and Control Centers .....	647
Collapse depth, defined .....	76
Communications .....	488
by, hardware .....	493
by, sound-power .....	494
“Donald Duck” effect .....	493
factors affecting .....	493
sub-surface .....	492
surface .....	488
Compressed air and deballasting, definition of terms .....	282
Compressed Gas Association .....	274
Concrete, application in pressure hulls .....	250
Connector (electrical) designs, metal shell .....	346
molder elastomer .....	349
molded plastic .....	349
underwater disconnectable .....	350
failure modes .....	345
Conversion factors .....	713
Cook, Roger .....	509
Cousteau, Jacques .....	5, 36, 40, 370
<b>CRAB</b> .....	10
Crosby, E. ....	199
CTFM Sonar .....	469
<b>CUBMARINE</b> .....	2, 43
Cunningham, Frank .....	377, 397
Current meters .....	548
<b>CURV</b> .....	53
<b>CURV III</b> .....	705
<b>CYANA</b> .....	211
<b>DAWN STAR. M/V</b> .....	583
Deep Dive Systems MkI & II .....	701
<b>DEEP DIVER</b> .....	56, 64
described .....	109
electrical penetrators .....	340
trim system .....	304
<b>DEEP JEEP</b> .....	47
described .....	111
<b>DEEP OCEAN SURVEY VEHICLE</b> .....	50
Deep Ocean Technology Program .....	338, 346
publications .....	9
<b>DEEP QUEST</b> .....	54
cable handling program .....	354
chemical dumping ground inspection .....	574
dynamic and static maneuvering .....	23
electrical penetrator design .....	257
jettisonable components .....	26
pilots control panel .....	490
rudder and dive plane arrangement .....	378
system described .....	20-28
vehicle described .....	113
<b>DEEP SUBMERGENCE RESCUE VEHICLE</b> .....	62, 64
described .....	125

	Page
failure modes in air transportation .....	578
rescuee requirements .....	698
rescue scenario .....	606
rudder and dive plane/shroud arrangement .....	378
vehicle control arrangement .....	402
<b>DEEP SUBMERGENCE SEARCH VEHICLE</b> .....	63
cable research program .....	354
Deep Submersible Systems Project .....	45
Deep Submergence Systems Review Group .....	45
Deep Submersible Pilots Assoc. ....	10, 643
<b>DEEP VIEW</b> .....	47, 65
described .....	121
hull construction .....	254
<b>DEEP VOYAGER</b> .....	60
<b>DEEPSTAR</b> .....	44
<b>DEEPSTAR-2000</b> .....	59
described .....	115
<b>DEEPSTAR-4000</b> .....	51, 63
ascent/descent ballasting system .....	294
described .....	117
inflatable hatch trunk .....	673
oxygen supply system .....	414
viewport arrangement .....	454
<b>DEEPSTAR-20.000</b> .....	62, 63
corrosion control program .....	275
described .....	119
<b>DENICE</b> .....	5, 207
Density and temperature as a function of ocean depth .....	14
Department of the Interior .....	44
Department of Transportation .....	282, 414
Depth indicators, factors affecting accuracy .....	483
Bourdon tube .....	481
resistance type pressure transducer .....	482
sonic devices .....	484
strain gage pressure transducers .....	482
Dickman, Burtis .....	40, 131
Differential pressure gage .....	486
Diesel-electric power generation .....	336
Dill, Robert F. ....	556
Directional antennae .....	518
Directional gyrocompass .....	507
Dive planes .....	377
Divers, role in submersible rescue .....	700
<b>DIVING SAUCER</b> .....	40, 48, 207
Doppler Sonar .....	508
Dostal, Paul .....	424
<b>DOWB</b> .....	56
described .....	123
propulsion arrangements .....	373
trim system components .....	307
viewing arrangements .....	459
Draeger Multi-Gas Detector .....	435
Drag .....	392

	Page
form drag -----	392
skin friction drag -----	393
Drebel, Cornelius -----	1
Dry weight, defined -----	76
<b>DS-2</b> -----	207
<b>DSV-3</b> -----	193
<b>DSV-4</b> -----	193
Effective horsepower, defined -----	396
Electric Power, application in submersibles -----	313
interference -----	315
terminology and general considerations -----	314
<b>EMERALD STRAITS, M/V</b> -----	573
Emergencies, avoidance devices and procedures -----	651
automatic deballasting -----	655
buoys -----	655
depth gages -----	653
echo sounders -----	656
life support monitors -----	657
pingers -----	658
scanning sonar -----	655
surface support/communication systems -----	558
transponders -----	659
underwater telephones -----	679
corrective devices and procedures -----	659
equipment jettison -----	660
fire control -----	666
flood control -----	666
high pressure ballast tank blow -----	660
inflatable bags -----	665
life support failure/toxic gasses -----	430
manual deballasting -----	660
personnel egress -----	660
power loss -----	669
pressure hull release -----	665
releaseable capsule -----	665
trim fluid drop -----	660
weight drop -----	659
design considerations for:	
deballasting loss -----	19
entanglement -----	19
fire and noxious gasses -----	19
power loss -----	19
tracking loss -----	19
devices and procedures, vehicle-by-vehicle -----	652
incidents -----	685
accidental ballast weight drop -----	686
accumulation of sediment -----	691
buoy entanglement -----	686
collision with bottom -----	691
dam inspection -----	692
during salvage -----	694
electrical fire -----	690
entanglement -----	686
fish attack -----	691

	Page
grounding -----	694
launch/retrieval -----	692
loss of electrical power -----	689
loss of routine ballasting -----	686
operating in Naval exercise areas -----	692
overpowering water currents -----	692
sea state -----	694
sea water density changes -----	691
separation from support craft -----	690
underwater collision -----	686
surface devices and procedures -----	670
anchors -----	672
breathing gas expired -----	672
flashing light -----	671
inflatable hatch trunk -----	673
inflatable modules -----	673
life rafts -----	672
radio signals -----	671
radio transceivers -----	670
rockets and flares -----	671
snorkel -----	675
underwater telephone -----	671
Environmental factors influencing vehicle design: -----	14
acoustics -----	15
ambient light -----	14
bottom conditions -----	16
conductivity -----	14
currents -----	15
density -----	15
pressure -----	14
sea state -----	15
temperature -----	14
Equilibrium, states of -----	16
Exostructure, defined -----	263
Experimental Diving Unit -----	36
External attachments, design considerations -----	18
External structures -----	263
exostructures -----	263
design considerations -----	264
joining to pressure hull -----	264
fairings -----	265
advantages vs. disadvantages -----	265
purpose -----	265
Fail-safe deballasting -----	36
FAMOUS Program -----	212
Farrow, Doug -----	11
<b>FNRS</b> -----	35
<b>FNRS-2</b> -----	35
described -----	127
<b>FNRS-3</b> -----	38
described -----	129
Fofonoff, N.P. -----	483
Fonds National de la Recherche Scientifique -----	35

	Page
Food and water .....	416
Forman, Willis .....	65, 249, 255
Fouling, rate of on <b>BEN FRANKLIN</b> .....	540
Fracture mechanics analysis .....	276
French Naval Shipyard .....	129
French Navy .....	95, 127, 129, 133
Fuel cells .....	331
Fulton, Robert .....	2
Gage pressure (psig), defined .....	282
Gagnan, Emil .....	36
Galatin, I.J. ....	51
Galerie, Andre .....	703
Gas cylinders, color coding .....	283
<b>GASPERGOU</b> .....	175
Gaul, Roy .....	608
Germanischer Lloyds .....	337, 648
Glass, Charles .....	646
Glass, in pressure hulls .....	249
<b>GLOBULE</b> .....	82
<b>GOLDFISH</b> .....	40
described .....	131
Gravity measurements .....	552
<b>GRIFFON</b> , described .....	133
Groupe d'Etudes et de Rescherches Sou-marines .....	133
Guiltisen, Professor .....	37
<b>GUPPY</b> .....	61
described .....	135
trim system .....	306
umbilical power system .....	335
<b>GYRE, R/V</b> .....	182
Habitability .....	449
Habitats .....	5
Haigh, Kenneth R. ....	361, 648
Haight, D. ....	159
Hair, James .....	424
<b>HAKUGEI</b> .....	82
<b>HAKUYO</b> .....	66
described .....	137
Halley, Edmund .....	1
Hardware inspection, devices and techniques .....	571
Hazards, potential for, from:	
bottom hardware .....	634
cables .....	632
explosive ordinance .....	635
instruments .....	627
launch/retrieval systems .....	628
materials and sub-systems .....	626
operator .....	627
sub-surface traffic .....	635
surface traffic .....	635
wrecks .....	633
Headley, Larry A. ....	61
Helium Hard Hat, Mk V .....	701

	Page
Heele, James R. -----	43
Henson, G.S. -----	70
<b>HIKINO</b> -----	47, 55
described -----	139
Hokkaido University -----	149
Homing, by: -----	512
acoustic reflectors -----	514
marker buoys -----	513
passive and active acoustic targets -----	513
pingers -----	515
transponders -----	515
Hood Inflation System, Royal Navy -----	661
Horsepower, defined -----	396
Horton, Thomas -----	58, 70
Houot, George -----	38
<b>HUDSON HANDLER, M/V</b> -----	598
Hull penetrations -----	255
dive planes and rudders -----	258
electrical -----	257
hatch shafts -----	258
hatches -----	256
hull ventilation -----	258
manipulators -----	258
piping -----	262
propellers and thrusters -----	258
reinforcement, for -----	255
viewports -----	258
weight drop shafts -----	258
Human design considerations -----	18
fatigue -----	19
food and water -----	18
respiration -----	18
temperature and humidity -----	18
waste management -----	19
Human Element Range Extender -----	427
Human wastes, nature and storage -----	427
Humidity control -----	430
Hydrocap -----	325
<b>HYDROLAB</b> -----	56, 333
Ianuzzi, A. P. -----	606, 608
Inoue, Naoichi -----	40
Institut Francais du Petrole -----	61, 96
Instruments, constraints on design and application -----	538
failure mode examples -----	542
interference with data -----	361
acoustic -----	363
electric -----	364
scientific and work -----	537
Insurance requirements -----	648
Integrated Control and Display -----	402
Japan Ship's Machinery Development Assoc. -----	648
Japanese Ministry of Transportation -----	648
<b>JIM</b> , described -----	141

	Page
<b>JOHNSON, R/V</b> .....	143
<b>JOHNSON-SEA-LINK</b> .....	65
air conditioning .....	430
described .....	143
Johnson, Seward .....	65
Junction boxes .....	355
<b>K-250</b> .....	55
described .....	145
life support system .....	438
Kittredge, G. W. ....	55, 438
Kort, Ludwig .....	372
Krasberg, Alan .....	433
<b>KUMUKAHI</b> .....	60
described .....	147
<b>KUROSHIO I</b> .....	40, 150
<b>KUROSHIO II</b> .....	40, 42
described .....	149
power generator/umbilical characteristics .....	335, 336
<b>LA SOUCOUBE PLONGEANTE</b> .....	207
Laboratory of Underwater Research Technique, USSR .....	10
Launch/Retrieval Systems: .....	592
articulated boom .....	596
baloon assist .....	613
catamaran .....	601
centerwell .....	611
constant tension .....	608
docking well lift .....	601
drawbridge .....	608
elevator .....	606
floating dock .....	606
guiding chute .....	613
hinged ramp .....	698
inflatable ramp .....	611
inverted U-frame .....	604
LARP .....	604
non-articulated boom .....	596
open stern-well .....	601
overhead rail .....	598
quick snatch .....	614
rope net catch .....	615
spar buoy with trolley .....	611
stern crane-ways .....	606
stiff-leg boom .....	608
submarine .....	604
submerged platform .....	604
telescoping boom .....	608
telescoping cylinder .....	614
selection parameters .....	595
LaCoste & Romberg Gravimeter .....	553
LaPrier, Cdr. ....	36
Lake, Simon .....	2, 626
<b>LARP</b> .....	604
Letich, M. ....	645

	Page
Life support, defined .....	76
characteristics and instruments, vehicle-by-vehicle .....	417
endurance, defined .....	76
endurance, vehicle-by-vehicle .....	677
Lift hooks .....	615
Light, attenuation, absorption, scattering in sea water .....	471
source characteristics .....	477
transmission, measurement of .....	547
Lighting, experiments by Dillingham Corp. ....	475
experiments by NURDC .....	476
inside pressure hull .....	462
mercury vapor .....	473
thallium iodide .....	413
underwater .....	473
Link, Edwin A. ....	64, 143, 379
Link Park, Fla. ....	109
Lloyds Register of Shipping .....	648
Lockout submersibles .....	18
<b>LRT</b> .....	594
<b>LULU, DSRVT</b> .....	601
Magnetics, measurement of .....	552
Main propulsion, defined .....	377
<b>MAKAKAI</b> .....	47, 65
described .....	151
electro-hydraulic propulsion system .....	391
inflatable buoyancy modules .....	673
propulsion devices .....	373
variable ballast system .....	292
Makapuu Oceanic Center .....	60
Maneuverability, requirements in design considerations .....	18
Maneuvering, rotational/translational motions .....	371
by propulsers only .....	383
by propulsers, rudders and planes .....	385
Manipulators .....	519
claws .....	531
control devices .....	531
defined .....	77
design and capabilities .....	525
design considerations .....	531
electro-mechanical <i>vs.</i> electro-hydraulic actuation .....	526
motions .....	520
power .....	523
terminology .....	520
Manned submersibles, defined .....	5
Manned Undersea Science and Technology Program .....	9, 69, 557
Manual power, applications in submersibles .....	309
Mare Island Shipyard .....	235
Marine Sciences Center .....	65, 143
Marine Technology Society .....	288, 648
Undersea Vehicle Committee .....	409
Undersea Vehicle Safety Standards Committee .....	271
Maritime Safety Agency, Japan .....	203
<b>MAXINE D. M/V</b> .....	583



	Page
<b>MERMAID I/II</b> .....	66
described .....	153
<b>MERMAID III/IV</b> .....	66
described .....	155
Metacenter, defined .....	16
Metacentric height, defined .....	17
<b>MIDWIFE M/V</b> .....	59
<b>MINI DIVER</b> , described .....	157
Min-o-lung .....	668
<b>MIZAR, USNS</b> .....	59
short baseline tracking system .....	502
<b>MOANA I/II</b> .....	82
Monod, Theodore .....	38
Motor Boat Safety Act .....	623
Motors .....	388
ac vs. dc power .....	389
hermetically sealed .....	391
open-winding, oil-filled .....	390
open-winding, water-filled .....	390
<b>MUTE</b> .....	2
Mutual Assistance Rescue and Salvage Plan .....	647
Nani, Menotti .....	34
National Aeronautics and Space Administration .....	60
National Council on Marine Research and Engineering .....	54
National Geographic Society .....	34, 48
National Marine Fisheries Service .....	370
National Oceanic and Atmospheric Administration .....	9, 416
recommended life support duration .....	412
National Search and Rescue Plan .....	647
National Technical Information Service .....	370
<b>NAUTILETTE</b> .....	45
described .....	159
<b>NAUTILUS</b> .....	2
Naval Applied Science Laboratory .....	249
Naval Electronics Laboratory .....	39, 556
Naval Oceanographic Office .....	2, 6, 50
Naval Ordnance Laboratory .....	706
Naval Ordnance Test Station .....	45, 111
Naval Ships Research and Development Center .....	270, 297
Naval Ships System Command .....	637
Naval Weapons Center .....	55, 139
Navigation, <i>see also</i> Homing Systems, by: .....	494
bottom mounted acoustic systems .....	510
dead reckoning .....	505
gyrocompass .....	504
magnetic compass .....	505
marker buoys .....	498
surface tracking systems .....	496
active sonar ranging .....	497
pinger-hydrophone systems .....	498
pinger transponder—hydrophone/interrogator .....	501
short baseline system .....	502
visible markers .....	505

	Page
Navy Civil Engineering Laboratory .....	61, 163, 250, 258
Navy Diving and Operations Manual .....	282, 424
Navy Material Command, recommended oxygen concentrations .....	412
Navy Undersea Center .....	65, 121, 151, 163
<b>NEKTON ALPHA</b> .....	55
<b>NEKTON ALPHA, BETA, GAMMA</b> , described .....	161
manipulator characteristics .....	530
role in rescue .....	571
<b>NEMO</b> .....	47, 61
air conditioning system .....	430
anchoring system .....	294
described .....	163
hull construction .....	253
viewing arrangements .....	457
<b>NEREID 330</b> .....	65
described .....	165
manipulator characteristics .....	528
<b>NEREID 700</b> .....	65, 165
Newcastle University .....	406
Newman, John .....	506
New York Zoological Museum .....	32
Nicholson, W.M. ....	420
Noise, effects on operator .....	462
Nonsuch Island, Bermuda .....	34
<b>NR-1</b> .....	60, 334
Normal temperature and pressure (NTP), defined .....	282
Nuclear power .....	334
Observers, defined .....	76
<b>OCEAN FLEAS</b> .....	209
Oceanic Foundation, Makapuu Point .....	147
Oceanic Institute, Makapuu Point .....	147
Office of Naval Research .....	39
Open circuit breathing, emergency use of .....	667
Operational instruments and devices (vehicle) .....	467
Operational safety .....	644
Operating depth, defined .....	76
Operating/scientific equipment, defined .....	76
Operator, defined .....	7
USN definition .....	642
<b>OPSUB</b> , described .....	167
<b>ORTOLANE (ASR-22)</b> .....	703
Oxygen concentration, effects on humans .....	412
concentrations recommended by MTS .....	412
control of flow .....	414
external/internal storage requirements .....	412
liquid, advantages of .....	416
recommended storage flask pressures .....	414
replenishment .....	412
sensor, sea water .....	544
Pallange, George .....	357
<b>PAULO I</b> .....	64
described .....	169
Payload, defined .....	76
requirements in design .....	18

	Page
<i>PC-X</i> .....	176
<i>PC3-A</i> (1&2) .....	45
described .....	171
<i>PC3-B</i> .....	43, 50
described .....	173
rudder and dive plane arrangement .....	378
<i>PC3-X</i> , described .....	175
<i>PC5-C</i> .....	55
described .....	177
<i>PC8-B</i> , described .....	179
viewing arrangements .....	458
<i>PC-9</i> .....	229
<i>PC-1201</i> .....	83
<i>PC-1202</i> .....	83
<i>PC-14</i> , described .....	181
vehicle control arrangements .....	399
<i>PC-1402</i> .....	83
<i>PC-15</i> .....	237
<i>PC-16</i> .....	83
Penetrators, (electrical) types .....	338-344
hull entry angle .....	344
hull fastening method .....	344
hull sealing methods .....	344
insert types .....	344
molded gland type .....	342
Perry, John .....	2, 43
Personnel and shore facilities .....	617
Personnel Transfer Capsule .....	661
Peyzer, Richard .....	647
Philadelphia Maritime Museum .....	215
<b>PHOENIX 66</b> .....	71, 337
Photography, underwater .....	554
Piccard, Auguste .....	34, 296, 487
Piccard, Jacques .....	38, 39, 48, 57, 483
<b>PIGEON (ASR-21)</b> .....	703
Pilot .....	7, 76
Pinging, defined .....	498
<b>PISCES I</b> .....	52
described .....	183
role in tugboat salvage .....	573
torpedo retrieval .....	557
<b>PISCES II</b> , described .....	185
modifications for North Sea .....	406
<b>PISCES III</b> .....	60, 68
described .....	185
manipulator characteristics .....	528
rescue events and facilities .....	707
<b>PISCES IV</b> , described .....	188
<b>PISCES IV/V</b> .....	64
V, described .....	187
<b>PISCES VI</b> .....	83
<b>PISCES VII</b> .....	83
<b>PISCES VIII</b> .....	83

	Page
<b>PISCES X</b> .....	83
<b>PISCES XI</b> .....	83
Pitch/roll indicators .....	488
<b>PLC-1</b> .....	109
<b>PLC-4B</b> .....	201
Pneumatic, power application in submersibles .....	310
<i>see also</i> : deballasting and compressed air .....	282
<b>PORPOISE</b> .....	84
Potassium superoxide .....	424
Power, electrical .....	17
Power distribution .....	338
Power source, defined .....	76
characteristics, vehicle-by-vehicle .....	311
evaluation criteria .....	316
cost .....	318
maintainability and repair .....	318
operational handling .....	318
reliability .....	318
total requirements .....	316
weight and volume .....	316
Power spectrum analysis .....	317
Pressure compensation fluids .....	332
Pressure hull, defined .....	76
depth and payload as affects configuration and materials .....	245
fabrication procedures .....	250
adhesives .....	253
bolting .....	253
clamping .....	254
glass-to-metal bonding .....	254
welding .....	250
materials .....	247
chemical analyses of steels .....	249
measurements and tests .....	271
strain gages .....	272
tests program for <b>ALVIN</b> .....	272
volumetric testing .....	274
properties .....	247
brittle fracture .....	247
corrosion .....	247
creep .....	247
ductility .....	247
formability .....	247
fracture toughness .....	247
low cycle fatigue .....	247
reproducibility .....	247
stress-corrosion cracking .....	247
stress-relief embrittlement .....	247
weldability .....	247
shape .....	241
advantages and disadvantages of various configurations .....	245
basic configurations .....	246
potential configurations and W/D ratios for <b>DSRV</b> .....	245
materials and depth, vehicle-by-vehicle .....	242

	Page
Pressure testing, general considerations	266
Pressure test facilities	276
Pritzlaff, John	685
<b>PRIVATEER, M/V</b>	60
Privitt, Douglas	395
Project FAMOUS	70
Project GULFVIEW	53
Project NEKTON	39
Project TITANES	351
Propulsion/control devices, defined	76
Propulsion devices, cycloidal propellers	373
ducted propellers	372
free propellers	371
kort nozzels	372
tandem propulsion	375
varivec propulsion	377
water jets	375
Propulsion power requirements	395
Pruna, Andres	555
<b>PRV-2</b>	84
<b>PS-2</b> , described	189
Psychological aspects	463
Psychrocycle	337
Psychrodiesel	337
<b>PUCE DE MER</b>	209
Purcell, John	624
<b>PX-8</b>	101
<b>PX-15</b>	57, 105
<b>QUESTER I</b>	84
Rechnitzer, Andres	39
Rescue, devices to assist underwater retrieval	675
acoustic	680
avoidance sonar	680
environmental sensors	683
external connections (air, gas, elec.)	682
external lights	681
lift padeyes	682
marker buoys	680
telephones	676
Rescue potential, recovery	700
underwater personnel transfer	695
Research instruments	555
application in various projects	558
Respiratory Quotient, derived	419
Reynolds, J. Louis	44, 48
Reynolds number	393
Reynolds, Osborne	393
Rodmeter	488
Rudders	377
Russner, C.	159
Safety features, defined	77
Santa Barbara City College	123
Savonius roter	487

	Page
<b>SCALDIS, M/V</b> .....	38
Scharffenberger, G. T. ....	51
Schlumberger, side wall corer .....	551
splice .....	353
<b>SCORPION, USS</b> .....	63, 511
Scripps Institute of Oceanography .....	111, 219
<b>SCL-1</b> , described .....	191
vehicle control arrangements .....	398
Sea bottom, percent of bottom <i>vs.</i> depth .....	246
<b>SEA CLIFF</b> .....	57
described .....	193
manipulators .....	528
<b>SEA EXPLORER</b> .....	84
<b>SEA HUNTER, M/V</b> .....	592
Sea Life Park, Waimanalo .....	147
<b>SEA OTTER</b> .....	64
described .....	195
manipulator .....	525
rudder and plane arrangement .....	378
<b>SEA RANGER</b> , described .....	197
<b>SEARAY</b> .....	55
described .....	199
Sea state, defined .....	14
as affects operations .....	595
Sea water, density and temperature .....	14
sound speed, in .....	15
Search and rescue, responsibilities for .....	647
Search simulation experiments, <b>DSSV</b> .....	452
<b>SEARCHSTAR, M/V</b> .....	59
<b>SEAMARK, M/V</b> .....	588
<b>SEVERANKA</b> .....	10
Shaft horse power, defined .....	396
derived .....	397
<b>SHELF DIVER</b> .....	56
described .....	201
manipulator .....	528
viewport arrangements .....	456
<b>SHINKAI</b> , described .....	203
Ship of opportunity .....	77
Slant range, defined .....	
Smithsonian Institution .....	65, 109, 143
<b>SNOOPER</b> .....	60
described .....	205
Sonar, acoustic imaging .....	470
CTFM .....	469
echo sounders .....	468
Wesmar scanning .....	469
Southwest Research Institute .....	44, 121, 163, 271
Soviet Academy of Sciences .....	83
Soviet Bloc submersibles .....	10
<b>SP-300</b> .....	207
<b>SP-350</b> , described .....	207
fuel cell experiments .....	334

	Page
propulsion arrangements	375
<b>SP-500</b>	60
described	209
<b>SP-3000</b>	61
described	211
Spanish H-bomb search	42
Speed-endurance, defined	76
Speed indicators	487
<b>SPORTSMAN 300 &amp; 600</b>	43
described	213
<b>SQUALUS, USS</b>	36
Stability, requirements	16
Stabilizers	377
Stachiw, J. D.	249
Standard Man, characteristics	410
Standard temperature and pressure (STP), defined	282
Standoff distance, sample calculations	640, 641
<b>STAR I</b>	43
described	215
fuel cell experiments	331
<b>STAR II</b>	54
described	217
<b>STAR III</b>	54
described	219
personnel emergency escape procedure	663
vehicle control arrangements	399
Strain gage, sample readings on <b>DSRV-2</b>	273
<b>SUB-ROSA</b>	43, 175
<b>SUBMANAUT (Heele)</b>	43
described	221
<b>SUBMANAUT (Martine)</b>	40
described	223
diesel electric system	336
rudder and dive plane arrangement	378
viewport arrangement	456
<b>SUBMARAY</b>	43
described	225
Submarine Development Group One	10, 63, 643
Submarine Rescue Chamber, rescue scenario	699
rescue requirements	699
Submersibles, data sources and references	77
certification, proposed legislation	624
control devices	397
defined by ABS	645
defined by USN	636
descriptive terminology	7
listing, past, present, future vehicles	81
publications of interest	8
rescue devices and techniques	571
retrieval devices and techniques	561
role in rescue	703
status defined	6
Submersible system	5

	Page
design and operational considerations .....	13
Submersible Safety Seminar .....	683
Support and operational costs .....	594
Support considerations, transportation .....	19
launch/retrieval .....	20
platforms .....	19
tracking and navigation .....	20
Support platforms, submersible related equipment .....	592
functions .....	581
representative craft .....	592
Surface support, defined .....	77
<b>SURV</b> , described .....	227
Survey, defined .....	544
instruments: used to conduct; .....	544
weights and dimensions .....	545
<b>SURVEYSUB 1</b> .....	61
described .....	229
<b>SWAN, M/V</b> .....	587
Swimmer delivery vehicles .....	5
Syntactic foam .....	296
<b>TADPOLE-1</b> .....	85
<b>TAURUS</b> .....	85
<b>TECHDIVER</b> .....	173
Television .....	480
low light level .....	481
Temperature and humidity, effects on occupants .....	427
Temperature, control in pressure hull .....	429
layering in pressure hull .....	462
Texas A&M University .....	181
Thompson, M .....	625
<b>THRESHER, USS</b> .....	45
Thrusters, defined .....	377
Tiburon Marine Laboratory .....	213
Time-late, defined .....	707
Todd, M. R. .....	661
Tools, engineering, inspection, salvage .....	557
Toggweiler, Mart .....	43
<b>TOKAI</b> .....	85
Total power capacity, defined .....	76
<b>TOURS 64 &amp; 66</b> .....	66, 336
described .....	231
Trace contaminants .....	426
Transportation, air .....	580
land .....	578
sea .....	579
federal regulatory codes .....	581
<b>TRANSQUEST, M/V</b> .....	590
<b>TRIESTE I</b> , design .....	58
described .....	233
electrical penetrators .....	340
hull reinforcements .....	255
<b>TRIESTE II</b> .....	45
described .....	235



hull construction	254
launch/retrieval logistics	300
<b>Trim</b>	7
defined	76
requirements for	16
systems external to pressure hull	304
ballast weight drop	306
battery shift	306
MBT differential fill	306
mercury transfer	304
oil transfer	307
shot hopper differential fill	306
VBT differential fill	304
water transfer	306
systems inside pressure hull	301
water transfer	302
weight shift	304
systems, vehicle-by-vehicle	306
<b>TS-1</b>	229
<b>TUDLIK</b>	5, 189
<b>TURTLE</b> (Bushnell's)	1
<b>TURTLE</b> (USN)	57
described	193
Udall, Stewart	44
<b>UNDERSEA HUNTER, M/V</b>	586
Underwater telephones	679
Unigator	508
University of Pennsylvania	571
University of Pennsylvania Museum	48
Unmanned vehicles	703
<b>URF</b>	
U.S. Air Force	171
U.S. Army	172
Usury, Dick	593, 615
<b>UZUSHIO</b>	85
Variable ballast systems, vehicle-by-vehicle	286
Vassena, Pietro	39
<b>VAST MKII</b>	145
Vernon, James	625
<b>VICKERS VOYAGER, M/V</b>	183
<b>VICKERS VENTURER, M/V</b>	183
Viewports, conical acrylic plastic	261
flat acrylic plastic	260
properties of glass and plastic	259
recommended design and seals	261, 262
requirements	16
Vigil, Arthur	480
Vincent, C. R.	34
Vine, Alyn	44, 606
<b>VIPERFISH</b>	85
<b>VOL-LI</b>	64
described	237
Volume (free), in various vehicles	450

Wake steering .....	388
Walsh, D. K. ....	353
Walsh, Don .....	39
Washington Navy Yard .....	234
Water sensor pod .....	544
Watson, William .....	551
Weight and volume estimates .....	279
Weight-to-displacement ratio (W/D) .....	241
<b>WHITESANDS, USS</b> .....	300
Willet, F. ....	595, 606
Winget, Clifford .....	9
Wood, in pressure hulls .....	250
Woods Hole Oceanographic .....	8, 91
Worthington, R. K. R. ....	6, 519
<b>YAMAMOTO, M/V</b> .....	240
Yastrebov, V. S. ....	10
<b>YOMIURI</b> , described .....	239
Yomiuri Shimbu Newspaper .....	240

# ADDENDUM

The first proof print of this book was made in November 1974. Since then, the changes in vehicle characteristics/components/instruments and their owners have been substantial. Probably the easiest place to begin is with the purely mechanical corrections; these are:

Page 399—Contronex should read Controlex.

Page 399—**PC-14** has been redesignated **DIAPHUS**, not **TECHDIVER**.

Page 615 and Fig. 12.31—Pelican Hook should read Standard Lift Hook.

Now, owing to the tremendous impact of offshore oil, *i.e.*, the North Sea, on submersible employment and a subsequent gain of knowledge on the author's part, the following corrections and comments are presented in order to provide a semblance of currency to the topic. The most logical approach would seem to be chronologically chapter-by-chapter; this method will be followed.

*Contemporary Submersible Development*—I am indebted to Mr. Motoyoshi Hori of the Japanese Marine Science and Technology Center (JAMSTEC), Yokosuka for supplying me information regarding a 4-man submersible built at Taiwan in 1929 by Mr. Ichimatsu Nishimura. Mr. Nishimura was both designer and funder of this submersible and a follow-on vehicle in 1935. The vehicles were equipped with glass viewports and were built solely for fisheries research and undersea construction. The second was used in search of the H.I.J.M. Submarine I-63 which sunk in a 1939 collision in the Bungo Suido. While strong currents inhibited the vehicle's effectiveness, the Imperial Japanese Navy recognized the potential of these crafts and had two identical vehicles built for salvage-type operations, one of the most noteworthy tasks being the search and investigation of the sunken battleship **MUTSU** near Kure in 1943. According to Mr. Hori, these boats are quite distinct from the midget attack submarines of the Imperial Japanese Navy and were intended for fishing and salvage purposes only. Briefly, the characteristics of the third and fourth submersibles were:

Length:	12.8m
Beam:	1.85m
Draft:	1.80m
Displ.:	20 tons
Operating Depth:	200m
Power Source:	Lead-acid batteries
Propulsion:	2 ea. 16 hp DC motors

From the point of view of modern deep submergence, I believe Mr. Nishimura's 1929 vehicles to be the first contemporary civilian submersible.

*Manned Submersibles 1948-1974*. Little would be gained by again reiterating the changes that have and are taking place on individual vehicles and the field at large. Table 4.1 is as up to date as the publisher will tolerate revisions. Still, some comments are in order to make this Table more accurate.

**ARCHIMEDE**—No longer operational; retired.

**DEEP DIVER**—No longer at Ft. Pierce, Fla.

**DEEPSTAR 2000**—Sold to GO International, Marseilles, France.

**DEEPVIEW**—Being refitted with a plastic bow dome.

**DOWB**—Being refitted with a plastic bow dome.

**DSRV 1 & 2**—Classed as operational.

**GRIFFON**—Operational.

**MERMAID III**—Refitted with plastic bow dome.

*Pressure Hulls and Exostructures*—Not mentioned as an active pressure hull material was fiber reinforced plastic which constituted the entire pressure hull, ballast tanks and conning towers of the **SEA EXPLORER** of Sea Line, Inc. A consistent trend in virtually all newly built vehicles is the inclusion of a plastic bow dome *in lieu* of separate viewports. Many of the older vehicles, as noted above, have been or are being refitted with bow domes.

*Life Support*—Since the advent of **PISCES III** and the **JOHNSON-SEA-LINK** incidents, the life support endurance on a great number of vehicles has increased by orders of magnitude. Vickers Oceanics, Ltd. state at least 7 days/man; Northern Offshore, Ltd. 5 days/man; others have followed suit

to the point where most, but not all, supply at least 72 hours/man. There is a greater tendency towards the use of LiOH as a CO<sub>2</sub> scrubber, but in many cases it is carried in reserve rather than for normal use, while baralyme or soda-sorb is used routinely. Because of the tremendous increase in life support duration on individual vehicles, Table 14.6 should not be regarded as accurate.

*Instruments*—The majority of instrument development is concentrated on work tools rather than scientific devices. This, quite naturally, reflects the nature of the work being performed and anticipated. One of the more active service corporations is Vickers Oceanics, Ltd. A recent brochure of theirs provides an indication of the direction in which work tools and developmental techniques are proceeding; this list includes: Impact wrenches, drills, grinder/cutters, corers (hard rock), chainsaws, guillotines (cutting hawsers, ropes, etc), mud pumps, stud guns, handwheel operators, wire brushing, explosive holecutting, underwater non-destructive testing, reciprocating saws, underwater burning, concrete chippers, and underwater welders. It is evident that engineering and work tools are coming of age.

*Safety Devices/Emergency Procedures*—Changes in this area include not only increased life support, but the appearance of releasable marker buoys that may be used for homing by rescuers; the carrying of protective (*i.e.*, thermal) clothing and underwater telephones with at least one carrier frequency of 8.0875 kHz compatible with Navy UQC. Unfortunately, another submersible-related tragedy occurred in early September 1975 with the **STAR II**. **STAR II** is launched/retrieved with the LRT system (p. 594) which requires the assistance of three ambient divers: 1 to control the LRT depth/buoyancy and 2 to release/attach **STAR II** to the platform. While the incident is still to be fully investigated and reported, it appears that depth control was either unattainable or misjudged, because the sole surviving ambient diver recalls passing the 300 ft. level before he abandoned the LRT and surfaced. The remaining two divers perished. **STAR II** was released and surfaced safely. The incident tragically demonstrates the systems concept of submersibles.







